

Terminal blocks Klippon® Connect

Version 2023

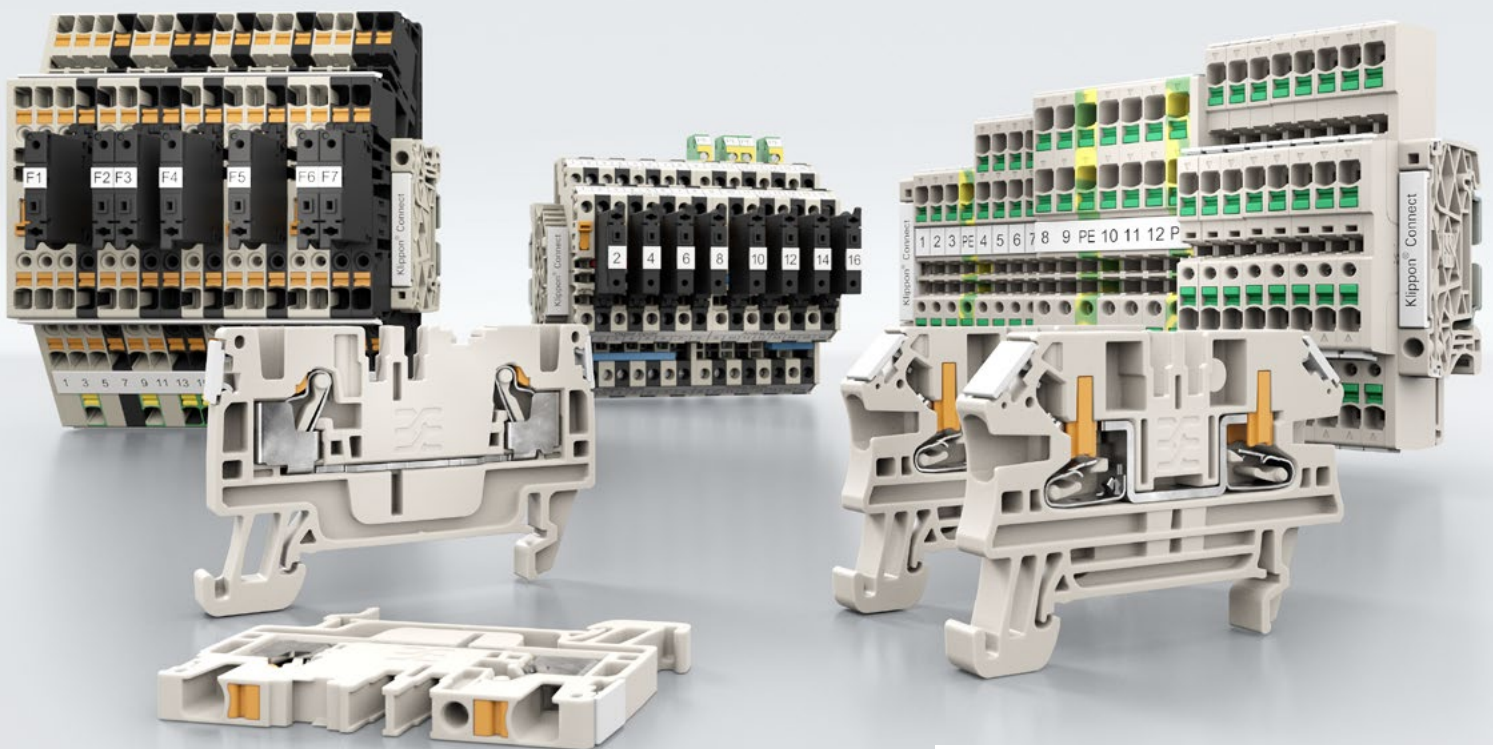

Orange Selection

Quick and easy planning

As a planning engineer, do you want to select products easily and receive them quickly? From a partner you can rely on? Then plan with the Orange Selection from Weidmüller in the future. The Orange Selection items are always available, carefully selected and the portfolio consists of more than 1,500 items to fully cover your standard needs.

If your order is placed before 3:00 pm, we guarantee that your order will be on its way the very next working day.

For even more efficient planning and production processes, we will of course provide all articles in digital form. CAD, ETIM and eClass data are available in our online product catalogue **catalog.weidmueller.com**

We have summarised all the advantages of the Orange Selection on our website.

Check it out: **www.weidmueller.com/orange-selection**



Terminal blocks

Catalogue 1

Terminal blocks

Universal range

Spring connection with SNAP IN technology (S-Series)

Spring connection with PUSH IN technology (A-Series)

Spring connection with tension clamp technology (Z-Series)

Screw connection with clamping yoke technology (W-Series)

Screw connection with stud technology

Application range

Power feed-in

Power distribution

Control voltage distribution

Instrument transformer wiring

Signal wiring

Signal marshalling

Shielding and earthing

Building installation wiring

Installation

Appendix

Service and support

Index

Index Type / Order No.
Addresses worldwide



Extra efficiency in planning, installation and operation

Klippon® Connect provides you with added value at all stages

Panels are key elements of many industrial applications. They transmit signals, control data and distribute power – sometimes under the most adverse of conditions, such as vibrations, dust, cold or extreme heat. What is more, they have to be individually designed and built to suit the requirements and the industries they will be used in. All of the steps in the panel building process are key to increasing efficiency in the long term and exploiting potential for optimisation.

As your partner in Industrial Connectivity, we consider panel building to be an integrated process – from planning through installation to operation. The result is solutions that support products and processes to offer you added value at all stages. Klippon® Connect, our terminal block range, is the best example of this, given that it is another pioneering solution in the field of industrial connectivity.

Our promise

With Klippon® Connect, you benefit from productivity gains throughout the entire panel building process. These include time-saving planning and project planning, faultless wiring and faster marking operations, for example.



Achieving greater productivity one step at a time

Every panel building process starts at the planning stage. It is here that the foundations for optimum set-up are laid. Once there is a plan in place, preparatory work and installation can start. The panel components are marked, wired and checked. The fully installed panel can then be put into operation. To ensure that you achieve the greatest possible level of efficiency in this process, we have continuously examined the optimisation potential of the individual phases of planning, installation and operation and how they interlink with one another. The result is innovative products and services that support you at all the stages of the panel building process.

Up to 75 percent engineering

- Faster planning with the Weidmüller Configurator
- Error-free configuration through compatibility checks on products and accessories
- High level of transparency throughout the entire process thanks to linked data models
- Easy creation of product documentation



High wiring density with maximum ease of installation

- Noticeably faster wiring with PUSH IN technology
- All product functions can be clearly distinguished
- Flexible potential distribution thanks to various cross-connection options
- Faster marking thanks to endless marker strip and large marking surfaces

Higher availability during operation in the long term

- Simpler testing procedure thanks to integrated test point
- Hot rewiring possible without special tools thanks to PUSH IN technology with pushers
- Gas-tight and vibration-resistant connections for interference-free operation
- Flexible, simple modification and extension

Solutions for more productivity

Extremely flexible process design – with Klippon® Connect

Whether it is simple handling, more space in the panel or time saving on installation: Klippon® Connect offers numerous benefits for your process. In line with our range of terminal blocks, we can offer you an application range and a universal range. The particular requirements determine which is the most suitable.

Often, standardisation enables the right solution to be found with our sophisticated, function-oriented universal range. It provides you with practical product features. For recurring application fields, such as control voltage distribution or signal wiring, we offer you the ideal solutions with our application range. Thanks to the high level of application focus, these solutions really do help increase productivity, efficiency and safety. And when tailored configuration is required, our customer-specific assembly service is available.

Our promise

With Klippon® Connect, we offer a comprehensive range of terminal blocks for high levels of productivity in your panel applications.

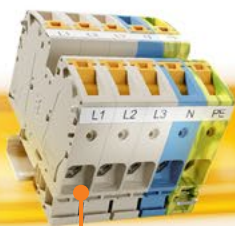

Power feed-in



Power distribution



Control voltage distribution



Current and voltage transformer wiring

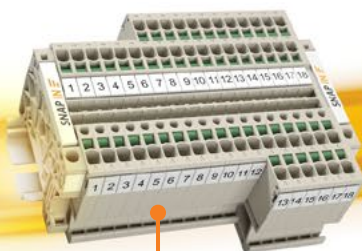

Spring connection with SNAP IN technology



Spring connection with PUSH IN technology



Spring connection with tension clamp technology

Building installation wiring

Shielding and earthing

Signal marshalling

Signal wiring

Screw connection with stud technology

Screw connection with clamping yoke technology

The Klippon® Connect universal range is a complete range of standard products including all conventional connection technologies and functions.

The application range - application-specific and tailor-made

The universal range - flexible and versatile to use

The Klippon® Connect universal range is a complete range of standard products including all conventional connection technologies and functions.

From intelligent item data to the finished panel

Weidmüller Configurator: simpler configuration and ordering

Digital information is becoming increasingly important during product development. Starting with the product selection, configuration and creation of a virtual prototype through to the automated production and installation, end-to-end available data models are a cornerstone of digital production. This requires standardised product data and interfaces between the energy tools networked together and integration into the corporate IT environment. The “Weidmüller Configurator” software forms the ideal basis for end-to-end transparent panel planning.

Our promise

The Weidmüller Configurator speeds up panel planning by up to 70 percent, thus increasing productivity. You can benefit from high levels of data transparency and availability throughout the entire engineering process.

Integrated digital planning – quick and simple

Provision of intelligent item data

The product data from the software provide comprehensive support in configuration and can be fully integrated into all conventional engineering tools. The complete data transparency and availability across all process phases are a basic prerequisite for the implementation of Industry 4.0 in future panel building.

Simple and secure labelling

The Weidmüller Configurator enables virtually labelling of your whole project. Thanks to direct interfaces to CAD programs and the M-Print® PRO labelling software, you can plan and label your components in a single step.

Always the right configuration

The automatic filter function provides active assistance in putting together terminal blocks by preventing and automatically correcting incorrect assemblies. You can only add selected fitting accessories to your current configuration. This makes planning easier and saves a huge amount of time. At the same time, you can benefit from seamless documentation of your assembled terminal rails.

Fast and simple product enquiry

Once you have found your perfect combination, you can enquire about the components directly from the software – either as individual components or as a pre-assembled complete solution on a DIN rail which then only needs to be fitted to the mounting plate.

**Get started online now!**

The Weidmüller Configurator makes configuration easy. Visit our website and make the most of the wide range of benefits for your engineering process.

Full information on the software can be found here:

www.weidmueller.com/wmc

Tailor-made terminal strips

Flexibly designed to suit your requirements

Your processes in panel building have to be fast, flexible and productive. This is the only way you can cut your costs and increase efficiency. Depending on the application in question, you will have different requirements with respect to the engineering service, delivery speed and flexibility to be provided.

From ready-specified strips that are immediately available from stock, through simple configurations with a short delivery time, to complex solutions with a high engineering requirement, we can respond flexibly to your needs. Simply talk to our sales staff, so that, together, we can head off in the right direction for your project.

Our promise

We believe that custom work is the perfect interaction between the product and the service. Both of these elements combine to form a single unit that guarantees the very best quality and thus satisfied customers, even when it comes to the terminal strips.



1.

Defining the task

We support you right from the start:

- Actual analysis
- Project definition

2.

Advice

Individually to suit your needs:

- Over the phone and on site
- Application-specific product selection
- In-depth dialogue

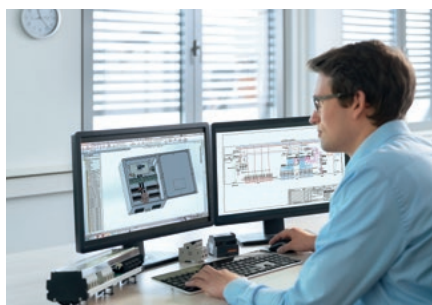

Product and service – perfectly coordinated to one another

However your product is designed, at the end of the day you can rest assured that you are using the best solution. Simply tell us what you would like, and we will make it happen:

- Selection of materials for the terminal rails: steel, stainless steel, aluminium or plastic
- Machining the terminal rail: cutting, punching and attaching a wide range of different mounting aids
- Assembling the terminal strips with snap-on components (terminal blocks and electronic products, as well as additional products from other manufacturers as required)
- Establishing cross-connections
- Fitting standard conductors
- Marking terminals, devices, conductors and cables



4.

Production, logistics, documentation

Everything from a single source:

- Production technology
- Inventory management
- Comprehensive documentation as per the customer's requirements

3.

Application-specific development

The foundation for your success:

- Joint solution development
- Bespoke configuration
- Sample production

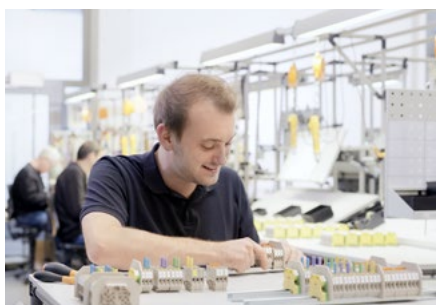

Service connects

You will find information about other services from Weidmüller at:

www.weidmueller.com/service

Klippon® Services – focus on your core business

„Fast Delivery Service“ enables the delivery of assembled products at short notice, even with Ex approval

Today you are confronted with tough challenges in mechanical and plant engineering as well as in control cabinet production. On the one hand, the production of your products is becoming increasingly made to order/ custombuilt and a lot more complex. On the other hand, you have to deal with high price pressures, tight deadlines and short-term change requests. In addition, many products are requested in small quantities.

To meet these growing demands, you need ever more efficient planning and manufacturing processes - and you need to be able to rely on 100% fast and reliable delivery. With our Fast Delivery Service, we offer you both. The integrated concept simplifies your planning, accelerates your manufacturing processes and guarantees the delivery of individually assembled and ready-to-install terminal strips or enclosures within the shortest possible time. In this way, you reduce your costs, increase your flexibility and stay one step ahead of your competitors.



Klippon® Connect and Klippon® Protect

Assembled enclosures with terminal strip, add-on components and optional Ex approval.



Klippon® Protect

Individual empty enclosures with holes, threads or cut-outs according to your specifications – optionally unassembled, equipped or with add-on parts.



WMC – Digital Engineering

Our Weidmüller Configurator (WMC) gives you access to the “Fast Delivery Service”. You can import directly your CAE data.

Klippon® Connect

Ready-to-install assembled terminal strips including electronic components - individually manufactured according to your specifications.

Determine your own delivery time thanks to Fast Delivery Service

We offer the choice between 3 service levels

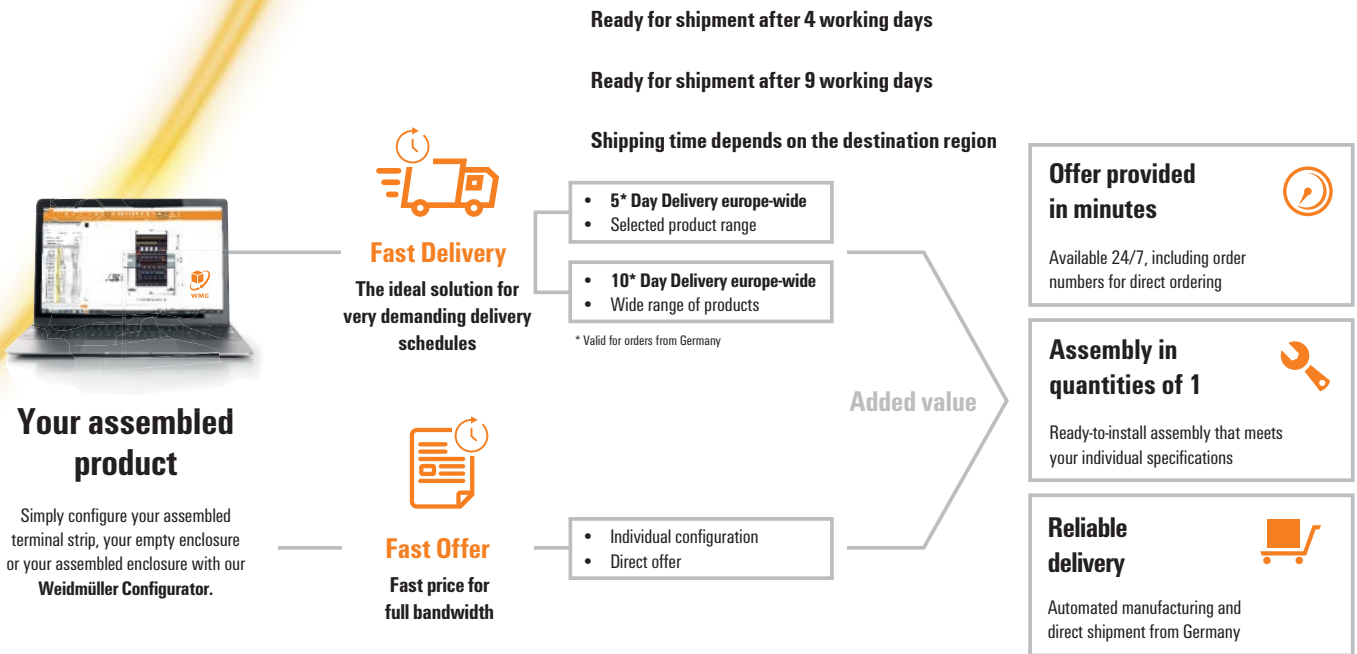

Your advantages at a glance with our Fast Delivery Service



Reduce your costs

Your plants are becoming more and more specific and complex. Therefore, you have to stock many required components in your warehouse. With Fast Delivery, you receive complete assembled products – and can significantly minimise your purchasing and storage costs.



Increase your flexibility

More and more often you have to manufacture small quantities of plants and be prepared for short-term changes. With Fast Delivery, you get individual terminal strips and enclosures from batch size 1 – and you receive them ready for installation. This increases your flexibility.



Meet your delivery commitments

You must complete and deliver your individual plants within tight time frames. Otherwise, your customers face high costs due to delays and production downtimes. With Fast Delivery, you can speed up all your processes and reliably meet your delivery commitments.

Universal range

Universal range	Connection technologies	A.2
	Spring connection with SNAP IN technology (S-Series)	A.4
	Feed-through terminal blocks	A.6
	PE terminal blocks	A.10
	Spring connection with PUSH IN technology (A-Series)	A.14
	Feed-through terminal blocks	A.16
	PE terminal blocks	A.46
	Fuse terminal blocks	A.60
	Test-disconnect terminal blocks	A.66
	Pluggable terminal blocks	A.72
	Terminal blocks with electronic components	A.90
	Terminal blocks with integrated markers	A.96
	Accessories	A.104
	Spring connection with tension clamp technology (Z-Series)	A.120
	Feed-through terminal blocks	A.122
	PE terminal blocks	A.160
	Fuse terminal blocks	A.177
	Test-disconnect terminal blocks	A.192
	Pluggable terminal blocks	A.196
	Terminal blocks with electronic components	A.216
	Accessories	A.226
	Screw connection with clamping yoke technology (W-Series)	A.238
	Feed-through terminal blocks	A.240
	PE terminal blocks	A.272
	Fuse terminal blocks	A.284
	Test-disconnect terminal blocks	A.306
	Pluggable terminal blocks	A.320
	Terminal blocks with electronic components	A.330
	Mini terminal blocks for enclosure wiring	A.336
	Accessories	A.342
	Screw connection with stud technology	A.358
	Feed-through terminal blocks - SRL	A.360
	Feed-through terminal blocks - WF and WFF	A.364
	Feed-through terminal blocks - ST4000	A.380
	Feed-through terminal blocks - HV 2700 and HV 4000	A.384

Application-oriented wiring

Klippon® Connect always offers the right connection technology

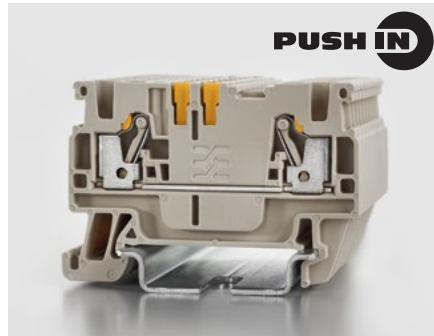
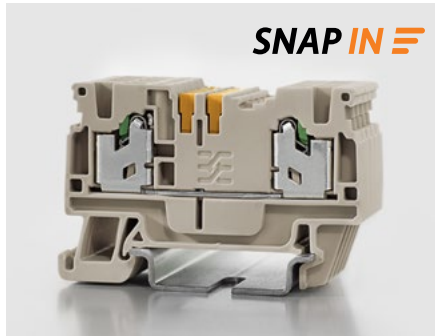

Spring connection with SNAP IN technology



The innovative SNAP IN technology revolutionizes control cabinet construction. The direct connection of

flexible conductors without ferrules reduces conductor preparation and wiring.

Connection principle:

- Significant acceleration of installation and maintenance processes in the field.
- Tool-free, material- and time-saving, as crimping on wire-end ferrules is no longer necessary. Simply insert the flexible or stranded conductor into the open connection point until it „clicks“. Secure connection that reliably withstands even strong shocks and vibrations.

Clamped copper conductors:

- solid
- stranded
- finely stranded
- finely stranded with ferrule with plastic collar
- finely stranded with ferrule without plastic collar
- finely stranded twin ferrule with plastic collar

Connection sizes:

0.5 mm² to 4 mm²

Spring connection with PUSH IN technology



The innovative PUSH IN connection technology reduces the amount of time you spend on wiring to a minimum. The direct plug-in

technology guarantees high conductor pull-out forces and simple handling for all conductor types.

Connection principle:

- With the PUSH IN connection technology, the force on the conductor is generated by a pressure spring made of highquality, acid-resistant stainless steel. The spring sits in a cage and is automatically opened upon connection. The proven Weidmüller system, which separates the mechanical and the electrical function, ensures both high rated data and high conductor pull-out forces.

Clamped copper conductors:

- solid
- stranded
- finely stranded
- finely stranded with ferrule with plastic collar
- finely stranded with ferrule without plastic collar
- finely stranded twin ferrule with plastic collar

Connection sizes:

0.14 mm² to 185 mm²

Spring connection with tension clamp technology



Tension clamp technology is a universal contact system for all common conductor connection types. Its

fantastic level of flexibility makes the tension clamp a profitable alternative connection.

Connection principle:

- The tension clamp system works in a similar way to the proven clamping yoke.
- The tension clamp made of highquality, acid-resistant stainless steel pulls the conductor against the galvanised copper current bar. The surfacetreated current bar permanently provides a low level of contact resistance and a high level of corrosion resistance.

Clamped copper conductors:

- solid
- stranded
- finely stranded
- finely stranded with ferrule with plastic collar
- finely stranded with ferrule without plastic collar
- finely stranded twin ferrule with plastic collar

Connection sizes:

0.05 mm² to 35 mm²

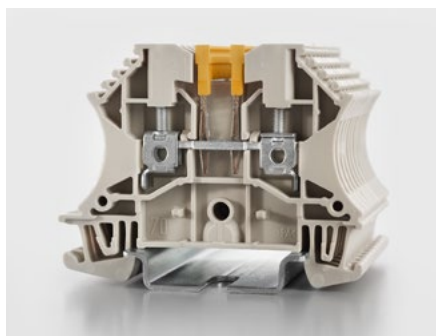

Screw connection with clamping yoke technology



The patented Weidmüller clamping yoke system sets standards. The fact that it is simple to handle makes

clamping yoke technology the universal screwed connection solution for all conductor types.

Connection principle:

- The clamping yoke system combines the specific properties of steel and copper.
- While the clamping yoke and clamping screw are made of hardened steel, the current is made of copper or high-quality copper alloy. The clamping yoke pulls the conductor to be connected against the current bar. Our clamping yoke system is maintenance-free and guarantees vibration-resistant connections.

Clamped copper conductors:

- solid
- stranded
- finely stranded
- finely stranded with ferrule with plastic collar
- finely stranded with ferrule without plastic collar
- finely stranded twin ferrule with plastic collar

Connection sizes:

0.13 mm² to 300 mm²

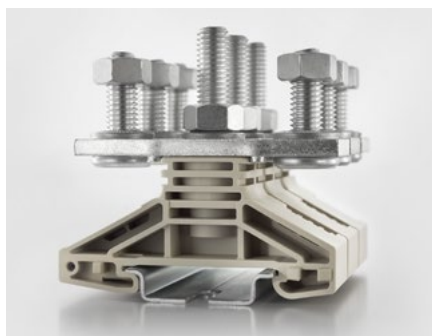

Screw connection with stud technology



With stud technology, you are relying on an affordable and, at the same time, a safe and robust connection

solution for applications in particularly harsh conditions.

Connection principle:

- Cable lugs crimped onto the ends of the conductor ensure a secure connection.
- The cable lugs are put on between the washer on the clamp support and the thrust washer on the stud. The reverse sides of the cable lugs are positioned against one other. Tightening the hexagon nut causes the cable lug flaps to press against one another – thereby creating a secure contact.

Clamped copper conductors:

- According to DIN 46 234
- According to DIN 46 235

Connection sizes:

1.5 mm² to 300 mm²

As fast as a SNAP of your fingers

Klippon® Connect accelerates your wiring with innovative SNAP IN technology

Time is money. For this reason, installation work in control cabinet construction must be carried out ever faster, preferably automated. At the same time, the connections should be permanently reliable, safe, and easy to maintain. The new Klippon® Connect terminal blocks with Weidmüller's revolutionary SNAP IN technology meet all these requirements - and are extremely easy to use: stripped fine-stranded conductors just need to be inserted into the connection point, and the connection point snaps shut with a clearly audible click. The conductor is permanently and reliably contacted. To release the connection, press the green pusher. It couldn't be faster or easier.

Our promise

Klippon® Connect terminal blocks with SNAP IN technology revolutionize control cabinet wiring through their intuitive and simple handling. The reduction in cable preparation accelerates your wiring times and leads to a more efficient installation process.

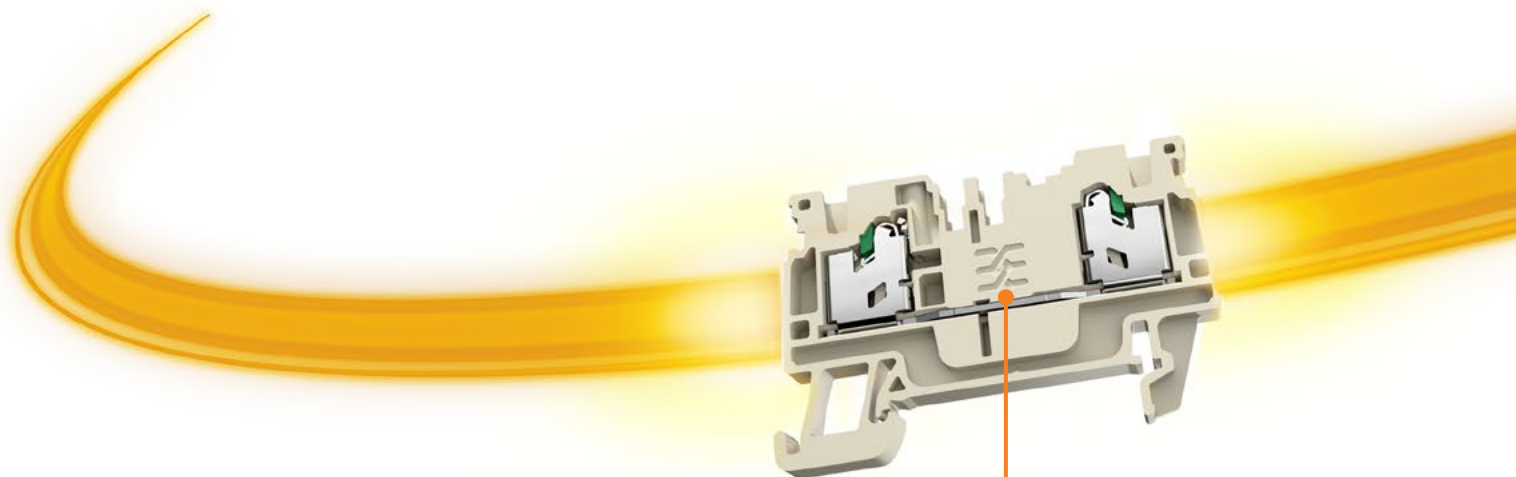

Safety

- Audible click signals correct connection
- Standardised test point
- High contact reliability with lowest mating forces
- Vibration-resistant, gas-tight connection with copper power rails and stainless steel spring

SNAP IN**Flexibility**

- Ideal for the connection of flexible and fine-stranded conductors with and without ferrule
- Release the conductor with any tool
- Large marking surfaces make maintenance
- Compatible with accessories of the Klippon® Connect A series

Time saving

- Intuitive and simple handling of SNAP IN technology
- Low mating forces due to simple insertion of the stripped conductor
- Quick and easy connection even without ferrule
- Clear distinction made between all functional areas

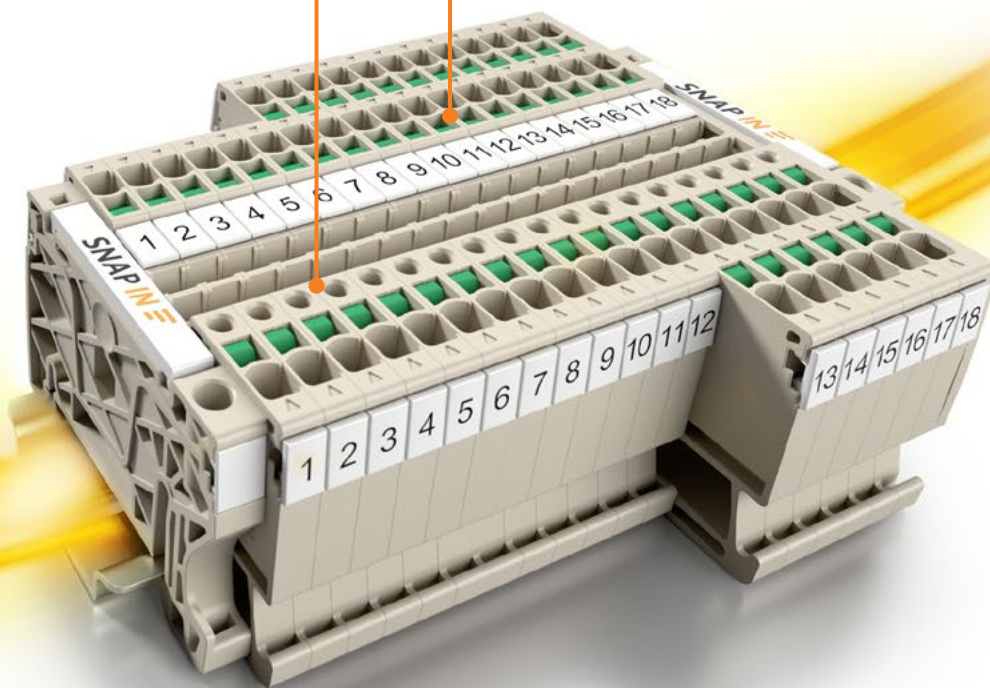
**Overview**

Thanks to the extensive choice of accessories and the different cross-connection options, our SNAP IN terminal blocks are the perfect solution for every requirement.

Compatibility with the A-series:

A terminal rail with the combination of both product families can be realized without any problems. Additional storage costs can be avoided thanks to the uniform accessories.

Everything with only one hand:

The pretensioned clamping point enables the conductor to be contacted quickly with low insertion forces. The SNAP IN technology supports both work with and without ferrules.

Ready for automation:

A clear design and simple handling provide the perfect prerequisites for the automation of your panel design.

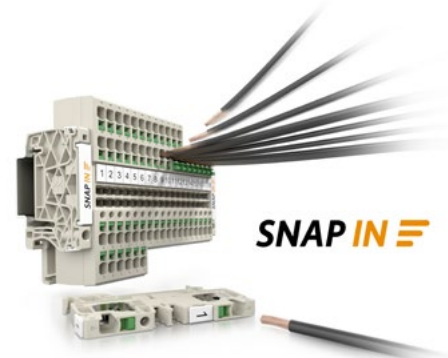

Spring connection with SNAP IN technology (S-Series)

Feed-through terminal blocks



S2C 2.5

2.5 mm²

SNAP IN



S3C 2.5

2.5 mm²

SNAP IN

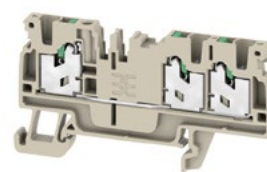

Width/Height/Depth	mm
max. current / max. cond. cross-section	A/mm ²
Max. clamping range	mm ²

5.1 x 59 x 38
24 / 2.5
0.5...2.5



5.1 x 71.5 x 38
24 / 2.5
0.5...2.5



Technical data

Rated data	
Rated voltage	V
Rated current	A
for wire cross-section	mm ²
Rated impulse withstand voltage / Pollution severity	
Gauge to IEC 60947-1 / UL 94 flammability rating	
Approvals	
Clamped conductors (H05V/H07V)	
Solid / Stranded	mm ²
Flexible / Flexible with ferrule	mm ²
Stripping length / Blade size	mm/-
Note	

IEC 60947-7-1

IEC	UL	CSA	EN 60079-7
800	600	600	
24	15	15	
2.5	AWG 20...14	AWG 20...14	
8 kV / 3			
A2 / V-0			

CE

Rated connection	
0.5...2.5 / 0.5...2.5	
0.5...2.5 / 0.5...2.5	
10 / 0.6 x 3.5 mm	

IEC 60947-7-1

IEC	UL	CSA	EN 60079-7
800	600	600	
24	15	15	
2.5	AWG 20...14	AWG 20...14	
8 kV / 3			
A2 / V-0			

CE

Rated connection	
0.5...2.5 / 0.5...2.5	
0.5...2.5 / 0.5...2.5	
10 / 0.6 x 3.5 mm	

Ordering data

Version	
	dark beige
	Blue
	Orange
Note	

Type	Qty.	Order No.
S2C 2.5	100	2674530000
S2C 2.5 BL	100	2753940000
S2C 2.5 OR	100	2875120000

Type	Qty.	Order No.
S3C 2.5	100	2674540000
S3C 2.5 BL	100	2753950000
S3C 2.5 OR	100	2875130000

Accessories

Plug-in cross-connection	
	2-pole
	10-pole
	2-pole
	10-pole
Vertical jumpers	
	1-pole
End plate	
	dark beige
End bracket	
	dark beige, screwable
	dark beige, direct mounting
Test adapter	
	1-pole
	stackable
	3-pole
	5-pole
Test plug	
Screwdriver	
	Standard
Marking tags	

Type	Qty.	Order No.
ZQV 2.5N/2	24 A 60	1527540000
ZQV 2.5N/10	24 A 20	1527690000
Vertical jumpers		
End plate		
SEP 2C 2.5	20	2751080000
End bracket		
AEB 35 SC/1	50	1991920000
AEB 35 SCL/1 V0	20	2661280000
Test adapter		
ATPG 1.5-10 L	0.2 A 50	1991890000
ATPG 2.5 MHR	0.2 A 50	1991960000
ATPG 2.5/3	0.2 A 25	2041190000
ATPG 2.5/5	0.2 A 25	2041180000
Test plug		
PS 2.0 MC	20	0310000000
Screwdriver		
SDIL 0,6X3,5X100	1	2749140000
Marking tags		
DEK 5/5 PLUS MC NE WS	1000	1854490000
DEK 5/5 MM WS	800	2007110000
WS 8/5 MM WS	800	2007150000
WS 10/5 M PLUS MC NE WS	600	2003770000

Type	Qty.	Order No.
ZQV 2.5N/2	24 A 60	1527540000
ZQV 2.5N/10	24 A 20	1527690000
Vertical jumpers		
End plate		
SEP 3C 2.5	20	2751090000
End bracket		
AEB 35 SC/1	50	1991920000
AEB 35 SCL/1 V0	20	2661280000
Test adapter		
ATPG 1.5-10 L	0.2 A 50	1991890000
ATPG 2.5 MHR	0.2 A 50	1991960000
ATPG 2.5/3	0.2 A 25	2041190000
ATPG 2.5/5	0.2 A 25	2041180000
Test plug		
PS 2.0 MC	20	0310000000
Screwdriver		
SDIL 0,6X3,5X100	1	2749140000
Marking tags		
DEK 5/5 PLUS MC NE WS	1000	1854490000
DEK 5/5 MM WS	800	2007110000
WS 8/5 MM WS	800	2007150000
WS 10/5 M PLUS MC NE WS	600	2003770000

For detailed information on other accessories and application in the online catalogue

S4C 2.5

2.5 mm²

SNAP IN

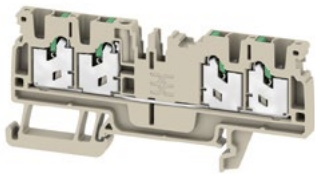

5.1 x 84 x 38
24 / 2.5
0.5...2.5

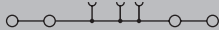

IEC 60947-7-1

IEC	UL	CSA	EN 60079-7
800	600	600	
24	15	15	
2.5	AWG 20...14	AWG 20...14	
8 kV / 3			
A2 / V-0			

CE

Rated connection

0.5...2.5 / 0.5...2.5
0.5...2.5 / 0.5...2.5
10 / 0.6 x 3.5 mm

Type	Qty.	Order No.
S4C 2.5	100	2674550000
S4C 2.5 BL	100	2753960000
S4C 2.5 OR	100	2875140000

Type	Qty.	Order No.
ZQV 2.5N/2	24 A 60	1527540000
ZQV 2.5N/10	24 A 20	1527690000
SEP 4C 2.5	20	2751100000
AEB 35 SC/1	50	1991920000
AEB 35 SCL/1 VO	20	2661280000
ATPG 1.5-10 L	0.2 A 50	1991890000
ATPG 2.5 MI-R	0.2 A 50	1991960000
ATPG 2.5/3	0.2 A 25	2041190000
ATPG 2.5/5	0.2 A 25	2041180000
PS 2.0 MC	20	0310000000
SDIL 0,6X3,5X100	1	2749140000
DEK 5/5 PLUS MC NE WS	1000	1854490000
DEK 5/5 MM WS	800	2007110000
WS 8/5 MM WS	800	2007150000
WS 10/5 M PLUS MC NE WS	600	2003770000

S2C 4

4 mm²

SNAP IN

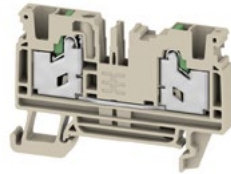

Q3
2023

6.1 x 62 x 41.5
32 / 4
0.5...4



IEC 60947-7-1

IEC	UL	CSA	EN 60079-7
800			
32			
4			
8 kV / 3			
A4 / V-0			

Rated connection

0.5...4 / 0.5...4
0.5...4 / 0.5...4
12 / 0.6 x 3.5 mm

Type	Qty.	Order No.
S2C 4	100	2874820000
S2C 4 BL	100	2874830000

Type	Qty.	Order No.
ZQV 4N/2	32 A 60	1527930000
ZQV 4N/10	32 A 20	1528090000
SEP 2C 4		2874790000
AEB 35 SC/1	50	1991920000
AEB 35 SCL/1 VO	20	2661280000
ATPG 1.5-10 L	0.2 A 50	1991890000
ATPG 4 MHR	0.2 A 50	1991860000
PS 2.0 MC	20	0310000000
SDIL 0,6X3,5X100	1	2749140000
WS 10/6 M PLUS MC NE WS	600	2003780000
DEK 5/6 MM WS	600	2007120000
WS 8/6 MM WS	600	2007160000
DEK 5/6 PLUS MC NE WS	1000	1011320000

S3C 4

4 mm²

SNAP IN

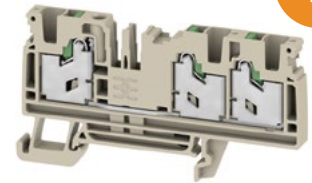

Q3
2023

6.1 x 78 x 41.5
32 / 4
0.5...4



IEC 60947-7-1

IEC	UL	CSA	EN 60079-7
800			
32			
4			
8 kV / 3			
A4 / V-0			

Rated connection

0.5...4 / 0.5...4
0.5...4 / 0.5...4
12 / 0.6 x 3.5 mm

Type	Qty.	Order No.
S3C 4	50	2874840000
S3C 4 BL	50	2874850000

Type	Qty.	Order No.
ZQV 4N/2	32 A 60	1527930000
ZQV 4N/10	32 A 20	1528090000
SEP 3C 4		2874800000
AEB 35 SC/1	50	1991920000
AEB 35 SCL/1 VO	20	2661280000
ATPG 1.5-10 L	0.2 A 50	1991890000
ATPG 4 MHR	0.2 A 50	1991860000
PS 2.0 MC	20	0310000000
SDIL 0,6X3,5X100	1	2749140000
WS 10/6 M PLUS MC NE WS	600	2003780000
DEK 5/6 MM WS	600	2007120000
WS 8/6 MM WS	600	2007160000
DEK 5/6 PLUS MC NE WS	1000	1011320000



Spring connection with SNAP IN technology (S-Series)
Feed-through terminal blocks



S4C 4

4 mm²

SNAP IN

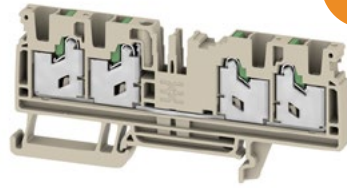

Q3 2023

S2T 2.5

2.5 mm²

SNAP IN

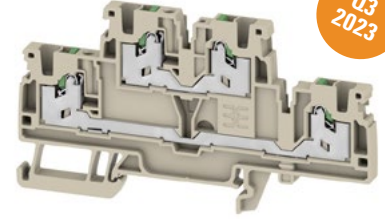

Q3 2023

Width/Height/Depth	mm
max. current / max. cond. cross-section	A/mm ²
Max. clamping range	mm ²

6.1 x 94 x 41.5	
32 / 4	
0.5...4	

5.1 x 90 x 50.5	
24 / 2.5	
0.5...2.5	

Technical data

Rated data	
Rated voltage	V
Rated current	A
for wire cross-section	mm ²
Rated impulse withstand voltage / Pollution severity	
Gauge to IEC 60947-1 / UL 94 flammability rating	
Approvals	
Clamped conductors (H05V/H07V)	
Solid / Stranded	mm ²
Flexible / Flexible with ferrule	mm ²
Stripping length / Blade size	mm/-
Note	

IEC 60947-7-1			
IEC	UL	CSA	EN 60079-7
800			
32			
4			
	8 kV / 3		
	A4 / V-0		
Rated connection			
0.5...4 / 0.5...4			
0.5...4 / 0.5...4			
12 / 0.6 x 3.5 mm			
Note			

IEC 60947-7-1			
IEC	UL	CSA	EN 60079-7
800			
24			
2.5			
	8 kV / 3		
	A2 / V-0		
Rated connection			
0.5...2.5 / 0.5...2.5			
0.5...2.5 / 0.5...2.5			
10 / 0.6 x 3.5 mm			
Note			

Ordering data

Version	
	dark beige
	Blue
	Orange
Note	

Type	Qty.	Order No.
S4C 4	50	2874860000
S4C 4 BL	50	2874870000
Note		

Type	Qty.	Order No.
S2T 2.5	50	2902380000
S2T 2.5 BL	50	2902390000
S2T 2.5 OR	50	2902400000
Note		

Accessories

Plug-in cross-connection	
	2-pole
	10-pole
	2-pole
	10-pole
Vertical jumpers	
	1-pole
End plate	
	dark beige
End bracket	
	dark beige, screwable
	dark beige, direct mounting
Test adapter	
	1-pole
	stackable
	3-pole
	5-pole
Test plug	
Screwdriver	
	Standard
Marking tags	

Type	Qty.	Order No.
ZQV 4N/2	32 A 60	1527930000
ZQV 4N/10	32 A 20	1528090000
Vertical jumpers		
SEP 4C 4		2874810000
AEB 35 SC/1	50	1991920000
AEB 35 SCL/1 V0	20	2661280000
Test adapter		
ATPG 1.5-10 L	0.2 A 50	1991890000
ATPG 4 MHR	0.2 A 50	1991860000
Test plug		
PS 2.0 MC	20	0310000000
Screwdriver		
SDIL 0,6X3,5X100	1	2749140000
Marking tags		
WS 10/6 M PLUS MC NE WS	600	2003780000
DEK 5/6 MM WS	600	2007120000
WS 8/6 MM WS	600	2007160000
DEK 5/6 PLUS MC NE WS	1000	1011320000
Note		

Type	Qty.	Order No.
ZQV 2.5N/2	24 A 60	1527540000
ZQV 2.5N/10	24 A 20	1527690000
Vertical jumpers		
ZVQ 2.5/1.5	24 A 50	1720700000
SEP 2T 2.5		2902630000
AEB 35 SC/1	50	1991920000
AEB 35 SCL/1 V0	20	2661280000
Test adapter		
ATPG 1.5-10 L	0.2 A 50	1991890000
ATPG 2.5 MHR	0.2 A 50	1991960000
ATPG 2.5/3	0.2 A 25	2041190000
ATPG 2.5/5	0.2 A 25	2041180000
Test plug		
PS 2.0 MC	20	0310000000
Screwdriver		
SDIL 0,6X3,5X100	1	2749140000
Marking tags		
DEK 5/5 PLUS MC NE WS	1000	1854490000
DEK 5/5 MM WS	800	2007110000
WS 8/5 MM WS	800	2007150000
WS 10/5 M PLUS MC NE WS	600	2003770000
SNAPMARK I	50	1805880000
Note		

For detailed information on other accessories and application in the online catalogue

S2T 2.5 VL

2.5 mm²

SNAP IN

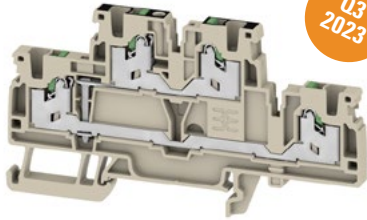

Q3
2023

5.1 x 90 x 50.5
24 / 2.5
0.5...2.5

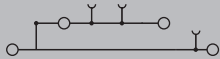

IEC 60947-7-1

IEC	UL	CSA	EN 60079-7
800			
24			
2.5			
8 kV / 3			
A2 / V-0			

Rated connection

0.5...2.5 / 0.5...2.5
0.5...2.5 / 0.5...2.5
10 / 0.6 x 3.5 mm

Type	Qty.	Order No.
S2T 2.5 VL	50	2902430000
S2T 2.5 VL BL	50	2902440000
S2T 2.5 VL OR	50	2902450000

Type	Qty.	Order No.
ZQV 2.5N/2	24 A 60	1527540000
ZQV 2.5N/10	24 A 20	1527690000
SEP 2T 2.5		2902630000
AEB 35 SC/1	50	1991920000
AEB 35 SCL/1 VO	20	2661280000
ATPG 1.5-10 L	0.2 A 50	1991890000
ATPG 2.5 MI-R	0.2 A 50	1991960000
ATPG 2.5/3	0.2 A 25	2041190000
ATPG 2.5/5	0.2 A 25	2041180000
PS 2.0 MC	20	0310000000
SDIL 0,6X3,5X100	1	2749140000
DEK 5/5 PLUS MC NE WS	1000	1854490000
DEK 5/5 MM WS	800	2007110000
WS 8/5 MM WS	800	2007150000
WS 10/5 M PLUS MC NE WS	600	2003770000
SNAPMARK I	50	1805880000

S2T 2.5 FT-PE

2.5 mm²

SNAP IN

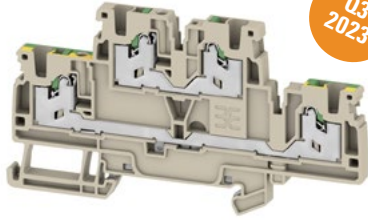

Q3
2023

5.1 x 90 x 50.5
24 / 2.5
0.5...2.5



IEC 60947-7-1

IEC	UL	CSA	EN 60079-7
800			
24			
2.5			
8 kV / 3			
A2 / V-0			

Rated connection

0.5...2.5 / 0.5...2.5
0.5...2.5 / 0.5...2.5
10 / 0.6 x 3.5 mm

Type	Qty.	Order No.
S2T 2.5 FT-PE	50	2902410000

Type	Qty.	Order No.
ZQV 2.5N/2	24 A 60	1527540000
ZQV 2.5N/10	24 A 20	1527690000
SEP 2T 2.5		2902630000
AEB 35 SC/1	50	1991920000
AEB 35 SCL/1 VO	20	2661280000
ATPG 1.5-10 L	0.2 A 50	1991890000
ATPG 2.5 MI-R	0.2 A 50	1991960000
ATPG 2.5/3	0.2 A 25	2041190000
ATPG 2.5/5	0.2 A 25	2041180000
PS 2.0 MC	20	0310000000
SDIL 0,6X3,5X100	1	2749140000
DEK 5/5 PLUS MC NE WS	1000	1854490000
DEK 5/5 MM WS	800	2007110000
WS 8/5 MM WS	800	2007150000
WS 10/5 M PLUS MC NE WS	600	2003770000
SNAPMARK I	50	1805880000

S2T 2.5 N-FT

2.5 mm²

SNAP IN

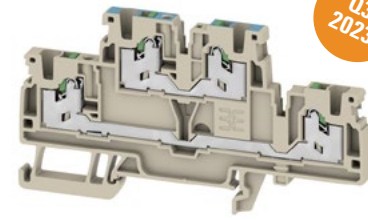

Q3
2023

5.1 x 90 x 50.5
24 / 2.5
0.5...2.5

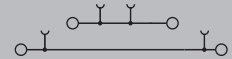

IEC 60947-7-1

IEC	UL	CSA	EN 60079-7
800			
24			
2.5			
8 kV / 3			
A2 / V-0			

Rated connection

0.5...2.5 / 0.5...2.5
0.5...2.5 / 0.5...2.5
10 / 0.6 x 3.5 mm

Type	Qty.	Order No.
S2T 2.5 N-FT	50	2902420000

Type	Qty.	Order No.
ZQV 2.5N/2	24 A 60	1527540000
ZQV 2.5N/10	24 A 20	1527690000
ZVQ 2.5/1.5	24 A 50	1720700000
SEP 2T 2.5		2902630000
AEB 35 SC/1	50	1991920000
AEB 35 SCL/1 VO	20	2661280000
ATPG 1.5-10 L	0.2 A 50	1991890000
ATPG 2.5 MI-R	0.2 A 50	1991960000
ATPG 2.5/3	0.2 A 25	2041190000
ATPG 2.5/5	0.2 A 25	2041180000
PS 2.0 MC	20	0310000000
SDIL 0,6X3,5X100	1	2749140000
DEK 5/5 PLUS MC NE WS	1000	1854490000
DEK 5/5 MM WS	800	2007110000
WS 8/5 MM WS	800	2007150000
WS 10/5 M PLUS MC NE WS	600	2003770000
SNAPMARK I	50	1805880000



Spring connection with SNAP IN technology (S-Series)

PE terminal blocks



S2C 2.5 PE

2.5 mm²

SNAP IN

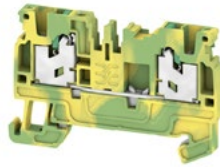

S3C 2.5 PE

2.5 mm²

SNAP IN

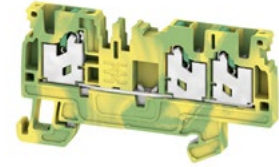

Width/Height/Depth	mm
max. current / max. cond. cross-section	-/mm ²
Max. clamping range	mm ²

5.1 x 59 x 38	
/ 2.5	
0.5...2.5	

5.1 x 71.5 x 38	
/ 2.5	
0.5...2.5	

Technical data

Rated data	
for wire cross-section	mm ²
Rated voltage to adjoining terminal	V/-
Rated impulse withstand voltage to adjacent terminal	-
Rated short-time current	
Pollution severity	
Gauge to IEC 60947-1 / UL 94 flammability rating	
Approvals	
Clamped conductors (H05V/H07V)	
Solid / Stranded	mm ²
Flexible / Flexible with ferrule	mm ²
Stripping length / Blade size	mm/-

IEC 60947-7-2			
IEC	UL	CSA	EN 60079-7
2.5		AWG 20...14	
800 /			
		300 A (2.5 mm ²)	
		3	
		A2 / V-0	
Rated connection			
0.5...2.5 / 0.5...2.5			
0.5...2.5 / 0.5...2.5			
10 / 0.6 x 3.5 mm			

IEC 60947-7-2			
IEC	UL	CSA	EN 60079-7
2.5		AWG 20...14	
800 /			
		300 A (2.5 mm ²)	
		3	
		A2 / V-0	
Rated connection			
0.5...2.5 / 0.5...2.5			
0.5...2.5 / 0.5...2.5			
10 / 0.6 x 3.5 mm			

Note

Ordering data

Version	
	Green/yellow
Note	

Type	Qty.	Order No.
S2C 2.5 PE	50	2674560000

Type	Qty.	Order No.
S3C 2.5 PE	50	2674570000

Accessories

End plate	dark beige
End bracket	dark beige, screwable dark beige, direct mounting
Test adapter	1-pole stackable 3-pole 5-pole
Test plug	
Screwdriver	Standard
Marking tags	

Type	Qty.	Order No.
SEP 2C 2.5	20	2751080000
AEB 35 SC/1	50	1991920000
AEB 35 SCL/1 V0	20	2661280000
ATPG 1.5-10 L	0.2 A 50	1991890000
ATPG 2.5 MHR	0.2 A 50	1991960000
ATPG 2.5/3	0.2 A 25	2041190000
ATPG 2.5/5	0.2 A 25	2041180000
PS 2.0 MC	20	0310000000
SDIL 0,6X3,5X100	1	2749140000
DEK 5/5 PLUS MC NE WS	1000	1854490000
DEK 5/5 MM WS	800	2007110000
WS 8/5 MM WS	800	2007150000
WS 10/5 M PLUS MC NE WS	600	2003770000

Type	Qty.	Order No.
SEP 3C 2.5	20	2751090000
AEB 35 SC/1	50	1991920000
AEB 35 SCL/1 V0	20	2661280000
ATPG 1.5-10 L	0.2 A 50	1991890000
ATPG 2.5 MHR	0.2 A 50	1991960000
ATPG 2.5/3	0.2 A 25	2041190000
ATPG 2.5/5	0.2 A 25	2041180000
PS 2.0 MC	20	0310000000
SDIL 0,6X3,5X100	1	2749140000
DEK 5/5 PLUS MC NE WS	1000	1854490000
DEK 5/5 MM WS	800	2007110000
WS 8/5 MM WS	800	2007150000
WS 10/5 M PLUS MC NE WS	600	2003770000

For detailed information on other accessories and application in the online catalogue

S4C 2.5 PE

2.5 mm²

SNAP IN

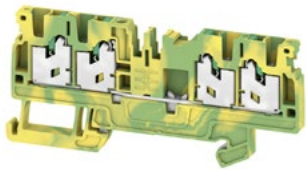

5.1 x 84 x 38
/ 2.5
0.5...2.5



IEC 60947-7-2

IEC	UL	CSA	EN 60079-7
2.5		AWG 20...14	
800 /			
	300 A (2.5 mm ²)		
	3		
	A2 / V-0		

CE

Rated connection

0.5...2.5 / 0.5...2.5
0.5...2.5 / 0.5...2.5
10 / 0.6 x 3.5 mm

Type	Qty.	Order No.
S4C 2.5 PE	50	2674580000

Type	Qty.	Order No.	
SEP 4C 2.5	20	2751100000	
AEB 35 SC/1	50	1991920000	
AEB 35 SCL/1 V0	20	2661280000	
ATPG 1.5-10 L	0.2 A	50	1991890000
ATPG 2.5 MI-R	0.2 A	50	1991960000
ATPG 2.5/3	0.2 A	25	2041190000
ATPG 2.5/5	0.2 A	25	2041180000
PS 2.0 MC	20	0310000000	
SDIL 0,6X3,5X100	1	2749140000	
DEK 5/5 PLUS MC NE WS	1000	1854490000	
DEK 5/5 MM WS	800	2007110000	
WS 8/5 MM WS	800	2007150000	
WS 10/5 M PLUS MC NE WS	600	2003770000	

S2C 4 PE

4 mm²

SNAP IN

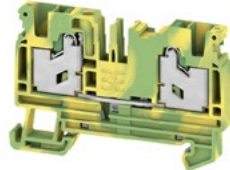

Q3
2023

6.1 x 62 x 41.5
/ 4
0.5...4



IEC 60947-7-2

IEC	UL	CSA	EN 60079-7
4			
800 /			
	480 A (4 mm ²)		
	3		
	A4 / V-0		

Rated connection

0.5...4 / 0.5...4
0.5...4 / 0.5...4
12 / 0.6 x 3.5 mm

Type	Qty.	Order No.
S2C 4 PE	50	2874880000

Type	Qty.	Order No.	
SEP 2C 4		2874790000	
AEB 35 SC/1	50	1991920000	
AEB 35 SCL/1 V0	20	2661280000	
ATPG 1.5-10 L	0.2 A	50	1991890000
ATPG 4 MI-R	0.2 A	50	1991860000
PS 2.0 MC	20	0310000000	
SDIL 0,6X3,5X100	1	2749140000	
WS 10/6 M PLUS MC NE WS	600	2003780000	
DEK 5/6 MM WS	600	2007120000	
WS 8/6 MM WS	600	2007160000	
DEK 5/6 PLUS MC NE WS	1000	1011320000	

S3C 4 PE

4 mm²

SNAP IN

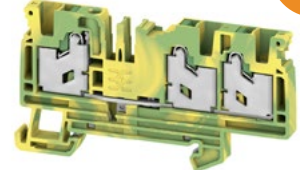

Q3
2023

6.1 x 78 x 41.5
/ 4
0.5...4

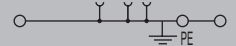

IEC 60947-7-2

IEC	UL	CSA	EN 60079-7
4			
800 /			
	480 A (4 mm ²)		
	3		
	A4 / V-0		

Rated connection

0.5...4 / 0.5...4
0.5...4 / 0.5...4
12 / 0.6 x 3.5 mm

Type	Qty.	Order No.
S3C 4 PE	50	2874890000

Type	Qty.	Order No.	
SEP 3C 4		2874800000	
AEB 35 SC/1	50	1991920000	
AEB 35 SCL/1 V0	20	2661280000	
ATPG 1.5-10 L	0.2 A	50	1991890000
ATPG 2.5 MI-R	0.2 A	50	1991960000
PS 2.0 MC	20	0310000000	
SDIL 0,6X3,5X100	1	2749140000	
DEK 5/5 PLUS MC NE WS	1000	1854490000	
DEK 5/5 MM WS	800	2007110000	
WS 8/5 MM WS	800	2007150000	
WS 10/5 M PLUS MC NE WS	600	2003770000	



Spring connection with SNAP IN technology (S-Series)

PE terminal blocks

Universal range

A



S4C 4 PE

4 mm²

SNAP IN

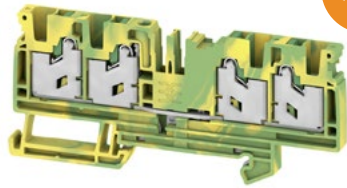

Q3 2023

S2T 2.5 PE

2.5 mm²

SNAP IN

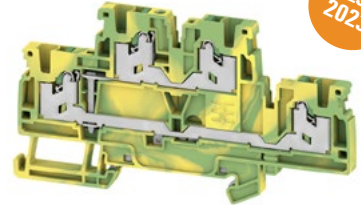

Q3 2023

Width/Height/Depth	mm
max. current / max. cond. cross-section	-/mm ²
Max. clamping range	mm ²

6.1 x 94 x 41.5	
/ 4	
0.5...4	

5.1 x 90 x 50.5	
/ 2.5	
0.5...2.5	

Technical data

Rated data	
for wire cross-section	mm ²
Rated voltage to adjoining terminal	V/-
Rated impulse withstand voltage to adjacent terminal	-
Rated short-time current	
Pollution severity	
Gauge to IEC 60947-1 / UL 94 flammability rating	
Approvals	
Clamped conductors (H05V/H07V)	
Solid / Stranded	mm ²
Flexible / Flexible with ferrule	mm ²
Stripping length / Blade size	mm/-

IEC 60947-7-2			
IEC	UL	CSA	EN 60079-7
4			
800 /			
	480 A (4 mm ²)		
	3		
	A4 / V-0		

IEC 60947-7-2			
IEC	UL	CSA	EN 60079-7
2.5			
800 /			
	300 A (2.5 mm ²)		
	3		
	A2 / V-0		

Rated connection	
0.5...4 / 0.5...4	
0.5...4 / 0.5...4	
12 / 0.6 x 3.5 mm	

Rated connection	
0.5...2.5 / 0.5...2.5	
0.5...2.5 / 0.5...2.5	
10 / 0.6 x 3.5 mm	

Note

Ordering data

Version	Green/yellow
Note	

Type	Qty.	Order No.
S4C 4 PE	50	2874900000

Type	Qty.	Order No.
S2T 2.5 PE	50	2902460000

Accessories

End plate	dark beige
End bracket	dark beige, screwable dark beige, direct mounting
Test adapter	1-pole stackable 3-pole 5-pole
Test plug	
Screwdriver	Standard
Marking tags	

Type	Qty.	Order No.
SEP 4C 4		2874810000
AEB 35 SC/1	50	1991920000
AEB 35 SCL/1 V0	20	2661280000
ATPG 1.5-10 L	0.2 A 50	1991890000
ATPG 4 MHR	0.2 A 50	1991860000
PS 2.0 MC	20	0310000000
SDIL 0,6X3,5X100	1	2749140000
WS 10/6 M PLUS MC NE WS	600	2003780000
DEK 5/6 MM WS	600	2007120000
WS 8/6 MM WS	600	2007160000
DEK 5/6 PLUS MC NE WS	1000	1011320000

Type	Qty.	Order No.
SEP 2T 2.5		2902630000
AEB 35 SC/1	50	1991920000
AEB 35 SCL/1 V0	20	2661280000
ATPG 1.5-10 L	0.2 A 50	1991890000
ATPG 2.5 MHR	0.2 A 50	1991960000
PS 2.0 MC	20	0310000000
SDIL 0,6X3,5X100	1	2749140000
DEK 5/5 PLUS MC NE WS	1000	1854490000
DEK 5/5 MM WS	800	2007110000
WS 8/5 MM WS	800	2007150000
WS 10/5 M PLUS MC NE WS	600	2003770000
SNAPMARK I	50	1805880000

For detailed information on other accessories and application in the online catalogue



Fast wiring. But safe.

Klippon® Connect enhances your efficiency with PUSH IN technology

Increase your efficiency during installations without compromising on safety. The innovative PUSH IN technology reduces connection times for solid conductors and conductors with crimped-on wire-end ferrules by up to 50 percent compared to tension clamp terminals. The conductor is simply inserted into the contact point as far as the stop and that's it – you have a safe, gas-tight connection. Even stranded-wire conductors can be connected without any problem and without the need for special tools.



Safe and reliable connections are crucial, especially under harsh conditions, such as those encountered in the process industry. PUSH IN technology guarantees optimal contact security and ease of handling, even in demanding applications.

Our promise

Klippon® Connect gives your panel design maximum flexibility thanks to PUSH IN technology. The extremely compact design and simple handling at the same time help to make processes more efficient right from the planning stage.

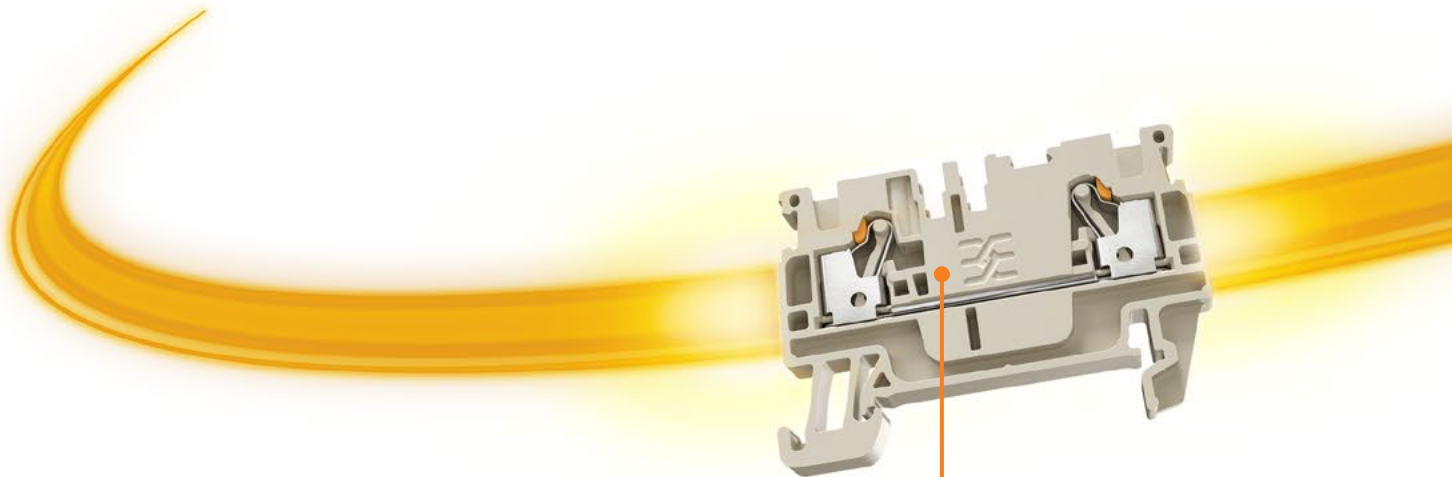

Safety

- Standardised test point
- Optical and physical separation of operation and conductor entry
- Vibration-resistant, gas-tight connection with copper power rails and stainless steel spring



Flexibility

- Release the conductor with any tool
- Large marking surfaces make maintenance work easier
- Clip-in foot compensates for differences in terminal rail dimensions

Time saving

- Mounting foot makes unlatching the terminal block easy
- Clear distinction made between all functional areas
- Easier marking and wiring

Space-saving design

- Slim design creates a large amount of space in the panel
- High wiring density despite less space being required on the terminal rail

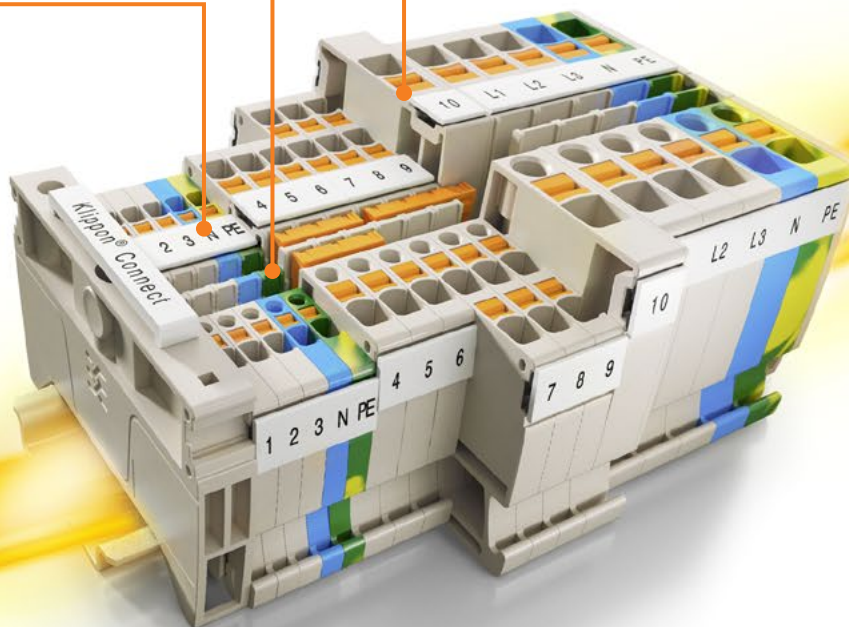

Overview

Thanks to the extensive choice of accessories and the different cross-connection options, our PUSH IN terminal blocks are the perfect solution for every requirement.

Functional transparency:

All of the terminal blocks' functions can be clearly differentiated from one another – thus ensuring safe and efficient maintenance work.

Ready for automation:

A clear design and simple handling provide the perfect prerequisites for the automation of your panel design.

Safely prevent incorrect wiring:

The pusher for releasing the contacts ensures safe contact protection.



Spring connection with PUSH IN technology (A-Series)
Feed-through terminal blocks

Universal range

A

A2C 1.5

1.5 mm²

A3C 1.5

1.5 mm²

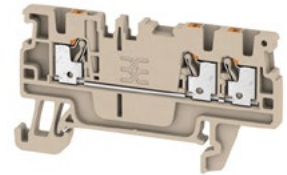
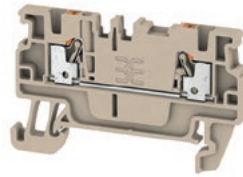

Width/Height/Depth	mm
max. current / max. cond. cross-section	A/mm ²
Max. clamping range	mm ²

3.5 x 55 x 33.5	
17.5 / 1.5	
0.14...1.5	

3.5 x 61.5 x 33.5	
17.5 / 1.5	
0.14...1.5	

Technical data

Rated data	
Rated voltage	V
Rated current	A
for wire cross-section	mm ²
Rated impulse withstand voltage / Pollution severity	
Gauge to IEC 60947-1 / UL 94 flammability rating	
Approvals	
Clamped conductors (H05V/H07V)	
Solid / Stranded	mm ²
Flexible / Flexible with ferrule	mm ²
Stripping length / Blade size	mm/-
Note	

IEC 60947-7-1			
Ex eb II C Gb II 2 G D			
IEC	UL	CSA	EN 60079-7
500	300	300	550
17.5	13	13	15
1.5	AWG 26...14	AWG 26...14	1.5 mm ²
6 kV / 3			
A1 / V-0			
TUEV16ATEX7909U			
Rated connection			
0.5...1.5 / 0.5...1.5			
0.5...1.5 / 0.5...1			
8 / 0.4 x 2.0 mm			
Note			

IEC 60947-7-1			
Ex eb II C Gb II 2 G D			
IEC	UL	CSA	EN 60079-7
500	300	300	440
17.5	13	13	15
1.5	AWG 26...14	AWG 26...14	1.5 mm ²
6 kV / 3			
A1 / V-0			
TUEV16ATEX7909U			
Rated connection			
0.5...1.5 / 0.5...1.5			
0.5...1.5 / 0.5...1			
8 / 0.4 x 2.0 mm			
Note			

Ordering data

Version	
	dark beige
	Blue
Note	

Type	Qty.	Order No.
A2C 1.5	100	1552790000
A2C 1.5 BL	100	1552820000
Note		

Type	Qty.	Order No.
A3C 1.5	50	1552740000
A3C 1.5 BL	50	1552770000
Note		

Accessories

Plug-in cross-connection	
	2-pole
	10-pole
	2-pole
	10-pole
	2-pole
	10-pole
End plate	
	dark beige
	Blue
End bracket	
	dark beige, screwable
	dark beige, direct mounting
Test adapter	
	1-pole
	stackable
	3-pole
	5-pole
Test plug	
Screwdriver	
	Standard
Marking tags	

Type	Qty.	Order No.
ZQV 1.5N/2	17.5 A 60	1985410000
ZQV 1.5N/10	17.5 A 20	1985580000
Note		
AEP 2C 1.5	50	1552600000
AEP 2C 1.5 BL	50	1552610000
Note		
AEB 35 SC/1	50	1991920000
AEB 35 SCL/1 V0	20	2661280000
Note		
ATPG 1.5-10 L	0.2 A 50	1991890000
ATPG 1.5 MHR	0.2 A 50	1991880000
Note		
PS 2.0 MC	20	0310000000
Note		
SDS 0.4X2.0X60	1	2749260000
Note		
WS 8/3.5 MM WS	1000	2007140000
DEK 5/3.5 MM WS	1000	2007100000
Note		
DEK 5/3.5 PLUS MC NE WS	1600	2003750000

Type	Qty.	Order No.
ZQV 1.5N/2	17.5 A 60	1985410000
ZQV 1.5N/10	17.5 A 20	1985580000
Note		
AEP 3C 1.5	50	1552620000
AEP 3C 1.5 BL	50	1552630000
Note		
AEB 35 SC/1	50	1991920000
AEB 35 SCL/1 V0	20	2661280000
Note		
ATPG 1.5-10 L	0.2 A 50	1991890000
ATPG 1.5 MHR	0.2 A 50	1991880000
Note		
PS 2.0 MC	20	0310000000
Note		
SDS 0.4X2.0X60	1	2749260000
Note		
WS 8/3.5 MM WS	1000	2007140000
DEK 5/3.5 MM WS	1000	2007100000
Note		
DEK 5/3.5 PLUS MC NE WS	1600	2003750000

For detailed information on other accessories and application in the online catalogue

A4C 1.5

1.5 mm²

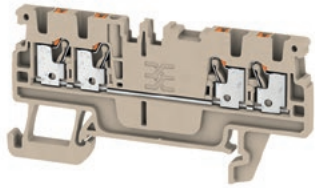

3.5 x 67.5 x 33.5
17.5 / 1.5
0.14...1.5

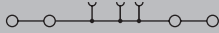

IEC 60947-7-1 Ex eb II C Gb II 2 G D

IEC	UL	CSA	EN 60079-7
500	300	300	440
17.5	13	13	15
1.5	AWG 26...14	AWG 26...14	1.5 mm ²

6 kV / 3
A1 / V-0

TUEV16ATEX7909U

Rated connection

0.5...1.5 / 0.5...1.5
0.5...1.5 / 0.5...1
8 / 0.4 x 2.0 mm

A2C 2.5

2.5 mm²

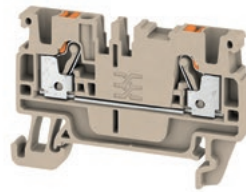

5.1 x 55 x 36.5
24 / 4
0.14...4



IEC 60947-7-1 Ex eb II C Gb II 2 G D

IEC	UL	CSA	EN 60079-7
800	600	600	550
24	20	20	20
2.5	AWG 28...12	AWG 28...12	2.5 mm ²

8 kV / 3
A3 / V-0

TUEV16ATEX7909U

Rated connection

0.5...2.5 / 0.5...4
0.5...4 / 0.5...2.5
10 / 0.6 x 3.5 mm

AL2C 2.5

2.5 mm²

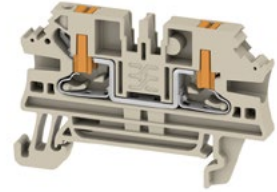

5.1 x 57 x 36.5
24 / 2.5
0.14...2.5



IEC 60947-7-1

IEC	UL	CSA	EN 60079-7
800			
24			
2.5			

8 kV / 3
A3 / V-0

CE

Rated connection

0.5...2.5 / 0.5...2.5
0.5...2.5 / 0.5...2.5
10 / 0.6 x 3.5 mm

Type	Qty.	Order No.
A4C 1.5	100	1552690000
A4C 1.5 BL	100	1552700000

Type	Qty.	Order No.
A2C 2.5	100	1521850000
A2C 2.5 BL	100	1521880000

Type	Qty.	Order No.
AL2C 2.5	50	2847200000
AL2C 2.5 BL	50	2847210000

Type	Qty.	Order No.
ZQV 1.5N/2	17.5 A 60	1985410000
ZQV 1.5N/10	17.5 A 20	1985580000
AEP 4C 1.5	50	1552640000
AEP 4C 1.5 BL	50	1552650000
AEB 35 SC/1	50	1991920000
AEB 35 SCL/1 VO	20	2661280000
ATPG 1.5-10 L	0.2 A 50	1991890000
ATPG 1.5 MI-R	0.2 A 50	1991880000
PS 2.0 MC	20	0310000000
SDS 0.4X2.0X60	1	2749260000
WS 8/3.5 MM WS	1000	2007140000
DEK 5/3.5 MM WS	1000	2007100000
DEK 5/3.5 PLUS MC NE WS	1600	2003750000

Type	Qty.	Order No.
ZQV 2.5N/2	24 A 60	1527540000
ZQV 2.5N/10	24 A 20	1527690000
AEP 2C 2.5	50	1514400000
AEP 2C 2.5 BL	50	1514420000
AEB 35 SC/1	50	1991920000
AEB 35 SCL/1 VO	20	2661280000
ATPG 1.5-10 L	0.2 A 50	1991890000
ATPG 2.5 MI-R	0.2 A 50	1991960000
ATPG 2.5/3	0.2 A 25	2041190000
ATPG 2.5/5	0.2 A 25	2041180000
PS 2.0 MC	20	0310000000
SDIL 0.6X3.5X100	1	2749140000
DEK 5/5 PLUS MC NE WS	1000	1854490000
DEK 5/5 MM WS	800	2007110000
WS 8/5 MM WS	800	2007150000
WS 10/5 M PLUS MC NE WS	600	2003770000

Type	Qty.	Order No.
ZQV 2.5N/2	24 A 60	1527540000
ZQV 2.5N/10	24 A 20	1527690000
ALEP 2C 2.5	20	2871750000
ALEP 2C 2.5 BL	20	2871760000
AEB 35 SC/1	50	1991920000
AEB 35 SCL/1 VO	20	2661280000
ATPG 1.5-10 L	0.2 A 50	1991890000
ATPG 2.5 MI-R	0.2 A 50	1991960000
ATPG 2.5/3	0.2 A 25	2041190000
ATPG 2.5/5	0.2 A 25	2041180000
PS 2.0 MC	20	0310000000
SDIL 0.6X3.5X100	1	2749140000
DEK 5/5 PLUS MC NE WS	1000	1854490000
DEK 5/5 MM WS	800	2007110000
WS 8/5 MM WS	800	2007150000
WS 10/5 M PLUS MC NE WS	600	2003770000



Spring connection with PUSH IN technology (A-Series)

Feed-through terminal blocks

Universal range

A

A3C 2.5

2.5 mm²

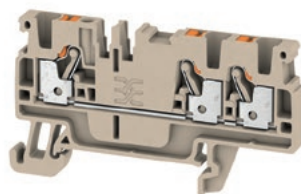

AL3C 2.5

2.5 mm²

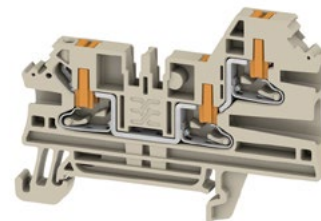

Width/Height/Depth	mm
max. current / max. cond. cross-section	A/mm ²
Max. clamping range	mm ²

5.1 x 66.5 x 36.5	
24 / 4	
0.14...4	

5.1 x 68 x 48	
24 / 2.5	
0.14...2.5	

Technical data

Rated data	
Rated voltage	V
Rated current	A
for wire cross-section	mm ²
Rated impulse withstand voltage / Pollution severity	
Gauge to IEC 60947-1 / UL 94 flammability rating	
Approvals	
Clamped conductors (H05V/H07V)	
Solid / Stranded	mm ²
Flexible / Flexible with ferrule	mm ²
Stripping length / Blade size	mm/-
Note	

IEC 60947-7-1

Ex eb II C Gb II 2 G D			
IEC	UL	CSA	EN 60079-7
800	600	600	550
24	20	20	21
2.5	AWG 28...12	AWG 28...12	2.5 mm ²
8 kV / 3			
A3 / V-0			
TUEV16ATEX7909U			
Rated connection			
0.5...2.5 / 0.5...4			
0.5...4 / 0.5...2.5			
10 / 0.6 x 3.5 mm			

IEC 60947-7-1

IEC	UL	CSA	EN 60079-7
800			
24			
2.5			
8 kV / 3			
A3 / V-0			
Rated connection			
0.5...2.5 / 0.5...2.5			
0.5...2.5 / 0.5...2.5			
10 / 0.6 x 3.5 mm			

Ordering data

Version	
	dark beige
	Blue
Note	

Type	Qty.	Order No.
A3C 2.5	100	1521740000
A3C 2.5 BL	100	1521780000

Type	Qty.	Order No.
AL3C 2.5	50	2847330000
AL3C 2.5 BL	50	2847340000

Accessories

Plug-in cross-connection	
	2-pole
	10-pole
	2-pole
	10-pole
	2-pole
	10-pole
End plate	
	dark beige
	Blue
End bracket	
	dark beige, screwable
	dark beige, direct mounting
Test adapter	
	1-pole
	stackable
	3-pole
	5-pole
Test plug	
Screwdriver	
	Standard
Marking tags	

Type	Qty.	Order No.
ZQV 2.5N/2	24 A 60	1527540000
ZQV 2.5N/10	24 A 20	1527690000
End plate		
AEP 3C 2.5	50	1521510000
AEP 3C 2.5 BL	50	1521520000
End bracket		
AEB 35 SC/1	50	1991920000
AEB 35 SCL/1 V0	20	2661280000
Test adapter		
ATPG 1.5-10 L	0.2 A 50	1991890000
ATPG 2.5 MHR	0.2 A 50	1991960000
ATPG 2.5/3	0.2 A 25	2041190000
ATPG 2.5/5	0.2 A 25	2041180000
Test plug		
PS 2.0 MC	20	0310000000
Screwdriver		
SDIL 0,6X3,5X100	1	2749140000
Marking tags		
DEK 5/5 PLUS MC NE WS	1000	1854490000
DEK 5/5 MM WS	800	2007110000
WS 8/5 MM WS	800	2007150000
WS 10/5 M PLUS MC NE WS	600	2003770000

Type	Qty.	Order No.
ZQV 2.5N/2	24 A 60	1527540000
ZQV 2.5N/10	24 A 20	1527690000
End plate		
ALEP 3C 2.5	20	2871770000
ALEP 3C 2.5 BL	20	2871780000
End bracket		
AEB 35 SC/1	50	1991920000
AEB 35 SCL/1 V0	20	2661280000
Test adapter		
ATPG 1.5-10 L	0.2 A 50	1991890000
ATPG 2.5 MHR	0.2 A 50	1991960000
ATPG 2.5/3	0.2 A 25	2041190000
ATPG 2.5/5	0.2 A 25	2041180000
Test plug		
PS 2.0 MC	20	0310000000
Screwdriver		
SDIL 0,6X3,5X100	1	2749140000
Marking tags		
DEK 5/5 PLUS MC NE WS	1000	1854490000
DEK 5/5 MM WS	800	2007110000
WS 8/5 MM WS	800	2007150000
WS 10/5 M PLUS MC NE WS	600	2003770000

For detailed information on other accessories and application in the online catalogue

A4C 2.5

2.5 mm²

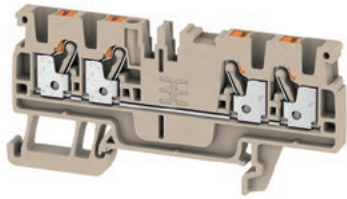

5.1 x 77.5 x 36.5
24 / 4
0.14...4

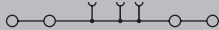

IEC 60947-7-1 Ex eb II C Gb II 2 G D

IEC	UL	CSA	EN 60079-7
800	600	600	550
24	20	20	21
2.5	AWG 28...12	AWG 28...12	2.5 mm ²

8 kV / 3
A3 / V-0

TUEV16ATEX7909U

Rated connection

0.5...2.5 / 0.5...4
0.5...4 / 0.5...2.5
10 / 0.6 x 3.5 mm

AL4C 2.5

2.5 mm²

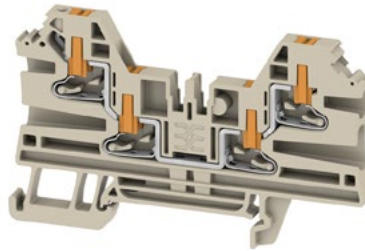

5.1 x 79.5 x 48
24 / 2.5
0.14...2.5



IEC 60947-7-1

IEC	UL	CSA	EN 60079-7
800			
24			
2.5			

8 kV / 3
A3 / V-0

TUEV16ATEX7909U

Rated connection

0.5...2.5 / 0.5...2.5
0.5...2.5 / 0.5...2.5
10 / 0.6 x 3.5 mm

A2C 4

4 mm²

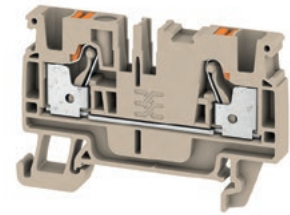

6.1 x 60 x 39.5
32 / 6
0.14...6



IEC 60947-7-1 Ex eb II C Gb II 2 G D

IEC	UL	CSA	EN 60079-7
800	600	600	550
32	30	30	28
4	AWG 28...10	AWG 26...10	4 mm ²

8 kV / 3
A4 / V-0

TUEV16ATEX7909U

Rated connection

0.5...4 / 0.5...6
0.5...6 / 0.5...4
12 / 0.6 x 3.5 mm

Type	Qty.	Order No.
A4C 2.5	100	1521690000
A4C 2.5 BL	100	1521700000

Type	Qty.	Order No.
AL4C 2.5	50	2847460000
AL4C 2.5 BL	50	2847470000

Type	Qty.	Order No.
A2C 4	100	2051180000
A2C 4 BL	100	2051210000

Type	Qty.	Order No.
ZQV 2.5N/2	24 A 60	1527540000
ZQV 2.5N/10	24 A 20	1527690000

Type	Qty.	Order No.
ZQV 2.5N/2	24 A 60	1527540000
ZQV 2.5N/10	24 A 20	1527690000

Type	Qty.	Order No.
ZQV 4N/2	32 A 60	1527930000
ZQV 4N/10	32 A 20	1528090000

AEP 4C 2.5	50	1521530000
AEP 4C 2.5 BL	50	1521640000
AEB 35 SC/1	50	1991920000
AEB 35 SCL/1 VO	20	2661280000

ALEP 4C 2.5	20	2871790000
ALEP 4C 2.5 BL	20	2871800000
AEB 35 SC/1	50	1991920000
AEB 35 SCL/1 VO	20	2661280000

AEP 2C 4	50	2051680000
AEP 2C 4 BL	50	2051690000
AEB 35 SC/1	50	1991920000
AEB 35 SCL/1 VO	20	2661280000

ATPG 1.5-10 L	0.2 A 50	1991890000
ATPG 2.5 MI-R	0.2 A 50	1991960000
ATPG 2.5/3	0.2 A 25	2041190000
ATPG 2.5/5	0.2 A 25	2041180000

ATPG 1.5-10 L	0.2 A 50	1991890000
ATPG 2.5 MI-R	0.2 A 50	1991960000
ATPG 2.5/3	0.2 A 25	2041190000
ATPG 2.5/5	0.2 A 25	2041180000

ATPG 1.5-10 L	0.2 A 50	1991890000
ATPG 4 MI-R	0.2 A 50	1991860000

PS 2.0 MC	20	0310000000
-----------	----	------------

PS 2.0 MC	20	0310000000
-----------	----	------------

PS 2.0 MC	20	0310000000
-----------	----	------------

SDIL 0,6X3,5X100	1	2749140000
------------------	---	------------

SDIL 0,6X3,5X100	1	2749140000
------------------	---	------------

SDIL 0,6X3,5X100	1	2749140000
------------------	---	------------

DEK 5/5 PLUS MC NE WS	1000	1854490000
DEK 5/5 MM WS	800	2007110000
WS 8/5 MM WS	800	2007150000
WS 10/5 M PLUS MC NE WS	600	2003770000

DEK 5/5 PLUS MC NE WS	1000	1854490000
DEK 5/5 MM WS	800	2007110000
WS 8/5 MM WS	800	2007150000
WS 10/5 M PLUS MC NE WS	600	2003770000

WS 10/6 M PLUS MC NE WS	600	2003780000
DEK 5/6 MM WS	600	2007120000
WS 8/6 MM WS	600	2007160000
DEK 5/6 PLUS MC NE WS	1000	1011320000



Spring connection with PUSH IN technology (A-Series)
Feed-through terminal blocks

AL2C 4

4 mm²

A3C 4

4 mm²

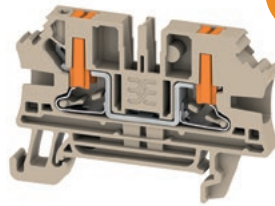

Q3
2023

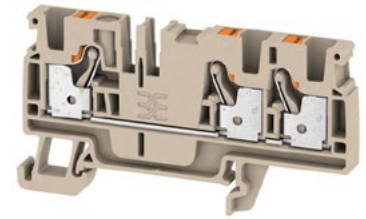

Width/Height/Depth	mm
max. current / max. cond. cross-section	A/mm ²
Max. clamping range	mm ²

6.1 x 60 x 39.5	
32 / 4	
0.14...4	

6.1 x 74 x 39.5	
32 / 6	
0.14...6	

Technical data

Rated data	
Rated voltage	V
Rated current	A
for wire cross-section	mm ²
Rated impulse withstand voltage / Pollution severity	
Gauge to IEC 60947-1 / UL 94 flammability rating	
Approvals	
Clamped conductors (H05V/H07V)	
Solid / Stranded	mm ²
Flexible / Flexible with ferrule	mm ²
Stripping length / Blade size	mm/-
Note	

IEC 60947-7-1			
IEC	UL	CSA	EN 60079-7
1000			
32			
4			
	8 kV / 3		
	A4 / V-0		
Rated connection			
0.5...4 / 0.5...4			
0.5...4 / 0.5...4			
12 / 0.6 x 3.5 mm			
Note			

IEC 60947-7-1				Ex eb II C Gb II 2 G D	
IEC	UL	CSA	EN 60079-7		
800	600	600	550		
32	30	30	29		
4	AWG 28...10	AWG 26...10	4 mm ²		
8 kV / 3					
A4 / V-0					
TUEV16ATEX7909U					
Rated connection					
0.5...4 / 0.5...6					
0.5...6 / 0.5...4					
12 / 0.6 x 3.5 mm					
Note					

Ordering data

Version	
	dark beige
	Blue
Note	

Type	Qty.	Order No.
AL2C 4	50	2847710000
AL2C 4 BL	50	2871870000
Note		

Type	Qty.	Order No.
A3C 4	50	2051240000
A3C 4 BL	50	2051280000
Note		

Accessories

Plug-in cross-connection	
	2-pole
	10-pole
	2-pole
	10-pole
	2-pole
	10-pole
End plate	
	dark beige
	Blue
End bracket	
	dark beige, screwable
	dark beige, direct mounting
Test adapter	
	1-pole
	stackable
	3-pole
	5-pole
Test plug	
Screwdriver	
	Standard
Marking tags	

Type	Qty.	Order No.
ZQV 4N/2	32 A 60	1527930000
ZQV 4N/10	32 A 20	1528090000
ALEP 2C 4		2871810000
ALEP 2C 4 BL		2871820000
AEB 35 SC/1	50	1991920000
AEB 35 SCL/1 VO	20	2661280000
ATPG 1.5-10 L	0.2 A 50	1991890000
ATPG 4 MHR	0.2 A 50	1991860000
PS 2.0 MC	20	0310000000
SDIL 0,6X3,5X100	1	2749140000
WS 10/6 M PLUS MC NE WS	600	2003780000
DEK 5/6 MM WS	600	2007120000
WS 8/6 MM WS	600	2007160000
DEK 5/6 PLUS MC NE WS	1000	1011320000
Note		

Type	Qty.	Order No.
ZQV 4N/2	32 A 60	1527930000
ZQV 4N/10	32 A 20	1528090000
AEP 3C 4	20	2051720000
AEP 3C 4 BL	20	2051880000
AEB 35 SC/1	50	1991920000
AEB 35 SCL/1 VO	20	2661280000
ATPG 1.5-10 L	0.2 A 50	1991890000
ATPG 4 MHR	0.2 A 50	1991860000
PS 2.0 MC	20	0310000000
SDIL 0,6X3,5X100	1	2749140000
WS 10/6 M PLUS MC NE WS	600	2003780000
DEK 5/6 MM WS	600	2007120000
WS 8/6 MM WS	600	2007160000
DEK 5/6 PLUS MC NE WS	1000	1011320000
Note		

For detailed information on other accessories and application in the online catalogue

Spring connection with PUSH IN technology (A-Series)
Feed-through terminal blocks

Universal range

A

A2C 6

6 mm²

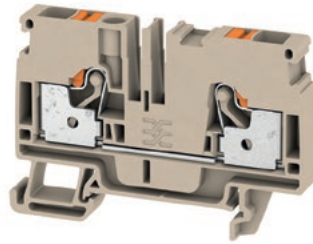

A3C 6

6 mm²

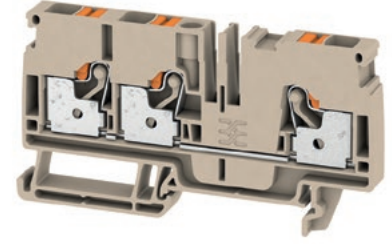

Width/Height/Depth	mm
max. current / max. cond. cross-section	A/mm ²
Max. clamping range	mm ²

8.1 x 66.5 x 45.5
41 / 10
0.34...10

8.1 x 84.5 x 45.5
41 / 10
0.34...10

Technical data

Rated data	
Rated voltage	V
Rated current	A
for wire cross-section	mm ²
Rated impulse withstand voltage / Pollution severity	
Gauge to IEC 60947-1 / UL 94 flammability rating	
Approvals	
Clamped conductors (H05V/H07V)	
Solid / Stranded	mm ²
Flexible / Flexible with ferrule	mm ²
Stripping length / Blade size	mm/-
Note	

IEC 60947-7-1 Ex eb II C Gb II 2 G D

IEC	UL	CSA	EN 60079-7
800	600	600	550
41	38	38	37
6	AWG 22...8	AWG 22...8	6 mm ²

8 kV / 3
A5 / V-0

TUEV16ATEX7909U

Rated connection
0.5...6 / 0.5...6
0.5...10 / 0.5...6
12 / 1.0 x 5.5 mm

IEC 60947-7-1 Ex eb II C Gb II 2 G D

IEC	UL	CSA	EN 60079-7
800	600	600	550
41	38	38	36
6	AWG 22...8	AWG 22...8	6 mm ²

8 kV / 3
A5 / V-0

TUEV16ATEX7909U

Rated connection
0.5...6 / 0.5...6
0.5...10 / 0.5...6
12 / 1.0 x 5.5 mm

Ordering data

Version	
	dark beige
	Blue
Note	

Type	Qty.	Order No.
A2C 6	50	1992110000
A2C 6 BL	50	1991790000

Type	Qty.	Order No.
A3C 6	50	1991820000
A3C 6 BL	50	1991830000

Accessories

Plug-in cross-connection	
	2-pole
	3-pole
	4-pole
End plate	
	dark beige
	Blue
End bracket	
	dark beige, screwable
	dark beige, direct mounting
Test adapter	
	1-pole
	stackable
Test plug	
Screwdriver	
	Standard
Marking tags	

Type	Qty.	Order No.
ZQV 6N/2	41 A 60	1985740000
ZQV 6N/3	41 A 60	1985760000
ZQV 6N/4	41 A 60	1985780000
AEP 2C 6	50	1991970000
AEP 2C 6 BL	50	1991950000
AEB 35 SC/1	50	1991920000
AEB 35 SCL/1 V0	20	2661280000
ATPG 1.5-10 L	0.2 A 50	1991890000
ATPG 6 MHR	0.2 A 50	1991930000
PS 2.0 MC	20	0310000000
SDIL 1,0X5,5X125	1	2749160000
DEK-A 5/8 MM WS	500	2448860000
WS-A 8/8 MM WS	500	2448930000
DEK 5/8 PLUS MC NE WS	800	1046350000
WS 10/8 PLUS MC NE WS	420	1905950000

Type	Qty.	Order No.
ZQV 6N/2	41 A 60	1985740000
ZQV 6N/3	41 A 60	1985760000
ZQV 6N/4	41 A 60	1985780000
AEP 3C 6	50	1991940000
AEP 3C 6 BL	20	1991910000
AEB 35 SC/1	50	1991920000
AEB 35 SCL/1 V0	20	2661280000
ATPG 1.5-10 L	0.2 A 50	1991890000
ATPG 6 MHR	0.2 A 50	1991930000
PS 2.0 MC	20	0310000000
SDIL 1,0X5,5X125	1	2749160000
DEK-A 5/8 MM WS	500	2448860000
WS-A 8/8 MM WS	500	2448930000
DEK 5/8 PLUS MC NE WS	800	1046350000
WS 10/8 PLUS MC NE WS	420	1905950000

For detailed information on other accessories and application in the online catalogue

A4C 6

6 mm²

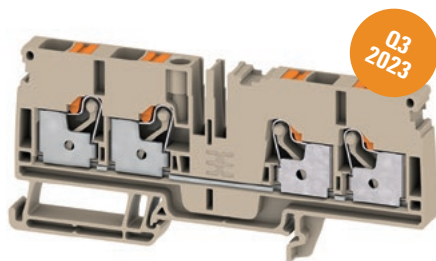

8.1 x 102 x 45.5

41 / 10

0.34...10

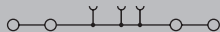

IEC 60947-7-1

IEC	UL	CSA	EN 60079-7
800			
41			
6			
		8 kV / 3	
		A5 / V-0	

Rated connection

0.5...6 / 0.5...6

0.5...10 / 0.5...6

12 / 1.0 x 5.5 mm

Type	Qty.	Order No.
A4C 6	50	2881450000
A4C 6 BL	50	2881460000

Type	Qty.	Order No.
ZQV 6N/2	41 A 60	1985740000
ZQV 6N/3	41 A 60	1985760000
ZQV 6N/4	41 A 60	1985780000
AEP 4C 6		2876180000
AEP 4C 6 BL		2876190000
AEB 35 SC/1	50	1991920000
AEB 35 SCL/1 VO	20	2661280000
ATPG 1.5-10 L	0.2 A 50	1991890000
ATPG 6 MI-R	0.2 A 50	1991930000
PS 2.0 MC	20	0310000000
SDIL 1,0x5,5x125	1	2749160000
DEKA 5/8 MM WS	500	2448860000
WS-A 8/8 MM WS	500	2448930000
DEK 5/8 PLUS MC NE WS	800	1046350000
WS 10/8 PLUS MC NE WS	420	1905950000



Spring connection with PUSH IN technology (A-Series) Feed-through terminal blocks

Universal range

A

ALO 6

6 mm²

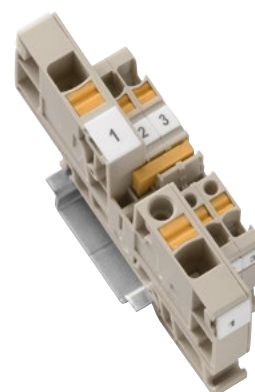

Width/Height/Depth	mm
max. current / max. cond. cross-section	A/mm ²
Max. clamping range	mm ²

9 x 77 x 45.5	
41 / 6	
0.34...6	

Technical data

Rated data	
Rated voltage	V
Rated current	A
for wire cross-section	mm ²
Rated impulse withstand voltage / Pollution severity	
Gauge to IEC 60947-1 / UL 94 flammability rating	
Approvals	
Clamped conductors (H05V/H07V)	
Solid / Stranded	mm ²
Flexible / Flexible with ferrule	mm ²
Stripping length / Blade size	mm/-
Note	

IEC 60947-7-1			
Ex eb II C Gb II 2 G D			
IEC	UL	CSA	EN 60079-7
800	600	600	550
41	38	38	33
6	AWG 22...8	AWG 22...8	6 mm ²
8 kV / 3			
A5 / V-0			
TUEV16ATEX7909U			
Rated connection			
0.5...6 / 0.5...10			
0.5...10 / 0.5...6			
12 / 1.0 x 5.5 mm			

Ordering data

Version	
	dark beige
	Blue
Note	

Type	Qty.	Order No.
ALO 6	20	1991780000
ALO 6 BL	20	2065120000

Accessories

Plug-in cross-connection	
	2-pole
	10-pole
	2-pole
	10-pole
End bracket	
	dark beige, screwable
	dark beige, direct mounting
Test adapter	
	1-pole
Test plug	
Screwdriver	
	Standard
Marking tags	

Type	Qty.	Order No.
ZQV 1.5N/2	17.5 A 60	1985410000
ZQV 1.5N/10	17.5 A 20	1985580000
ZQV 2.5N/2	24 A 60	1527540000
ZQV 2.5N/10	24 A 20	1527690000
End bracket		
AEB 35 SC/1	50	1991920000
AEB 35 SCL/1 V0	20	2661280000
Test adapter		
ATPG 1.5-10 L	0.2 A 50	1991890000
Test plug		
PS 2.0 MC	20	0310000000
Screwdriver		
SDIL 1,0X5,5X125	1	2749160000
Marking tags		
DEK-A 5/8 MM WS	500	2448860000
WS-A 8/8 MM WS	500	2448930000
DEK 5/8 PLUS MC NE WS	800	1046350000
WS 10/8 PLUS MC NE WS	420	1905950000

For detailed information on other accessories and application in the online catalogue

A2C 10

10 mm²

A3C 10

10 mm²

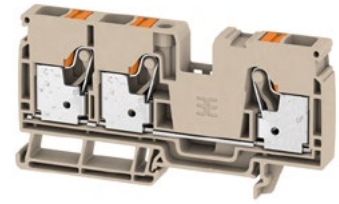

Width/Height/Depth	mm
max. current / max. cond. cross-section	A/mm ²
Max. clamping range	mm ²

10 x 80.5 x 51.5	
57 / 16	
0.5...16	

10 x 102 x 51.5	
57 / 16	
0.5...16	

Technical data

Rated data	
Rated voltage	V
Rated current	A
for wire cross-section	mm ²
Rated impulse withstand voltage / Pollution severity	
Gauge to IEC 60947-1 / UL 94 flammability rating	
Approvals	
Clamped conductors (H05V/H07V)	
Solid / Stranded	mm ²
Flexible / Flexible with ferrule	mm ²
Stripping length / Blade size	mm/-
Note	

DIN EN 60947-7-1	Ex eb II C Gb II 2 G D		
IEC	UL	CSA	EN 60079-7
1000	600	600	550
57	55	55	52
10	AWG 20...6	AWG 20...6	10 mm ²
8 kV / 3			
A6 / V-0			
UNDEFINED TEXT			
Rated connection			
0.5...10 / 0.5...16			
0.5...16 / 0.5...10			
18 / 1.0 x 5.5 mm			

DIN EN 60947-7-1	Ex eb II C Gb II 2 G D		
IEC	UL	CSA	EN 60079-7
1000	600	600	550
57	55	55	52
10	AWG 20...6	AWG 20...6	10 mm ²
8 kV / 3			
A6 / V-0			
UNDEFINED TEXT			
Rated connection			
0.5...10 / 0.5...16			
0.5...16 / 0.5...10			
18 / 1.0 x 5.5 mm			

Ordering data

Version	
	dark beige
	blue
Note	

Type	Qty.	Order No.
A2C 10	25	2490360000
A2C 10 BL	25	2490370000

Type	Qty.	Order No.
A3C 10	25	2490520000
A3C 10 BL	25	2490510000

Accessories

Plug-in cross-connection	2-pole
End plate	dark beige blue
End bracket	dark beige, screwable dark beige, direct mounting
Test adapter	1-pole
Test plug	
Screwdriver	Standard
Marking tags	

Type	Qty.	Order No.
ZQV 10N/2	57 A 25	2497250000
AEP 2C 10/16	20	2490380000
AEP 2C 10/16 BL	20	2490390000
AEB 35 SC/1	50	1991920000
AEB 35 SCL/1 V0	20	2661280000
ATPG 10 MI-R	0.2 A 50	1991870000
PS 2.0 MC	20	0310000000
SDIL 1,0X5,5X125	1	2749160000
DEK 5/5 PLUS MC NE WS	1000	1854490000
DEK 5/8 PLUS MC NE WS	800	1046350000
WS 10/8 PLUS MC NE WS	420	1905950000

Type	Qty.	Order No.
ZQV 10N/2	57 A 25	2497250000
AEP 3C 10/16	20	2490530000
AEP 3C 10/16 BL	20	2490540000
AEB 35 SC/1	50	1991920000
AEB 35 SCL/1 V0	20	2661280000
ATPG 10 MI-R	0.2 A 50	1991870000
PS 2.0 MC	20	0310000000
SDIL 1,0X5,5X125	1	2749160000
DEK 5/5 PLUS MC NE WS	1000	1854490000
DEK 5/8 PLUS MC NE WS	800	1046350000
WS 10/8 PLUS MC NE WS	420	1905950000

For detailed information on other accessories and application in the online catalogue



Spring connection with PUSH IN technology (A-Series)

Feed-through terminal blocks

A2C 16

16 mm²

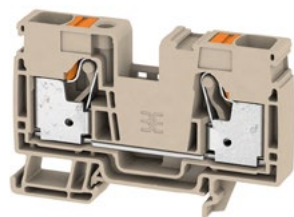

A3C 16

16 mm²

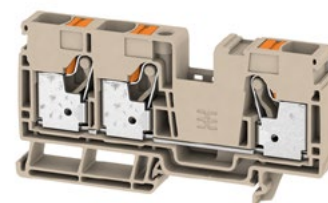

Width/Height/Depth	mm
max. current / max. cond. cross-section	A/mm ²
Max. clamping range	mm ²

12 x 80.5 x 51.5
76 / 25
0.5...25

12 x 102 x 51.5
76 / 25
0.5...25

Technical data

Rated data	
Rated voltage	V
Rated current	A
for wire cross-section	mm ²
Rated impulse withstand voltage / Pollution severity	
Gauge to IEC 60947-1 / UL 94 flammability rating	
Approvals	
Clamped conductors (H05V/H07V)	
Solid / Stranded	mm ²
Flexible / Flexible with ferrule	mm ²
Stripping length / Blade size	mm/-
Note	

IEC 60947-7-1			
IEC	UL	CSA	EN 60079-7
1000	600	600	550
76	62	62	64
16	AWG 18...6	AWG 18...6	16 mm ²
8 kV / 3			
A6 / V-0			
TUEV16ATEX7909U			
Rated connection			
0.5...16 / 10...25			
0.5...25 / 0.5...16			
18 / 1.0 x 5.5 mm			
Note			

IEC 60947-7-1			
IEC	UL	CSA	EN 60079-7
1000	600	600	550
76	62	62	64
16	AWG 18...6	AWG 18...6	16 mm ²
8 kV / 3			
A6 / V-0			
TUEV16ATEX7909U			
Rated connection			
0.5...16 / 10...25			
0.5...25 / 0.5...16			
18 / 1.0 x 5.5 mm			
Note			

Ordering data

Version	
	dark beige
	Blue
Note	

Type	Qty.	Order No.
A2C 16	20	2494000000
A2C 16 BL	20	2494100000
Note		

Type	Qty.	Order No.
A3C 16	20	2494090000
A3C 16 BL	20	2494080000
Note		

Accessories

Plug-in cross-connection	2-pole
End plate	dark beige blue
End bracket	dark beige, screwable dark beige, direct mounting
Test adapter	1-pole
Test plug	
Screwdriver	Standard
Marking tags	

Type	Qty.	Order No.
ZQV 16N/2	76 A 25	2497290000
AEP 2C 10/16	20	2490380000
AEP 2C 10/16 BL	20	2490390000
AEB 35 SC/1	50	1991920000
AEB 35 SCL/1 V0	20	2661280000
ATPG 1.5-10 L	0.2 A 50	1991890000
PS 2.0 MC	20	0310000000
SDIL 1,0X5,5X125	1	2749160000
DEK 5/5 PLUS MC NE WS	1000	1854490000
DEK 5/8 PLUS MC NE WS	800	1046350000
WS 10/8 PLUS MC NE WS	420	1905950000

Type	Qty.	Order No.
ZQV 16N/2	76 A 25	2497290000
AEP 3C 10/16	20	2490530000
AEP 3C 10/16 BL	20	2490540000
AEB 35 SC/1	50	1991920000
AEB 35 SCL/1 V0	20	2661280000
ATPG 1.5-10 L	0.2 A 50	1991890000
PS 2.0 MC	20	0310000000
SDIL 1,0X5,5X125	1	2749160000
DEK 5/5 PLUS MC NE WS	1000	1854490000
DEK 5/8 PLUS MC NE WS	800	1046350000
WS 10/8 PLUS MC NE WS	420	1905950000

For detailed information on other accessories and application in the online catalogue

ALO 16

16 mm²

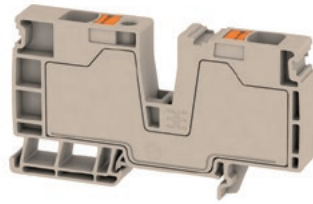

12 x 95.5 x 51.5
76 / 16
0.5...16

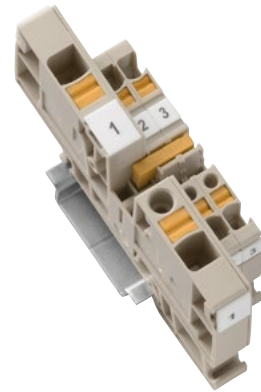

Width/Height/Depth mm
max. current / max. cond. cross-section A/mm²
Max. clamping range mm²

Technical data

Rated data	
Rated voltage	V
Rated current	A
for wire cross-section	mm ²
Rated impulse withstand voltage / Pollution severity	
Gauge to IEC 60947-1 / UL 94 flammability rating	
Approvals	
Clamped conductors (H05V/H07V)	
Solid / Stranded	mm ²
Flexible / Flexible with ferrule	mm ²
Stripping length / Blade size	mm/-

Note

Ordering data

Version	
	dark beige
	Blue
Note	

Accessories

Plug-in cross-connection	
	2-pole
	10-pole
	2-pole
	10-pole
	2-pole
	10-pole
	2-pole
End bracket	
	dark beige, screwable
	dark beige, direct mounting
Test adapter	
	1-pole
Test plug	
Screwdriver	
	Standard
Marking tags	

IEC 60947-7-1

IEC	UL	CSA	EN 60079-7
800	600	600	550
76	62	62	69
16	AWG 18...6	AWG 18...6	16 mm ²

8 kV / 3
A6 / V-0

® ® ® ® TÜV ATEX TUEV16ATEX7909U

Rated connection	
	0.5...10 / 0.5...25
	0.5...25 / 1.5...16
	18 / 1.0 x 5.5 mm

Type	Qty.	Order No.
ALO 16	20	2502280000
ALO 16 BL	20	2502320000

Type	Qty.	Order No.
ZQV 1.5N/2	17.5 A 60	1985410000
ZQV 1.5N/10	17.5 A 20	1985580000
ZQV 2.5N/2	24 A 60	1527540000
ZQV 2.5N/10	24 A 20	1527690000
ZQV 4N/2	32 A 60	1527930000
ZQV 4N/10	32 A 20	1528090000
ZQV 6N/2	41 A 60	1985740000
End bracket		
AEB 35 SC/1	50	1991920000
AEB 35 SCL/1 V0	20	2661280000
Test adapter		
ATPG 1.5-10 L	0.2 A 50	1991890000
Test plug		
PS 2.0 MC	20	0310000000
Screwdriver		
SDIL 1,0X5,5X125	1	2749160000
Marking tags		
DEK 5/5 PLUS MC NE WS	1000	1854490000
DEK 5/8 PLUS MC NE WS	800	1046350000
WS 10/8 PLUS MC NE WS	420	1905950000

For detailed information on other accessories and application in the online catalogue



Spring connection with PUSH IN technology (A-Series)
Feed-through terminal blocks

Universal range

A

A2C 35

35 mm²



A2C 35 DM

35 mm²



Width/Height/Depth	mm
max. current / max. cond. cross-section	A/mm ²
Max. clamping range	mm ²

16 x 101.5 x 71.5
125 / 35
2.5...35





16 x 135 x 71.5
125 / 35
2.5...35



Technical data

Rated data	
Rated voltage	V/V DC
Rated current	A
for wire cross-section	mm ²
Rated impulse withstand voltage / Pollution severity	
Gauge to IEC 60947-1 / UL 94 flammability rating	
Approvals	
Clamped conductors (H05V/H07V)	
Solid / Stranded	mm ²
Flexible / Flexible with ferrule	mm ²
Stripping length / Blade size	mm/-
Note	

IEC 60947-7-1			
IEC	UL	CSA	EN 60079-7
1000 / 1500	1000	1000	880
125	113	101	105
35	AWG 12...2	AWG 12...2	35 mm ²
8 kV / 3			
/ V-0			
			
TUEV16ATEX7909U			
Rated connection			
2.5...16 / 10...35			
10...35 / 2.5...35			
25 / 1.0 x 5.5 mm			
Note			

IEC 60947-7-1			
IEC	UL	CSA	EN 60079-7
1000 / 1500	1000	1000	880
125	113	101	105
35	AWG 12...2	AWG 12...2	35 mm ²
8 kV / 3			
/ V-0			
			
TUEV16ATEX7909U			
Rated connection			
2.5...16 / 10...35			
10...35 / 2.5...35			
25 / 1.0 x 5.5 mm			
Note			

Ordering data

Version	
	dark beige
	Blue
Note	

Type	Qty.	Order No.
A2C 35	10	2551510000
A2C 35 BL	10	2552090000
Note		

Type	Qty.	Order No.
A2C 35 DM	10	2551550000
A2C 35 BL DM	10	2552150000
Note		

Accessories

Plug-in cross-connection	
	2-pole
	2-pole
	2-pole
Additional tap	
	dark beige
	blue
	black/yellow
	green/yellow
End bracket	
	dark beige, screwable
	dark beige, direct mounting
Test adapter	
	1-pole
Test plug	
Screwdriver	
	Standard
Warning labels	
Marking tags	
Cross connections insertable	
	2-pole
	3-pole

Type	Qty.	Order No.
ZQV 35N/2	125 A 10	2634950000
ZQV 35N-10	57 A 10	2562670000
ZQV 35N-16	76 A 10	2562660000
AAC 35 2X6	41 A 5	2583090000
AAC 35 2X6 BL	41 A 5	2583170000
AAC 35 2X6 BK-YL	41 A 5	2583190000
AAC 35 2X6 GN-YL	41 A 5	2583180000
AEB 35 SC/1	50	1991920000
AEB 35 SCL/1 V0	20	2661280000
ATPG 1.5-10 L	0.2 A 50	1991890000
PS 2.0 MC	20	0310000000
SDS 1.0X5.5X150	1	2749380000
AAM 35-185 YE FLASH	40	2635600000
WS-A 8/16 MM WS	200	2619910000
Note		

Type	Qty.	Order No.
ZQV 35N/2	125 A 10	2634950000
ZQV 35N-10	57 A 10	2562670000
ZQV 35N-16	76 A 10	2562660000
AAC 35 2X6	41 A 5	2583090000
AAC 35 2X6 BL	41 A 5	2583170000
AAC 35 2X6 BK-YL	41 A 5	2583190000
AAC 35 2X6 GN-YL	41 A 5	2583180000
ATPG 1.5-10 L	0.2 A 50	1991890000
PS 2.0 MC	20	0310000000
SDS 1.0X5.5X150	1	2749380000
AAM 35-185 YE FLASH	40	2635600000
WS-A 8/16 MM WS	200	2619910000
Note		

For detailed information on other accessories and application in the online catalogue

Spring connection with PUSH IN technology (A-Series)
Feed-through terminal blocks

Universal range

A

A2C 95/120 DM

95 mm²

A2C 150/185

150 mm²



Q3
2023

Width/Height/Depth	mm
max. current / max. cond. cross-section	A/mm ²
Max. clamping range	mm ²

25 x 133.5 x 90
232 / 120
25...120

34 x 118.5 x 98
309 / 185
25...185

Technical data

Rated data	
Rated voltage	V/V DC
Rated current	A
for wire cross-section	mm ²
Rated impulse withstand voltage / Pollution severity	
Gauge to IEC 60947-1 / UL 94 flammability rating	
Approvals	
Clamped conductors (H05V/H07V)	
Solid / Stranded	mm ²
Flexible / Flexible with ferrule	mm ²
Stripping length / Blade size	mm/-
Note	

IEC 60947-7-1			
IEC	UL	CSA	EN 60079-7
1000 / 1500	600		
232	255		
95	AWG 4...250		
8 kV / 3			
/ V-0			
Rated connection			
25...120 / 25...120			
25...120 / 25...95			
40 / 1.0 x 5.5 mm			
If a cross-connection is mounted next to a PE terminal block or a terminal block for direct mounting, the rated voltage is reduced to 1000 V DC.			

IEC 60947-7-1			
IEC	UL	CSA	EN 60079-7
1000 / 1500			
309			
150			
8 kV / 3			
B13 / V-0			
Rated connection			
50...185 / 50...185			
50...185 / 50...150			
40 / 1.0 x 5.5 mm			
If a cross-connection is mounted next to a PE terminal block or a terminal block for direct mounting, the rated voltage is reduced to 1000 V DC.			

Ordering data

Version	
	dark beige
	Blue
Note	

Type	Qty.	Order No.
A2C 95/120-DM	5	2694150000
A2C 95/120 BL-DM	5	2694160000

Type	Qty.	Order No.
A2C 150/185	5	2728700000
A2C 150/185 BL	5	2728710000

Accessories

Plug-in cross-connection	
	2-pole
	2-pole
	2-pole
Additional tap	
	dark beige
	blue
	black/yellow
	green/yellow
End bracket	
	dark beige, screwable
	dark beige, direct mounting
Test adapter	
	1-pole
Test plug	
Screwdriver	
	Standard
Warning labels	
Marking tags	
Cross connections insertable	
	2-pole
	3-pole

Type	Qty.	Order No.
AAC 50-185 2X10	57 A	5 2663420000
AAC 50-185 2X10 BL	57 A	5 2663430000
AAC 50-185 2X10 BK-YL	57 A	5 2663450000
AAC 50-185 2X10 GN-YL	57 A	5 2663440000
ATPG 1.5-10 L	0.2 A	50 1991890000
PS 2.0 MC		20 0310000000
SDS 1.0X5.5X150		1 2749380000
AAM 35-185 YE FLASH		40 2635600000
WS-A 8/16 MM WS		200 2619910000
ZQV 95/120N/2	192 A	10 2694250000
ZQV 95/120N/3	192 A	10 2694260000

Type	Qty.	Order No.
AAC 50-185 2X10	57 A	5 2663420000
AAC 50-185 2X10 BL	57 A	5 2663430000
AAC 50-185 2X10 BK-YL	57 A	5 2663450000
AAC 50-185 2X10 GN-YL	57 A	5 2663440000
AEB 35 SC/1		50 1991920000
AEB 35 SCL/1 V0		20 2661280000
ATPG 1.5-10 L	0.2 A	50 1991890000
PS 2.0 MC		20 0310000000
SDS 1.0X5.5X150		1 2749380000
AAM 35-185 YE FLASH		40 2635600000
WS-A 8/16 MM WS		200 2619910000
ZQV 150/185N/2	232 A	5 2728840000
ZQV 150/185N/3	232 A	5 2728850000

For detailed information on other accessories and application in the online catalogue

A2C 150/185 DM

150 mm²



34 x 151 x 98
309 / 185
25...185

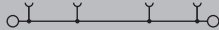

IEC 60947-7-1

IEC	UL	CSA	EN 60079-7
1000 / 1500			
309			
150			
	8 kV / 3		
	B13 / V-0		

Rated connection

50...185 / 50...185
50...185 / 50...150
40 / 1.0 x 5.5 mm

If a cross-connection is mounted next to a PE terminal block or a terminal block for direct mounting, the rated voltage is reduced to 1000 V DC.

Type	Qty.	Order No.
A2C 150/185-DM	1	2728770000
A2C 150/185 BL-DM	5	2728780000

Type	Qty.	Order No.	
AAC 50-185 2X10	57 A	5	2663420000
AAC 50-185 2X10 BL	57 A	5	2663430000
AAC 50-185 2X10 BK-YL	57 A	5	2663450000
AAC 50-185 2X10 GN-YL	57 A	5	2663440000
ATPG 1.5-10 L	0.2 A	50	1991890000
PS 2.0 MC		20	0310000000
SDS 1.0X5.5X150		1	2749380000
AAM 35-185 YE FLASH		40	2635600000
WS-A 8/16 MM WS		200	2619910000
ZQV 150/185N/2	232 A	5	2728840000
ZQV 150/185N/3	232 A	5	2728850000



Spring connection with PUSH IN technology (A-Series)
Feed-through terminal blocks

Universal range

A

A2T 1.5

1.5 mm²

A2T 1.5 VL

1.5 mm²

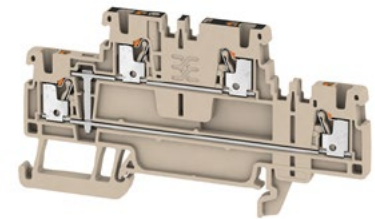
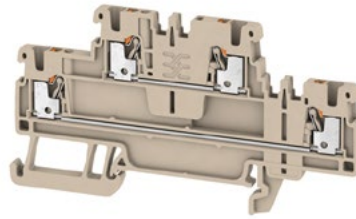

Width/Height/Depth	mm
max. current / max. cond. cross-section	A/mm ²
Max. clamping range	mm ²

3.5 x 84 x 45	
16 / 1.5	
0.14...1.5	

3.5 x 84 x 45	
16 / 1.5	
0.14...1.5	

Technical data

Rated data	
Rated voltage	V/-
Rated current	A
for wire cross-section	mm ²
Rated impulse withstand voltage / Pollution severity	
Gauge to IEC 60947-1 / UL 94 flammability rating	
Approvals	
Clamped conductors (H05V/H07V)	
Solid / Stranded	mm ²
Flexible / Flexible with ferrule	mm ²
Stripping length / Blade size	mm/-
Note	

IEC 60947-7-1				Ex eb II	C Gb		II 2 G D
IEC	UL	CSA	EN 60079-7				
500 /	300	300	440				
16	13	13	13.5				
1.5	AWG 26...14	AWG 26...14	1.5 mm ²				
6 kV / 3							
A1 / V-0							
				TUEV16ATEX7909U			
Rated connection							
0.5...1.5 / 0.5...1.5							
0.5...1.5 / 0.5...1							
8 / 0.4 x 2.0 mm							

IEC 60947-7-1				Ex eb II	C Gb		II 2 G D
IEC	UL	CSA	EN 60079-7				
500 /	300	300	440				
17.5	13	13	13.5				
1.5	AWG 26...14	AWG 26...14	1.5 mm ²				
6 kV / 3							
A1 / V-0							
				TUEV16ATEX7909U			
Rated connection							
0.5...1.5 / 0.5...1.5							
0.5...1.5 / 0.5...1							
8 / 0.4 x 2.0 mm							

Ordering data

Version	
	dark beige
	Blue
Note	

Type	Qty.	Order No.
A2T 1.5	50	2469370000
A2T 1.5 BL	50	2471430000

Type	Qty.	Order No.
A2T 1.5 VL	50	2469400000
A2T 1.5 VL BL	50	2471450000

Accessories

Plug-in cross-connection	
	2-pole
	10-pole
End plate	
	dark beige
	Blue
End bracket	
	dark beige, screwable
	dark beige, direct mounting
Test adapter	
	1-pole
	stackable
Test plug	
Screwdriver	
	Standard
Marking tags	

Type	Qty.	Order No.	
ZQV 1.5N/2	17.5 A	60	1985410000
ZQV 1.5N/10	17.5 A	20	1985580000
AEP 2T 1.5			
AEP 2T 1.5	20	2469420000	
AEP 2T 1.5 BL	20	2471470000	
AEB 35 SC/1			
AEB 35 SC/1	50	1991920000	
AEB 35 SCL/1 VO	20	2661280000	
ATPG 1.5-10 L			
ATPG 1.5-10 L	0.2 A	50	1991890000
ATPG 1.5 MHR	0.2 A	50	1991880000
PS 2.0 MC			
PS 2.0 MC	20	0310000000	
SDS 0.4X2.0X60			
SDS 0.4X2.0X60	1	2749260000	
WS 10/3.5 PLUS MC NE WS			
WS 10/3.5 PLUS MC NE WS	960	2003760000	
DEK 5/3.5 MM WS			
DEK 5/3.5 MM WS	1000	2007100000	
DEK 5/3.5 PLUS MC NE WS			
DEK 5/3.5 PLUS MC NE WS	1600	2003750000	
SNAPMARK 1.5			
SNAPMARK 1.5	40	2682080000	

Type	Qty.	Order No.	
ZQV 1.5N/2	17.5 A	60	1985410000
ZQV 1.5N/10	17.5 A	20	1985580000
AEP 2T 1.5			
AEP 2T 1.5	20	2469420000	
AEP 2T 1.5 BL	20	2471470000	
AEB 35 SC/1			
AEB 35 SC/1	50	1991920000	
AEB 35 SCL/1 VO	20	2661280000	
ATPG 1.5-10 L			
ATPG 1.5-10 L	0.2 A	50	1991890000
ATPG 1.5 MHR	0.2 A	50	1991880000
PS 2.0 MC			
PS 2.0 MC	20	0310000000	
SDS 0.4X2.0X60			
SDS 0.4X2.0X60	1	2749260000	
WS 10/3.5 PLUS MC NE WS			
WS 10/3.5 PLUS MC NE WS	960	2003760000	
DEK 5/3.5 MM WS			
DEK 5/3.5 MM WS	1000	2007100000	
DEK 5/3.5 PLUS MC NE WS			
DEK 5/3.5 PLUS MC NE WS	1600	2003750000	
SNAPMARK 1.5			
SNAPMARK 1.5	40	2682080000	

For detailed information on other accessories and application in the online catalogue

A2T 1.5 FT-PE

1.5 mm²

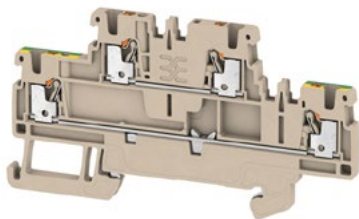

3.5 x 84 x 45
16 / 1.5
0.14...1.5

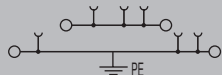

IEC 60947-7-1, IEC 60947-7-2
Ex eb II
C Gb II 2 G D

IEC	UL	CSA	EN 60079-7
500 /	300	300	440
16	13	13	13.5
1.5	AWG 26...14	AWG 26...14	1.5 mm ²

6 kV / 3

A1 / V-0

TUEV16ATEX7909U

Rated connection

0.5...1.5 / 0.5...1.5

0.5...1.5 / 0.5...1

8 / 0.4 x 2.0 mm

Type	Qty.	Order No.
A2T 1.5 FT-PE	50	2469390000

Type	Qty.	Order No.	
ZQV 1.5N/2	17.5 A	60	1985410000
ZQV 1.5N/10	17.5 A	20	1985580000
AEP 2T 1.5	20	2469420000	
AEP 2T 1.5 BL	20	2471470000	
AEB 35 SC/1	50	1991920000	
AEB 35 SCL/1 VO	20	2661280000	
ATPG 1.5-10 L	0.2 A	50	1991890000
ATPG 1.5 MI-R	0.2 A	50	1991880000
PS 2.0 MC	20	0310000000	
SDS 0.4X2.0X60	1	2749260000	
WS 10/3.5 PLUS MC NE WS	960	2003760000	
DEK 5/3.5 MM WS	1000	2007100000	
DEK 5/3.5 PLUS MC NE WS	1600	2003750000	
SNAPMARK 1.5	40	2682080000	



Spring connection with PUSH IN technology (A-Series)
Feed-through terminal blocks

Universal range

A

A2T 2.5

2.5 mm²

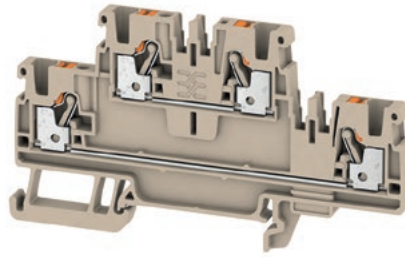

A2T 2.5 SNAPMARK

2.5 mm²

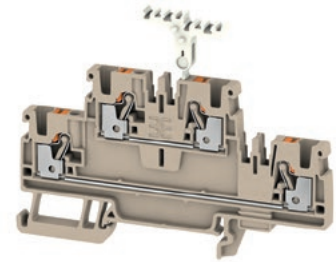

Width/Height/Depth	mm
max. current / max. cond. cross-section	A/mm ²
Max. clamping range	mm ²

5.1 x 90 x 50.5	
24 / 4	
0.14...4	

5.1 x 90 x 69	
24 / 4	
0.14...4	

Technical data

Rated data	
Rated voltage	V
Rated current	A
for wire cross-section	mm ²
Rated impulse withstand voltage / Pollution severity	
Gauge to IEC 60947-1 / UL 94 flammability rating	
Approvals	
Clamped conductors (H05V/H07V)	
Solid / Stranded	mm ²
Flexible / Flexible with ferrule	mm ²
Stripping length / Blade size	mm/-
Note	

IEC 60947-7-1

Ex eb II
C Gb II 2 G D

IEC	UL	CSA	EN 60079-7
800	600	600	550
24	20	20	21
2.5	AWG 28...12	AWG 28...12	2.5 mm ²
8 kV / 3			
A3 / V-0			
TUEV16ATEX7909U			
Rated connection			
0.5...2.5 / 0.5...4			
0.5...4 / 0.5...2.5			
10 / 0.6 x 3.5 mm			

IEC 60947-7-1

IEC	UL	CSA	EN 60079-7
800	600	600	550
24	20	20	19
2.5	AWG 28...12	AWG 28...12	2.5 mm ²
8 kV / 3			
A3 / V-0			
TUEV16ATEX7909U			
Rated connection			
0.5...2.5 / 0.5...4			
0.5...4 / 0.5...2.5			
10 / 0.6 x 3.5 mm			

Ordering data

Version	
	dark beige
	Blue
Note	

Type	Qty.	Order No.
A2T 2.5	50	1547610000
A2T 2.5 BL	50	1547620000

Type	Qty.	Order No.
A2T 2.5 SNAPMARK	50	2581250000
A2T 2.5 SNAPMARK BL	50	2581280000

Accessories

Plug-in cross-connection	
	2-pole
	10-pole
	2-pole
	10-pole
	2-pole
	10-pole
End plate	
	dark beige
	blue
End bracket	
	dark beige, screwable
	dark beige, direct mounting
Test adapter	
	1-pole
	stackable
	3-pole
	5-pole
Test plug	
Screwdriver	
	Standard
Marking tags	

Type	Qty.	Order No.
ZQV 2.5N/2	24 A 60	1527540000
ZQV 2.5N/10	24 A 20	1527690000
AEP 2T 2.5		
AEP 2T 2.5	20	1547690000
AEP 2T 2.5 BL	20	1547700000
AEB 35 SC/1		
AEB 35 SC/1	50	1991920000
AEB 35 SCL/1 V0	20	2661280000
ATPG 1.5-10 L		
ATPG 1.5-10 L	0.2 A 50	1991890000
ATPG 2.5 MHR		
ATPG 2.5 MHR	0.2 A 50	1991960000
ATPG 2.5/3		
ATPG 2.5/3	0.2 A 25	2041190000
ATPG 2.5/5		
ATPG 2.5/5	0.2 A 25	2041180000
PS 2.0 MC		
PS 2.0 MC	20	0310000000
SDIL 0,6X3,5X100		
SDIL 0,6X3,5X100	1	2749140000
DEK 5/5 PLUS MC NE WS		
DEK 5/5 PLUS MC NE WS	1000	1854490000
DEK 5/5 MM WS		
DEK 5/5 MM WS	800	2007110000
WS 8/5 MM WS		
WS 8/5 MM WS	800	2007150000
WS 10/5 M PLUS MC NE WS		
WS 10/5 M PLUS MC NE WS	600	2003770000

Type	Qty.	Order No.
ZQV 2.5N/2	24 A 60	1527540000
ZQV 2.5N/10	24 A 20	1527690000
AEP 3T 2.5		
AEP 3T 2.5	20	2428560000
AEP 3T 2.5 BL	20	2428860000
AEB 35 SC/1		
AEB 35 SC/1	50	1991920000
AEB 35 SCL/1 V0	20	2661280000
ATPG 1.5-10 L		
ATPG 1.5-10 L	0.2 A 50	1991890000
ATPG 2.5 MHR		
ATPG 2.5 MHR	0.2 A 50	1991960000
ATPG 2.5/3		
ATPG 2.5/3	0.2 A 25	2041190000
ATPG 2.5/5		
ATPG 2.5/5	0.2 A 25	2041180000
PS 2.0 MC		
PS 2.0 MC	20	0310000000
SDIL 0,6X3,5X100		
SDIL 0,6X3,5X100	1	2749140000
DEK 5/5 PLUS MC NE WS		
DEK 5/5 PLUS MC NE WS	1000	1854490000
DEK 5/5 MM WS		
DEK 5/5 MM WS	800	2007110000
WS 8/5 MM WS		
WS 8/5 MM WS	800	2007150000
WS 10/5 M PLUS MC NE WS		
WS 10/5 M PLUS MC NE WS	600	2003770000

For detailed information on other accessories and application in the online catalogue

A2T 2.5 VL

2.5 mm²

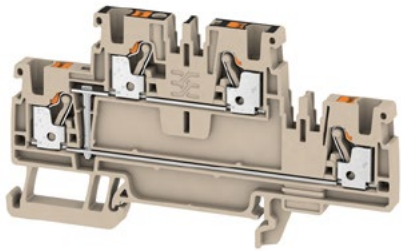

5.1 x 90 x 50.5
24 / 4
0.14...4

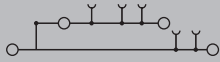

IEC 60947-7-1 Ex eb II C Gb II 2 G D

IEC	UL	CSA	EN 60079-7
800	600	600	550
24	20	20	21
2.5	AWG 28...12	AWG 28...12	2.5 mm ²

8 kV / 3
A3 / V-0

TUEV16ATEX7909U

Rated connection

0.5...2.5 / 0.5...4
0.5...4 / 0.5...2.5
10 / 0.6 x 3.5 mm

Type	Qty.	Order No.
A2T 2.5 VL	50	1547650000
A2T 2.5 VL BL	50	1547660000

Type	Qty.	Order No.
ZQV 2.5N/2	24 A 60	1527540000
ZQV 2.5N/10	24 A 20	1527690000

AEP 2T 2.5	20	1547690000
AEP 2T 2.5 BL	20	1547700000

AEB 35 SC/1	50	1991920000
AEB 35 SCL/1 VO	20	2661280000

ATPG 1.5-10 L	0.2 A 50	1991890000
ATPG 2.5 MI-R	0.2 A 50	1991960000
ATPG 2.5/3	0.2 A 25	2041190000
ATPG 2.5/5	0.2 A 25	2041180000

PS 2.0 MC	20	0310000000
-----------	----	------------

SDIL 0,6X3,5X100	1	2749140000
------------------	---	------------

DEK 5/5 PLUS MC NE WS	1000	1854490000
DEK 5/5 MM WS	800	2007110000
WS 8/5 MM WS	800	2007150000
WS 10/5 M PLUS MC NE WS	600	2003770000

A2T 2.5 FT-PE

2.5 mm²

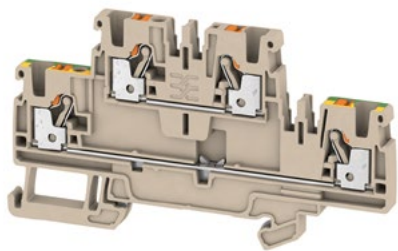

5.1 x 90 x 50.5
24 / 4
0.14...4



IEC 60947-7-1, IEC 60947-7-2 Ex eb II C Gb II 2 G D

IEC	UL	CSA	EN 60079-7
800	600	600	550
24	20	20	21
2.5	AWG 28...12	AWG 28...12	2.5 mm ²

8 kV / 3
A3 / V-0

TUEV16ATEX7909U

Rated connection

0.5...2.5 / 0.5...4
0.5...4 / 0.5...2.5
10 / 0.6 x 3.5 mm

Type	Qty.	Order No.
A2T 2.5 FT-PE	50	1547640000

Type	Qty.	Order No.
ZQV 2.5N/2	24 A 60	1527540000
ZQV 2.5N/10	24 A 20	1527690000

AEP 2T 2.5	20	1547690000
AEP 2T 2.5 BL	20	1547700000

AEB 35 SC/1	50	1991920000
AEB 35 SCL/1 VO	20	2661280000

ATPG 1.5-10 L	0.2 A 50	1991890000
ATPG 2.5 MI-R	0.2 A 50	1991960000
ATPG 2.5/3	0.2 A 25	2041190000
ATPG 2.5/5	0.2 A 25	2041180000

PS 2.0 MC	20	0310000000
-----------	----	------------

SDIL 0,6X3,5X100	1	2749140000
------------------	---	------------

DEK 5/5 PLUS MC NE WS	1000	1854490000
DEK 5/5 MM WS	800	2007110000
WS 8/5 MM WS	800	2007150000
WS 10/5 M PLUS MC NE WS	600	2003770000

A2T 2.5 N-FT

2.5 mm²

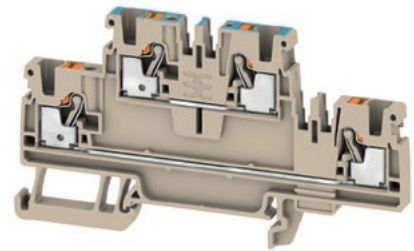

5.1 x 90 x 50.5
24 / 4
0.14...4



IEC 60947-7-1

IEC	UL	CSA	EN 60079-7
800			
24			
2.5			

8 kV / 3
/ V-0

CE

Rated connection

0.5...2.5 / 0.5...4
0.5...4 / 0.5...2.5
10 / 0.6 x 3.5 mm

Type	Qty.	Order No.
A2T 2.5 N-FT	50	2723370000

Type	Qty.	Order No.
ZQV 2.5N/2	24 A 60	1527540000
ZQV 2.5N/10	24 A 20	1527690000

AEP 2T 2.5	20	1547690000
AEP 2T 2.5 BL	20	1547700000

AEB 35 SC/1	50	1991920000
AEB 35 SCL/1 VO	20	2661280000

ATPG 1.5-10 L	0.2 A 50	1991890000
ATPG 2.5 MI-R	0.2 A 50	1991960000
ATPG 2.5/3	0.2 A 25	2041190000
ATPG 2.5/5	0.2 A 25	2041180000

PS 2.0 MC	20	0310000000
-----------	----	------------

SDIL 0,6X3,5X100	1	2749140000
------------------	---	------------

DEK 5/5 PLUS MC NE WS	1000	1854490000
DEK 5/5 MM WS	800	2007110000
WS 8/5 MM WS	800	2007150000
WS 10/5 M PLUS MC NE WS	600	2003770000



A2T 2.5 3C

2.5 mm²

A2T 2.5 3C VL

2.5 mm²



Width/Height/Depth	mm
max. current / max. cond. cross-section	A/mm ²
Max. clamping range	mm ²

5.1 x 114.5 x 64
22 / 4
0.14...4

5.1 x 114.5 x 64
22 / 4
0.14...4

Technical data

Rated data	
Rated voltage	V
Rated current	A
for wire cross-section	mm ²
Rated impulse withstand voltage / Pollution severity	
Gauge to IEC 60947-1 / UL 94 flammability rating	
Approvals	
Clamped conductors (H05V/H07V)	
Solid / Stranded	mm ²
Flexible / Flexible with ferrule	mm ²
Stripping length / Blade size	mm/-
Note	

IEC 60947-7-1			
Ex eb II C Gb II 2 G D			
IEC	UL	CSA	EN 60079-7
800	300		550
22	20		19
2.5	AWG 28...12		2.5 mm ²
8 kV / 3			
A3 / V-0			
TUEV16ATEX7909U			
Rated connection			
0.5...2.5 / 0.5...4			
0.5...4 / 0.5...2.5			
10 / 0.6 x 3.5 mm			

IEC 60947-7-1			
Ex eb II C Gb II 2 G D			
IEC	UL	CSA	EN 60079-7
800	300		550
22	20		19
2.5	AWG 28...12		2.5 mm ²
8 kV / 3			
A3 / V-0			
TUEV16ATEX7909U			
Rated connection			
0.5...2.5 / 0.5...4			
0.5...4 / 0.5...2.5			
10 / 0.6 x 3.5 mm			

Ordering data

Version	
	dark beige
	Blue
Note	

Type	Qty.	Order No.
A2T 2.5 3C	50	2531290000
A2T 2.5 3C BL	50	2531510000

Type	Qty.	Order No.
A2T 2.5 3C VL	50	2531310000
A2T 2.5 3C VL BL	50	2531530000

Accessories

Plug-in cross-connection	
	2-pole
	10-pole
	2-pole
	10-pole
	2-pole
	10-pole
End plate	
	dark beige
	Blue
End bracket	
	dark beige, screwable
	dark beige, direct mounting
Test adapter	
	1-pole
	stackable
	3-pole
	5-pole
Test plug	
Screwdriver	
	Standard
Marking tags	

Type	Qty.	Order No.
ZQV 2.5N/2	24 A 60	1527540000
ZQV 2.5N/10	24 A 20	1527690000
End plate		
AEP 2T 2.5 3C	20	2532690000
AEP 2T 2.5 3C BL	20	2532700000
End bracket		
AEB 35 SC/1	50	1991920000
AEB 35 SCL/1 V0	20	2661280000
Test adapter		
ATPG 1.5-10 L	0.2 A 50	1991890000
ATPG 2.5 MHR	0.2 A 50	1991960000
ATPG 2.5/3	0.2 A 25	2041190000
ATPG 2.5/5	0.2 A 25	2041180000
Test plug		
PS 2.0 MC	20	0310000000
Screwdriver		
SDIL 0,6X3,5X100	1	2749140000
Marking tags		
DEK 5/5 PLUS MC NE WS	1000	1854490000
DEK 5/5 MM WS	800	2007110000
WS 8/5 MM WS	800	2007150000
WS 10/5 M PLUS MC NE WS	600	2003770000

Type	Qty.	Order No.
ZQV 2.5N/2	24 A 60	1527540000
ZQV 2.5N/10	24 A 20	1527690000
End plate		
AEP 2T 2.5	20	1547690000
AEP 2T 2.5 BL	20	1547700000
End bracket		
AEB 35 SC/1	50	1991920000
AEB 35 SCL/1 V0	20	2661280000
Test adapter		
ATPG 1.5-10 L	0.2 A 50	1991890000
ATPG 2.5 MHR	0.2 A 50	1991960000
ATPG 2.5/3	0.2 A 25	2041190000
ATPG 2.5/5	0.2 A 25	2041180000
Test plug		
PS 2.0 MC	20	0310000000
Screwdriver		
SDIL 0,6X3,5X100	1	2749140000
Marking tags		
DEK 5/5 PLUS MC NE WS	1000	1854490000
DEK 5/5 MM WS	800	2007110000
WS 8/5 MM WS	800	2007150000
WS 10/5 M PLUS MC NE WS	600	2003770000

For detailed information on other accessories and application in the online catalogue

A2T 2.5 3C N-FT

2.5 mm²

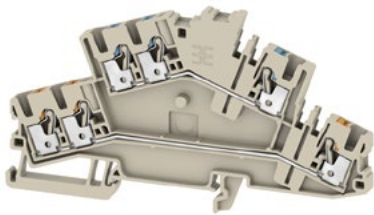

5.1 x 114.5 x 64
22 / 4
0.14...4

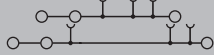

IEC 60947-7-1

IEC	UL	CSA	EN 60079-7
800			550
22			19
2.5			2.5 mm ²
8 kV / 3 / V-0			

CE TÜV SÜD KEMA KE A3 / V-0 TUEV16ATEX7909U

Rated connection
0.5...2.5 / 0.5...4
0.5...4 / 0.5...2.5
10 / 0.6 x 3.5 mm

A2T 2.5 3C FT-PE

2.5 mm²

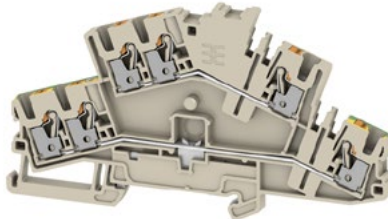

5.1 x 114.5 x 64
22 / 4
0.14...4

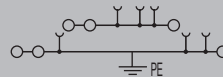

IEC 60947-7-1

IEC	UL	CSA	EN 60079-7
800	300		550
22	20		19
2.5	AWG 28...12		2.5 mm ²
8 kV / 3 / V-0			

CE TÜV SÜD KEMA KE A3 / V-0 TUEV16ATEX7909U

Rated connection
0.5...2.5 / 0.5...4
0.5...4 / 0.5...2.5
10 / 0.6 x 3.5 mm

A2T 2.5 3C N-PE

2.5 mm²

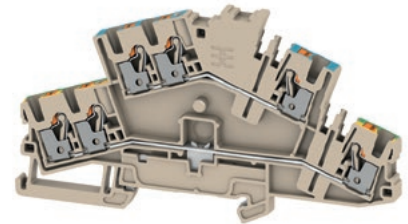

5.1 x 114.5 x 64
22 / 4
0.14...4

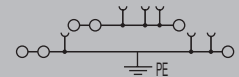

IEC 60947-7-1

IEC	UL	CSA	EN 60079-7
800			550
22			19
2.5			2.5 mm ²
8 kV / 3 / V-0			

CE TÜV SÜD KEMA KE A3 / V-0 TUEV16ATEX7909U

Rated connection
0.5...2.5 / 0.5...4
0.5...4 / 0.5...2.5
10 / 0.6 x 3.5 mm

Type	Qty.	Order No.
A2T 2.5 3C N-FT	50	2736830000

Type	Qty.	Order No.
A2T 2.5 3C FT-PE	50	2531300000

Type	Qty.	Order No.
A2T 2.5 3C N-PE	50	2623550000

Type	Qty.	Order No.
ZQV 2.5N/2	24 A 60	1527540000
ZQV 2.5N/10	24 A 20	1527690000
AEP 2T 2.5	20	1547690000
AEP 2T 2.5 BL	20	1547700000
AEB 35 SC/1	50	1991920000
AEB 35 SCL/1 V0	20	2661280000
ATPG 1.5-10 L	0.2 A 50	1991890000
ATPG 2.5 MI-R	0.2 A 50	1991960000
ATPG 2.5/3	0.2 A 25	2041190000
ATPG 2.5/5	0.2 A 25	2041180000
PS 2.0 MC	20	0310000000
SDIL 0,6X3,5X100	1	2749140000
DEK 5/5 PLUS MC NE WS	1000	1854490000
DEK 5/5 MM WS	800	2007110000
WS 8/5 MM WS	800	2007150000
WS 10/5 M PLUS MC NE WS	600	2003770000

Type	Qty.	Order No.
ZQV 2.5N/2	24 A 60	1527540000
ZQV 2.5N/10	24 A 20	1527690000
AEP 2T 2.5	20	1547690000
AEP 2T 2.5 BL	20	1547700000
AEB 35 SC/1	50	1991920000
AEB 35 SCL/1 V0	20	2661280000
ATPG 1.5-10 L	0.2 A 50	1991890000
ATPG 2.5 MI-R	0.2 A 50	1991960000
ATPG 2.5/3	0.2 A 25	2041190000
ATPG 2.5/5	0.2 A 25	2041180000
PS 2.0 MC	20	0310000000
SDIL 0,6X3,5X100	1	2749140000
DEK 5/5 PLUS MC NE WS	1000	1854490000
DEK 5/5 MM WS	800	2007110000
WS 8/5 MM WS	800	2007150000
WS 10/5 M PLUS MC NE WS	600	2003770000

Type	Qty.	Order No.
ZQV 2.5N/2	24 A 60	1527540000
ZQV 2.5N/10	24 A 20	1527690000
AEP 2T 2.5	20	1547690000
AEP 2T 2.5 BL	20	1547700000
AEB 35 SC/1	50	1991920000
AEB 35 SCL/1 V0	20	2661280000
ATPG 1.5-10 L	0.2 A 50	1991890000
ATPG 2.5 MI-R	0.2 A 50	1991960000
ATPG 2.5/3	0.2 A 25	2041190000
ATPG 2.5/5	0.2 A 25	2041180000
PS 2.0 MC	20	0310000000
SDIL 0,6X3,5X100	1	2749140000
DEK 5/5 PLUS MC NE WS	1000	1854490000
DEK 5/5 MM WS	800	2007110000
WS 8/5 MM WS	800	2007150000
WS 10/5 M PLUS MC NE WS	600	2003770000



Spring connection with PUSH IN technology (A-Series)
Feed-through terminal blocks

Universal range

A

A2T 4

4 mm²

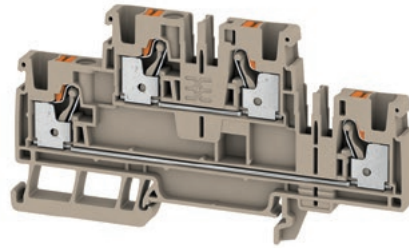

A2T 4 VL

4 mm²

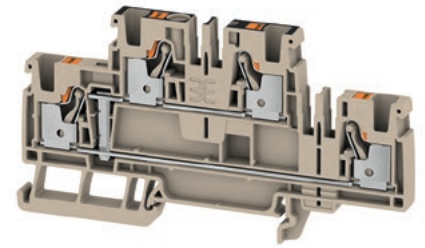

Width/Height/Depth	mm
max. current / max. cond. cross-section	A/mm ²
Max. clamping range	mm ²

6.1 x 100 x 53.5	
32 / 6	
0.14...6	

6.1 x 100 x 53.5	
32 / 6	
0.14...6	

Technical data

Rated data	
Rated voltage	V
Rated current	A
for wire cross-section	mm ²
Rated impulse withstand voltage / Pollution severity	
Gauge to IEC 60947-1 / UL 94 flammability rating	
Approvals	
Clamped conductors (H05V/H07V)	
Solid / Stranded	mm ²
Flexible / Flexible with ferrule	mm ²
Stripping length / Blade size	mm/-
Note	

IEC 60947-7-1			
IEC	UL	CSA	EN 60079-7
800	600		550
32	30		25
4	AWG 26...10		4 mm ²
8 kV / 3			
A4 / V-0			
		TUEV16ATEX7909U	
Rated connection			
0.5...4 / 0.5...6			
0.5...6 / 0.5...4			
12 / 0.6 x 3.5 mm			
Note			

IEC 60947-7-1			
IEC	UL	CSA	EN 60079-7
800	600		550
32	30		25
4	AWG 26...10		4 mm ²
8 kV / 3			
A4 / V-0			
		TUEV16ATEX7909U	
Rated connection			
0.5...4 / 0.5...6			
0.5...6 / 0.5...4			
12 / 0.6 x 3.5 mm			
Note			

Ordering data

Version	
	dark beige
	Blue
Note	

Type	Qty.	Order No.
A2T 4	50	2539970000
A2T 4 BL	50	2540040000
Note		

Type	Qty.	Order No.
A2T 4 VL	50	2540020000
A2T 4 VL BL	50	2540030000
Note		

Accessories

Plug-in cross-connection	
	2-pole
	10-pole
	2-pole
	10-pole
	2-pole
	10-pole
End plate	
	dark beige
	blue
End bracket	
	dark beige, screwable
	dark beige, direct mounting
Test adapter	
	1-pole
	stackable
	3-pole
	5-pole
Test plug	
Screwdriver	
	Standard
Marking tags	

Type	Qty.	Order No.
ZQV 4N/2	32 A 60	1527930000
ZQV 4N/10	32 A 20	1528090000
End plate		
AEP 2T 4	20	2540000000
AEP 2T 4 BL	20	2540010000
End bracket		
AEB 35 SC/1	50	1991920000
AEB 35 SCL/1 VO	20	2661280000
Test adapter		
ATPG 1.5-10 L	0.2 A 50	1991890000
ATPG 4 MHR	0.2 A 50	1991860000
Test plug		
PS 2.0 MC	20	0310000000
Screwdriver		
SDIL 0,6X3,5X100	1	2749140000
Marking tags		
DEK 5/5 PLUS MC NE WS	1000	1854490000
DEK 5/5 MM WS	800	2007110000
WS 8/5 MM WS	800	2007150000
WS 10/5 M PLUS MC NE WS	600	2003770000
SNAPMARK I	50	1805880000

Type	Qty.	Order No.
ZQV 4N/2	32 A 60	1527930000
ZQV 4N/10	32 A 20	1528090000
End plate		
AEP 2T 4	20	2540000000
AEP 2T 4 BL	20	2540010000
End bracket		
AEB 35 SC/1	50	1991920000
AEB 35 SCL/1 VO	20	2661280000
Test adapter		
ATPG 1.5-10 L	0.2 A 50	1991890000
ATPG 4 MHR	0.2 A 50	1991860000
Test plug		
PS 2.0 MC	20	0310000000
Screwdriver		
SDIL 0,6X3,5X100	1	2749140000
Marking tags		
DEK 5/5 PLUS MC NE WS	1000	1854490000
DEK 5/5 MM WS	800	2007110000
WS 8/5 MM WS	800	2007150000
WS 10/5 M PLUS MC NE WS	600	2003770000
SNAPMARK I	50	1805880000

For detailed information on other accessories and application in the online catalogue

A2T 4 FT-PE

4 mm²

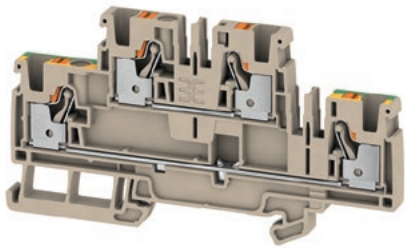

6.1 x 100 x 53.5
32 / 6
0.14...6

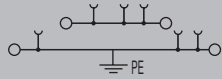

IEC 60947-7-1, IEC 60947-7-2

IEC	UL	CSA	EN 60079-7
800	600		550
32	30		25
4	AWG 26...10		4 mm ²
8 kV / 3			
A4 / V-0			

© C, CE, SA, UL, VDE, TÜV, PC, #42

TUEV16ATEX7909U

Rated connection

0.5...4 / 0.5...6
0.5...6 / 0.5...4
12 / 0.6 x 3.5 mm

A2T 4 N-FT

4 mm²

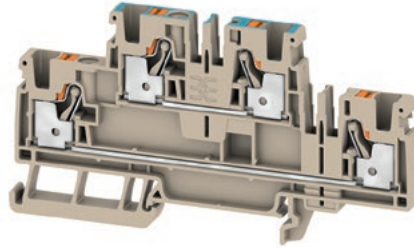

6.1 x 100 x 53.5
32 / 6
0.14...6

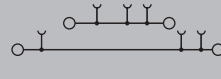

IEC 60947-7-1

IEC	UL	CSA	EN 60079-7
800			
32			
4			
8 kV / 3			
A4 / V-0			

© C, CE

Rated connection

0.5...4 / 0.5...6
0.5...6 / 0.5...4
12 / 0.6 x 3.5 mm

Type	Qty.	Order No.
A2T 4 FT-PE	50	2539980000

Type	Qty.	Order No.
A2T 4 N-FT	50	2724450000

Type	Qty.	Order No.
ZQV 4N/2	32 A 60	1527930000
ZQV 4N/10	32 A 20	1528090000
AEP 2T 4	20	2540000000
AEP 2T 4 BL	20	2540010000
AEB 35 SC/1	50	1991920000
AEB 35 SCL/1 VO	20	2661280000
ATPG 1.5-10 L	0.2 A 50	1991890000
ATPG 4 MHR	0.2 A 50	1991860000
PS 2.0 MC	20	0310000000
SDIL 0,6X3,5X100	1	2749140000
DEK 5/5 PLUS MC NE WS	1000	1854490000
DEK 5/5 MM WS	800	2007110000
WS 8/5 MM WS	800	2007150000
WS 10/5 M PLUS MC NE WS	600	2003770000
SNAPMARK I	50	1805880000

Type	Qty.	Order No.
ZQV 4N/2	32 A 60	1527930000
ZQV 4N/10	32 A 20	1528090000
AEP 2T 4	20	2540000000
AEP 2T 4 BL	20	2540010000
AEB 35 SC/1	50	1991920000
AEB 35 SCL/1 VO	20	2661280000
ATPG 1.5-10 L	0.2 A 50	1991890000
ATPG 4 MHR	0.2 A 50	1991860000
PS 2.0 MC	20	0310000000
SDIL 0,6X3,5X100	1	2749140000
DEK 5/5 PLUS MC NE WS	1000	1854490000
DEK 5/5 MM WS	800	2007110000
WS 8/5 MM WS	800	2007150000
WS 10/5 M PLUS MC NE WS	600	2003770000
SNAPMARK I	50	1805880000



Spring connection with PUSH IN technology (A-Series)

Feed-through terminal blocks



A3T 1.5

1.5 mm²

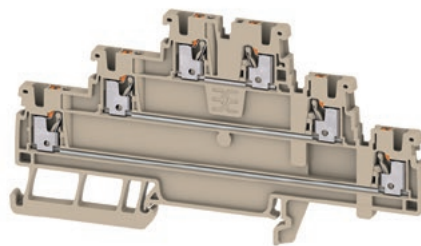

A3T 1.5 VL

1.5 mm²

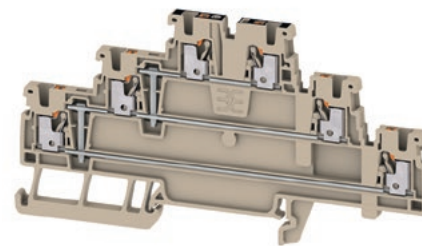

Width/Height/Depth	mm
max. current / max. cond. cross-section	A/mm ²
Max. clamping range	mm ²

3.5 x 106.5 x 53	
15 / 1.5	
0.14...1.5	

3.5 x 106.5 x 53	
15 / 1.5	
0.14...1.5	

Technical data

Rated data	
Rated voltage	V
Rated current	A
for wire cross-section	mm ²
Rated impulse withstand voltage / Pollution severity	
Gauge to IEC 60947-1 / UL 94 flammability rating	
Approvals	
Clamped conductors (H05V/H07V)	
Solid / Stranded	mm ²
Flexible / Flexible with ferrule	mm ²
Stripping length / Blade size	mm/-
Note	

IEC 60947-7-1			
IEC	UL	CSA	EN 60079-7
500			
15			
1.5			
	6 kV / 3		
	A1 / V-0		
CE			
Rated connection			
0.5...1.5 / 0.5...1.5			
0.5...1.5 / 0.5...1.5			
8 / 0.4 x 2.0 mm			
Note			

IEC 60947-7-1			
IEC	UL	CSA	EN 60079-7
500			
15			
1.5			
	6 kV / 3		
	A1 / V-0		
CE			
Rated connection			
0.5...1.5 / 0.5...1.5			
0.5...1.5 / 0.5...1.5			
8 / 0.4 x 2.0 mm			
Note			

Ordering data

Version	
	dark beige
	Blue
Note	

Type	Qty.	Order No.
A3T 1.5	50	2816930000
A3T 1.5 BL	50	2816940000
Note		

Type	Qty.	Order No.
A3T 1.5 VL	50	2817980000
Note		

Accessories

Plug-in cross-connection	
	2-pole
	10-pole
	2-pole
	10-pole
	2-pole
	10-pole
End plate	
	dark beige
	blue
End bracket	
	dark beige, screwable
	dark beige, direct mounting
Test adapter	
	1-pole
	stackable
	3-pole
	5-pole
Test plug	
Screwdriver	
	Standard
Marking tags	

Type	Qty.	Order No.
ZQV 1.5N/2	17.5 A 60	1985410000
ZQV 1.5N/10	17.5 A 20	1985580000
AEP 3T 1.5	20	2816950000
AEB 35 SC/1	50	1991920000
AEB 35 SCL/1 V0	20	2661280000
ATPG 1.5-10 L	0.2 A 50	1991890000
ATPG 1.5 MHR	0.2 A 50	1991880000
PS 2.0 MC	20	0310000000
SDS 0.4X2.0X60	1	2749260000
WS 10/3.5 PLUS MC NE WS	960	2003760000
DEK 5/3.5 MM WS	1000	2007100000
DEK 5/3.5 PLUS MC NE WS	1600	2003750000
SNAPMARK 1.5	40	2682080000
Note		

Type	Qty.	Order No.
ZQV 1.5N/2	17.5 A 60	1985410000
ZQV 1.5N/10	17.5 A 20	1985580000
AEP 3T 1.5	20	2816950000
AEB 35 SC/1	50	1991920000
AEB 35 SCL/1 V0	20	2661280000
ATPG 1.5-10 L	0.2 A 50	1991890000
ATPG 1.5 MHR	0.2 A 50	1991880000
PS 2.0 MC	20	0310000000
SDS 0.4X2.0X60	1	2749260000
WS 10/3.5 PLUS MC NE WS	960	2003760000
DEK 5/3.5 MM WS	1000	2007100000
DEK 5/3.5 PLUS MC NE WS	1600	2003750000
SNAPMARK 1.5	40	2682080000
Note		

For detailed information on other accessories and application in the online catalogue

A3T 1.5 FT-FT-PE

1.5 mm²

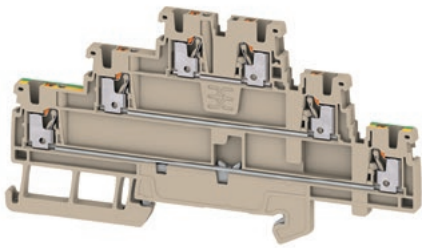

3.5 x 106.5 x 53
15 / 1.5
0.14...1.5

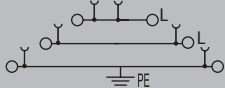

IEC 60947-7-1 (-7-2)

IEC	UL	CSA	EN 60079-7
500			
15			
1.5			
		6 kV / 3	
		A1 / V-0	

CE

Rated connection

0.5...1.5 / 0.5...1.5

0.5...1.5 / 0.5...1.5

8 / 0.4 x 2.0 mm

Type	Qty.	Order No.
A3T 1.5 FT-FT-PE	50	2817990000

Type	Qty.	Order No.
ZQV 1.5N/2	17.5 A 60	1985410000
ZQV 1.5N/10	17.5 A 20	1985580000
AEP 3T 1.5	20	2816950000
AEB 35 SC/1	50	1991920000
AEB 35 SCL/1 VO	20	2661280000
ATPG 1.5-10 L	0.2 A 50	1991890000
ATPG 1.5 MI-R	0.2 A 50	1991880000
PS 2.0 MC	20	0310000000
SDS 0.4X2.0X60	1	2749260000
WS 10/3.5 PLUS MC NE WS	960	2003760000
DEK 5/3.5 MM WS	1000	2007100000
DEK 5/3.5 PLUS MC NE WS	1600	2003750000
SNAPMARK 1.5	40	2682080000



Spring connection with PUSH IN technology (A-Series)

Feed-through terminal blocks

Universal range

A

A3T 2.5 2.5 mm²

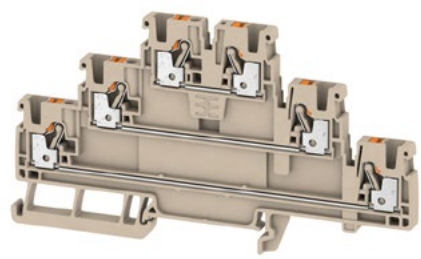

A3T 2.5 VL 2.5 mm²

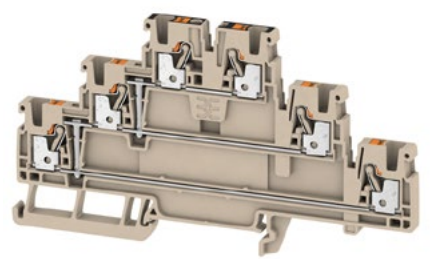

Width/Height/Depth	mm
max. current / max. cond. cross-section	A/mm ²
Max. clamping range	mm ²

5.1 x 116 x 64.5	
22 / 4	
0.14...4	

5.1 x 116 x 64.5	
24 / 4	
0.14...4	

Technical data

Rated data	
Rated voltage	V
Rated current	A
for wire cross-section	mm ²
Rated impulse withstand voltage / Pollution severity	
Gauge to IEC 60947-1 / UL 94 flammability rating	
Approvals	
Clamped conductors (H05V/H07V)	
Solid / Stranded	mm ²
Flexible / Flexible with ferrule	mm ²
Stripping length / Blade size	mm/-
Note	

Ex eb II
C Gb II 2 G D

DIN EN 60947-1

IEC	UL	CSA	EN 60079-7
800	300	300	550
22	20	20	19
2.5	AWG 28...12	AWG 28...12	2.5 mm ²
8 kV / 3			
A3 / V-0			
TUEV16ATEX7909U			
Rated connection			
0.5...2.5 / 0.5...4			
0.5...4 / 0.5...2.5			
10 / 0.6 x 3.5 mm			

Ex eb II
C Gb II 2 G D

DIN EN 60947-1

IEC	UL	CSA	EN 60079-7
800	300	300	550
24	20	20	19
2.5	AWG 28...12	AWG 28...12	2.5 mm ²
8 kV / 3			
A3 / V-0			
TUEV16ATEX7909U			
Rated connection			
0.5...2.5 / 0.5...4			
0.5...4 / 0.5...2.5			
10 / 0.6 x 3.5 mm			

Ordering data

Version	
	dark beige
	Blue
Note	

Type	Qty.	Order No.
A3T 2.5	50	2428510000
A3T 2.5 BL	50	2428520000

Type	Qty.	Order No.
A3T 2.5 VL	25	2428540000
A3T 2.5 VL BL	25	2428550000

Accessories

Plug-in cross-connection	
	2-pole
	10-pole
	2-pole
	10-pole
	2-pole
	10-pole
End plate	
	dark beige
	blue
End bracket	
	dark beige, screwable
	dark beige, direct mounting
Test adapter	
	1-pole
	stackable
	3-pole
	5-pole
Test plug	
Screwdriver	
	Standard
Marking tags	

Type	Qty.	Order No.
ZQV 2.5N/2	24 A 60	1527540000
ZQV 2.5N/10	24 A 20	1527690000
End plate		
AEP 3T 2.5	20	2428560000
AEP 3T 2.5 BL	20	2428860000
End bracket		
AEB 35 SC/1	50	1991920000
AEB 35 SCL/1 V0	20	2661280000
Test adapter		
ATPG 1.5-10 L	0.2 A 50	1991890000
ATPG 2.5 MHR	0.2 A 50	1991960000
ATPG 2.5/3	0.2 A 25	2041190000
ATPG 2.5/5	0.2 A 25	2041180000
Test plug		
PS 2.0 MC	20	0310000000
Screwdriver		
SDIL 0,6X3,5X100	1	2749140000
Marking tags		
DEK 5/5 PLUS MC NE WS	1000	1854490000
DEK 5/5 MM WS	800	2007110000
WS 8/5 MM WS	800	2007150000
WS 10/5 M PLUS MC NE WS	600	2003770000
SNAPMARK I	50	1805880000

Type	Qty.	Order No.
ZQV 2.5N/2	24 A 60	1527540000
ZQV 2.5N/10	24 A 20	1527690000
End plate		
AEP 3T 2.5	20	2428560000
AEP 3T 2.5 BL	20	2428860000
End bracket		
AEB 35 SC/1	50	1991920000
AEB 35 SCL/1 V0	20	2661280000
Test adapter		
ATPG 1.5-10 L	0.2 A 50	1991890000
ATPG 2.5 MHR	0.2 A 50	1991960000
ATPG 2.5/3	0.2 A 25	2041190000
ATPG 2.5/5	0.2 A 25	2041180000
Test plug		
PS 2.0 MC	20	0310000000
Screwdriver		
SDIL 0,6X3,5X100	1	2749140000
Marking tags		
DEK 5/5 PLUS MC NE WS	1000	1854490000
DEK 5/5 MM WS	800	2007110000
WS 8/5 MM WS	800	2007150000
WS 10/5 M PLUS MC NE WS	600	2003770000
SNAPMARK I	50	1805880000

For detailed information on other accessories and application in the online catalogue

A3T 2.5 FT-FT-PE

2.5 mm²

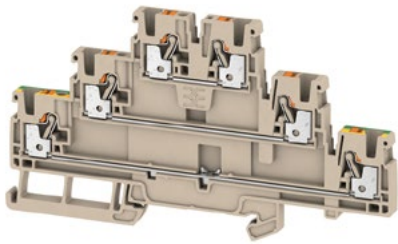

5.1 x 116 x 64.5
24 / 4
0.14...4

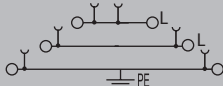

Ex eb II
C Gb II 2 G D

DIN EN 60947-7-1, DIN EN 60947-7-2

IEC	UL	CSA	EN 60079-7
800	300	300	550
24	20	20	19
2.5	AWG 28...12	AWG 28...12	2.5 mm ²

8 kV / 3

A3 / V-0

TUEV16ATEX7909U

Rated connection

0.5...2.5 / 0.5...4

0.5...4 / 0.5...2.5

10 / 0.6 x 3.5 mm

A3T 2.5 N-FT-PE

2.5 mm²

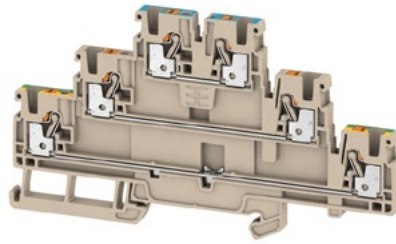

5.1 x 116 x 64.5
24 / 4
0.14...4

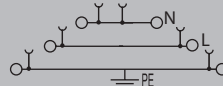

Ex eb II
C Gb II 2 G D

DIN EN 60947-7-1, DIN EN 60947-7-2

IEC	UL	CSA	EN 60079-7
800	300	300	550
24	20	20	19
2.5	AWG 28...12	AWG 28...12	2.5 mm ²

8 kV / 3

A3 / V-0

TUEV16ATEX7909U

Rated connection

0.5...2.5 / 0.5...4

0.5...4 / 0.5...2.5

10 / 0.6 x 3.5 mm

Type	Qty.	Order No.
A3T 2.5 FT-FT-PE	50	2428530000

Type	Qty.	Order No.
A3T 2.5 N-FT-PE	50	2428840000

Type	Qty.	Order No.
ZQV 2.5N/2	24 A 60	1527540000
ZQV 2.5N/10	24 A 20	1527690000
AEP 3T 2.5	20	2428560000
AEP 3T 2.5 BL	20	2428860000
AEB 35 SC/1	50	1991920000
AEB 35 SCL/1 VO	20	2661280000
ATPG 1.5-10 L	0.2 A 50	1991890000
ATPG 2.5 MI-R	0.2 A 50	1991960000
ATPG 2.5/3	0.2 A 25	2041190000
ATPG 2.5/5	0.2 A 25	2041180000
PS 2.0 MC	20	0310000000
SDIL 0,6X3,5X100	1	2749140000
DEK 5/5 PLUS MC NE WS	1000	1854490000
DEK 5/5 MM WS	800	2007110000
WS 8/5 MM WS	800	2007150000
WS 10/5 M PLUS MC NE WS	600	2003770000
SNAPMARK I	50	1805880000

Type	Qty.	Order No.
ZQV 2.5N/2	24 A 60	1527540000
ZQV 2.5N/10	24 A 20	1527690000
AEP 3T 2.5	20	2428560000
AEP 3T 2.5 BL	20	2428860000
AEB 35 SC/1	50	1991920000
AEB 35 SCL/1 VO	20	2661280000
ATPG 1.5-10 L	0.2 A 50	1991890000
ATPG 2.5 MI-R	0.2 A 50	1991960000
ATPG 2.5/3	0.2 A 25	2041190000
ATPG 2.5/5	0.2 A 25	2041180000
PS 2.0 MC	20	0310000000
SDIL 0,6X3,5X100	1	2749140000
DEK 5/5 PLUS MC NE WS	1000	1854490000
DEK 5/5 MM WS	800	2007110000
WS 8/5 MM WS	800	2007150000
WS 10/5 M PLUS MC NE WS	600	2003770000
SNAPMARK I	50	1805880000



Spring connection with PUSH IN technology (A-Series)

Feed-through terminal blocks

Universal range

A

AMC 2.5

2.5 mm²



AMC 2.5 800 V

2.5 mm²



Width/Height/Depth	mm
max. current / max. cond. cross-section	A/mm ²
Max. clamping range	mm ²

5.1 x 107.5 x 88
22 / 2.5
0.14...2.5

6.1 x 107.5 x 88
22 / 2.5
0.14...2.5

Technical data

Rated data	
Rated voltage	V
Rated current	A
for wire cross-section	mm ²
Rated impulse withstand voltage / Pollution severity	
Gauge to IEC 60947-1 / UL 94 flammability rating	
Approvals	
Clamped conductors (H05V/H07V)	
Solid / Stranded	mm ²
Flexible / Flexible with ferrule	mm ²
Stripping length / Blade size	mm/-
Note	

DIN EN 60947-7-1, DIN EN 60947-7-2 C Gb Ex eb II II 2 G D

IEC	UL	CSA	EN 60079-7
690	150	150	440
22	20	20	19
2.5	AWG 28...12	AWG 28...12	2.5 mm ²
8 kV / 3			
A3 / V-0			
TUEV16ATEX7909U			
Rated connection			
0.5...2.5 / 0.5...4			
0.5...4 / 0.5...2.5			
10 / 0.6 x 3.5 mm			

DIN EN 60947-7-1, DIN EN 60947-7-2 C Gb Ex eb II II 2 G D

IEC	UL	CSA	EN 60079-7
800	600	600	440
22	20	20	19
2.5	AWG 28...12	AWG 28...12	2.5 mm ²
8 kV / 3			
A3 / V-0			
TUEV16ATEX7909U			
Rated connection			
0.5...2.5 / 0.5...4			
0.5...4 / 0.5...2.5			
10 / 0.6 x 3.5 mm			

Ordering data

Version	dark beige
Note	

Type	Qty.	Order No.
AMC 2.5	50	2434340000

Type	Qty.	Order No.
AMC 2.5 800V	50	2434370000

Accessories

Plug-in cross-connection	
	2-pole
	10-pole
Vertical jumpers	
	1-pole
End plate	dark beige
End bracket	dark beige, screwable dark beige, direct mounting
Test plug	
Screwdriver	Standard
Marking tags	

Type	Qty.	Order No.
ZQV 2.5N/2	24 A 60	1527540000
ZQV 2.5N/10	24 A 20	1527690000
ZVQ 2.5/1.5	24 A 50	1720700000
AEP MC 2.5	25	2433820000
AEB 35 SC/1	50	1991920000
AEB 35 SCL/1 VO	20	2661280000
PS 2.0 MC	20	0310000000
SDIL 0,6X3,5X100	1	2749140000
DEK 5/5 PLUS MC NE WS	1000	1854490000
DEK 5/5 MM WS	800	2007110000
WS 8/5 MM WS	800	2007150000
WS 10/5 M PLUS MC NE WS	600	2003770000
SNAPMARK I	50	1805880000

Type	Qty.	Order No.
ZVQ 2.5/1.5	24 A 50	1720700000
AEB 35 SC/1	50	1991920000
AEB 35 SCL/1 VO	20	2661280000
PS 2.0 MC	20	0310000000
SDIL 0,6X3,5X100	1	2749140000
DEK 5/5 PLUS MC NE WS	1000	1854490000
DEK 5/5 MM WS	800	2007110000
WS 8/5 MM WS	800	2007150000
WS 10/5 M PLUS MC NE WS	600	2003770000
SNAPMARK I	50	1805880000

For detailed information on other accessories and application in the online catalogue



Spring connection with PUSH IN technology (A-Series)
PE terminal blocks

Universal range

A

A2C 1.5 PE

1.5 mm²

A3C 1.5 PE

1.5 mm²

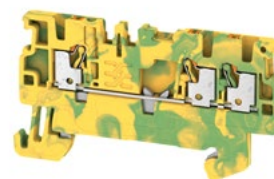

Width/Height/Depth	mm
max. current / max. cond. cross-section	-/mm ²
Max. clamping range	mm ²

3.5 x 55 x 33.5	
/ 1.5	
0.14...1.5	

3.5 x 61.5 x 33.5	
/ 1.5	
0.14...1.5	

Technical data

Rated data	
for wire cross-section	mm ²
Rated voltage to adjoining terminal	V
Rated impulse withstand voltage to adjacent terminal	-
Rated short-time current	
Pollution severity	
Gauge to IEC 60947-1 / UL 94 flammability rating	
Approvals	
Clamped conductors (H05V/H07V)	
Solid / Stranded	mm ²
Flexible / Flexible with ferrule	mm ²
Stripping length / Blade size	mm/-

Ex eb II C GbII
2 G D

IEC 60947-7-2

IEC	UL	CSA	EN 60079-7
1.5	AWG 26...14	AWG 26...14	1.5 mm ²
500			
180 A (1.5 mm ²)			
3			
A1 / V-0			

Rated connection
0.5...1.5 / 0.5...1.5
0.5...1.5 / 0.5...1
8 / 0.4 x 2.0 mm

Ex eb II C GbII
2 G D

IEC 60947-7-2

IEC	UL	CSA	EN 60079-7
1.5	AWG 26...14	AWG 26...14	1.5 mm ²
500			
180 A (1.5 mm ²)			
3			
A1 / V-0			

Rated connection
0.5...1.5 / 0.5...1.5
0.5...1.5 / 0.5...1
8 / 0.4 x 2.0 mm

Note

Ordering data

Version	Green/yellow
Note	

Type	Qty.	Order No.
A2C 1.5 PE	50	1552680000

Type	Qty.	Order No.
A3C 1.5 PE	50	1552670000

Accessories

End plate	dark beige Blue
End bracket	dark beige, screwable dark beige, direct mounting
Test adapter	1-pole stackable 3-pole 5-pole
Test plug	
Screwdriver	Standard
Marking tags	

Type	Qty.	Order No.
AEP 2C 1.5	50	1552600000
AEB 35 SC/1	50	1991920000
AEB 35 SCL/1 V0	20	2661280000
ATPG 1.5-10 L	0.2 A 50	1991890000
ATPG 1.5 M-R	0.2 A 50	1991880000
PS 2.0 MC	20	0310000000
SDS 0.4X2.0X60	1	2749260000
WS 10/3.5 PLUS MC NE WS	960	2003760000
DEK 5/3.5 MM WS	1000	2007100000
DEK 5/3.5 PLUS MC NE WS	1600	2003750000

Type	Qty.	Order No.
AEP 3C 1.5	50	1552620000
AEB 35 SC/1	50	1991920000
AEB 35 SCL/1 V0	20	2661280000
ATPG 1.5-10 L	0.2 A 50	1991890000
ATPG 1.5 M-R	0.2 A 50	1991880000
PS 2.0 MC	20	0310000000
SDS 0.4X2.0X60	1	2749260000
WS 10/3.5 PLUS MC NE WS	960	2003760000
DEK 5/3.5 MM WS	1000	2007100000
DEK 5/3.5 PLUS MC NE WS	1600	2003750000

For detailed information on other accessories and application in the online catalogue

A4C 1.5 PE

1.5 mm²

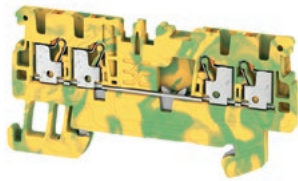

3.5 x 67.5 x 33.5
/ 1.5
0.14...1.5



Ex eb II C GbII
2 G D

IEC 60947-7-2

IEC	UL	CSA	EN 60079-7
1.5	AWG 26...14	AWG 26...14	1.5 mm ²
500			

180 A (1.5 mm²)

3

A1 / V-0

Rated connection

0.5...1.5 / 0.5...1.5

0.5...1.5 / 0.5...1

8 / 0.4 x 2.0 mm

Type	Qty.	Order No.
A4C 1.5 PE	50	1552660000

A2C 2.5 PE

2.5 mm²

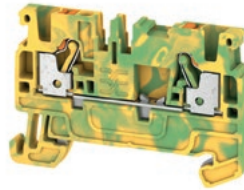

5.1 x 55 x 36.5
/ 4
0.14...4



Ex eb II C GbII
2 G D

IEC 60947-7-2

IEC	UL	CSA	EN 60079-7
2.5	AWG 28...12	AWG 28...12	2.5 mm ²
800			

300 A (2.5 mm²)

3

A3 / V-0

Rated connection

0.5...2.5 / 0.5...4

0.5...4 / 0.5...2.5

10 / 0.6 x 3.5 mm

Type	Qty.	Order No.
A2C 2.5 PE	50	1521680000

AL2C 2.5 PE

2.5 mm²



5.1 x 57 x 36.5
/ 2.5
0.14...2.5

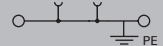

IEC 60947-7-2

IEC	UL	CSA	EN 60079-7
2.5			
800			

300 A (2.5 mm²)

3

A3 / V-0

CE

Rated connection

0.5...2.5 / 0.5...2.5

0.5...2.5 / 0.5...2.5

10 / 0.6 x 3.5 mm

Type	Qty.	Order No.
AL2C 2.5 PE	50	2847590000

Type	Qty.	Order No.
AEP 4C 1.5	50	1552640000

AEB 35 SC/1	50	1991920000
AEB 35 SCL/1 V0	20	2661280000

ATPG 1.5-10 L	0.2 A	50	1991890000
ATPG 1.5 MI-R	0.2 A	50	1991880000

PS 2.0 MC	20	0310000000
-----------	----	------------

SDS 0.4X2.0X60	1	2749260000
----------------	---	------------

WS 10/3.5 PLUS MC NE WS	960	2003760000
DEK 5/3.5 MM WS	1000	2007100000

DEK 5/3.5 PLUS MC NE WS	1600	2003750000
-------------------------	------	------------

Type	Qty.	Order No.
AEP 2C 2.5	50	1514400000

AEB 35 SC/1	50	1991920000
AEB 35 SCL/1 V0	20	2661280000

ATPG 1.5-10 L	0.2 A	50	1991890000
ATPG 2.5 MI-R	0.2 A	50	1991960000
ATPG 2.5/3	0.2 A	25	2041190000
ATPG 2.5/5	0.2 A	25	2041180000

PS 2.0 MC	20	0310000000
-----------	----	------------

SDIL 0,6X3,5X100	1	2749140000
------------------	---	------------

DEK 5/5 PLUS MC NE WS	1000	1854490000
DEK 5/5 MM WS	800	2007110000
WS 8/5 MM WS	800	2007150000

WS 10/5 M PLUS MC NE WS	600	2003770000
-------------------------	-----	------------

Type	Qty.	Order No.
ALEP 2C 2.5	20	2871750000

AEB 35 SC/1	50	1991920000
AEB 35 SCL/1 V0	20	2661280000

ATPG 1.5-10 L	0.2 A	50	1991890000
ATPG 2.5 MI-R	0.2 A	50	1991960000
ATPG 2.5/3	0.2 A	25	2041190000
ATPG 2.5/5	0.2 A	25	2041180000

PS 2.0 MC	20	0310000000
-----------	----	------------

SDIL 0,6X3,5X100	1	2749140000
------------------	---	------------

DEK 5/5 PLUS MC NE WS	1000	1854490000
DEK 5/5 MM WS	800	2007110000
WS 8/5 MM WS	800	2007150000

WS 10/5 M PLUS MC NE WS	600	2003770000
-------------------------	-----	------------



Spring connection with PUSH IN technology (A-Series)
PE terminal blocks

A3C 2.5 PE

2.5 mm²

AL3C 2.5 PE

2.5 mm²

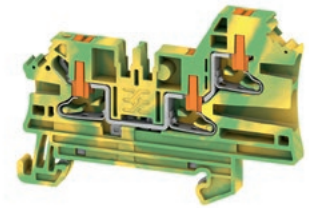
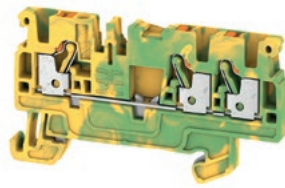

Width/Height/Depth	mm
max. current / max. cond. cross-section	-/mm ²
Max. clamping range	mm ²

5.1 x 66.5 x 36.5
/ 4
0.14...4

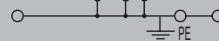

5.1 x 68 x 48
/ 2.5
0.14...2.5

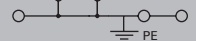

Technical data

Rated data	
for wire cross-section	mm ²
Rated voltage to adjoining terminal	V
Rated impulse withstand voltage to adjacent terminal	-
Rated short-time current	
Pollution severity	
Gauge to IEC 60947-1 / UL 94 flammability rating	
Approvals	
Clamped conductors (H05V/H07V)	
Solid / Stranded	mm ²
Flexible / Flexible with ferrule	mm ²
Stripping length / Blade size	mm/-

IEC 60947-7-2			
Ex eb II C GbII 2 G D			
IEC	UL	CSA	EN 60079-7
2.5	AWG 28...12	AWG 28...12	2.5 mm ²
800			
300 A (2.5 mm ²)			
3			
A3 / V-0			
Rated connection			
0.5...2.5 / 0.5...4			
0.5...4 / 0.5...2.5			
10 / 0.6 x 3.5 mm			

IEC 60947-7-2			
IEC	UL	CSA	EN 60079-7
2.5			
800			
300 A (2.5 mm ²)			
3			
A3 / V-0			
CE			
Rated connection			
0.5...2.5 / 0.5...2.5			
0.5...2.5 / 0.5...2.5			
10 / 0.6 x 3.5 mm			

Note

Ordering data

Version	Green/yellow
Note	

Type	Qty.	Order No.
A3C 2.5 PE	50	1521670000

Type	Qty.	Order No.
AL3C 2.5 PE	50	2847600000

Accessories

End plate	dark beige Blue
End bracket	dark beige, screwable dark beige, direct mounting
Test adapter	1-pole stackable 3-pole 5-pole
Test plug	
Screwdriver	Standard
Marking tags	

Type	Qty.	Order No.
AEP 3C 2.5	50	1521510000
AEB 35 SC/1	50	1991920000
AEB 35 SCL/1 V0	20	2661280000
ATPG 1.5-10 L	0.2 A 50	1991890000
ATPG 2.5 MI-R	0.2 A 50	1991960000
ATPG 2.5/3	0.2 A 25	2041190000
ATPG 2.5/5	0.2 A 25	2041180000
PS 2.0 MC	20	0310000000
SDIL 0,6X3,5X100	1	2749140000
DEK 5/5 PLUS MC NE WS	1000	1854490000
DEK 5/5 MM WS	800	2007110000
WS 8/5 MM WS	800	2007150000
WS 10/5 M PLUS MC NE WS	600	2003770000

Type	Qty.	Order No.
ALEP 3C 2.5	20	2871770000
AEB 35 SC/1	50	1991920000
AEB 35 SCL/1 V0	20	2661280000
ATPG 1.5-10 L	0.2 A 50	1991890000
ATPG 2.5 MI-R	0.2 A 50	1991960000
ATPG 2.5/3	0.2 A 25	2041190000
ATPG 2.5/5	0.2 A 25	2041180000
PS 2.0 MC	20	0310000000
SDIL 0,6X3,5X100	1	2749140000
DEK 5/5 PLUS MC NE WS	1000	1854490000
DEK 5/5 MM WS	800	2007110000
WS 8/5 MM WS	800	2007150000
WS 10/5 M PLUS MC NE WS	600	2003770000

For detailed information on other accessories and application in the online catalogue

A4C 2.5 PE

2.5 mm²

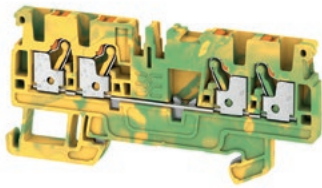

5.1 x 77.5 x 36.5
/ 4
0.14...4



Ex eb II C GbII
2 G D

IEC 60947-7-2

IEC	UL	CSA	EN 60079-7
2.5	AWG 28...12	AWG 28...12	2.5 mm ²
800			

300 A (2.5 mm²)
3
A3 / V-0



Rated connection

0.5...2.5 / 0.5...4
0.5...4 / 0.5...2.5
10 / 0.6 x 3.5 mm

AL4C 2.5 PE

2.5 mm²

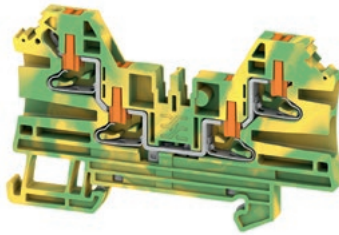

5.1 x 79.5 x 48
/ 2.5
0.14...2.5

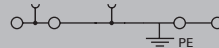

IEC 60947-7-2

IEC	UL	CSA	EN 60079-7
2.5			
800			

300 A (2.5 mm²)
3
A3 / V-0

CE

Rated connection

0.5...2.5 / 0.5...2.5
0.5...2.5 / 0.5...2.5
10 / 0.6 x 3.5 mm

A2C 4 PE

4 mm²



6.1 x 60 x 39.5
/ 6
0.14...6

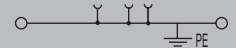

Ex eb II C GbII
2 G D

IEC 60947-7-2

IEC	UL	CSA	EN 60079-7
4	AWG 28...10	AWG 26...10	4 mm ²
800			

480 A (4 mm²)
3
A4 / V-0



Rated connection

0.5...4 / 0.5...6
0.5...6 / 0.5...4
12 / 0.6 x 3.5 mm

Type	Qty.	Order No.
A4C 2.5 PE	50	1521540000

Type	Qty.	Order No.
AL4C 2.5 PE	50	2847610000

Type	Qty.	Order No.
A2C 4 PE	50	2051360000

Type	Qty.	Order No.	
AEP 4C 2.5	50	1521530000	
AEB 35 SC/1	50	1991920000	
AEB 35 SCL/1 V0	20	2661280000	
ATPG 1.5-10 L	0.2 A	50	1991890000
ATPG 2.5 MI-R	0.2 A	50	1991960000
ATPG 2.5/3	0.2 A	25	2041190000
ATPG 2.5/5	0.2 A	25	2041180000
PS 2.0 MC	20	0310000000	
SDIL 0,6X3,5X100	1	2749140000	
DEK 5/5 PLUS MC NE WS	1000	1854490000	
DEK 5/5 MM WS	800	2007110000	
WS 8/5 MM WS	800	2007150000	
WS 10/5 M PLUS MC NE WS	600	2003770000	

Type	Qty.	Order No.	
ALEP 4C 2.5	20	2871790000	
AEB 35 SC/1	50	1991920000	
AEB 35 SCL/1 V0	20	2661280000	
ATPG 1.5-10 L	0.2 A	50	1991890000
ATPG 2.5 MI-R	0.2 A	50	1991960000
ATPG 2.5/3	0.2 A	25	2041190000
ATPG 2.5/5	0.2 A	25	2041180000
PS 2.0 MC	20	0310000000	
SDIL 0,6X3,5X100	1	2749140000	
DEK 5/5 PLUS MC NE WS	1000	1854490000	
DEK 5/5 MM WS	800	2007110000	
WS 8/5 MM WS	800	2007150000	
WS 10/5 M PLUS MC NE WS	600	2003770000	

Type	Qty.	Order No.	
AEP 2C 4	50	2051680000	
AEB 35 SC/1	50	1991920000	
AEB 35 SCL/1 V0	20	2661280000	
ATPG 1.5-10 L	0.2 A	50	1991890000
ATPG 4 MI-R	0.2 A	50	1991860000
PS 2.0 MC	20	0310000000	
SDIL 0,6X3,5X100	1	2749140000	
WS 10/6 M PLUS MC NE WS	600	2003780000	
DEK 5/6 MM WS	600	2007120000	
WS 8/6 MM WS	600	2007160000	
DEK 5/6 PLUS MC NE WS	1000	1011320000	



Spring connection with PUSH IN technology (A-Series)
PE terminal blocks

AL2C 4 PE

4 mm²

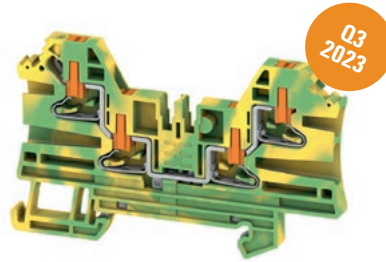

A3C 4 PE

4 mm²

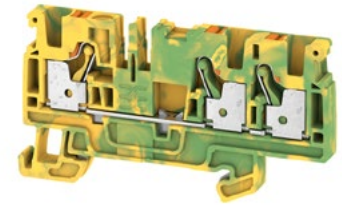

Width/Height/Depth	mm
max. current / max. cond. cross-section	-/mm ²
Max. clamping range	mm ²

6.1 x 60 x 39.5	/ 4	
0.14...4		

6.1 x 74 x 39.5	/ 6	
0.14...6		

Technical data

Rated data	
for wire cross-section	mm ²
Rated voltage to adjoining terminal	V
Rated impulse withstand voltage to adjacent terminal	-
Rated short-time current	
Pollution severity	
Gauge to IEC 60947-1 / UL 94 flammability rating	
Approvals	
Clamped conductors (H05V/H07V)	
Solid / Stranded	mm ²
Flexible / Flexible with ferrule	mm ²
Stripping length / Blade size	mm/-

IEC 60947-7-2			
IEC	UL	CSA	EN 60079-7
4			
800			
	480 A (4 mm ²)		
	3		
	A4 / V-0		
Rated connection			
0.5...4 / 0.5...4			
0.5...4 / 0.5...4			
12 / 0.6 x 3.5 mm			

IEC 60947-7-2			
Ex eb II C GbII 2 G D			
IEC	UL	CSA	EN 60079-7
4	AWG 28...10	AWG 26...10	4 mm ²
800			
	480 A (4 mm ²)		
	3		
	A4 / V-0		
Rated connection			
0.5...4 / 0.5...6			
0.5...6 / 0.5...4			
12 / 0.6 x 3.5 mm			

Note

Ordering data

Version	Green/yellow
Note	

Type	Qty.	Order No.
AL2C 4 PE	50	2847740000

Type	Qty.	Order No.
A3C 4 PE	50	2051410000

Accessories

End plate	dark beige Blue
End bracket	dark beige, screwable dark beige, direct mounting
Test adapter	1-pole stackable 3-pole 5-pole
Test plug	
Screwdriver	Standard
Marking tags	

Type	Qty.	Order No.
ALEP 2C 4		2871810000
AEB 35 SC/1	50	1991920000
AEB 35 SCL/1 V0	20	2661280000
ATPG 1.5-10 L	0.2 A 50	1991890000
ATPG 4 M-R	0.2 A 50	1991860000
PS 2.0 MC	20	0310000000
SDIL 0,6X3,5X100	1	2749140000
WS 10/6 M PLUS MC NE WS	600	2003780000
DEK 5/6 MM WS	600	2007120000
WS 8/6 MM WS	600	2007160000
DEK 5/6 PLUS MC NE WS	1000	1011320000

Type	Qty.	Order No.
AEP 3C 4	20	2051720000
AEB 35 SC/1	50	1991920000
AEB 35 SCL/1 V0	20	2661280000
ATPG 1.5-10 L	0.2 A 50	1991890000
ATPG 2.5 M-R	0.2 A 50	1991960000
PS 2.0 MC	20	0310000000
SDIL 0,6X3,5X100	1	2749140000
DEK 5/5 PLUS MC NE WS	1000	1854490000
DEK 5/5 MM WS	800	2007110000
WS 8/5 MM WS	800	2007150000
WS 10/5 M PLUS MC NE WS	600	2003770000

For detailed information on other accessories and application in the online catalogue

AL3C 4 PE

4 mm²



6.1 x 71.5 x 52.5
/ 4
0.14...4

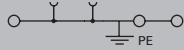

IEC 60947-7-2

IEC	UL	CSA	EN 60079-7
4			
800			
480 A (4 mm ²)			
3			
A4 / V-0			

Rated connection

0.5...4 / 0.5...4
0.5...4 / 0.5...4
12 / 0.6 x 3.5 mm

Type	Qty.	Order No.
AL3C 4 PE	50	2847750000

Type	Qty.	Order No.
ALEP 3C 4		2871830000
AEB 35 SC/1	50	1991920000
AEB 35 SCL/1 V0	20	2661280000
ATPG 1.5-10 L	0.2 A 50	1991890000
ATPG 2.5 MI-R	0.2 A 50	1991960000
PS 2.0 MC	20	0310000000
SDIL 0,6X3,5X100	1	2749140000
DEK 5/5 PLUS MC NE WS	1000	1854490000
DEK 5/5 MM WS	800	2007110000
WS 8/5 MM WS	800	2007150000
WS 10/5 M PLUS MC NE WS	600	2003770000

A4C 4 PE

4 mm²



6.1 x 87.5 x 39.5
/ 6
0.14...6

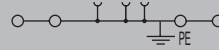

IEC 60947-7-2

IEC	UL	CSA	EN 60079-7
4	AWG 28...10	AWG 26...10	4 mm ²
800			
480 A (4 mm ²)			
3			
A4 / V-0			

Ex eb II C GbII 2 G D Ex

Rated connection

0.5...4 / 0.5...6
0.5...6 / 0.5...4
12 / 0.6 x 3.5 mm

Type	Qty.	Order No.
A4C 4 PE	50	2051560000

Type	Qty.	Order No.
AEP 4C 4	20	2051900000
AEB 35 SC/1	50	1991920000
AEB 35 SCL/1 V0	20	2661280000
ATPG 1.5-10 L	0.2 A 50	1991890000
ATPG 4 MI-R	0.2 A 50	1991860000
PS 2.0 MC	20	0310000000
SDIL 0,6X3,5X100	1	2749140000
WS 10/6 M PLUS MC NE WS	600	2003780000
DEK 5/6 MM WS	600	2007120000
WS 8/6 MM WS	600	2007160000
DEK 5/6 PLUS MC NE WS	1000	1011320000

AL4C 4 PE

4 mm²

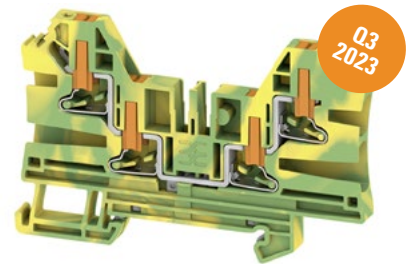

6.1 x 83 x 52.5
/ 4
0.14...4

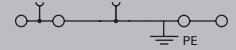

IEC 60947-7-2

IEC	UL	CSA	EN 60079-7
4			
800			
480 A (4 mm ²)			
3			
A4 / V-0			

Rated connection

0.5...4 / 0.5...4
0.5...4 / 0.5...4
12 / 0.6 x 3.5 mm

Type	Qty.	Order No.
AL4C 4 PE	50	2847770000

Type	Qty.	Order No.
ALEP 4C 4		2871850000
ALEP 3C 4 BL		2871840000
AEB 35 SC/1	50	1991920000
AEB 35 SCL/1 V0	20	2661280000
ATPG 1.5-10 L	0.2 A 50	1991890000
ATPG 4 MI-R	0.2 A 50	1991860000
PS 2.0 MC	20	0310000000
SDIL 0,6X3,5X100	1	2749140000
WS 10/6 M PLUS MC NE WS	600	2003780000
DEK 5/6 MM WS	600	2007120000
WS 8/6 MM WS	600	2007160000
DEK 5/6 PLUS MC NE WS	1000	1011320000

Spring connection with PUSH IN technology (A-Series)
PE terminal blocks

Universal range

A

A2C 6 PE

6 mm²

A3C 6 PE

6 mm²

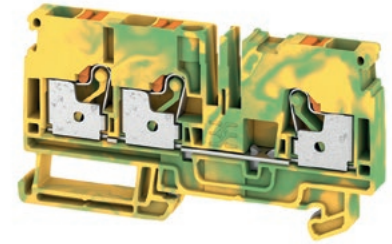

Width/Height/Depth	mm
max. current / max. cond. cross-section	-/mm ²
Max. clamping range	mm ²

8.1 x 66.5 x 45.5	/ 10	
0.34...10		

8.1 x 84.5 x 45.5	/ 10	
0.34...10		

Technical data

Rated data	
for wire cross-section	mm ²
Rated voltage to adjoining terminal	V
Rated impulse withstand voltage to adjacent terminal	-
Rated short-time current	
Pollution severity	
Gauge to IEC 60947-1 / UL 94 flammability rating	
Approvals	
Clamped conductors (H05V/H07V)	
Solid / Stranded	mm ²
Flexible / Flexible with ferrule	mm ²
Stripping length / Blade size	mm/-

Ex eb II C Gbll
2 G D

IEC 60947-7-2

IEC	UL	CSA	EN 60079-7
6	AWG 22...8	AWG 22...8	6 mm ²
800			
720 A (6 mm ²)			
3			
A5 / V-0			

Rated connection			
0.5...6 / 0.5...6			
0.5...10 / 0.5...6			
12 / 0.6 x 3.5 mm			

Ex eb II C Gbll
2 G D

IEC 60947-7-2

IEC	UL	CSA	EN 60079-7
6	AWG 22...8	AWG 22...8	6 mm ²
800			
720 A (6 mm ²)			
3			
A5 / V-0			

Rated connection			
0.5...6 / 0.5...6			
0.5...10 / 0.5...6			
12 / 1.0 x 5.5 mm			

Note

Ordering data

Version	Green/yellow
Note	

Type	Qty.	Order No.
A2C 6 PE	50	1991810000

Type	Qty.	Order No.
A3C 6 PE	50	1991850000

Accessories

End plate	dark beige Blue
End bracket	dark beige, screwable dark beige, direct mounting
Test adapter	1-pole stackable 3-pole 5-pole
Test plug	
Screwdriver	Standard
Marking tags	

Type	Qty.	Order No.
AEP 2C 6	50	1991970000
AEB 35 SC/1	50	1991920000
AEB 35 SCL/1 V0	20	2661280000
ATPG 1.5-10 L	0.2 A 50	1991890000
ATPG 6 M/R	0.2 A 50	1991930000
PS 2.0 MC	20	0310000000
SDIL 1,0X5,5X125	1	2749160000
DEK-A 5/8 MM WS	500	2448860000
DEK 5/8 PLUS MC NE WS	800	1046350000
WS-A 8/8 MM WS	500	2448930000
WS 10/8 PLUS MC NE WS	420	1905950000

Type	Qty.	Order No.
AEP 3C 6	50	1991940000
AEB 35 SC/1	50	1991920000
AEB 35 SCL/1 V0	20	2661280000
ATPG 1.5-10 L	0.2 A 50	1991890000
ATPG 6 M/R	0.2 A 50	1991930000
PS 2.0 MC	20	0310000000
SDIL 1,0X5,5X125	1	2749160000
DEK-A 5/8 MM WS	500	2448860000
DEK 5/8 PLUS MC NE WS	800	1046350000
WS-A 8/8 MM WS	500	2448930000
WS 10/8 PLUS MC NE WS	420	1905950000

For detailed information on other accessories and application in the online catalogue

A4C 6 PE

6 mm²



8.1 x 102 x 45.5
41 / 10
0.34...10

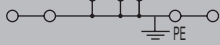

IEC 60947-7-2

IEC	UL	CSA	EN 60079-7
6			
800			
720 A (6 mm ²)			
3			
A5 / V-0			

Rated connection

0.5...6 / 0.5...6
0.5...10 / 0.5...6
12 / 1.0 x 5.5 mm

Type	Qty.	Order No.
A4C 6 PE	50	2881490000

Type	Qty.	Order No.
AEP 4C 6		2876180000
AEB 35 SC/1	50	1991920000
AEB 35 SCL/1 V0	20	2661280000
ATPG 1.5-10 L	0.2 A 50	1991890000
ATPG 6 MI-R	0.2 A 50	1991930000
PS 2.0 MC	20	0310000000
SDIL 1,0X5,5X125	1	2749160000
DEK-A 5/8 MM WS	500	2448860000
DEK 5/8 PLUS MC NE WS	800	1046350000
WS-A 8/8 MM WS	500	2448930000
WS 10/8 PLUS MC NE WS	420	1905950000

A2C 10 PE

10 mm²



10 x 80.5 x 51.5
/ 16
0.5...16

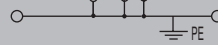

IEC 60947-7-2

IEC	UL	CSA	EN 60079-7
10	AWG 20...6	AWG 20...6	10 mm ²
1000			
1200 A (10 mm ²)			
3			
A6 / V-0			

Ex eb II C GbII 2 G D Ex

Rated connection

0.5...10 / 0.5...10
0.5...10 / 0.5...10
18 / 0.6 x 3.5 mm

Type	Qty.	Order No.
A2C 10 PE	25	2490440000

Type	Qty.	Order No.
AEP 2C 10/16	20	2490380000
AEB 35 SC/1	50	1991920000
AEB 35 SCL/1 V0	20	2661280000
ATPG 1.5-10 L	0.2 A 50	1991890000
PS 2.0 MC	20	0310000000
SDIL 1,0X5,5X125	1	2749160000
DEK 5/5 PLUS MC NE WS	1000	1854490000
DEK 5/8 PLUS MC NE WS	800	1046350000
WS 10/8 PLUS MC NE WS	420	1905950000

A3C 10 PE

10 mm²



10 x 102 x 51.5
/ 16
0.5...16

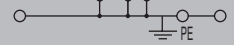

IEC 60947-7-2

IEC	UL	CSA	EN 60079-7
10	AWG 20...6	AWG 20...6	10 mm ²
1000			
1200 A (10 mm ²)			
3			
A6 / V-0			

Ex eb II C GbII 2 G D Ex

Rated connection

0.5...10 / 0.5...10
0.5...10 / 0.5...10
18 / 1.0 x 5.5 mm

Type	Qty.	Order No.
A3C 10 PE	25	2490590000

Type	Qty.	Order No.
AEP 3C 10/16	20	2490530000
AEB 35 SC/1	50	1991920000
AEB 35 SCL/1 V0	20	2661280000
ATPG 1.5-10 L	0.2 A 50	1991890000
PS 2.0 MC	20	0310000000
SDIL 1,0X5,5X125	1	2749160000
DEK 5/5 PLUS MC NE WS	1000	1854490000
DEK 5/8 PLUS MC NE WS	800	1046350000
WS 10/8 PLUS MC NE WS	420	1905950000



Spring connection with PUSH IN technology (A-Series)
PE terminal blocks

A2C 16 PE

16 mm²



A3C 16 PE

16 mm²



Width/Height/Depth	mm
max. current / max. cond. cross-section	-/mm ²
Max. clamping range	mm ²

12 x 80.5 x 51.5	
/ 25	
0.5...25	

12 x 102 x 51.5	
/ 25	
0.5...25	

Technical data

Rated data	
for wire cross-section	mm ²
Rated voltage to adjoining terminal	V
Rated impulse withstand voltage to adjacent terminal	-
Rated short-time current	
Pollution severity	
Gauge to IEC 60947-1 / UL 94 flammability rating	
Approvals	
Clamped conductors (H05V/H07V)	
Solid / Stranded	mm ²
Flexible / Flexible with ferrule	mm ²
Stripping length / Blade size	mm/-

IEC 60947-7-2			
IEC	UL	CSA	EN 60079-7
16	AWG 18...6	AWG 18...6	16 mm ²
1000			
1920 A (16 mm ²)			
3			
A6 / V-0			
Rated connection			
0.5...16 / 10...25			
0.5...25 / 0.5...16			
18 / 1.0 x 5.5 mm			

IEC 60947-7-2			
IEC	UL	CSA	EN 60079-7
16	AWG 18...6	AWG 18...6	16 mm ²
1000			
1920 A (16 mm ²)			
3			
A6 / V-0			
Rated connection			
0.5...16 / 10...25			
0.5...25 / 0.5...16			
18 / 1.0 x 5.5 mm			

Note

Ordering data

Version	
	Green/yellow
Note	

Type	Qty.	Order No.
A2C 16 PE	20	2494010000

Type	Qty.	Order No.
A3C 16 PE	20	2494020000

Accessories

End plate	dark beige Blue
End bracket	dark beige, screwable dark beige, direct mounting
Test adapter	1-pole stackable 3-pole 5-pole
Test plug	
Screwdriver	Standard
Marking tags	

Type	Qty.	Order No.
AEP 2C 10/16	20	2490380000
AEB 35 SC/1	50	1991920000
AEB 35 SCL/1 V0	20	2661280000
ATPG 1.5-10 L	0.2 A 50	1991890000
PS 2.0 MC	20	0310000000
SDIL 1,0X5,5X125	1	2749160000
DEK 5/5 PLUS MC NE WS	1000	1854490000
DEK 5/8 PLUS MC NE WS	800	1046350000
WS-A 8/12 MM WS	300	2619900000
WS 10/8 PLUS MC NE WS	420	1905950000

Type	Qty.	Order No.
AEP 3C 10/16	20	2490530000
AEB 35 SC/1	50	1991920000
AEB 35 SCL/1 V0	20	2661280000
ATPG 1.5-10 L	0.2 A 50	1991890000
PS 2.0 MC	20	0310000000
SDIL 1,0X5,5X125	1	2749160000
DEK 5/5 PLUS MC NE WS	1000	1854490000
DEK 5/8 PLUS MC NE WS	800	1046350000
WS-A 8/12 MM WS	300	2619900000
WS 10/8 PLUS MC NE WS	420	1905950000

For detailed information on other accessories and application in the online catalogue

A2C 35 PE

35 mm²

A2C 50/70 PE

50 mm²

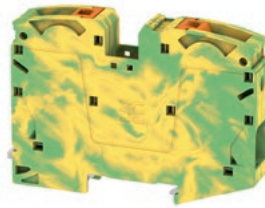

Width/Height/Depth	mm
max. current / max. cond. cross-section	-/mm ²
Max. clamping range	mm ²

16 x 101 x 71.5
/ 35
2.5...35

20 x 101.5 x 80.5
/ 70
10...70

Technical data

Rated data	
for wire cross-section	mm ²
Rated voltage to adjoining terminal	V/V DC
Rated impulse withstand voltage to adjacent terminal	-
Rated short-time current	
Pollution severity	
Gauge to IEC 60947-1 / UL 94 flammability rating	
Approvals	
Clamped conductors (H05V/H07V)	
Solid / Stranded	mm ²
Flexible / Flexible with ferrule	mm ²
Stripping length / Blade size	mm/-

IEC 60947-7-2

IEC	UL	CSA	EN 60079-7
35	AWG 12...2	AWG 12...2	35 mm ²
1000 / 1500			
4200 A (35 mm ²)			
3			
/ V-0			

© CE CCC TÜV SÜD

Rated connection	
2.5...16 / 10...35	
10...35 / 2.5...35	
25 / 1.0 x 5.5 mm	

IEC 60947-7-2

IEC	UL	CSA	EN 60079-7
50	AWG 8...0	AWG 8...NaN	
1000 / 1500			
6000 A (50 mm ²)			
3			
/ V-0			

© CE CCC TÜV SÜD

Rated connection	
10...70 / 10...70	
10...70 / 10...50	
30 / 1.0 x 5.5 mm	

Note

If a cross-connection is mounted next to a PE terminal block or a terminal block for direct mounting, the rated voltage is reduced to 1000 V DC.

Ordering data

Version	Green/yellow
Note	

Type	Qty.	Order No.
A2C 35 PE	10	2551520000

Type	Qty.	Order No.
A2C 50/70 PE	5	2663280000

For 50 - 185 mm², the TS 35 x 15 (copper, 2.3 mm thick) mounting rail should be used.

Accessories

End plate	dark beige
End bracket	dark beige, screwable dark beige, direct mounting
Test adapter	1-pole stackable
Test plug	
Screwdriver	Standard
Marking tags	
Additional tap	green/yellow
Warning labels	

Type	Qty.	Order No.
AEB 35 SC/1	50	1991920000
AEB 35 SCL/1 V0	20	2661280000
ATPG 1.5-10 L	0.2 A 50	1991890000
PS 2.0 MC	20	0310000000
SDS 1.0X5.5X150	1	2749380000
WS-A 8/16 MM WS	200	2619910000
AAC 35 2X6 GN-YL	41 A 5	2583180000
AAM 35-185 YE FLASH	40	2635600000

Type	Qty.	Order No.
AEB 35 SC/1	50	1991920000
AEB 35 SCL/1 V0	20	2661280000
ATPG 1.5-10 L	0.2 A 50	1991890000
PS 2.0 MC	20	0310000000
SDS 1.0X5.5X150	1	2749380000
WS-A 8/16 MM WS	200	2619910000
AAC 50-185 2X10 GN-YL	57 A 5	2663440000
AAM 35-185 YE FLASH	40	2635600000

For detailed information on other accessories and application in the online catalogue



Spring connection with PUSH IN technology (A-Series)
PE terminal blocks

A2C 95/120 PE

95 mm²



25 x 101.5 x 90
/ 120
25...120



Width/Height/Depth mm
max. current / max. cond. cross-section -/mm²
Max. clamping range mm²

Technical data

Rated data	
for wire cross-section	mm ²
Rated voltage to adjoining terminal	V/V DC
Rated impulse withstand voltage to adjacent terminal	-
Rated short-time current	
Pollution severity	
Gauge to IEC 60947-1 / UL 94 flammability rating	
Approvals	
Clamped conductors (H05V/H07V)	
Solid / Stranded	mm ²
Flexible / Flexible with ferrule	mm ²
Stripping length / Blade size	mm/-

Note

Ordering data

Version	
	Green/yellow
Note	

Accessories

End plate	dark beige
End bracket	dark beige, screwable dark beige, direct mounting
Test adapter	1-pole stackable
Test plug	
Screwdriver	Standard
Marking tags	
Additional tap	green/yellow
Warning labels	

For detailed information on other accessories and application in the online catalogue

A2T 1.5 PE

1.5 mm²

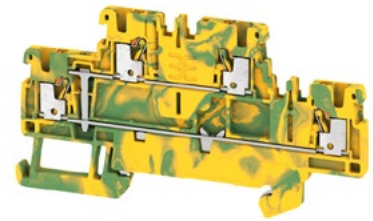

3.5 x 84 x 45
/ 1.5
0.14...1.5

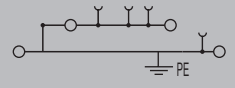

IEC 60947-7-2
Ex eb II C GbII
2 G D

Rated data			
IEC	UL	CSA	EN 60079-7
1.5	AWG 26...14	AWG 26...14	1.5 mm ²
500 /			
180 A (1.5 mm ²)			
3			
A1 / V-0			
Rated connection			
0.5...1.5 / 0.5...1.5			
0.5...1.5 / 0.5...1			
8 / 0.4 x 2.0 mm			

Note

Type	Qty.	Order No.
A2T 1.5 PE	50	2469410000

Type	Qty.	Order No.	
AEP 2T 1.5	20	2469420000	
AEB 35 SC/1	50	1991920000	
AEB 35 SCL/1 VO	20	2661280000	
ATPG 1.5-10 L	0.2 A	50	1991890000
ATPG 1.5 M-R	0.2 A	50	1991880000
PS 2.0 MC	20	0310000000	
SDIS 0.4X2.0X60	1	2749780000	
WS 10/3.5 PLUS MC NE WS	960	2003760000	
DEK 5/3.5 MM WS	1000	2007100000	
DEK 5/3.5 PLUS MC NE WS	1600	2003750000	
SNAPMARK 1.5	40	2682080000	
AAC 50-185 2X10 GN-YL	57 A	5	2663440000
AAM 35-185 YE FLASH	40	2635600000	

For detailed information on other accessories and application in the online catalogue

A2T 2.5 PE

2.5 mm²

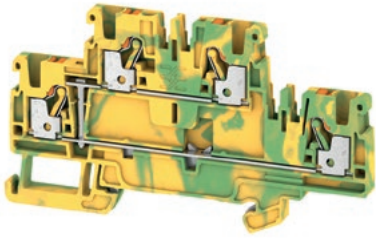

5.1 x 90 x 50.5
/ 4
0.14...4

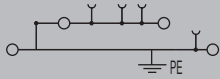

Ex eb II C GbII
2 G D



IEC 60947-7-2

IEC	UL	CSA	EN 60079-7
2.5	AWG 28...12	AWG 28...12	2.5 mm ²
800 /			

300 A (2.5 mm²)

3

A3 / V-0

© CE S VDE TÜV SÜD

Rated connection

0.5...2.5 / 0.5...4

0.5...4 / 0.5...2.5

10 / 0.6 x 3.5 mm

Type	Qty.	Order No.
A2T 2.5 PE	50	1547680000

Type	Qty.	Order No.
AEP 2T 2.5	20	1547690000
AEB 35 SC/1	50	1991920000
AEB 35 SCL/1 VO	20	2661280000
ATPG 1.5-10 L	0.2 A 50	1991890000
ATPG 2.5 MI-R	0.2 A 50	1991960000
PS 2.0 MC	20	0310000000
SDIL 0,6X3,5X100	1	2749140000
DEK 5/5 PLUS MC NE WS	1000	1854490000
DEK 5/5 MM WS	800	2007110000
WS 10/5 M PLUS MC NE WS	600	2003770000
SNAPMARK 1.5	40	2682080000
WS 8/5 MM WS	800	2007150000



Spring connection with PUSH IN technology (A-Series)

PE terminal blocks

A2T 2.5 3C PE

2.5 mm²



A2T 4 PE

4 mm²

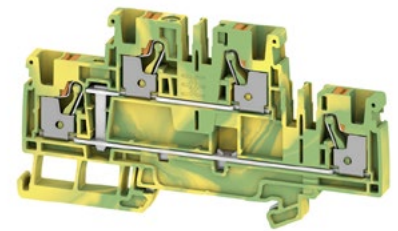

Width/Height/Depth	mm
max. current / max. cond. cross-section	-/mm ²
Max. clamping range	mm ²

5.1 x 114.2 x 64	
/ 4	
0.14...4	

6.1 x 100 x 53.5	
/ 6	
0.14...6	

Technical data

Rated data	
for wire cross-section	mm ²
Rated voltage to adjoining terminal	V
Rated impulse withstand voltage to adjacent terminal	-
Rated short-time current	
Pollution severity	
Gauge to IEC 60947-1 / UL 94 flammability rating	
Approvals	
Clamped conductors (H05V/H07V)	
Solid / Stranded	mm ²
Flexible / Flexible with ferrule	mm ²
Stripping length / Blade size	mm/-

IEC 60947-7-2

IEC	UL	CSA	EN 60079-7
2.5	AWG 28...12		2.5 mm ²
800			
300 A (2.5 mm ²)			
3			
A3 / V-0			



Rated connection	
0.5...2.5 / 0.5...4	
0.5...4 / 0.5...2.5	
10 / 0.6 x 3.5 mm	

IEC 60947-7-2

IEC	UL	CSA	EN 60079-7
4	AWG 26...10		4 mm ²
800			
8			
480 A (4 mm ²)			
3			
A4 / V-0			



Rated connection	
0.5...4 / 0.5...6	
0.5...6 / 0.5...4	
12 / 0.6 x 3.5 mm	

Note

Ordering data

Version	Green/yellow
Note	

Type	Qty.	Order No.
A2T 2.5 3C PE	50	2531320000

Type	Qty.	Order No.
A2T 4 PE	50	2539990000

Accessories

End plate	dark beige
End bracket	dark beige, screwable dark beige, direct mounting
Test adapter	1-pole stackable
Test plug	
Screwdriver	Standard
Marking tags	

Type	Qty.	Order No.
AEP 2T 2.5 3C	20	2532690000
AEB 35 SC/1	50	1991920000
AEB 35 SCL/1 V0	20	2661280000
ATPG 1.5-10 L	0.2 A 50	1991890000
ATPG 2.5 MHR	0.2 A 50	1991960000
PS 2.0 MC	20	0310000000
SDIL 0,6X3,5X100	1	2749140000
WS 10/5 M PLUS MC NE WS	600	2003770000
WS 8/5 MM WS	800	2007150000
DEK 5/5 MM WS	800	2007110000
DEK 5/5 PLUS MC NE WS	1000	1854490000

Type	Qty.	Order No.
AEP 2T 4	20	2540000000
AEB 35 SC/1	50	1991920000
AEB 35 SCL/1 V0	20	2661280000
ATPG 1.5-10 L	0.2 A 50	1991890000
ATPG 4 MHR	0.2 A 50	1991860000
PS 2.0 MC	20	0310000000
SDIL 0,6X3,5X100	1	2749140000
DEK 5/6 PLUS MC NE WS	1000	1011320000
WS 8/6 MM WS	600	2007160000
DEK 5/6 MM WS	600	2007120000
WS 10/6 M PLUS MC NE WS	600	2003780000
SNAPMARK I	50	1805880000

For detailed information on other accessories and application in the online catalogue

A3T 1.5 PE

1.5 mm²

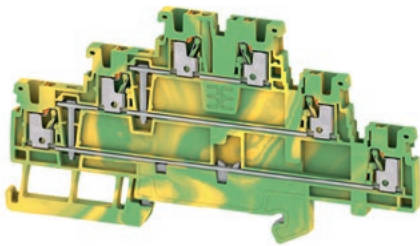

3.5 x 106.5 x 57
/ 1.5
0.14...1.5

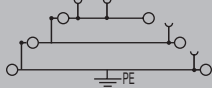

IEC 60947-7-2

IEC	UL	CSA	EN 60079-7
1.5			
500			
3			
A1 / V-0			

CE

Rated connection
0.5...1.5 / 0.5...1.5
0.5...1.5 / 0.5...1.5
8 / 0.4 x 2.0 mm

A3T 2.5 PE

2.5 mm²



5.1 x 116 x 64.5
/ 4
0.14...4

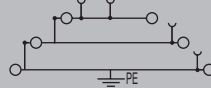

DIN EN 60947-7-2

IEC	UL	CSA	EN 60079-7
2.5	AWG 28...12	AWG 28...12	2.5 mm ²
800			
300 A (2.5 mm ²)			
3			
A3 / V-0			

© CE

Rated connection
0.5...2.5 / 0.5...4
0.5...4 / 0.5...2.5
10 / 0.6 x 3.5 mm

Ex eb II C GbII
2 G D

Type	Qty.	Order No.
A3T 1.5 PE	50	281800000

Type	Qty.	Order No.
A3T 2.5 PE	50	242855000

Type	Qty.	Order No.
AEP 3T 1.5	20	281695000
AEB 35 SC/1	50	199192000
AEB 35 SCL/1 VO	20	266128000
ATPG 1.5-10 L	0.2 A 50	199189000
ATPG 1.5 MI-R	0.2 A 50	199188000
PS 2.0 MC	20	031000000
SDS 0.4X2.0X60	1	274926000
DEK 5/3.5 PLUS MC NE WS	1600	200375000
DEK 5/3.5 MM WS	1000	200710000
WS 10/3.5 PLUS MC NE WS	960	200376000
SNAPMARK 1.5	40	268208000

Type	Qty.	Order No.
AEP 3T 2.5	20	242856000
AEB 35 SC/1	50	199192000
AEB 35 SCL/1 VO	20	266128000
ATPG 1.5-10 L	0.2 A 50	199189000
ATPG 2.5 MI-R	0.2 A 50	199196000
PS 2.0 MC	20	031000000
SDIL 0,6X3,5X100	1	274914000
WS 10/5 M PLUS MC NE WS	600	200377000
WS 8/5 MM WS	800	200715000
DEK 5/5 MM WS	800	200711000
DEK 5/5 PLUS MC NE WS	1000	185449000
SNAPMARK I	50	180588000



Spring connection with PUSH IN technology (A series)

Fuse terminals blocks

AFS 2.5 CF 2C

2.5 mm²

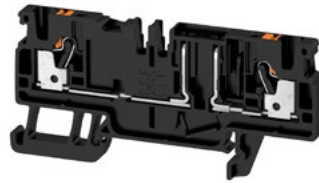

Width/Height/Depth	mm
max. current / max. cond. cross-section	A/mm ²
Max. clamping range	mm ²

5.1 x 77.5 x 37.65
10 / 4
0.14...4



Technical data

Rated data	
Rated voltage to adjoining terminal	V
Rated current	A
for wire cross-section	mm ²
Rated impulse withstand voltage / Pollution severity	
Gauge to IEC 60947-1 / UL 94 flammability rating	
Approvals	
Clamped conductors (H05V/H07V)	
Solid / Stranded	mm ²
Flexible / Flexible with ferrule	mm ²
Stripping length / Blade size	

In accordance with IEC 60947-7-3

IEC	UL	CSA	EN 60079-7
500	300 (C)	300 (C)	
10	16	16	
2.5	AWG 28...12	AWG 28...12	
/ 3			
A3 /			

CE

Rated connection

0.5...2.5 / 0.5...2.5
0.5...2.5 / 0.5...2.5
10 / 0.6 x 3.5 mm

Note

Ordering data

Version	
	400 V DC
	12 V DC
	24 V DC
Note	

Type	Qty.	Order No.
AFS 2.5 CF 2C BK	50	2466530000
AFS 2.5 CF 2C 12V BK	50	2466610000
AFS 2.5 CF 2C 24V BK	50	2466600000

Accessories

Plug-in cross-connection	
	2-pole
	10-pole
End plate	
	Black
Test plug	
Terminal blocks identical in contour	
Screwdriver	Standard
Marking tags	

Type	Qty.	Order No.
ZQV 2.5N/2	24 A 60	1527540000
ZQV 2.5N/10	24 A 20	1527690000
AEP 4C 2.5 BK	50	2486660000
PS 2.0 MC	20	0310000000
A3C 2.5	24 A 100	1521740000
A3C 2.5 PE	50	1521670000
ADT 2.5 2C	20 A 50	1989800000
A2C 2.5 /DT/FS	24 A 100	1989900000
A2C 2.5 PE /DT/FS	50	1989890000
SDIL 0,6X3,5X100	1	2749140000
DEK 5/5 PLUS MC NE WS	1000	1854490000
WS 10/5 M PLUS MC NE WS	600	2003770000
DEK 5/5 MM WS	800	2007110000
WS 8/5 MM WS	800	2007150000

For detailed information on other accessories and application in the online catalogue

Dimensions for blade-type fuse inserts according to DIN 72581-3:2001-03

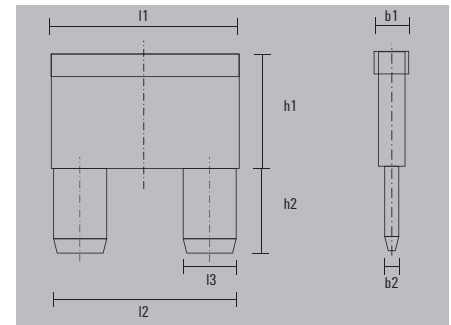

b1 max.	b2 ± 0.4	h1 max.	h2 ± 0.2	l1 max.	l2 ± 0.3	l3 ± 0.2
4	0.82	9	7.5	12	10.9	2.8

AFS 4 2C

4 mm²



Width/Height/Depth	mm
max. current / max. cond. cross-section	A/mm ²
Max. clamping range	mm ²

6.1 x 74 x 68
6.3 / 6
0.14...6

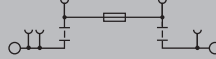

Technical data

Rated data	
Rated voltage to adjoining terminal	V
Rated current	A
for wire cross-section	mm ²
Rated impulse withstand voltage / Pollution severity	
Gauge to IEC 60947-1 / UL 94 flammability rating	
Approvals	
Clamped conductors (H05V/H07V)	
Solid / Stranded	mm ²
Flexible / Flexible with ferrule	mm ²
Stripping length / Blade size	
Note	

DIN EN 60947-7-3

Ex ec II
C Gc II 3 G D

IEC	UL	CSA	EN 60079-7
500	150 (C)	150 (C)	
6.3	10	10	6.3
4	AWG 26...10	AWG 26...10	4 mm ²
4 kV / 3			
A4 / V-0			
TUEV17ATEX8064U			
Rated connection			
0.5...4 / 0.5...6			
0.5...6 / 0.5...4			
12 / 0.6 x 3.5 mm			
Note			

Arrangement	Applications			
	Only short-circuit protection		Overload	
	T _a max.	Nominal values	T _a max.	Nominal values
Individual	41 °C	4,0 W / 6,3 A	31 °C	1,6 W / 6,3 A
In combination	32 °C	2,5 W / 6,3 A	34 °C	1,6 W / 6,3 A
Note				

Ordering data

Version	
	500 V AC/DC, without LED
	10-36 V AC/DC, with LED
	30-70 V AC/DC, with LED
	60-150 V AC/DC, with LED
	100 - 250 V AC/DC, with LED
Note	

Type	Qty.	Order No.
AFS 4 2C BK	50	2429860000
AFS 4 2C 10-36V BK	50	2429870000
AFS 4 2C 30-70V BK	50	2434350000
AFS 4 2C 60-150V BK	50	2434380000
AFS 4 2C 100-250V BK	50	2434390000
Note		

Accessories

Plug-in cross-connection	
	2-pole
	10-pole
End plate	
	Black
Test plug	
Terminal blocks identical in contour	
Screwdriver	
	Standard
Marking tags	
G-fuse cartridge, 5 x 20 mm (IEC 60127-2)	
	0.25 A fast
	0.50 A fast
	1.00 A fast
	2.00 A fast

Type	Qty.	Order No.
ZQV 4N/2	32 A 60	1527930000
ZQV 4N/10	32 A 20	1528090000
Note		
AEP 3C 4 BK	20	2486640000
Note		
PS 2.0 MC	20	0310000000
Note		
A3C 4	32 A 50	2051240000
A3C 4 PE	50	2051410000
Note		
SDIL 0,6X3,5X100	1	2749140000
Note		
DEK 5/6 PLUS MC NE WS	1000	1011320000
WS 10/6 M PLUS MC NE WS	600	2003780000
DEK 5/6 MM WS	600	2007120000
WS 8/6 MM WS	600	2007160000
Note		
G 20/0.25A/F	0.25 A 10	0430500000
G 20/0.50A/F	0.5 A 10	0430600000
G 20/1.00A/F	1 A 10	0430700000
G 20/2.00A/F	2 A 10	0430900000
Note		

For detailed information on other accessories and application in the online catalogue

Spring connection with PUSH IN technology (A series)

Fuse terminals blocks

AFS 4 2C BK/BL

4 mm²



Width/Height/Depth	mm
max. current / max. cond. cross-section	A/mm ²
Max. clamping range	mm ²

6.1 x 74 x 68
6.3 / 6
0.14...6

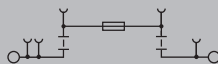

Technical data

Rated data	
Rated voltage to adjoining terminal	V
Rated current	A
for wire cross-section	mm ²
Rated impulse withstand voltage / Pollution severity	
Gauge to IEC 60947-1 / UL 94 flammability rating	
Approvals	
Clamped conductors (H05V/H07V)	
Solid / Stranded	mm ²
Flexible / Flexible with ferrule	mm ²
Stripping length / Blade size	

DIN EN 60947-7-3

IEC	UL	CSA	EN 60079-7
500	150 (C)	150 (C)	
6.3	10	10	6.3
4	AWG 26...10	AWG 26...10	4 mm ²
4 kV / 3			
A4 / V-0			
			TUEV17ATEX8064U
Rated connection			
0.5...4 / 0.5...6			
0.5...6 / 0.5...4			
12 / 0.6 x 3.5 mm			

Note

Ordering data

Version	500 V AC/DC, without LED
Note	

Type	Qty.	Order No.
AFS 4 2C BK/BL	50	2548140000

Accessories

Plug-in cross-connection	2-pole
	10-pole
End plate	Black
Test plug	
Terminal blocks identical in contour	
Screwdriver	Standard
Marking tags	
G-fuse cartridge, 5 x 20 mm (IEC 60127-2)	
	0.25 A fast
	0.50 A fast
	1.00 A fast
	2.00 A fast

Type	Qty.	Order No.
ZQV 4N/2	32 A 60	1527930000
ZQV 4N/10	32 A 20	1528090000
AEP 3C 4 BK	20	2486640000
PS 2.0 MC	20	0310000000
A3C 4	32 A 50	2051240000
A3C 4 PE	50	2051410000
SDIL 0,6X3,5X100	1	2749140000
DEK 5/6 PLUS MC NE WS	1000	1011320000
WS 10/6 M PLUS MC NE WS	600	2003780000
DEK 5/6 MM WS	600	2007120000
WS 8/6 MM WS	600	2007160000
G 20/0.25A/F	0.25 A 10	0430500000
G 20/0.50A/F	0.5 A 10	0430600000
G 20/1.00A/F	1 A 10	0430700000
G 20/2.00A/F	2 A 10	0430900000

Arrangement	Applications			
	Only short-circuit protection		Overload	
	T _A max.	Nominal values	T _A max.	Nominal values
Individual	41 °C	4,0 W / 6,3 A	31 °C	1,6 W / 6,3 A
In combination	32 °C	2,5 W / 6,3 A	34 °C	1,6 W / 6,3 A

For detailed information on other accessories and application in the online catalogue

A2T 4 FS-FT

4 mm²

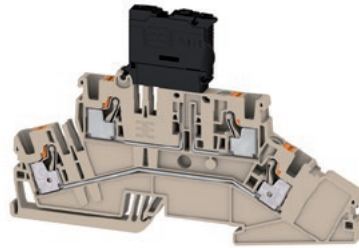

6.1 x 126.5 x 83.5
6.3 / 6
0.14...6

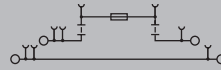

IEC 60947-7-3, IEC 60947-7-1

IEC	UL	CSA	EN 60079-7
500			
6.3			
4			
	6 kV / 3		
	A4 / V-0		
C€			
Rated connection			
0.5...4 / 0.5...6			
0.5...6 / 0.5...4			
12 / 0.6 x 3.5 mm			

A2T 4 FS-FT-PE

4 mm²

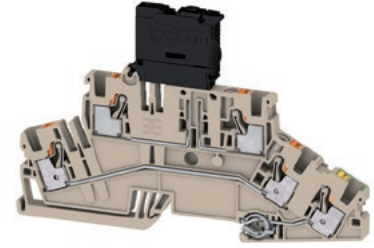

6.1 x 126.5 x 83.5
6.3 / 6
0.14...6



IEC 60947-7-1, IEC 60947-7-2, IEC 60947-7-3

IEC	UL	CSA	EN 60079-7
500			
6.3			
4			
	6 kV / 3		
	A4 / V-0		
C€			
Rated connection			
0.5...4 / 0.5...6			
0.5...6 / 0.5...4			
12 / 0.6 x 3.5 mm			

Width/Height/Depth mm
max. current / max. cond. cross-section A/mm²
Max. clamping range mm²

Technical data

Rated data	
Rated voltage to adjoining terminal	V
Rated current	A
for wire cross-section	mm ²
Rated impulse withstand voltage / Pollution severity	
Gauge to IEC 60947-1 / UL 94 flammability rating	
Approvals	
Clamped conductors (H05V/H07V)	
Solid / Stranded	mm ²
Flexible / Flexible with ferrule	mm ²
Stripping length / Blade size	
Note	

Ordering data

Version	
500 V AC/DC, without LED	
10-36 V AC/DC, with LED	
30-70 V AC/DC, with LED	
60-150 V AC/DC, with LED	
100 - 250 V AC/DC, with LED	
Note	

Accessories

Plug-in cross-connection	
	2-pole
	10-pole
End plate	
	dark beige
Test plug	
Terminal blocks identical in contour	
Screwdriver	
	Standard
Marking tags	
G-fuse cartridge, 5 x 20 mm (IEC 60127-2)	
0.25 A fast	
0.50 A fast	
1.00 A fast	
2.00 A fast	

Type	Qty.	Order No.
A2T 4 FS-FT	50	2831500000

Type	Qty.	Order No.
ZQV 4N/2	32 A 60	1527930000
ZQV 4N/10	32 A 20	1528090000
AEP 2T 4 FS	20	2817060000
PS 2.0 MC	20	0310000000
A2T 4 DT-FT	20 A 50	2831520000
A2T 4 DT-FT-PE	20 A 50	2831530000
A2T 4 FS-FT-PE	6.3 A 50	2831510000
SDIL 0,6X3,5X100	1	2749140000
DEK 5/6 PLUS MC NE WS	1000	1011320000
WS 10/6 M PLUS MC NE WS	600	2003780000
DEK 5/6 MM WS	600	2007120000
WS 8/6 MM WS	600	2007160000
G 20/0.25A/F	0.25 A 10	0430500000
G 20/0.50A/F	0.5 A 10	0430600000
G 20/1.00A/F	1 A 10	0430700000
G 20/2.00A/F	2 A 10	0430900000

Type	Qty.	Order No.
A2T 4 FS-FT-PE	50	2831510000

Type	Qty.	Order No.
ZQV 4N/2	32 A 60	1527930000
ZQV 4N/10	32 A 20	1528090000
AEP 2T 4 FS	20	2817060000
PS 2.0 MC	20	0310000000
A2T 4 DT-FT	20 A 50	2831520000
A2T 4 DT-FT-PE	20 A 50	2831530000
A2T 4 FS-FT	6.3 A 50	2831500000
SDIL 0,6X3,5X100	1	2749140000
DEK 5/6 PLUS MC NE WS	1000	1011320000
WS 10/6 M PLUS MC NE WS	600	2003780000
DEK 5/6 MM WS	600	2007120000
WS 8/6 MM WS	600	2007160000
G 20/0.25A/F	0.25 A 10	0430500000
G 20/0.50A/F	0.5 A 10	0430600000
G 20/1.00A/F	1 A 10	0430700000
G 20/2.00A/F	2 A 10	0430900000

For detailed information on other accessories and application in the online catalogue



Spring connection with PUSH IN technology (A series)

Fuse terminals blocks

A2T 4 FS-FT BK

4 mm²



A2T 4 FS-FT-PE BK

4 mm²



Width/Height/Depth	mm
max. current / max. cond. cross-section	A/mm ²
Max. clamping range	mm ²

6.1 x 126.5 x 83.5
6.3 / 6
0.14...6

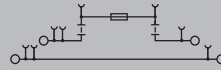

6.1 x 126.5 x 83.5
6.3 / 6
0.14...6



Technical data

Rated data	
Rated voltage to adjoining terminal	V
Rated current	A
for wire cross-section	mm ²
Rated impulse withstand voltage / Pollution severity	
Gauge to IEC 60947-1 / UL 94 flammability rating	
Approvals	
Clamped conductors (H05V/H07V)	
Solid / Stranded	mm ²
Flexible / Flexible with ferrule	mm ²
Stripping length / Blade size	
Note	

IEC 60947-7-3, IEC 60947-7-1

IEC	UL	CSA	EN 60079-7
500			
6.3			
4			
		6 kV / 3	
		A4 / V-0	
CE			
Rated connection			
0.5...4 / 0.5...6			
0.5...6 / 0.5...4			
12 / 0.6 x 3.5 mm			
Note			

IEC 60947-7-1, IEC 60947-7-2, IEC 60947-7-3

IEC	UL	CSA	EN 60079-7
500			
6.3			
4			
		6 kV / 3	
		A4 / V-0	
CE			
Rated connection			
0.5...4 / 0.5...6			
0.5...6 / 0.5...4			
12 / 0.6 x 3.5 mm			
Note			

Ordering data

Version	
	500 V AC/DC, without LED
	10-36 V AC/DC, with LED
	30-70 V AC/DC, with LED
	60-150 V AC/DC, with LED
	100 - 250 V AC/DC, with LED
Note	

Type	Qty.	Order No.
A2T 4 FS-FT BK	50	2816960000
A2T 4 FS-FT 10-36V BK	50	2816970000
A2T 4 FS-FT 30-70V BK	50	2816980000
A2T 4 FS-FT 60-150V BK	50	2816990000
A2T 4 FS-FT 100-250V BK	50	2817000000
Note		

Type	Qty.	Order No.
A2T 4 FS-FT-PE BK	50	2817010000
A2T 4 FS-FT-PE 10-36V BK	50	2817020000
A2T 4 FS-FT-PE 30-70V BK	50	2817030000
A2T 4 FS-FT-PE 60-150V BK	50	2817040000
A2T 4 FS-FT-PE 100-250V BK	50	2817050000
Note		

Accessories

Plug-in cross-connection	
	2-pole
	10-pole
End plate	
	dark beige
Test plug	
Terminal blocks identical in contour	
Screwdriver	
	Standard
Marking tags	
G-fuse cartridge, 5 x 20 mm (IEC 60127-2)	
	0.25 A fast
	0.50 A fast
	1.00 A fast
	2.00 A fast

Type	Qty.	Order No.
ZQV 4N/2	32 A 60	1527930000
ZQV 4N/10	32 A 20	1528090000
Note		
AEP 2T 4 FS	20	2817060000
Note		
PS 2.0 MC	20	0310000000
Note		
A2T 4 DT-FT	20 A 50	2831520000
A2T 4 DT-FT-PE	20 A 50	2831530000
A2T 4 FS-FT-PE BK	6.3 A 50	2817010000
Note		
SDIL 0,6X3,5X100	1	2749140000
Note		
DEK 5/6 PLUS MC NE WS	1000	1011320000
WS 10/6 M PLUS MC NE WS	600	2003780000
DEK 5/6 MM WS	600	2007120000
WS 8/6 MM WS	600	2007160000
Note		
G 20/0.25A/F	0.25 A 10	0430500000
G 20/0.50A/F	0.5 A 10	0430600000
G 20/1.00A/F	1 A 10	0430700000
G 20/2.00A/F	2 A 10	0430900000
Note		

Type	Qty.	Order No.
ZQV 4N/2	32 A 60	1527930000
ZQV 4N/10	32 A 20	1528090000
Note		
AEP 2T 4 FS	20	2817060000
Note		
PS 2.0 MC	20	0310000000
Note		
A2T 4 DT-FT	20 A 50	2831520000
A2T 4 DT-FT-PE	20 A 50	2831530000
A2T 4 FS-FT BK	6.3 A 50	2816960000
Note		
SDIL 0,6X3,5X100	1	2749140000
Note		
DEK 5/6 PLUS MC NE WS	1000	1011320000
WS 10/6 M PLUS MC NE WS	600	2003780000
DEK 5/6 MM WS	600	2007120000
WS 8/6 MM WS	600	2007160000
Note		
G 20/0.25A/F	0.25 A 10	0430500000
G 20/0.50A/F	0.5 A 10	0430600000
G 20/1.00A/F	1 A 10	0430700000
G 20/2.00A/F	2 A 10	0430900000
Note		

For detailed information on other accessories and application in the online catalogue



VDS180 SV7.62



Type	Qty.	Order No.
VDS180 SV7.62	50	1853940000

Spring connection with PUSH IN technology (A-Series)
Test-disconnect terminal blocks

Universal range

A

ADT 2.5 2C

2.5 mm²

ADT 2.5 2C W/O DTLV

2.5 mm²

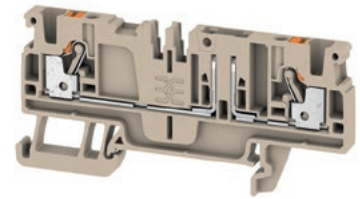
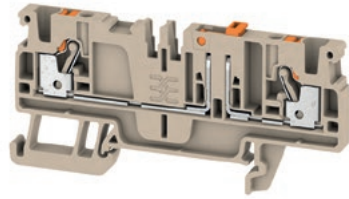

Width/Height/Depth	mm
max. current / max. cond. cross-section	A/mm ²
Max. clamping range	mm ²

5.1 x 77.5 x 37.65	
20 / 4	
0.14...4	

5.1 x 77.5 x 36.5	
20 / 4	
0.14...4	

Technical data

Rated data	
Rated voltage of feed-through terminal	V
Rated current	A
for wire cross-section	mm ²
Rated impulse withstand voltage / Pollution severity	
Gauge to IEC 60947-1 / UL 94 flammability rating	
Number of operating cycles	
Approvals	
Clamped conductors (H05V/H07V)	
Solid / Stranded	mm ²
Flexible / Flexible with ferrule	mm ²
Stripping length / Blade size	mm/-
Note	

IEC 60947-7-1

IEC	UL	CSA	EN 60079-7
500	300	300	
20	20	20	
2.5	AWG 28...12	AWG 28...12	
6 kV / 3			
A3 / V-0			

Rated connection	
0.5...2.5 / 0.5...4	
0.5...4 / 0.5...2.5	
10 / 0.6 x 3.5 mm	

IEC 60947-7-1

IEC	UL	CSA	EN 60079-7
500	300	300	
20	20	20	
2.5	AWG 28...12	AWG 28...12	
6 kV / 3			
A3 / V-0			

Rated connection	
0.5...2.5 / 0.5...4	
0.5...4 / 0.5...2.5	
10 / 0.6 x 3.5 mm	

Ordering data

Version	
	dark beige
	Blue
	without isolator
Note	

Type	Qty.	Order No.
ADT 2.5 2C	50	1989800000
ADT 2.5 2C BL	50	1989810000

Type	Qty.	Order No.
ADT 2.5 2C W/O DTLV	50	1989930000

Accessories

Plug-in cross-connection	
	2-pole
	10-pole
	2-pole
	10-pole
End plate	
	dark beige
	Blue
End bracket	
	dark beige, screwable
	dark beige, direct mounting
Test adapter	
	1-pole
	stackable
	3-pole
	5-pole
Test plug	
Screwdriver	
	Standard
Marking tags	

Type	Qty.	Order No.
ZQV 2.5N/2	24 A 60	1527540000
ZQV 2.5N/10	24 A 20	1527690000
AEP 4C 2.5		
AEP 4C 2.5	50	1521530000
AEP 4C 2.5 BL	50	1521640000
AEB 35 SC/1		
AEB 35 SC/1	50	1991920000
AEB 35 SCL/1 V0	20	2661280000
ATPG 1.5-10 L		
ATPG 1.5-10 L	0.2 A 50	1991890000
ATPG 2.5 MHR	0.2 A 50	1991960000
ATPG 2.5/3	0.2 A 25	2041190000
ATPG 2.5/5	0.2 A 25	2041180000
PS 2.0 MC		
PS 2.0 MC	20	0310000000
SDIL 0,6X3,5X100		
SDIL 0,6X3,5X100	1	2749140000
DEK 5/5 PLUS MC NE WS		
DEK 5/5 PLUS MC NE WS	1000	1854490000
DEK 5/5 MM WS	800	2007110000
WS 8/5 MM WS	800	2007150000
WS 10/5 M PLUS MC NE WS	600	2003770000

Type	Qty.	Order No.
ZQV 2.5N/2	24 A 60	1527540000
ZQV 2.5N/10	24 A 20	1527690000
AEP 4C 2.5		
AEP 4C 2.5	50	1521530000
AEP 4C 2.5 BL	50	1521640000
AEB 35 SC/1		
AEB 35 SC/1	50	1991920000
AEB 35 SCL/1 V0	20	2661280000
ATPG 1.5-10 L		
ATPG 1.5-10 L	0.2 A 50	1991890000
ATPG 2.5 MHR	0.2 A 50	1991960000
ATPG 2.5/3	0.2 A 25	2041190000
ATPG 2.5/5	0.2 A 25	2041180000
PS 2.0 MC		
PS 2.0 MC	20	0310000000
SDIL 0,6X3,5X100		
SDIL 0,6X3,5X100	1	2749140000
DEK 5/5 PLUS MC NE WS		
DEK 5/5 PLUS MC NE WS	1000	1854490000
DEK 5/5 MM WS	800	2007110000
WS 8/5 MM WS	800	2007150000
WS 10/5 M PLUS MC NE WS	600	2003770000

For detailed information on other accessories and application in the online catalogue

A2C 2.5 /DT/FS

2.5 mm²

A2C 2.5 PE /DT/FS

2.5 mm²

ADT 2.5 3C

2.5 mm²

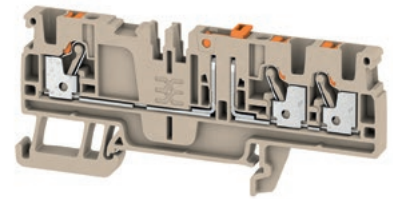
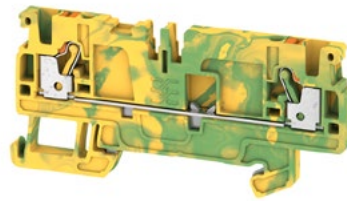
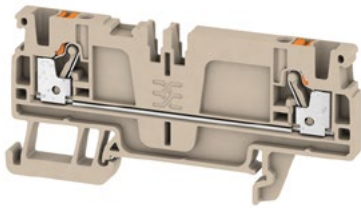

5.1 x 77.5 x 36.5
24 / 4
0.14...4



5.1 x 77.5 x 36.5
/ 4
0.14...4

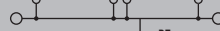

5.1 x 84.5 x 37.65
20 / 4
0.14...4



IEC 60947-7-1

IEC	UL	CSA	EN 60079-7
800	600	600	
24	20	20	
2.5	AWG 28...12	AWG 28...12	
8 kV / 3			
A3 / V-0			

IEC 60947-7-2

IEC	UL	CSA	EN 60079-7
	600	600	
2.5	AWG 28...12	AWG 28...12	
8 kV / 3			
A3 / V-0			

IEC 60947-7-1

IEC	UL	CSA	EN 60079-7
500	300	300	
20	20	20	
2.5	AWG 28...12	AWG 28...12	
6 kV / 3			
A3 / V-0			



Rated connection

0.5...2.5 / 0.5...4
0.5...4 / 0.5...2.5
10 / 0.6 x 3.5 mm



Rated connection

0.5...2.5 / 0.5...4
0.5...4 / 0.5...2.5
10 / 0.6 x 3.5 mm



Rated connection

0.5...2.5 / 0.5...4
0.5...4 / 0.5...2.5
10 / 0.6 x 3.5 mm

Type	Qty.	Order No.
A2C 2.5 /DT/FS	100	1989900000
A2C 2.5 /DT/FS BL	100	1989910000

Type	Qty.	Order No.
A2C 2.5 PE /DT/FS	50	1989890000

Type	Qty.	Order No.
ADT 2.5 3C	50	1989830000
ADT 2.5 3C BL	50	1989840000

Type	Qty.	Order No.
ZQV 2.5N/2	24 A 60	1527540000
ZQV 2.5N/10	24 A 20	1527690000
AEP 4C 2.5	50	1521530000
AEP 4C 2.5 BL	50	1521640000
AEB 35 SC/1	50	1991920000
AEB 35 SCL/1 VO	20	2661280000
ATPG 1.5-10 L	0.2 A 50	1991890000
ATPG 2.5 MI-R	0.2 A 50	1991960000
ATPG 2.5/3	0.2 A 25	2041190000
ATPG 2.5/5	0.2 A 25	2041180000
PS 2.0 MC	20	0310000000
SDIL 0,6X3,5X100	1	2749140000
DEK 5/5 PLUS MC NE WS	1000	1854490000
DEK 5/5 MM WS	800	2007110000
WS 8/5 MM WS	800	2007150000
WS 10/5 M PLUS MC NE WS	600	2003770000

Type	Qty.	Order No.
AEP 4C 2.5	50	1521530000
AEB 35 SC/1	50	1991920000
AEB 35 SCL/1 VO	20	2661280000
ATPG 1.5-10 L	0.2 A 50	1991890000
ATPG 2.5 MI-R	0.2 A 50	1991960000
ATPG 2.5/3	0.2 A 25	2041190000
ATPG 2.5/5	0.2 A 25	2041180000
PS 2.0 MC	20	0310000000
SDIL 0,6X3,5X100	1	2749140000
DEK 5/5 PLUS MC NE WS	1000	1854490000
DEK 5/5 MM WS	800	2007110000
WS 8/5 MM WS	800	2007150000
WS 10/5 M PLUS MC NE WS	600	2003770000

Type	Qty.	Order No.
ZQV 2.5N/2	24 A 60	1527540000
ZQV 2.5N/10	24 A 20	1527690000
AEP DT 2.5 3C	50	1989970000
AEB 35 SC/1	50	1991920000
AEB 35 SCL/1 VO	20	2661280000
ATPG 1.5-10 L	0.2 A 50	1991890000
ATPG 2.5 MI-R	0.2 A 50	1991960000
ATPG 2.5/3	0.2 A 25	2041190000
ATPG 2.5/5	0.2 A 25	2041180000
PS 2.0 MC	20	0310000000
SDIL 0,6X3,5X100	1	2749140000
DEK 5/5 PLUS MC NE WS	1000	1854490000
DEK 5/5 MM WS	800	2007110000
WS 8/5 MM WS	800	2007150000
WS 10/5 M PLUS MC NE WS	600	2003770000



Spring connection with PUSH IN technology (A-Series)

Test-disconnect terminal blocks

Universal range

A

ADT 2.5 3C W/O DTLV

2.5 mm²

ADT 2.5 4C

2.5 mm²

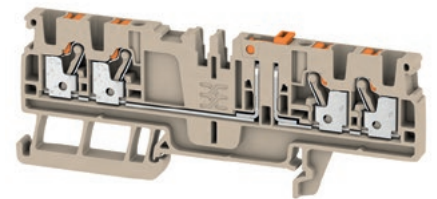
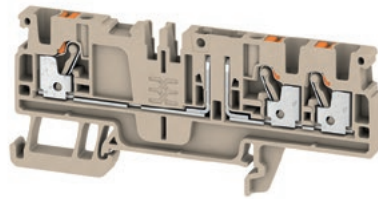

Width/Height/Depth	mm
max. current / max. cond. cross-section	A/mm ²
Max. clamping range	mm ²

5.1 x 84.5 x 36.5	
20 / 4	
0.14...4	

5.1 x 96 x 37.65	
20 / 4	
0.14...4	

Technical data

Rated data	
Rated voltage of feed-through terminal	V
Rated current	A
for wire cross-section	mm ²
Rated impulse withstand voltage / Pollution severity	
Gauge to IEC 60947-1 / UL 94 flammability rating	
Number of operating cycles	
Approvals	
Clamped conductors (H05V/H07V)	
Solid / Stranded	mm ²
Flexible / Flexible with ferrule	mm ²
Stripping length / Blade size	mm/-
Note	

IEC 60947-7-1

IEC	UL	CSA	EN 60079-7
500	300	300	
20	20	20	
2.5	AWG 28...12	AWG 28...12	
6 kV / 3			
A3 / V-0			

CE, RoHS, REACH, PAHs, EN61010, IEC60947, IEC60364

Rated connection	
0.5...2.5 / 0.5...4	
0.5...4 / 0.5...2.5	
10 / 0.6 x 3.5 mm	

IEC 60947-7-1

IEC	UL	CSA	EN 60079-7
500	300	300	
20	20	20	
2.5	AWG 28...12	AWG 28...12	
6 kV / 3			
A3 / V-0			

CE, RoHS, REACH, PAHs, EN61010, IEC60947, IEC60364

Rated connection	
0.5...2.5 / 0.5...4	
0.5...4 / 0.5...2.5	
10 / 0.6 x 3.5 mm	

Ordering data

Version	
	dark beige
	Blue
	without isolator
Note	

Type	Qty.	Order No.
ADT 2.5 3C W/O DTLV	50	1989940000

Type	Qty.	Order No.
ADT 2.5 4C	50	1989860000
ADT 2.5 4C BL	50	1989870000

Accessories

Plug-in cross-connection	
	2-pole
	10-pole
	2-pole
	10-pole
End plate	
	dark beige
	Blue
End bracket	
	dark beige, screwable
	dark beige, direct mounting
Test adapter	
	1-pole
	stackable
	3-pole
	5-pole
Test plug	
Screwdriver	
	Standard
Marking tags	

Type	Qty.	Order No.
ZQV 2.5N/2	24 A 60	1527540000
ZQV 2.5N/10	24 A 20	1527690000
AEP DT 2.5 3C		
AEP DT 2.5 3C	50	1989970000
AEB 35 SC/1		
AEB 35 SC/1	50	1991920000
AEB 35 SCL/1 V0	20	2661280000
ATPG 1.5-10 L		
ATPG 1.5-10 L	0.2 A 50	1991890000
ATPG 2.5 MHR		
ATPG 2.5 MHR	0.2 A 50	1991960000
ATPG 2.5/3		
ATPG 2.5/3	0.2 A 25	2041190000
ATPG 2.5/5		
ATPG 2.5/5	0.2 A 25	2041180000
PS 2.0 MC		
PS 2.0 MC	20	0310000000
SDIL 0,6X3,5X100		
SDIL 0,6X3,5X100	1	2749140000
DEK 5/5 PLUS MC NE WS		
DEK 5/5 PLUS MC NE WS	1000	1854490000
DEK 5/5 MM WS		
DEK 5/5 MM WS	800	2007110000
WS 8/5 MM WS		
WS 8/5 MM WS	800	2007150000
WS 10/5 M PLUS MC NE WS		
WS 10/5 M PLUS MC NE WS	600	2003770000

Type	Qty.	Order No.
ZQV 2.5N/2	24 A 60	1527540000
ZQV 2.5N/10	24 A 20	1527690000
AEP DT 2.5 4C		
AEP DT 2.5 4C	50	1989980000
AEB 35 SC/1		
AEB 35 SC/1	50	1991920000
AEB 35 SCL/1 V0	20	2661280000
ATPG 1.5-10 L		
ATPG 1.5-10 L	0.2 A 50	1991890000
ATPG 2.5 MHR		
ATPG 2.5 MHR	0.2 A 50	1991960000
ATPG 2.5/3		
ATPG 2.5/3	0.2 A 25	2041190000
ATPG 2.5/5		
ATPG 2.5/5	0.2 A 25	2041180000
PS 2.0 MC		
PS 2.0 MC	20	0310000000
SDIL 0,6X3,5X100		
SDIL 0,6X3,5X100	1	2749140000
DEK 5/5 PLUS MC NE WS		
DEK 5/5 PLUS MC NE WS	1000	1854490000
DEK 5/5 MM WS		
DEK 5/5 MM WS	800	2007110000
WS 8/5 MM WS		
WS 8/5 MM WS	800	2007150000
WS 10/5 M PLUS MC NE WS		
WS 10/5 M PLUS MC NE WS	600	2003770000

For detailed information on other accessories and application in the online catalogue

ADT 2.5 4C W/O DTLV

2.5 mm²

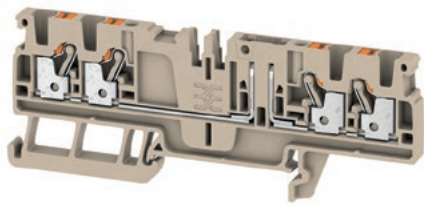

5.1 x 96 x 36.5
20 / 4
0.14...4



IEC 60947-7-1

IEC	UL	CSA	EN 60079-7
500	300	300	
20	20	20	
2.5	AWG 28...12	AWG 28...12	
6 kV / 3			
A3 / V-0			

CE

Rated connection

0.5...2.5 / 0.5...4
0.5...4 / 0.5...2.5
10 / 0.6 x 3.5 mm

ADT 4 2C

4 mm²

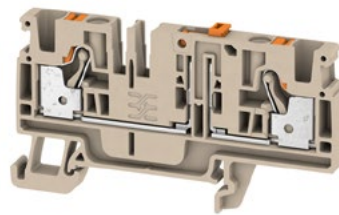

6.1 x 74 x 41
20 / 6
0.14...6



IEC/EN 60947-7-1:2009

IEC	UL	CSA	EN 60079-7
500	600	600	
20	20	20	
4	AWG 26...10	AWG 26...10	
4 kV / 3			
A4 / V-0			

CE

Rated connection

0.5...4 / 0.5...6
0.5...6 / 0.5...4
10 / 0.6 x 3.5 mm

Type	Qty.	Order No.
ADT 2.5 4C W/O DTLV	50	1989950000

Type	Qty.	Order No.
ADT 4 2C	50	2429850000
ADT 4 2C BL	50	2429880000

Type	Qty.	Order No.
ZQV 2.5N/2	24 A 60	1527540000
ZQV 2.5N/10	24 A 20	1527690000
AEP DT 2.5 4C	50	1989980000
AEB 35 SC/1	50	1991920000
AEB 35 SCL/1 VO	20	2661280000
ATPG 1.5-10 L	0.2 A 50	1991890000
ATPG 2.5 MI-R	0.2 A 50	1991960000
ATPG 2.5/3	0.2 A 25	2041190000
ATPG 2.5/5	0.2 A 25	2041180000
PS 2.0 MC	20	0310000000
SDIL 0,6X3,5X100	1	2749140000
DEK 5/5 PLUS MC NE WS	1000	1854490000
DEK 5/5 MM WS	800	2007110000
WS 8/5 MM WS	800	2007150000
WS 10/5 M PLUS MC NE WS	600	2003770000

Type	Qty.	Order No.
ZQV 4N/2	32 A 60	1527930000
ZQV 4N/10	32 A 20	1528090000
AEP 4C 4	20	2051900000
AEP 4C 4 BL	20	2051910000
AEB 35 SC/1	50	1991920000
AEB 35 SCL/1 VO	20	2661280000
ATPG 1.5-10 L	0.2 A 50	1991890000
ATPG 4 MHR	0.2 A 50	1991860000
PS 2.0 MC	20	0310000000
SDIL 0,6X3,5X100	1	2749140000
WS 10/6 M PLUS MC NE WS	600	2003780000
DEK 5/6 MM WS	600	2007120000
WS 8/6 MM WS	600	2007160000
DEK 5/6 PLUS MC NE WS	1000	1011320000



Spring connection with PUSH IN technology (A-Series)

Test-disconnect terminal blocks

A2T 2.5 DT/DT

2.5 mm²

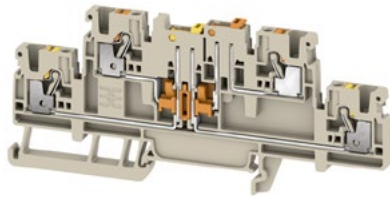

A2T 2.5 DT/FT

2.5 mm²

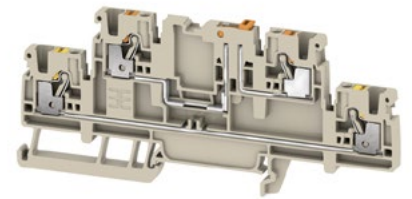

Width/Height/Depth	mm
max. current / max. cond. cross-section	A/mm ²
Max. clamping range	mm ²

5.1 x 115 x 50.5	
16 / 4	
0.14...4	

5.1 x 115 x 50.5	
16 / 4	
0.14...4	

Technical data

Rated data	
Rated voltage of feed-through terminal	V
Rated current	A
for wire cross-section	mm ²
Rated impulse withstand voltage / Pollution severity	
Gauge to IEC 60947-1 / UL 94 flammability rating	
Number of operating cycles	
Approvals	
Clamped conductors (H05V/H07V)	
Solid / Stranded	mm ²
Flexible / Flexible with ferrule	mm ²
Stripping length / Blade size	mm/-
Note	

IEC 60947-7-1			
IEC	UL	CSA	EN 60079-7
400	300	300	
16	19	19	
2.5	AWG 26...12	AWG 26...12	
6 kV / 3			
A3 / V-0			
Rated connection			
0.5...2.5 / 0.5...2.5			
0.5...2.5 / 0.5...2.5			
10 / 0.6 x 3.5 mm			
Note			

IEC 60947-7-1			
IEC	UL	CSA	EN 60079-7
400	300	300	
16	19	19	
2.5	AWG 26...12	AWG 26...12	
6 kV / 3			
A3 / V-0			
Rated connection			
0.5...2.5 / 0.5...2.5			
0.5...2.5 / 0.5...2.5			
10 / 0.6 x 3.5 mm			
Note			

Ordering data

Version	
	dark beige
	Blue
Note	

Type	Qty.	Order No.
A2T 2.5 DT/DT	50	2744110000
A2T 2.5 DT/DT BL	50	2744120000
Note		

Type	Qty.	Order No.
A2T 2.5 DT/FT	50	2744130000
A2T 2.5 DT/FT BL	50	2744140000
Note		

Accessories

Plug-in cross-connection	
	2-pole
	10-pole
End plate	
	dark beige
	blue
End bracket	
	dark beige, screwable
	dark beige, direct mounting
Test adapter	
	1-pole
	stackable
Screwdriver	
	Standard
Marking tags	
Holder for cartridge fuse 5 x 20 mm	
	400 V AC/DC, without LED
	10 - 36 V AC/DC, red LED
	35 - 70 V AC/DC, red LED
	60 - 150 V AC/DC, red LED
	140 - 250 V AC/DC, red LED
Disconnect plug	
	orange
	removable, as replacement for release lever
Module connector (max. 250 V)	
	without fittings
	With 1N4007 diode
	with wire jumper
For detailed information on other accessories and application in the online catalogue	

Type	Qty.	Order No.
ZQV 2.5N/2	24 A 60	1527540000
ZQV 2.5N/10	24 A 20	1527690000
Note		
AEP DT 2.5 2T	20	2744150000
AEP DT 2.5 2T BL	20	2744160000
Note		
AEB 35 SC/1	50	1991920000
AEB 35 SCL/1 VO	20	2661280000
Note		
ATPG 1.5-10 L	0.2 A 50	1991890000
ATPG 2.5 M-R	0.2 A 50	1991960000
Note		
SDIL 0,6X3,5X100	1	2749140000
Note		
DEK 5/5 PLUS MC NE WS	1000	1854490000
DEK 5/5 MM WS	800	2007110000
WS 8/5 MM WS	800	2007150000
Note		
SIHA 3/G20	6.3 A 25	7921560000
SIHA 3/G20/LD 10-36V	25	7921570000
SIHA 3/G20/LD 35-70V	25	7921580000
SIHA 3/G20/LD 60-150V	25	7921590000
SIHA 3/G20/LD 140-250V	25	7921600000
Note		
TNST OR	20 A 50	2463540000
TNST	20 A 50	1833090000
Note		
BEST	50	1833100000
BEST/D	1 A 50	1878560000
BEST/DRBR	22 A 50	1878570000
Note		

Type	Qty.	Order No.
ZQV 2.5N/2	24 A 60	1527540000
ZQV 2.5N/10	24 A 20	1527690000
Note		
AEP DT 2.5 2T	20	2744150000
AEP DT 2.5 2T BL	20	2744160000
Note		
AEB 35 SC/1	50	1991920000
AEB 35 SCL/1 VO	20	2661280000
Note		
ATPG 1.5-10 L	0.2 A 50	1991890000
ATPG 2.5 M-R	0.2 A 50	1991960000
Note		
SDIL 0,6X3,5X100	1	2749140000
Note		
DEK 5/5 PLUS MC NE WS	1000	1854490000
DEK 5/5 MM WS	800	2007110000
WS 8/5 MM WS	800	2007150000
Note		
SIHA 3/G20	6.3 A 25	7921560000
SIHA 3/G20/LD 10-36V	25	7921570000
SIHA 3/G20/LD 35-70V	25	7921580000
SIHA 3/G20/LD 60-150V	25	7921590000
SIHA 3/G20/LD 140-250V	25	7921600000
Note		
TNST OR	20 A 50	2463540000
TNST	20 A 50	1833090000
Note		
BEST	50	1833100000
BEST/D	1 A 50	1878560000
BEST/DRBR	22 A 50	1878570000
Note		

A2T 4 DT-FT

4 mm²

A2T 4 DT-FT-PE

4 mm²

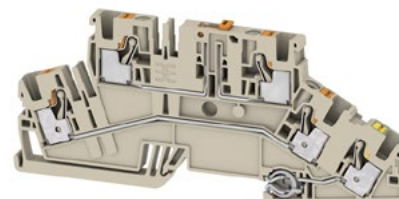
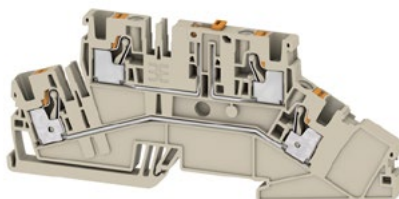

Width/Height/Depth	mm
max. current / max. cond. cross-section	A/mm ²
Max. clamping range	mm ²

6.1 x 126.5 x 56.5
20 / 6
0.14...6

6.1 x 126.5 x 56.5
20 / 6
0.14...6

Technical data

Rated data	
Rated voltage of feed-through terminal	V
Rated current	A
for wire cross-section	mm ²
Rated impulse withstand voltage / Pollution severity	
Gauge to IEC 60947-1 / UL 94 flammability rating	
Number of operating cycles	
Approvals	
Clamped conductors (H05V/H07V)	
Solid / Stranded	mm ²
Flexible / Flexible with ferrule	mm ²
Stripping length / Blade size	mm/-

IEC 60947-7-1, IEC 60947-7-2

IEC	UL	CSA	EN 60079-7
250			
20			
4			
	6 kV / 3		
	A4 / V-0		

IEC 60947-7-1, IEC 60947-7-2

IEC	UL	CSA	EN 60079-7
250			
20			
4			
	6 kV / 3		
	A4 / V-0		

Note

CE

CE

Ordering data

Version	
	dark beige
	without isolator, dark beige
Note	

Type	Qty.	Order No.
A2T 4 DT-FT	50	2831520000
A2T 4 DT-FT W/O DTLV	50	2831540000

Type	Qty.	Order No.
A2T 4 DT-FT-PE	50	2831530000
A2T 4 DT-FT-PE W/O DTLV	50	2831550000

Accessories

Plug-in cross-connection	
	2-pole
	10-pole
End plate	dark beige
End bracket	dark beige, screwable dark beige, direct mounting
Test adapter	1-pole stackable
Screwdriver	Standard
Marking tags	
Holder for cartridge fuse 5 x 20 mm	400 V AC/DC, without LED 10 - 36 V AC/DC, red LED 35 - 70 V AC/DC, red LED 60 - 150 V AC/DC, red LED 140 - 250 V AC/DC, red LED
Disconnect plug	orange removable, as replacement for release lever
Module connector (max. 250 V)	without fittings With 1N4007 diode with wire jumper
For detailed information on other accessories and application in the online catalogue	

Type	Qty.	Order No.
ZQV 4N/2	32 A 60	1527930000
ZQV 4N/10	32 A 20	1528090000
AEP 2T 4 FS	20	2817060000
AEB 35 SC/1	50	1991920000
AEB 35 SCL/1 VO	20	2661280000
ATPG 1.5-10 L	0.2 A 50	1991890000
ATPG 4 MHR	0.2 A 50	1991860000
SDIL 0,6X3,5X100	1	2749140000
WS 10/6 M PLUS MC NE WS	600	2003780000
DEK 5/6 MM WS	600	2007120000
WS 8/6 MM WS	600	2007160000
DEK 5/6 PLUS MC NE WS	1000	1011320000
SIHA 3/G20	6.3 A 25	7921560000
SIHA 3/G20/LD 10-36V	25	7921570000
SIHA 3/G20/LD 35-70V	25	7921580000
SIHA 3/G20/LD 60-150V	25	7921590000
SIHA 3/G20/LD 140-250V	25	7921600000
TNST OR	20 A 50	2463540000
TNST	20 A 50	1833090000
BEST	50	1833100000
BEST/D	1 A 50	1878560000
BEST/DRBR	22 A 50	1878570000

Type	Qty.	Order No.
ZQV 4N/2	32 A 60	1527930000
ZQV 4N/10	32 A 20	1528090000
AEP 2T 4 FS	20	2817060000
AEB 35 SC/1	50	1991920000
AEB 35 SCL/1 VO	20	2661280000
ATPG 1.5-10 L	0.2 A 50	1991890000
ATPG 4 MHR	0.2 A 50	1991860000
SDIL 0,6X3,5X100	1	2749140000
WS 10/6 M PLUS MC NE WS	600	2003780000
DEK 5/6 MM WS	600	2007120000
WS 8/6 MM WS	600	2007160000
DEK 5/6 PLUS MC NE WS	1000	1011320000
SIHA 3/G20	6.3 A 25	7921560000
SIHA 3/G20/LD 10-36V	25	7921570000
SIHA 3/G20/LD 35-70V	25	7921580000
SIHA 3/G20/LD 60-150V	25	7921590000
SIHA 3/G20/LD 140-250V	25	7921600000
TNST OR	20 A 50	2463540000
TNST	20 A 50	1833090000
BEST	50	1833100000
BEST/D	1 A 50	1878560000
BEST/DRBR	22 A 50	1878570000



Spring connection with PUSH IN technology (A-Series)
Pluggable terminal blocks

Universal range

A

APGTB 1.5 FT 2C/1

1.5 mm²

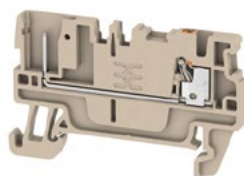

APGTB 1.5 PE 2C/1

1.5 mm²

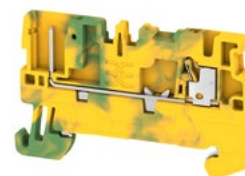

Width/Height/Depth	mm
max. current / max. cond. cross-section	A/mm ²
Max. clamping range	mm ²

3.5 x 55 x 33.5	
17.5 / 1.5	
0.14...1.5	

3.5 x 55 x 33.5	
/ 1.5	
0.14...1.5	

Technical data

Rated data	
Rated voltage of feed-through terminal	V
Rated current	A
for wire cross-section	mm ²
Rated impulse withstand voltage / Pollution severity	
Gauge to IEC 60947-1 / UL 94 flammability rating	
Number of operating cycles	
Approvals	
Clamped conductors (H05V/H07V)	
Solid / Stranded	mm ²
Flexible / Flexible with ferrule	mm ²
Stripping length / Blade size	mm/-

In accordance with IEC 60947-7-1

IEC	UL	CSA	EN 60079-7
500	300	300	
17.5	13	13	
1.5	AWG 26...14	AWG 26...14	
6 kV / 3			
A1 / V-0			

In accordance with IEC 60947-7-2

IEC	UL	CSA	EN 60079-7
500	300	300	
1.5	AWG 26...14	AWG 26...14	
6 kV / 3			
A1 / V-0			



Rated connection	
0.5...1.5 / 0.5...1.5	
0.5...1.5 / 0.5...1	
8 / 0.4 x 2.0 mm	



Rated connection	
0.5...1.5 / 0.5...1.5	
0.5...1.5 / 0.5...1	
8 / 0.4 x 2.0 mm	

Note

Ordering data

Version	
dark beige	
Blue	
Green/yellow	
Note	

Type	Qty.	Order No.
APGTB 1.5 FT 2C/1	50	2482160000
APGTB 1.5 FT 2C/1 BL	50	2482170000
Note		

Type	Qty.	Order No.
APGTB 1.5 PE 2C/1	50	2482200000
Note		

Accessories

Plug-in cross-connection	
2-pole	
10-pole	
End plate	
dark beige	
Blue	
End bracket	
dark beige, screwable	
dark beige, direct mounting	
Plug	
Screwdriver	
Standard	
Marking tags	

Type	Qty.	Order No.
ZQV 1.5N/2	17.5 A 60	1985410000
ZQV 1.5N/10	17.5 A 20	1985580000
AEP 2C 1.5	50	1552600000
AEP 2C 1.5 BL	50	1552610000
AEB 35 SC/1	50	1991920000
AEB 35 SCL/1 V0	20	2661280000
APG 1.5/1	17.5 A 50	2482340000
APG 1.5/10	17.5 A 20	2482430000
APG 1.5 MI	17.5 A 50	2482280000
APG 1.5 L	17.5 A 50	2482250000
APG 1.5 R	17.5 A 50	2482310000
SDS 0.4X2.0X60	1	2749260000
WS 10/3.5 PLUS MC NE WS	960	2003760000
DEK 5/3.5 MM WS	1000	2007100000
DEK 5/3.5 PLUS MC NE WS	1600	2003750000

Type	Qty.	Order No.
ZQV 1.5N/2	17.5 A 60	1985410000
ZQV 1.5N/10	17.5 A 20	1985580000
AEP 2C 1.5	50	1552600000
AEB 35 SC/1	50	1991920000
AEB 35 SCL/1 V0	20	2661280000
APG 1.5/1	17.5 A 50	2482340000
APG 1.5/10	17.5 A 20	2482430000
APG 1.5 MI	17.5 A 50	2482280000
APG 1.5 L	17.5 A 50	2482250000
APG 1.5 R	17.5 A 50	2482310000
SDS 0.4X2.0X60	1	2749260000
WS 10/3.5 PLUS MC NE WS	960	2003760000
DEK 5/3.5 MM WS	1000	2007100000
DEK 5/3.5 PLUS MC NE WS	1600	2003750000

For detailed information on other accessories and application in the online catalogue

APGTB 1.5 FT 3C/1

1.5 mm²

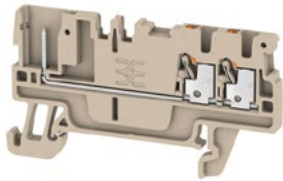

3.5 x 62 x 33.5
17.5 / 1.5
0.14...1.5



In accordance with IEC 60947-7-1

IEC	UL	CSA	EN 60079-7
500	300	300	
17.5	13	13	
1.5	AWG 26...14	AWG 26...14	
6 kV / 3			
A1 / V-0			



Rated connection

0.5...1.5 / 0.5...1.5
0.5...1.5 / 0.5...1
8 / 0.4 x 2.0 mm

Type	Qty.	Order No.
APGTB 1.5 FT 3C/1	50	2482180000
APGTB 1.5 FT 3C/1 BL	50	2482190000

Type	Qty.	Order No.
ZQV 1.5N/2	17.5 A 60	1985410000
ZQV 1.5N/10	17.5 A 20	1985580000
AEP 3C 1.5	50	1552620000
AEP 3C 1.5 BL	50	1552630000
AEB 35 SC/1	50	1991920000
AEB 35 SCL/1 VO	20	2661280000
APG 1.5/1	17.5 A 50	2482340000
APG 1.5/10	17.5 A 20	2482430000
APG 1.5 MI	17.5 A 50	2482280000
APG 1.5 L	17.5 A 50	2482250000
APG 1.5 R	17.5 A 50	2482310000
SDS 0.4X2.0X60	1	2749260000
WS 10/3.5 PLUS MC NE WS	960	2003760000
DEK 5/3.5 MM WS	1000	2007100000
DEK 5/3.5 PLUS MC NE WS	1600	2003750000

APGTB 1.5 FT PE 3C/1

1.5 mm²

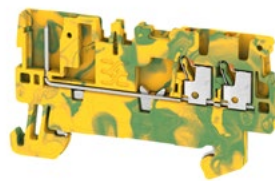

3.5 x 62 x 33.5
/ 1.5
0.14...1.5



In accordance with IEC 60947-7-2

IEC	UL	CSA	EN 60079-7
500	300	300	
1.5	AWG 26...14	AWG 26...14	
6 kV / 3			
A1 / V-0			



Rated connection

0.5...1.5 / 0.5...1.5
0.5...1.5 / 0.5...1
8 / 0.4 x 2.0 mm

Type	Qty.	Order No.
APGTB 1.5 PE 3C/1	50	2482230000

Type	Qty.	Order No.
ZQV 1.5N/2	17.5 A 60	1985410000
ZQV 1.5N/10	17.5 A 20	1985580000
AEP 3C 1.5	50	1552620000
AEB 35 SC/1	50	1991920000
AEB 35 SCL/1 VO	20	2661280000
APG 1.5/1	17.5 A 50	2482340000
APG 1.5/10	17.5 A 20	2482430000
APG 1.5 MI	17.5 A 50	2482280000
APG 1.5 L	17.5 A 50	2482250000
APG 1.5 R	17.5 A 50	2482310000
SDS 0.4X2.0X60	1	2749260000
WS 10/3.5 PLUS MC NE WS	960	2003760000
DEK 5/3.5 MM WS	1000	2007100000
DEK 5/3.5 PLUS MC NE WS	1600	2003750000

APGTB 1.5 FT 4C/2

1.5 mm²



3.5 x 80 x 33.5
17.5 / 1.5
0.14...1.5



In accordance with IEC 60947-7-1

IEC	UL	CSA	EN 60079-7
500	300	300	
17.5	13	13	
1.5	AWG 26...14	AWG 26...14	
6 kV / 3			
A1 / V-0			



Rated connection

0.5...1.5 / 0.5...1.5
0.5...1.5 / 0.5...1
8 / 0.4 x 2.0 mm

Type	Qty.	Order No.
APGTB 1.5 FT 4C/2	50	2482200000
APGTB 1.5 FT 4C/2 BL	50	2482210000

Type	Qty.	Order No.
ZQV 1.5N/2	17.5 A 60	1985410000
ZQV 1.5N/10	17.5 A 20	1985580000
AEP PGTB 1.5 4C/2	50	2482510000
AEP PGTB 1.5 4C/2 BL	50	2482520000
AEB 35 SC/1	50	1991920000
AEB 35 SCL/1 VO	20	2661280000
APG 1.5/1	17.5 A 50	2482340000
APG 1.5/10	17.5 A 20	2482430000
APG 1.5 MI	17.5 A 50	2482280000
APG 1.5 L	17.5 A 50	2482250000
APG 1.5 R	17.5 A 50	2482310000
SDS 0.4X2.0X60	1	2749260000
WS 10/3.5 PLUS MC NE WS	960	2003760000
DEK 5/3.5 MM WS	1000	2007100000
DEK 5/3.5 PLUS MC NE WS	1600	2003750000

Spring connection with PUSH IN technology (A-Series) Pluggable terminal blocks

Universal range

A

APGTB 1.5 PE 4C/2

1.5 mm²

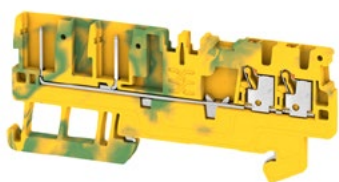

Width/Height/Depth	mm
max. current / max. cond. cross-section	-/mm ²
Max. clamping range	mm ²

3.5 x 80 x 33.5	
/ 1.5	
0.14...1.5	

Technical data

Rated data	
Rated voltage of feed-through terminal	V
Rated current	-
for wire cross-section	mm ²
Rated impulse withstand voltage / Pollution severity	
Gauge to IEC 60947-1 / UL 94 flammability rating	
Number of operating cycles	
Approvals	
Clamped conductors (H05V/H07V)	
Solid / Stranded	mm ²
Flexible / Flexible with ferrule	mm ²
Stripping length / Blade size	mm/-

Note

Ordering data

Version	
	dark beige
	Blue
	Green/yellow
Note	

Accessories

Plug-in cross-connection	
	2-pole
	10-pole
End plate	
	dark beige
	Blue
End bracket	
	dark beige, screwable
	dark beige, direct mounting
Plug	
Screwdriver	Standard
Marking tags	

For detailed information on other accessories and application in the online catalogue

APGTB 1.5 2T 4C/2

1.5 mm²

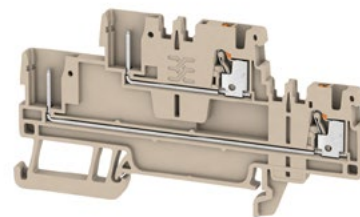

3.5 x 84.5 x 45	
17.5 / 1.5	
0.14...1.5	

In accordance with IEC 60947-7-1

IEC	UL	CSA	EN 60079-7
500	300	300	
17.5	13	13	
1.5	AWG 26...14	AWG 26...14	
		6 kV / 3	
		A1 / V-0	

Rated connection	
0.5...1.5 / 0.5...1.5	
0.5...1.5 / 0.5...1	
8 / 0.4 x 2.0 mm	

Note

Type	Qty.	Order No.
APGTB 1.5 2T 4C/2	50	2485840000
APGTB 1.5 2T 4C/2 BL	50	2485850000

Type	Qty.	Order No.
ZQV 1.5N/2	17.5 A 60	1985410000
ZQV 1.5N/10	17.5 A 20	1985580000
AEP 2T 1.5	20	2469420000
AEP 2T 1.5 BL	20	2471470000
AEB 35 SC/1	50	1991920000
AEB 35 SCL/1 VO	20	2661280000
APG 1.5/1	17.5 A 50	2482340000
APG 1.5/10	17.5 A 20	2482430000
APG 1.5 MI	17.5 A 50	2482280000
APG 1.5 L	17.5 A 50	2482250000
APG 1.5 R	17.5 A 50	2482310000
SDS 0.4X2.0X60	1	2749260000
WS 10/3.5 PLUS MC NE WS	960	2003760000
DEK 5/3.5 MM WS	1000	2007100000
DEK 5/3.5 PLUS MC NE WS	1600	2003750000
SNAPMARK 1.5	40	2682080000

APGTB 1.5 2T VL 4C/2

1.5 mm²

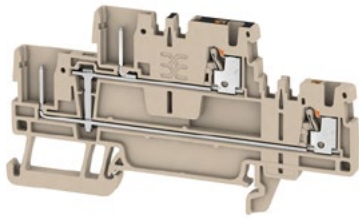

3.5 x 84.5 x 45
17.5 / 1.5
0.14...1.5



In accordance with IEC 60947-7-1

IEC	UL	CSA	EN 60079-7
500	300	300	
17.5	13	13	
1.5	AWG 26...14	AWG 26...14	
6 kV / 3			
A1 / V-0			



Rated connection

0.5...1.5 / 0.5...1.5
0.5...1.5 / 0.5...1
8 / 0.4 x 2.0 mm

APGTB 1.5 2T FT PE 4C/2

1.5 mm²

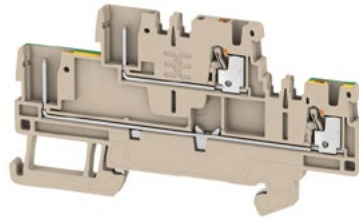

3.5 x 84.5 x 45
17.5 / 1.5
0.14...1.5

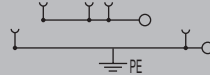

In accordance with IEC 60947-7-1

IEC	UL	CSA	EN 60079-7
500	300	300	
17.5	13	13	
1.5	AWG 26...14	AWG 26...14	
6 kV / 3			
A1 / V-0			



Rated connection

0.5...1.5 / 0.5...1.5
0.5...1.5 / 0.5...1
8 / 0.4 x 2.0 mm

APGTB 1.5 2T PE 4C/2

1.5 mm²

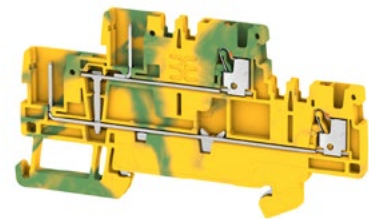

3.5 x 84.5 x 45
/ 1.5
0.14...1.5

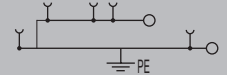

In accordance with IEC 60947-7-2

IEC	UL	CSA	EN 60079-7
500	300	300	
1.5	AWG 26...14	AWG 26...14	
6 kV / 3			
A1 / V-0			



Rated connection

0.5...1.5 / 0.5...1.5
0.5...1.5 / 0.5...1
8 / 0.4 x 2.0 mm

Type	Qty.	Order No.
APGTB 1.5 2T VL 4C/2	50	2485920000
APGTB 1.5 2T VL 4C/2 BL	50	2485930000

Type	Qty.	Order No.
APGTB 1.5 2T FT-PE 4C/2	50	2485860000

Type	Qty.	Order No.
APGTB 1.5 2T PE 4C/2	50	2485870000

Type	Qty.	Order No.
ZQV 1.5N/2	17.5 A 60	1985410000
ZQV 1.5N/10	17.5 A 20	1985580000
AEP 2T 1.5	20	2469420000
AEP 2T 1.5 BL	20	2471470000
AEB 35 SC/1	50	1991920000
AEB 35 SCL/1 VO	20	2661280000
APG 1.5/1	17.5 A 50	2482340000
APG 1.5/10	17.5 A 20	2482430000
APG 1.5 MI	17.5 A 50	2482280000
APG 1.5 L	17.5 A 50	2482250000
APG 1.5 R	17.5 A 50	2482310000
SDS 0.4X2.0X60	1	2749260000
WS 10/3.5 PLUS MC NE WS	960	2003760000
DEK 5/3.5 MM WS	1000	2007100000
DEK 5/3.5 PLUS MC NE WS	1600	2003750000
SNAPMARK 1.5	40	2682080000

Type	Qty.	Order No.
ZQV 1.5N/2	17.5 A 60	1985410000
ZQV 1.5N/10	17.5 A 20	1985580000
AEP 2T 1.5	20	2469420000
AEP 2T 1.5 BL	20	2471470000
AEB 35 SC/1	50	1991920000
AEB 35 SCL/1 VO	20	2661280000
APG 1.5/1	17.5 A 50	2482340000
APG 1.5/10	17.5 A 20	2482430000
APG 1.5 MI	17.5 A 50	2482280000
APG 1.5 L	17.5 A 50	2482250000
APG 1.5 R	17.5 A 50	2482310000
SDS 0.4X2.0X60	1	2749260000
WS 10/3.5 PLUS MC NE WS	960	2003760000
DEK 5/3.5 MM WS	1000	2007100000
DEK 5/3.5 PLUS MC NE WS	1600	2003750000
SNAPMARK 1.5	40	2682080000

Type	Qty.	Order No.
ZQV 1.5N/2	17.5 A 60	1985410000
ZQV 1.5N/10	17.5 A 20	1985580000
AEP 2T 1.5	20	2469420000
AEB 35 SC/1	50	1991920000
AEB 35 SCL/1 VO	20	2661280000
APG 1.5/1	17.5 A 50	2482340000
APG 1.5/10	17.5 A 20	2482430000
APG 1.5 MI	17.5 A 50	2482280000
APG 1.5 L	17.5 A 50	2482250000
APG 1.5 R	17.5 A 50	2482310000
SDS 0.4X2.0X60	1	2749260000
WS 10/3.5 PLUS MC NE WS	960	2003760000
DEK 5/3.5 MM WS	1000	2007100000
DEK 5/3.5 PLUS MC NE WS	1600	2003750000
SNAPMARK 1.5	40	2682080000



Spring connection with PUSH IN technology (A-Series)
Pluggable terminal blocks

APGTB 2.5 FT 2C/1

2.5 mm²



APGTB 2.5 PE 2C/1

2.5 mm²



Width/Height/Depth	mm
max. current / max. cond. cross-section	A/mm ²
Max. clamping range	mm ²

5.1 x 55 x 36.5	
24 / 4	
0.14...4	

5.1 x 54 x 36.5	
/ 4	
0.14...4	

Technical data

Rated data	
Rated voltage of feed-through terminal	V
Rated current	A
for wire cross-section	mm ²
Rated impulse withstand voltage / Pollution severity	
Gauge to IEC 60947-1 / UL 94 flammability rating	
Number of operating cycles	
Approvals	
Clamped conductors (H05V/H07V)	
Solid / Stranded	mm ²
Flexible / Flexible with ferrule	mm ²
Stripping length / Blade size	mm/-

In accordance with IEC 60947-7-1

IEC	UL	CSA	EN 60079-7
800	600	600	
24	20	20	
2.5	AWG 28...12	AWG 28...12	
8 kV / 3			
A3 / V-0			

In accordance with IEC 60947-7-2

IEC	UL	CSA	EN 60079-7
800	600	600	
2.5	AWG 28...12	AWG 28...12	
8 kV / 3			
A3 / V-0			



Rated connection	
0.5...2.5 / 0.5...4	
0.5...4 / 0.5...2.5	
10 / 0.6 x 3.5 mm	

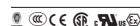

Rated connection	
0.5...2.5 / 0.5...4	
0.5...4 / 0.5...2.5	
10 / 0.6 x 3.5 mm	

Note

Ordering data

Version	
	dark beige
	Blue
	Green/yellow

Note

Type	Qty.	Order No.
APGTB 2.5 FT 2C/1	100	1513970000
APGTB 2.5 FT 2C/1 BL	100	1513990000

Type	Qty.	Order No.
APGTB 2.5 PE 2C/1	50	1513870000

Accessories

Plug-in cross-connection	
	2-pole
	10-pole

End plate	
	dark beige
	Blue

End bracket	
	dark beige, screwable
	dark beige, direct mounting

Plug	

Screwdriver	
	Standard

Marking tags	

Type	Qty.	Order No.
ZQV 2.5N/2	24 A 60	1527540000
ZQV 2.5N/10	24 A 20	1527690000
AEP 2C 2.5	50	1514400000
AEP 2C 2.5 BL	50	1514420000
AEB 35 SC/1	50	1991920000
AEB 35 SCL/1 V0	20	2661280000

APG 2.5/1	24 A 50	1513720000
APG 2.5/10	24 A 20	1513770000
APG 2.5 L	24 A 50	1513830000
APG 2.5 MI	24 A 50	1513880000
APG 2.5 R	24 A 50	1513940000

SDIL 0,6X3,5X100	1	2749140000
------------------	---	------------

DEK 5/5 PLUS MC NE WS	1000	1854490000
DEK 5/5 MM WS	800	2007110000
WS 8/5 MM WS	800	2007150000
WS 10/5 M PLUS MC NE WS	600	2003770000

Type	Qty.	Order No.
ZQV 2.5N/2	24 A 60	1527540000
ZQV 2.5N/10	24 A 20	1527690000
AEP 2C 2.5	50	1514400000
AEB 35 SC/1	50	1991920000
AEB 35 SCL/1 V0	20	2661280000

APG 2.5/1	24 A 50	1513720000
APG 2.5/10	24 A 20	1513770000
APG 2.5 L	24 A 50	1513830000
APG 2.5 MI	24 A 50	1513880000
APG 2.5 R	24 A 50	1513940000

SDIL 0,6X3,5X100	1	2749140000
------------------	---	------------

DEK 5/5 PLUS MC NE WS	1000	1854490000
DEK 5/5 MM WS	800	2007110000
WS 8/5 MM WS	800	2007150000
WS 10/5 M PLUS MC NE WS	600	2003770000

For detailed information on other accessories and application in the online catalogue

APGTB 2.5 FT 3C/1

2.5 mm²

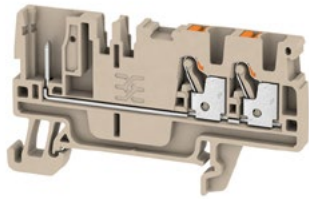

5.1 x 66.5 x 36.5
24 / 4
0.14...4



In accordance with IEC 60947-7-1

IEC	UL	CSA	EN 60079-7
800	600	600	
24	20	20	
2.5	AWG 28...12	AWG 28...12	
8 kV / 3			
A3 / V-0			



Rated connection

0.5...2.5 / 0.5...4
0.5...4 / 0.5...2.5
10 / 0.6 x 3.5 mm

APGTB 2.5 PE 3C/1

2.5 mm²

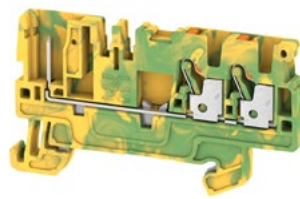

5.1 x 66.5 x 36.5
/ 4
0.14...4



In accordance with IEC 60947-7-2

IEC	UL	CSA	EN 60079-7
800	600	600	
2.5	AWG 28...12	AWG 28...12	
8 kV / 3			
A3 / V-0			



Rated connection

0.5...2.5 / 0.5...4
0.5...4 / 0.5...2.5
10 / 0.6 x 3.5 mm

APGTB 2.5 FT 4C/2

2.5 mm²

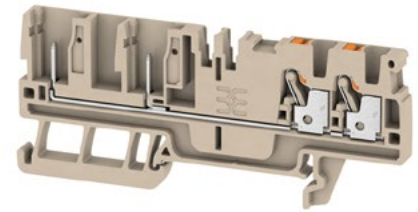

5.1 x 87 x 36.5
24 / 4
0.14...4



In accordance with IEC 60947-7-1

IEC	UL	CSA	EN 60079-7
800	600	600	
24	20	20	
2.5	AWG 28...12	AWG 28...12	
8 kV / 3			
A3 / V-0			



Rated connection

0.5...2.5 / 0.5...4
0.5...4 / 0.5...2.5
10 / 0.6 x 3.5 mm

Type	Qty.	Order No.
APGTB 2.5 FT 3C/1	50	1514000000
APGTB 2.5 FT 3C/1 BL	50	1514020000

Type	Qty.	Order No.
APGTB 2.5 PE 3C/1	50	1513890000

Type	Qty.	Order No.
APGTB 2.5 FT 4C/2	50	1514030000
APGTB 2.5 FT 4C/2 BL	50	1514040000

Type	Qty.	Order No.
ZQV 2.5N/2	24 A 60	1527540000
ZQV 2.5N/10	24 A 20	1527690000
AEP 3C 2.5	50	1521510000
AEP 3C 2.5 BL	50	1521520000
AEB 35 SC/1	50	1991920000
AEB 35 SCL/1 VO	20	2661280000
APG 2.5/1	24 A 50	1513720000
APG 2.5/10	24 A 20	1513770000
APG 2.5 L	24 A 50	1513830000
APG 2.5 MI	24 A 50	1513880000
APG 2.5 R	24 A 50	1513940000
SDIL 0,6X3,5X100	1	2749140000
DEK 5/5 PLUS MC NE WS	1000	1854490000
DEK 5/5 MM WS	800	2007110000
WS 8/5 MM WS	800	2007150000

Type	Qty.	Order No.
ZQV 2.5N/2	24 A 60	1527540000
ZQV 2.5N/10	24 A 20	1527690000
AEP 3C 2.5	50	1521510000
AEB 35 SC/1	50	1991920000
AEB 35 SCL/1 VO	20	2661280000
APG 2.5/1	24 A 50	1513720000
APG 2.5/10	24 A 20	1513770000
APG 2.5 L	24 A 50	1513830000
APG 2.5 MI	24 A 50	1513880000
APG 2.5 R	24 A 50	1513940000
SDIL 0,6X3,5X100	1	2749140000
DEK 5/5 PLUS MC NE WS	1000	1854490000
DEK 5/5 MM WS	800	2007110000
WS 8/5 MM WS	800	2007150000

Type	Qty.	Order No.
ZQV 2.5N/2	24 A 60	1527540000
ZQV 2.5N/10	24 A 20	1527690000
AEP PGTB 2.5 4C/2	50	1514450000
AEP PGTB 2.5 4C/2 BL	50	1514470000
AEB 35 SC/1	50	1991920000
AEB 35 SCL/1 VO	20	2661280000
APG 2.5/1	24 A 50	1513720000
APG 2.5/10	24 A 20	1513770000
APG 2.5 L	24 A 50	1513830000
APG 2.5 MI	24 A 50	1513880000
APG 2.5 R	24 A 50	1513940000
SDIL 0,6X3,5X100	1	2749140000
DEK 5/5 PLUS MC NE WS	1000	1854490000
DEK 5/5 MM WS	800	2007110000
WS 8/5 MM WS	800	2007150000



Spring connection with PUSH IN technology (A-Series) Pluggable terminal blocks

Universal range

A

APGTB 2.5 PE 4C/2

2.5 mm²

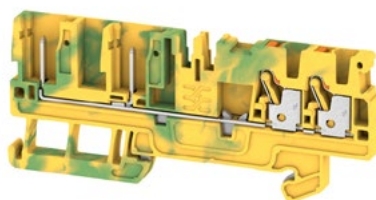

5.1 x 87 x 36.5
/ 4
0.14...4

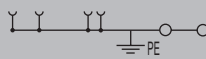

APGTB 2.5 2T 4C/2

2.5 mm²

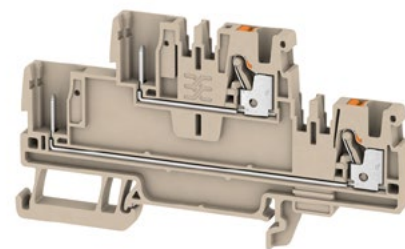

5.1 x 91 x 50.5
24 / 4
0.14...4

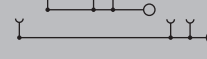

Width/Height/Depth mm
max. current / max. cond. cross-section -/mm²
Max. clamping range mm²

Technical data

Rated data	
Rated voltage of feed-through terminal	V
Rated current	-
for wire cross-section	mm ²
Rated impulse withstand voltage / Pollution severity	
Gauge to IEC 60947-1 / UL 94 flammability rating	
Number of operating cycles	
Approvals	
Clamped conductors (H05V/H07V)	
Solid / Stranded	mm ²
Flexible / Flexible with ferrule	mm ²
Stripping length / Blade size	mm/-

Note

Ordering data

Version	
	dark beige
	Blue
	Green/yellow

Note

Accessories

Plug-in cross-connection	
	2-pole
	10-pole
End plate	
	dark beige
	blue
End bracket	
	dark beige, screwable
	dark beige, direct mounting
Plug	
Screwdriver	
	Standard
Marking tags	

For detailed information on other accessories and application in the online catalogue

In accordance with IEC 60947-7-2

IEC	UL	CSA	EN 60079-7
800	600	600	
2.5	AWG 28...12	AWG 28...12	
	8 kV / 3		
	A3 / V-0		



Rated connection	
0.5...2.5 / 0.5...4	
0.5...4 / 0.5...2.5	
10 / 0.6 x 3.5 mm	

Type	Qty.	Order No.
APGTB 2.5 PE 4C/2	50	1513920000

Type	Qty.	Order No.
ZQV 2.5N/2	24 A 60	1527540000
ZQV 2.5N/10	24 A 20	1527690000
AEP PGTB 2.5 4C/2	50	1514450000
AEB 35 SC/1	50	1991920000
AEB 35 SCL/1 V0	20	2661280000
APG 2.5/1	24 A 50	1513720000
APG 2.5/10	24 A 20	1513770000
APG 2.5 L	24 A 50	1513830000
APG 2.5 MI	24 A 50	1513880000
APG 2.5 R	24 A 50	1513940000
SDIL 0,6X3,5X100	1	2749140000
DEK 5/5 PLUS MC NE WS	1000	1854490000
DEK 5/5 MM WS	800	2007110000
WS 8/5 MM WS	800	2007150000

In accordance with IEC 60947-7-1

IEC	UL	CSA	EN 60079-7
800	600	600	
24	20	20	
2.5	AWG 28...12	AWG 28...12	
	8 kV / 3		
	A3 / V-0		



Rated connection	
0.5...2.5 / 0.5...4	
0.5...4 / 0.5...2.5	
10 / 0.6 x 3.5 mm	

Type	Qty.	Order No.
APGTB 2.5 2T 4C/2	50	1548060000
APGTB 2.5 2T 4C/2 BL	50	1548070000

Type	Qty.	Order No.
ZQV 2.5N/2	24 A 60	1527540000
ZQV 2.5N/10	24 A 20	1527690000
AEP 2T 2.5	20	1547690000
AEP 2T 2.5 BL	20	1547700000
AEB 35 SC/1	50	1991920000
AEB 35 SCL/1 V0	20	2661280000
APG 2.5/1	24 A 50	1513720000
APG 2.5/10	24 A 20	1513770000
APG 2.5 L	24 A 50	1513830000
APG 2.5 MI	24 A 50	1513880000
APG 2.5 R	24 A 50	1513940000
SDIL 0,6X3,5X100	1	2749140000
DEK 5/5 PLUS MC NE WS	1000	1854490000
DEK 5/5 MM WS	800	2007110000
WS 8/5 MM WS	800	2007150000
WS 10/5 M PLUS MC NE WS	600	2003770000
SNAPMARK I	50	1805880000

APGTB 2.5 2T VL 4C/2

2.5 mm²

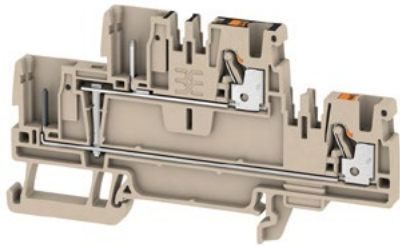

5.1 x 91 x 50.5
24 / 4
0.14...4



In accordance with IEC 60947-7-1

IEC	UL	CSA	EN 60079-7
800	600	600	
24	20	20	
2.5	AWG 28...12	AWG 28...12	
8 kV / 3			
A3 / V-0			



Rated connection

0.5...2.5 / 0.5...4
0.5...4 / 0.5...2.5
10 / 0.6 x 3.5 mm

APGTB 2.5 2T FT-PE 4C/2

2.5 mm²

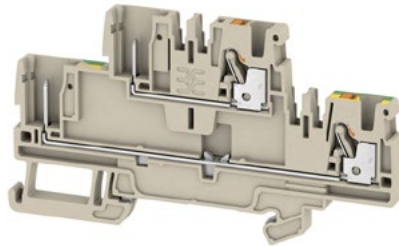

5.1 x 91 x 50.5
24 / 4
0.14...4

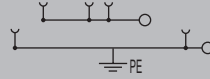

In accordance with IEC 60947-7-1

IEC	UL	CSA	EN 60079-7
800	600		
24	20		
2.5	AWG 28...12		
8 kV / 3			
A3 / V-0			



Rated connection

0.5...2.5 / 0.5...4
0.5...4 / 0.5...2.5
10 / 0.6 x 3.5 mm

APGTB 2.5 2T PE 4C/2

2.5 mm²

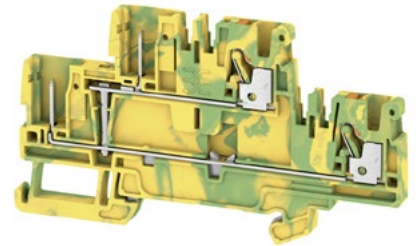

5.1 x 91 x 50.5
/ 4
0.14...4

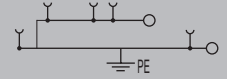

In accordance with IEC 60947-7-2

IEC	UL	CSA	EN 60079-7
800	600	600	
2.5	AWG 28...12	AWG 28...12	
8 kV / 3			
A3 / V-0			



Rated connection

0.5...2.5 / 0.5...4
0.5...4 / 0.5...2.5
10 / 0.6 x 3.5 mm

Type	Qty.	Order No.
APGTB 2.5 2T VL 4C/2	50	1548140000
APGTB 2.5 2T VL 4C/2 BL	50	1548150000

Type	Qty.	Order No.
APGTB 2.5 2T FT-PE 4C/2	50	1548130000

Type	Qty.	Order No.
APGTB 2.5 2T PE 4C/2	50	1548160000

Type	Qty.	Order No.
ZQV 2.5N/2	24 A 60	1527540000
ZQV 2.5N/10	24 A 20	1527690000
AEP 2T 2.5	20	1547690000
AEP 2T 2.5 BL	20	1547700000
AEB 35 SC/1	50	1991920000
AEB 35 SCL/1 VO	20	2661280000
APG 2.5/1	24 A 50	1513720000
APG 2.5/10	24 A 20	1513770000
APG 2.5 L	24 A 50	1513830000
APG 2.5 MI	24 A 50	1513880000
APG 2.5 R	24 A 50	1513940000
SDIL 0,6X3,5X100	1	2749140000
DEK 5/5 PLUS MC NE WS	1000	1854490000
DEK 5/5 MM WS	800	2007110000
WS 8/5 MM WS	800	2007150000
WS 10/5 M PLUS MC NE WS	600	2003770000
SNAPMARK I	50	1805880000

Type	Qty.	Order No.
ZQV 2.5N/2	24 A 60	1527540000
ZQV 2.5N/10	24 A 20	1527690000
AEP 2T 2.5	20	1547690000
AEP 2T 2.5 BL	20	1547700000
AEB 35 SC/1	50	1991920000
AEB 35 SCL/1 VO	20	2661280000
APG 2.5/1	24 A 50	1513720000
APG 2.5/10	24 A 20	1513770000
APG 2.5 L	24 A 50	1513830000
APG 2.5 MI	24 A 50	1513880000
APG 2.5 R	24 A 50	1513940000
SDIL 0,6X3,5X100	1	2749140000
DEK 5/5 PLUS MC NE WS	1000	1854490000
DEK 5/5 MM WS	800	2007110000
WS 8/5 MM WS	800	2007150000
WS 10/5 M PLUS MC NE WS	600	2003770000
SNAPMARK I	50	1805880000

Type	Qty.	Order No.
ZQV 2.5N/2	24 A 60	1527540000
ZQV 2.5N/10	24 A 20	1527690000
AEP 2T 2.5	20	1547690000
AEB 35 SC/1	50	1991920000
AEB 35 SCL/1 VO	20	2661280000
APG 2.5/10	24 A 20	1513770000
APG 2.5 L	24 A 50	1513830000
APG 2.5 MI	24 A 50	1513880000
APG 2.5 R	24 A 50	1513940000
SDIL 0,6X3,5X100	1	2749140000
DEK 5/5 PLUS MC NE WS	1000	1854490000
DEK 5/5 MM WS	800	2007110000
WS 8/5 MM WS	800	2007150000
WS 10/5 M PLUS MC NE WS	600	2003770000
SNAPMARK I	50	1805880000



Spring connection with PUSH IN technology (A-Series)

Pluggable terminal blocks

APGTB 4 FT 2C/1

4 mm²

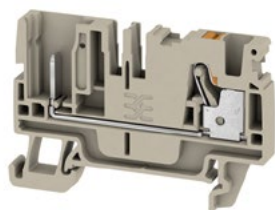

APGTB 4 PE 2C/1

4 mm²

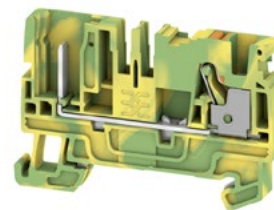

Width/Height/Depth	mm
max. current / max. cond. cross-section	A/mm ²
Max. clamping range	mm ²

6.1 x 59.5 x 39.5	
32 / 6	
0.14...6	

6.1 x 59.5 x 39.5	
/ 6	
0.14...6	

Technical data

Rated data	
Rated voltage of feed-through terminal	V
Rated current	A
for wire cross-section	mm ²
Rated impulse withstand voltage / Pollution severity	
Gauge to IEC 60947-1 / UL 94 flammability rating	
Number of operating cycles	
Approvals	
Clamped conductors (H05V/H07V)	
Solid / Stranded	mm ²
Flexible / Flexible with ferrule	mm ²
Stripping length / Blade size	mm/-

In accordance with IEC 60947-7-1

IEC	UL	CSA	EN 60079-7
800	600	600	
32	30	30	
4	AWG 26...10	AWG 26...10	
	8 kV / 3		
	A4 / V-0		

In accordance with IEC 60947-7-2

IEC	UL	CSA	EN 60079-7
800	600	600	
4	AWG 26...10	AWG 26...10	
	8 kV / 3		
	A4 / V-0		

CE

Rated connection	
0.5...4 / 0.5...6	
0.5...6 / 0.5...4	
12 / 0.6 x 3.5 mm	

CE

Rated connection	
0.5...4 / 0.5...6	
0.5...6 / 0.5...4	
12 / 0.6 x 3.5 mm	

Note

Ordering data

Version	
	dark beige
	Blue
	Green/yellow

Note

Type	Qty.	Order No.
APGTB 4 FT 2C/1	100	2540050000
APGTB 4 FT 2C/1 BL	100	2540060000

Type	Qty.	Order No.
APGTB 4 PE 2C/1	50	2540110000

Accessories

Plug-in cross-connection	
	2-pole
	10-pole
End plate	
	dark beige
	Blue
End bracket	
	dark beige, screwable
	dark beige, direct mounting
Plug	
Screwdriver	Standard
Marking tags	

Type	Qty.	Order No.
ZQV 4N/2	32 A 60	1527930000
ZQV 4N/10	32 A 20	1528090000
AEP 2C 4	50	2051680000
AEP 2C 4 BL	50	2051690000
AEB 35 SC/1	50	1991920000
AEB 35 SCL/1 VO	20	2661280000
APG 4/1	32 A 50	2540460000
APG 4/10	32 A 20	2540550000
APG 4 MI	32 A 50	2540580000
APG 4 L	32 A 50	2540360000
APG 4 R	32 A 50	2540610000
SDIL 0,6X3,5X100	1	2749140000
WS 10/6 M PLUS MC NE WS	600	2003780000
DEK 5/6 MM WS	600	2007120000
WS 8/6 MM WS	600	2007160000
DEK 5/6 PLUS MC NE WS	1000	1011320000

Type	Qty.	Order No.
ZQV 4N/2	32 A 60	1527930000
ZQV 4N/10	32 A 20	1528090000
AEP 2C 4	50	2051680000
AEP 2C 4 BL	50	2051690000
AEB 35 SC/1	50	1991920000
AEB 35 SCL/1 VO	20	2661280000
APG 4/1	32 A 50	2540460000
APG 4/10	32 A 20	2540550000
APG 4 MI	32 A 50	2540580000
APG 4 L	32 A 50	2540360000
APG 4 R	32 A 50	2540610000
SDIL 0,6X3,5X100	1	2749140000
WS 10/6 M PLUS MC NE WS	600	2003780000
DEK 5/6 MM WS	600	2007120000
WS 8/6 MM WS	600	2007160000
DEK 5/6 PLUS MC NE WS	1000	1011320000

For detailed information on other accessories and application in the online catalogue

APGTB 4 FT 3C/1

4 mm²

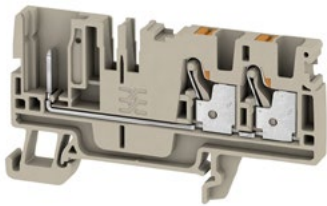

6.1 x 72 x 39.5
32 / 6
0.14...6



In accordance with IEC 60947-7-1

IEC	UL	CSA	EN 60079-7
800	600	600	
32	30	30	
4	AWG 26...10	AWG 26...10	
8 kV / 3			
A4 / V-0			

CE

Rated connection

0.5...4 / 0.5...6

0.5...6 / 0.5...4

12 / 0.6 x 3.5 mm

APGTB 4 PE 3C/1

4 mm²

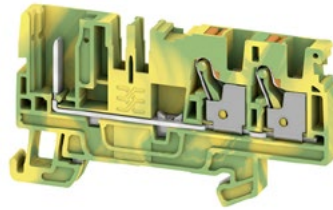

6.1 x 72 x 39.5
/ 6
0.14...6



In accordance with IEC 60947-7-2

IEC	UL	CSA	EN 60079-7
800	600	600	
32	30	30	
4	AWG 26...10	AWG 26...10	
8 kV / 3			
A4 / V-0			

CE

Rated connection

0.5...4 / 0.5...6

0.5...6 / 0.5...4

12 / 0.6 x 3.5 mm

APGTB 4 FT 4C/2

4 mm²

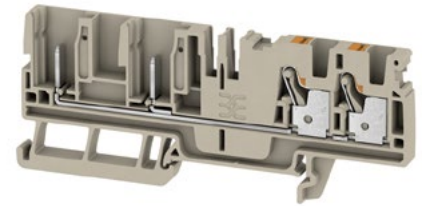

6.1 x 98 x 39.5
32 / 6
0.14...6



In accordance with IEC 60947-7-1

IEC	UL	CSA	EN 60079-7
800	600	600	
32	30	30	
4	AWG 26...10	AWG 26...10	
8 kV / 3			
A4 / V-0			

CE

Rated connection

0.5...4 / 0.5...6

0.5...6 / 0.5...4

12 / 0.6 x 3.5 mm

Type	Qty.	Order No.
APGTB 4 FT 3C/1	50	2540070000
APGTB 4 FT 3C/1 BL	50	2540080000

Type	Qty.	Order No.
APGTB 4 PE 3C/1	50	2540170000

Type	Qty.	Order No.
APGTB 4 FT 4C/2	50	2540090000
APGTB 4 FT 4C/2 BL	50	2540100000

Type	Qty.	Order No.	
ZQV 4N/2	32 A	60	1527930000
ZQV 4N/10	32 A	20	1528090000
AEP 3C 4	20	2051720000	
AEP 3C 4 BL	20	2051880000	
AEB 35 SC/1	50	1991920000	
AEB 35 SCL/1 VO	20	2661280000	
APG 4/1	32 A	50	2540460000
APG 4/10	32 A	20	2540550000
APG 4 MI	32 A	50	2540580000
APG 4 L	32 A	50	2540360000
APG 4 R	32 A	50	2540610000
SDIL 0,6X3,5X100	1	2749140000	
WS 10/6 M PLUS MC NE WS	600	2003780000	
DEK 5/6 MM WS	600	2007120000	
WS 8/6 MM WS	600	2007160000	
DEK 5/6 PLUS MC NE WS	1000	1011320000	

Type	Qty.	Order No.	
ZQV 4N/2	32 A	60	1527930000
ZQV 4N/10	32 A	20	1528090000
AEP 3C 4	20	2051720000	
AEP 3C 4 BL	20	2051880000	
AEB 35 SC/1	50	1991920000	
AEB 35 SCL/1 VO	20	2661280000	
APG 4/1	32 A	50	2540460000
APG 4/10	32 A	20	2540550000
APG 4 MI	32 A	50	2540580000
APG 4 L	32 A	50	2540360000
APG 4 R	32 A	50	2540610000
SDIL 0,6X3,5X100	1	2749140000	
WS 10/6 M PLUS MC NE WS	600	2003780000	
DEK 5/6 MM WS	600	2007120000	
WS 8/6 MM WS	600	2007160000	
DEK 5/6 PLUS MC NE WS	1000	1011320000	

Type	Qty.	Order No.	
ZQV 4N/2	32 A	60	1527930000
ZQV 4N/10	32 A	20	1528090000
AEP PGTB 4 4C/2	20	2540210000	
AEP PGTB 4 4C/2 BL	20	2540280000	
AEB 35 SC/1	50	1991920000	
AEB 35 SCL/1 VO	20	2661280000	
APG 4/1	32 A	50	2540460000
APG 4/10	32 A	20	2540550000
APG 4 MI	32 A	50	2540580000
APG 4 L	32 A	50	2540360000
APG 4 R	32 A	50	2540610000
SDIL 0,6X3,5X100	1	2749140000	
WS 10/6 M PLUS MC NE WS	600	2003780000	
DEK 5/6 MM WS	600	2007120000	
WS 8/6 MM WS	600	2007160000	
DEK 5/6 PLUS MC NE WS	1000	1011320000	



Spring connection with PUSH IN technology (A-Series)
Pluggable terminal blocks

Universal range

A

APGTB 4 PE 4C/2

4 mm²

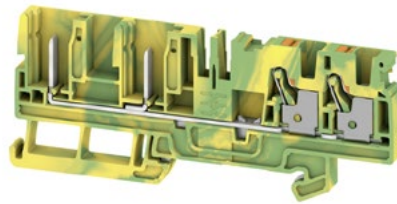

6.1 x 98 x 39.5
 / 6
0.14...6

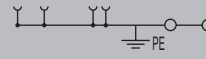

APGTB 4 2T 4C/2

4 mm²

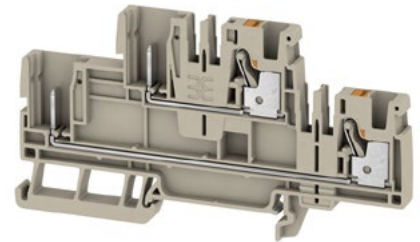

6.1 x 100 x 53.5
32 / 6
0.14...6



Width/Height/Depth	mm
max. current / max. cond. cross-section	-/mm ²
Max. clamping range	mm ²

Technical data

Rated data	
Rated voltage of feed-through terminal	V
Rated current	-
for wire cross-section	mm ²
Rated impulse withstand voltage / Pollution severity	
Gauge to IEC 60947-1 / UL 94 flammability rating	
Number of operating cycles	
Approvals	
Clamped conductors (H05V/H07V)	
Solid / Stranded	mm ²
Flexible / Flexible with ferrule	mm ²
Stripping length / Blade size	mm/-
Note	

Ordering data

Version	
	dark beige
	Blue
	Green/yellow
Note	

Accessories

Plug-in cross-connection	
	2-pole
	10-pole
End plate	
	dark beige
	Blue
End bracket	
	dark beige, screwable
	dark beige, direct mounting
Plug	
Screwdriver	
	Standard
Marking tags	

In accordance with IEC 60947-7-2

IEC	UL	CSA	EN 60079-7
800	600	600	
4	AWG 26...10	AWG 26...10	
	8 kV / 3		
	A4 / V-0		

CE

Rated connection	
	0.5...4 / 0.5...6
	0.5...6 / 0.5...4
	12 / 0.6 x 3.5 mm
Note	

Type	Qty.	Order No.
APGTB 4 PE 4C/2	50	2540180000
Note		

Type	Qty.	Order No.
ZQV 4N/2	32 A 60	1527930000
ZQV 4N/10	32 A 20	1528090000
AEP PGTB 4 4C/2	20	2540210000
AEP PGTB 4 4C/2 BL	20	2540280000
AEB 35 SC/1	50	1991920000
AEB 35 SCL/1 V0	20	2661280000
APG 4/1	32 A 50	2540460000
APG 4/10	32 A 20	2540550000
APG 4 MI	32 A 50	2540580000
APG 4 L	32 A 50	2540360000
APG 4 R	32 A 50	2540610000
SDIL 0,6X3,5X100	1	2749140000
WS 10/6 M PLUS MC NE WS	600	2003780000
DEK 5/6 MM WS	600	2007120000
WS 8/6 MM WS	600	2007160000
DEK 5/6 PLUS MC NE WS	1000	1011320000
Note		

In accordance with IEC 60947-7-1

IEC	UL	CSA	EN 60079-7
800	600	600	
32	30	30	
4	AWG 26...10	AWG 26...10	
	8 kV / 3		
	A4 / V-0		

CE

Rated connection	
	0.5...4 / 0.5...6
	0.5...6 / 0.5...4
	12 / 0.6 x 3.5 mm
Note	

Type	Qty.	Order No.
APGTB 4 2T 4C/2	50	2540230000
APGTB 4 2T 4C/2 BL	50	2540250000
Note		

Type	Qty.	Order No.
ZQV 4N/2	32 A 60	1527930000
ZQV 4N/10	32 A 20	1528090000
AEP 2T 4	20	2540000000
AEP 2T 4 BL	20	2540010000
AEB 35 SC/1	50	1991920000
AEB 35 SCL/1 V0	20	2661280000
APG 4/1	32 A 50	2540460000
APG 4/10	32 A 20	2540550000
APG 4 MI	32 A 50	2540580000
APG 4 L	32 A 50	2540360000
APG 4 R	32 A 50	2540610000
SDIL 0,6X3,5X100	1	2749140000
WS 10/6 M PLUS MC NE WS	600	2003780000
DEK 5/6 MM WS	600	2007120000
WS 8/6 MM WS	600	2007160000
DEK 5/6 PLUS MC NE WS	1000	1011320000
SNAPMARK I	50	1805880000
Note		

For detailed information on other accessories and application in the online catalogue

APGTB 4 2T VL 4C/2

4 mm²

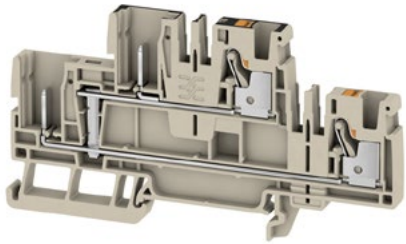

6.1 x 100 x 53.5
32 / 6
0.14...6

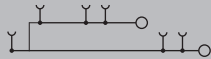

In accordance with IEC 60947-7-1

IEC	UL	CSA	EN 60079-7
800	600	600	
32	30	30	
4	AWG 26...10	AWG 26...10	
8 kV / 3			
A4 / V-0			

CE

Rated connection

0.5...4 / 0.5...6
0.5...6 / 0.5...4
12 / 0.6 x 3.5 mm

Type	Qty.	Order No.
APGTB 4 2T VL 4C/2	50	2540260000
APGTB 4 2T VL 4C/2 BL	50	2540270000

Type	Qty.	Order No.
ZQV 4N/2	32 A 60	1527930000
ZQV 4N/10	32 A 20	1528090000
AEP 2T 4	20	2540000000
AEP 2T 4 BL	20	2540010000
AEB 35 SC/1	50	1991920000
AEB 35 SCL/1 VO	20	2661280000
APG 4/1	32 A 50	2540460000
APG 4/10	32 A 20	2540550000
APG 4 MI	32 A 50	2540580000
APG 4 L	32 A 50	2540360000
APG 4 R	32 A 50	2540610000
SDIL 0,6X3,5X100	1	2749140000
WS 10/6 M PLUS MC NE WS	600	2003780000
DEK 5/6 MM WS	600	2007120000
WS 8/6 MM WS	600	2007160000
DEK 5/6 PLUS MC NE WS	1000	1011320000
SNAPMARK I	50	1805880000

APGTB 4 2T FT-PE 4C/2

4 mm²

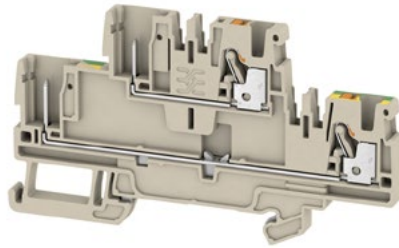

6.1 x 100 x 53.5
32 / 6
0.14...6

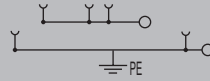

In accordance with IEC 60947-7-1

IEC	UL	CSA	EN 60079-7
800	600	600	
32	30	30	
4	AWG 26...10	AWG 26...10	
8 kV / 3			
A4 / V-0			

CE

Rated connection

0.5...4 / 0.5...6
0.5...6 / 0.5...4
12 / 0.6 x 3.5 mm

Type	Qty.	Order No.
APGTB 4 2T FT-PE 4C/2	50	2540290000

Type	Qty.	Order No.
ZQV 4N/2	32 A 60	1527930000
ZQV 4N/10	32 A 20	1528090000
AEP 2T 4	20	2540000000
AEP 2T 4 BL	20	2540010000
AEB 35 SC/1	50	1991920000
AEB 35 SCL/1 VO	20	2661280000
APG 4/1	32 A 50	2540460000
APG 4/10	32 A 20	2540550000
APG 4 MI	32 A 50	2540580000
APG 4 L	32 A 50	2540360000
APG 4 R	32 A 50	2540610000
SDIL 0,6X3,5X100	1	2749140000
WS 10/6 M PLUS MC NE WS	600	2003780000
DEK 5/6 MM WS	600	2007120000
WS 8/6 MM WS	600	2007160000
DEK 5/6 PLUS MC NE WS	1000	1011320000
SNAPMARK I	50	1805880000

APGTB 4 2T PE 4C/2

4 mm²

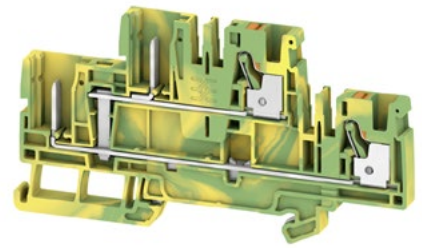

6.1 x 100 x 53.5
/ 6
0.14...6

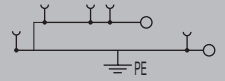

In accordance with IEC 60947-7-2

IEC	UL	CSA	EN 60079-7
800	600	600	
4	AWG 26...10	AWG 26...10	
8 kV / 3			
A4 / V-0			

CE

Rated connection

0.5...4 / 0.5...6
0.5...6 / 0.5...4
12 / 0.6 x 3.5 mm

Type	Qty.	Order No.
APGTB 4 2T PE 4C/2	50	2540300000

Type	Qty.	Order No.
ZQV 4N/2	32 A 60	1527930000
ZQV 4N/10	32 A 20	1528090000
AEP 2T 4	20	2540000000
AEP 2T 4 BL	20	2540010000
AEB 35 SC/1	50	1991920000
AEB 35 SCL/1 VO	20	2661280000
APG 4/1	32 A 50	2540460000
APG 4/10	32 A 20	2540550000
APG 4 MI	32 A 50	2540580000
APG 4 L	32 A 50	2540360000
APG 4 R	32 A 50	2540610000
SDIL 0,6X3,5X100	1	2749140000
WS 10/6 M PLUS MC NE WS	600	2003780000
DEK 5/6 MM WS	600	2007120000
WS 8/6 MM WS	600	2007160000
DEK 5/6 PLUS MC NE WS	1000	1011320000
SNAPMARK I	50	1805880000



Spring connection with PUSH IN technology (A-Series)
Pluggable terminal blocks

APG 1.5...

1.5 mm²



APG 2.5...

2.5 mm²



Width/Height/Depth	mm
max. current / max. cond. cross-section	A/mm ²
Max. clamping range	mm ²

3.5 x 14 x 31.15
17.5 / 1.5
0.14...1.5

5.1 x 16.5 x 42.5
24 / 2.5
0.14...2.5

Technical data

Rated data	
Rated voltage	-
Max. voltage of clamp support & pluggable system	-
Rated current	A
for wire cross-section	mm ²
Rated impulse withstand voltage / Pollution severity	
Gauge to IEC 60947-1 / UL 94 flammability rating	
Approvals	
Clamped conductors (H05V/H07V)	
Solid / Stranded	mm ²
Flexible / Flexible with ferrule	mm ²
Stripping length / Blade size	mm/-
Note	

In accordance with IEC 60947-7-1

IEC	UL	CSA	EN 60079-7
500	300	300	
17.5	13	13	
1.5	AWG 26...14	AWG 26...14	
6 kV / 3			
A1 / V-0			
Rated connection		Plug-in connection	
0.5...1.5 / 0.5...1.5			
0.5...1.5 / 0.5...1			
10 / 0.4 x 2.0 mm			

In accordance with IEC 60947-7-1

IEC	UL	CSA	EN 60079-7
800	600	600	
24	20	20	
2.5	AWG 28...12	AWG 28...12	
8 kV / 3			
A3 / V-0			
Rated connection		Plug-in connection	
0.5...2.5 / 0.5...2.5			
0.5...2.5 / 0.5...2.5			
10 / 0.6 x 3.5 mm			

Ordering data

Version	
1-pole	
2-pole	
3-pole	
4-pole	
5-pole	
6-pole	
7-pole	
8-pole	
9-pole	
10-pole	
	4-poles/3x beige, 1x green
	3-poles/1xbeige, 1x blue, 1x green
	5-poles/3xbeige, 1x blue, 1x green
Note	

Type	Qty.	Order No.
APG 1.5/1	50	2482340000
APG 1.5/2	25	2482350000
APG 1.5/3	25	2482360000
APG 1.5/4	25	2482370000
APG 1.5/5	25	2482380000
APG 1.5/6	25	2482390000
APG 1.5/7	25	2482400000
APG 1.5/8	20	2482410000
APG 1.5/9	20	2482420000
APG 1.5/10	20	2482430000
APG 1.5/3-BG-BL-GN	25	2482460000
APG 1.5/5-3BG-BL-GN	25	2482440000

Type	Qty.	Order No.
APG 2.5/1	50	1513720000
APG 2.5/2	25	1513640000
APG 2.5/3	25	1513650000
APG 2.5/4	25	1513670000
APG 2.5/5	25	1513680000
APG 2.5/6	25	1513690000
APG 2.5/7	25	1513700000
APG 2.5/8	20	1513730000
APG 2.5/9	20	1513740000
APG 2.5/10	20	1513770000
APG 2.5/3-BG-BL-GN	25	1513820000
APG 2.5/5-3BG-BL-GN	25	1513780000

Accessories

End plate	dark beige
Coding	
Cover	
Interlock	
Strain relief	
Marking tags	

Type	Qty.	Order No.
MVC APG 1.5	50	2485980000
APGCE	50	1514490000
APGPC 1.5	50	2482530000
APGLE 1.5	25	2482720000
APGSR 1.5	25	2482730000
APGSR 1.5 - 4P	25	2482740000
APGSR 1.5 - 8P	25	2482750000
WS 10/3.5 PLUS MC NE WS	960	2003760000
DEK 5/3.5 MM WS	1000	2007100000
DEK 5/3.5 PLUS MC NE WS	1600	2003750000

Type	Qty.	Order No.
MVC APG 2.5	50	2035590000
APGCE	50	1514490000
APGPC 2.5	50	1514500000
APGLE 2.5/4	25	2457570000
APGSR 2.5/4	25	2457580000
APGSR 2.5/4 - 4P	25	2457590000
APGSR 2.5/4 - 8P	25	2457600000
DEK 5/5 PLUS MC NE WS	1000	1854490000
WS 10/5 M MC NE WS	720	1792000000
WS 8/5 MM WS	800	2007150000

For detailed information on other accessories and application in the online catalogue

APG 4...

4 mm²



6.1 x 19 x 50.95
32 / 4
0.14...4

In accordance with IEC 60947-7-1

IEC	UL	CSA	EN 60079-7
800	600	600	
32	30	30	
4	AWG 26...10	AWG 26...10	
	8 kV / 3		
	A4 / V-0		



Rated connection	Plug-in connection
0.5...4 / 0.5...4	
0.5...4 / 0.5...4	
10 / 0.6 x 3.5 mm	

Type	Qty.	Order No.
APG 4/1	50	2540460000
APG 4/2	25	2540470000
APG 4/3	25	2540480000
APG 4/4	25	2540490000
APG 4/5	25	2540500000
APG 4/6	25	2540510000
APG 4/7	25	2540520000
APG 4/8	20	2540530000
APG 4/9	20	2540540000
APG 4/10	20	2540550000
APG 4/4-3BG-GN	25	2540440000
APG 4/3-BG-BL-GN	25	2540450000
APG 4/5-3BG-BL-GN	25	2540430000

Type	Qty.	Order No.
MCV APG 4	50	2540800000
APGCE	50	1514490000
APGPC 4	50	2540960000
APGLE 2.5/4	25	2457570000
APGSR 2.5/4	25	2457580000
APGSR 2.5/4 - 4P	25	2457590000
APGSR 2.5/4 - 8P	25	2457600000
WS 10/6 M MC NE WS	600	1818400000
DEK 5/6 MM WS	600	2007120000
DEK 5/6 PLUS MC NE WS	1000	1011320000
WS 8/6 MM WS	600	2007160000

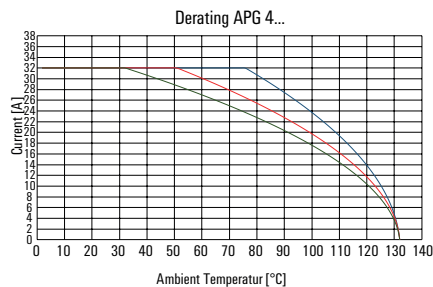
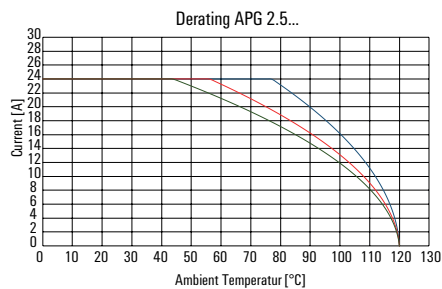
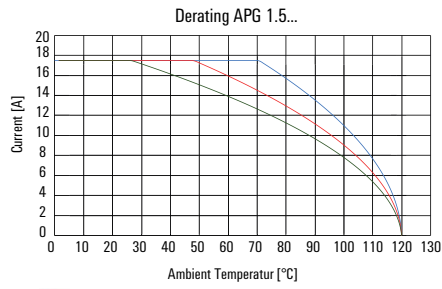

Spring connection with PUSH IN technology (A-Series)

Pluggable terminal blocks

APG 1.5...

1.5 mm²



APG 2.5...

2.5 mm²



Width/Height/Depth	mm
max. current / max. cond. cross-section	A/mm ²
Max. clamping range	mm ²

35 x 14 x 31.15
17.5 / 1.5
0.14...1.5

51 x 42.5 x 16.5
24 / 2.5
0.14...2.5

Technical data

Rated data	
Rated voltage	-
Max. voltage of clamp support & pluggable system	-
Rated current	A
for wire cross-section	mm ²
Rated impulse withstand voltage / Pollution severity	
Gauge to IEC 60947-1 / UL 94 flammability rating	
Approvals	
Clamped conductors (H05V/H07V)	
Solid / Stranded	mm ²
Flexible / Flexible with ferrule	mm ²
Stripping length / Blade size	mm/-

In accordance with IEC 60947-7-1

IEC	UL	CSA	EN 60079-7
500			
17.5			
1.5			
	6 kV / 3		
	A1 / V-0		

In accordance with IEC 60947-7-1

IEC	UL	CSA	EN 60079-7
800			
24			
2.5			
	8 kV / 3		
	A3 / V-0		

Rated connection	Plug-in connection
0.5...1.5 / 0.5...1.5	
0.5...1.5 / 0.5...1.5	
10 / 0.4 x 2.0 mm	

Rated connection	Plug-in connection
0.5...2.5 / 0.5...2.5	
0.5...2.5 / 0.5...2.5	
10 / 0.6 x 3.5 mm	

Note

Ordering data

Version	
	1-pole
	3-poles/2x beige, 1x green
	4-poles/3x beige, 1x green
	5-poles/4x beige, 1x green
	6-poles/5x beige, 1x green
	7-poles/6x beige, 1x green
	8-poles/7x beige, 1x green
	9-poles/8x beige, 1x green

Note

Type	Qty.	Order No.
APG 1.5/3-2BG-GN	25	2719740000
APG 1.5/4-3BG-GN	25	2482450000
APG 1.5/5-4BG-GN	25	2719770000
APG 1.5/6-5BG-GN	25	2719780000
APG 1.5/7-6BG-GN	25	2719800000
APG 1.5/8-7BG-GN	20	2719810000
APG 1.5/10-9BG-GN	20	2719830000

Type	Qty.	Order No.
APG 2.5/3-2BG-GN	25	2712740000
APG 2.5/4-3BG-GN	25	1513790000
APG 2.5/5-4BG-GN	25	2712760000
APG 2.5/6-5BG-GN	25	2712770000
APG 2.5/7-6BG-GN	25	2712780000
APG 2.5/8-7BG-GN	20	2712790000
APG 2.5/10-9BG-GN	20	2712810000

Accessories

End plate	dark beige
Coding	
Cover	
Interlock	
Strain relief	
Marking tags	

Type	Qty.	Order No.
MCV APG 1.5	50	2485980000
APGCE	50	1514490000
APGPC 1.5	50	2482530000
APGLE 1.5	25	2482720000
APGSR 1.5	25	2482730000
APGSR 1.5 - 4P	25	2482740000
APGSR 1.5 - 8P	25	2482750000
WS 10/3.5 PLUS MC NE WS	960	2003760000
DEK 5/3.5 MM WS	1000	2007100000
DEK 5/3.5 PLUS MC NE WS	1600	2003750000

Type	Qty.	Order No.
MCV APG 2.5	50	2035590000
APGCE	50	1514490000
APGPC 2.5	50	1514500000
APGLE 2.5/4	25	2457570000
APGSR 2.5/4	25	2457580000
APGSR 2.5/4 - 4P	25	2457590000
APGSR 2.5/4 - 8P	25	2457600000
DEK 5/5 PLUS MC NE WS	1000	1854490000
WS 10/5 M MC NE WS	720	1792000000
WS 8/5 MM WS	800	2007150000

For detailed information on other accessories and application in the online catalogue



Derating APG 1.5...

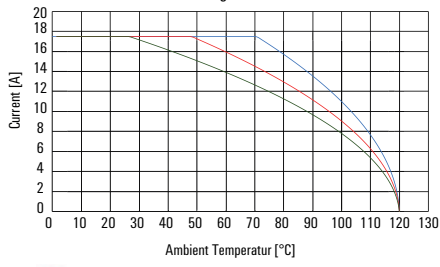

Derating APG 2.5...

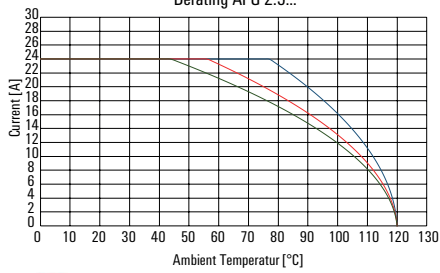

Spring connection with PUSH IN technology (A-Series) Pluggable terminal blocks – Accessories

Single plates for individual assembly

The individual plates increase flexibility by providing a solution for every task. The plug-in connector is assembled directly on-site in line with application requirements. Each individual plate is available in green (GN) and beige (BE).

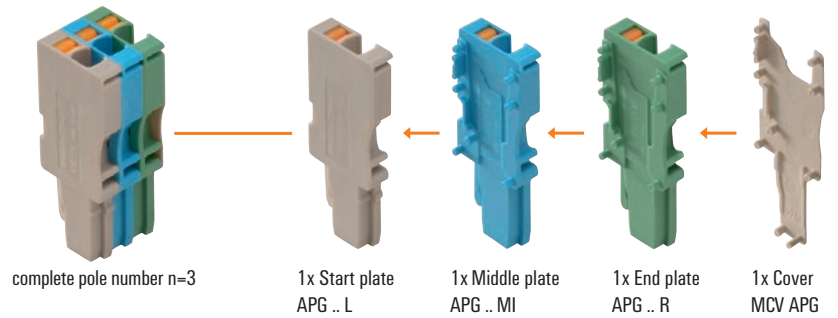

A

Plug

- Single plates, plug APG 1.5 L
- Marking option

APG 1.5



APG 2.5



APG 4



Ordering data	
Single plates	
Start plate	
Middle plate	
End plate	
Cover	
Note	

Type	Qty.	Order No.
APG 1.5 L	50	2482250000
APG 1.5 L BL	50	2482260000
APG 1.5 L GN	50	2482270000
APG 1.5 MI	50	2482280000
APG 1.5 MI BL	50	2482290000
APG 1.5 MI GN	50	2482300000
APG 1.5 R	50	2482310000
APG 1.5 R BL	50	2482320000
APG 1.5 R GN	50	2482330000
MCV APG 1.5	50	2485980000

Type	Qty.	Order No.
APG 2.5 L	50	1513830000
APG 2.5 L BL	50	1513840000
APG 2.5 L GN	50	1513850000
APG 2.5 MI	50	1513880000
APG 2.5 MI BL	50	1513900000
APG 2.5 MI GN	50	1513930000
APG 2.5 R	50	1513940000
APG 2.5 R BL	50	1513950000
APG 2.5 R GN	50	1513980000
MCV APG 2.5	50	2035590000

Type	Qty.	Order No.
APG 4 L	50	2540360000
APG 4 L BL	50	2540560000
APG 4 L GN	50	2540570000
APG 4 MI	50	2540580000
APG 4 MI BL	50	2540590000
APG 4 MI GN	50	2540600000
APG 4 R	50	2540610000
APG 4 R BL	50	2540620000
APG 4 R GN	50	2540630000
MCV APG 4	50	2540800000

Strain relief

- APGSR Strain relief transmits mechanical forces to the plastic housing and protects the contact point

APGSR

Strain reliefs



Application



Ordering data	
1.5 mm ²	
1.5 mm ²	
1.5 mm ²	
2.5 mm ² / 4 mm ²	
2.5 mm ² / 4 mm ²	
2.5 mm ² / 4 mm ²	
Note	

Type	Qty.	Order No.
APGSR 1.5	25	2482730000
APGSR 1.5 - 4P	25	2482740000
APGSR 1.5 - 8P	25	2482750000
APGSR 2.5/4	25	2457580000
APGSR 2.5/4 - 4P	25	2457590000
APGSR 2.5/4 - 8P	25	2457600000



Protective cover

- APGPC finger guard, also protects the contact point from dirt

Ordering data

1.5 mm²
2.5 mm²
4.0 mm²

Note

APGPC

Protective cover

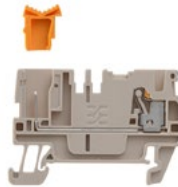

Type	Qty.	Order No.
APGPC 1.5	50	2482530000
APGPC 2.5	50	1514500000
APGPC 4	50	2540960000

Application

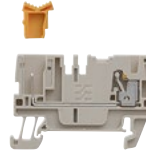

Coding elements

- For specific coding of the plug-in stations
- Protection against accidental mistake ensures process reliability

Ordering data

2.5 mm²

Note

APGCE

Coding elements



Type	Qty.	Order No.
APGCE	50	1514490000

Application



Locking elements

- APGLE to interlock with the terminal block
- APGLE interlock, plug - socket

Ordering data

1.5 mm²
2.5 mm² / 4 mm²

Note

APGLE

Locking element



Type	Qty.	Order No.
APGLE 1.5	25	2482720000
APGLE 2.5/4	25	2457570000

Application



PUSH IN terminal blocks with electronic components

Klippon® Connect A2T 2.5 EM

In industrial control panels, the smallest electronic components often have to be integrated to protect sensitive electronics, to connect components, to visualise operating states, and much more. Furthermore, maximum flexibility is required for the individual design of circuits.

Our terminal blocks with integrated electronic components provide a space-saving way of integrating important functions into circuits. The standard portfolio includes terminals with integrated diodes, resistors, and LEDs. In addition, specific components can be selected and soldered into the terminal body. This allows Klippon® Connect terminals with PUSH IN technology to be used extremely flexibly for a wide range of switching tasks.

Your special advantages:

- Maximum flexibility due to designs with and without integrated electronic components
- Highest security for components against voltage peaks and overvoltage
- Individual application possibilities thanks to numerous contact points for the integration of customer-specific electronic components
- Thanks to the contour uniformity, a combination with standard double level terminal blocks is possible

Alternative product solutions

The multifunctional disconnection areas allow the insertion of fuse holders (SIHA) or component plugs (BEST). This allows test-disconnect terminals to be converted to fuse terminals or to terminal blocks with electronic components.

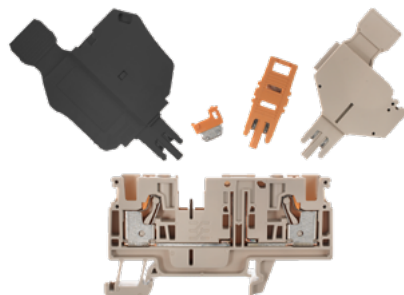

Individual application possibilities

Electronic components can be integrated into the different versions of the basic modular terminal block in accordance with the specific application. Numerous, easily accessible contact points allow the components to be soldered in.

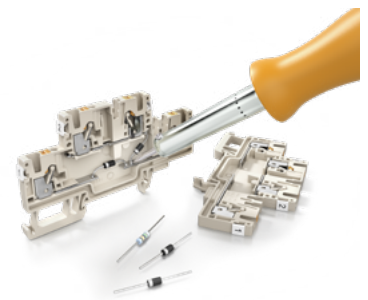

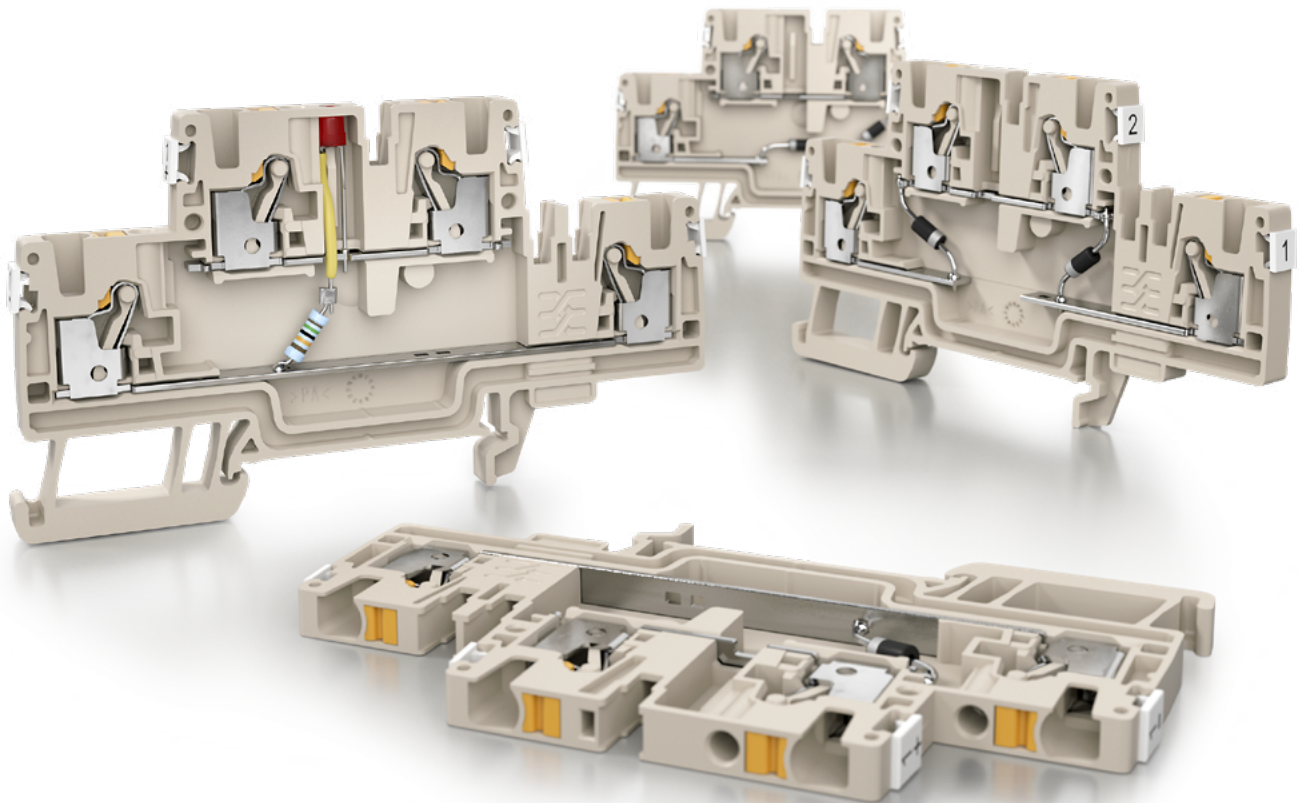

Flexible control cabinet integration

The design of the A2T 2.5 EM has the same contours as the standard double-level terminals of the A-series. Accessories such as the end plate can be adopted and potentials can be multiplied via the cross-connection channel.

Maximum protection of components

Integrated blocking diodes protect components against reverse currents or resistances. Voltage peaks or overvoltages can thus be effectively counteracted.

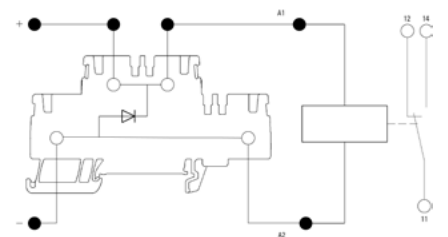

Spring connection with PUSH IN technology (A-Series)

Terminal blocks with electronic components

Universal range

A

A2T 2.5 EM1 D/0

2.5 mm²

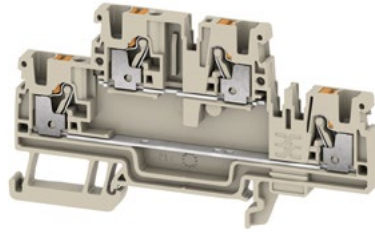

A2T 2.5 EM2 D/0

2.5 mm²

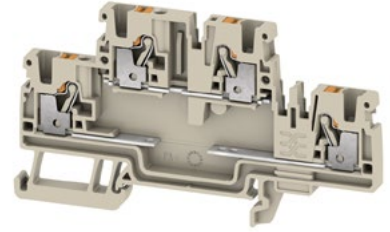

Width/Height/Depth	mm
max. current / max. cond. cross-section	A/mm ²
Max. clamping range	mm ²

5.1 x 90 x 50.5	
0.5 / 4	
0.14...4	

5.1 x 90 x 50.5	
0.5 / 4	
0.14...4	

Technical data

Rated data	
Rated voltage of feed-through terminal	V
Rated current	A
for wire cross-section	mm ²
Rated impulse withstand voltage / Pollution severity	
Gauge to IEC 60947-1 / UL 94 flammability rating	

In accordance with IEC 60947-7-1

IEC	UL	CSA	EN 60079-7
500	300		
10	10		
2.5	AWG 28...12		
/ 3			
A3 / V-0			

In accordance with IEC 60947-7-1

IEC	UL	CSA	EN 60079-7
500	300		
10	10		
2.5	AWG 28...12		
/ 3			
A3 / V-0			

Component 1
Approvals

Clamped conductors (H05V/H07V)	
Solid / Stranded	mm ²
Flexible / Flexible with ferrule	mm ²
Stripping length / Blade size	mm/-

CE

Rated connection	
0.5...2.5 / 0.5...4	
0.5...4 / 0.5...2.5	
10 / 0.6 x 3.5 mm	

CE

Rated connection	
0.5...2.5 / 0.5...4	
0.5...4 / 0.5...2.5	
10 / 0.6 x 3.5 mm	

Component diode	
Type diode	
Forward current	
Reverse voltage	
Forward voltage	

Component LED	
Colour	
Voltage, min.	
Voltage, max.	
Current	

Component resistor	
Resistance	
Power loss	
Tolerance (%)	

Note

Ordering data

Version	
dark beige, 1 A diode	
dark beige, 3 A diode	
End plate	

Note

Type	Qty.	Order No.
A2T 2.5 EM1 D/0	50	2704330000

Type	Qty.	Order No.
A2T 2.5 EM2 D/0	50	2704360000

Accessories

Plug-in cross-connection	
2-pole	
10-pole	

End plate	
dark beige	

End bracket	
dark beige, screwable	
dark beige, direct mounting	

Test plug

Screwdriver	
Standard	

Marking tags

Type	Qty.	Order No.
ZQV 2.5N/2	24 A 60	1527540000
ZQV 2.5N/10	24 A 20	1527690000

AEP 2T 2.5	
	20 1547690000

AEB 35 SC/1	
	50 1991920000
AEB 35 SCL/1 V0	
	20 2661280000

PS 2.0 MC	
	20 0310000000

SDIL 0,6X3,5X100	
	1 2749140000

DEK 5/5 PLUS MC NE WS	
	1000 1854490000
DEK 5/5 MM WS	
	800 2007110000
WS 8/5 MM WS	
	800 2007150000
SNAPMARK I	
	50 1805880000

Type	Qty.	Order No.
ZQV 2.5N/2	24 A 60	1527540000
ZQV 2.5N/10	24 A 20	1527690000

AEP 2T 2.5	
	20 1547690000

AEB 35 SC/1	
	50 1991920000
AEB 35 SCL/1 V0	
	20 2661280000

PS 2.0 MC	
	20 0310000000

SDIL 0,6X3,5X100	
	1 2749140000

DEK 5/5 PLUS MC NE WS	
	1000 1854490000
DEK 5/5 MM WS	
	800 2007110000
WS 8/5 MM WS	
	800 2007150000
SNAPMARK I	
	50 1805880000

For detailed information on other accessories and application in the online catalogue

A2T 2.5 EM3 D/0

2.5 mm²

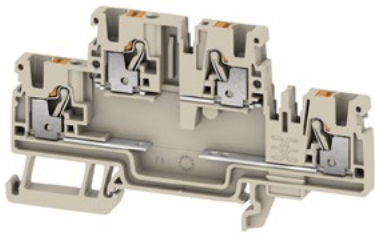

5.1 x 90 x 50.5
0.5 / 4
0.14...4

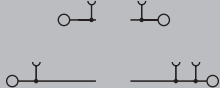

In accordance with IEC 60947-7-1

IEC	UL	CSA	EN 60079-7
500	300		
	10		
2.5	AWG 28...12		
	/ 3		
	A3 / V-0		

CE

Rated connection
0.5...2.5 / 0.5...4
0.5...4 / 0.5...2.5
10 / 0.6 x 3.5 mm

A2T 2.5 EM1 D/1

2.5 mm²

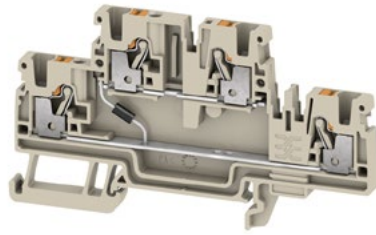

5.1 x 90 x 50.5
0.5 / 4
0.14...4

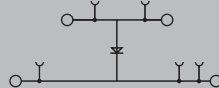

In accordance with IEC 60947-7-1

IEC	UL	CSA	EN 60079-7
500	24	24	
0.5	1	1	
2.5	AWG 28...12	AWG 28...12	
	/ 3		
	A3 / V-0		
	1 N 4007 /		

CE

Rated connection
0.5...2.5 / 0.5...4
0.5...4 / 0.5...2.5
10 / 0.6 x 3.5 mm

1N4007
1A
1300V
0.7V

A2T 2.5 EM1 D/2

2.5 mm²

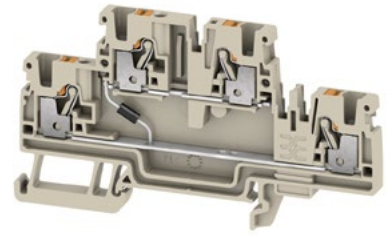

5.1 x 90 x 50.5
0.5 / 4
0.14...4

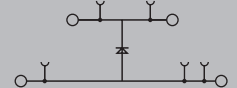

In accordance with IEC 60947-7-1

IEC	UL	CSA	EN 60079-7
500	24	24	
0.5	1	1	
2.5	AWG 28...12	AWG 28...12	
	/ 3		
	A3 / V-0		
	1 N 4007 /		

CE

Rated connection
0.5...2.5 / 0.5...4
0.5...4 / 0.5...2.5
10 / 0.6 x 3.5 mm

1N4007
1A
1300V
0.7V

Type	Qty.	Order No.
A2T 2.5 EM3 D/0	50	2704340000

Type	Qty.	Order No.
A2T 2.5 EM1 D/1	50	2704370000
A2T 2.5 EM1 D3/1	50	2820630000

Type	Qty.	Order No.
A2T 2.5 EM1 D/2	50	2704380000
A2T 2.5 EM1 D3/2	50	2820640000

Type	Qty.	Order No.
ZQV 2.5N/2	24 A 60	1527540000
ZQV 2.5N/10	24 A 20	1527690000
AEP 2T 2.5	20	1547690000
AEB 35 SC/1	50	1991920000
AEB 35 SCL/1 VO	20	2661280000
PS 2.0 MC	20	0310000000
SDIL 0,6X3,5X100	1	2749140000
DEK 5/5 PLUS MC NE WS	1000	1854490000
DEK 5/5 MM WS	800	2007110000
WS 8/5 MM WS	800	2007150000
SNAPMARK I	50	1805880000

Type	Qty.	Order No.
ZQV 2.5N/2	24 A 60	1527540000
ZQV 2.5N/10	24 A 20	1527690000
AEP 2T 2.5	20	1547690000
AEB 35 SC/1	50	1991920000
AEB 35 SCL/1 VO	20	2661280000
PS 2.0 MC	20	0310000000
SDIL 0,6X3,5X100	1	2749140000
DEK 5/5 PLUS MC NE WS	1000	1854490000
DEK 5/5 MM WS	800	2007110000
WS 8/5 MM WS	800	2007150000
SNAPMARK I	50	1805880000

Type	Qty.	Order No.
ZQV 2.5N/2	24 A 60	1527540000
ZQV 2.5N/10	24 A 20	1527690000
AEP 2T 2.5	20	1547690000
AEB 35 SC/1	50	1991920000
AEB 35 SCL/1 VO	20	2661280000
PS 2.0 MC	20	0310000000
SDIL 0,6X3,5X100	1	2749140000
DEK 5/5 PLUS MC NE WS	1000	1854490000
DEK 5/5 MM WS	800	2007110000
WS 8/5 MM WS	800	2007150000
SNAPMARK I	50	1805880000

Spring connection with PUSH IN technology (A-Series)
Terminal blocks with electronic components

Universal range

A

A2T 2.5 EM2 D/5

2.5 mm²

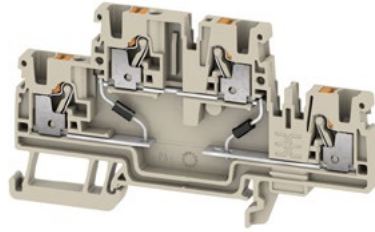

A2T 2.5 EM2 D/6

2.5 mm²

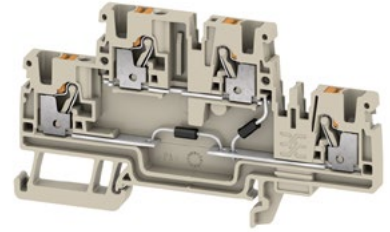

Width/Height/Depth	mm
max. current / max. cond. cross-section	A/mm ²
Max. clamping range	mm ²

5.1 x 90 x 50.5	
0.5 / 4	
0.14...4	

5.1 x 90 x 50.5	
0.5 / 4	
0.14...4	

Technical data

Rated data	
Rated voltage of feed-through terminal	V
Rated current	A
for wire cross-section	mm ²
Rated impulse withstand voltage / Pollution severity	
Gauge to IEC 60947-1 / UL 94 flammability rating	
Component 1	
Approvals	

In accordance with IEC 60947-7-1

IEC	UL	CSA	EN 60079-7
500	24	24	
0.5	1	1	
2.5	AWG 28...12	AWG 28...12	
/ 3			
A3 / V-0			
1 N 4007 /			

In accordance with IEC 60947-7-1

IEC	UL	CSA	EN 60079-7
500	24	24	
0.5	1	1	
2.5	AWG 28...12	AWG 28...12	
/ 3			
A3 / V-0			
1 N 4007 /			

Clamped conductors (H05V/H07V)

Solid / Stranded	mm ²
Flexible / Flexible with ferrule	mm ²
Stripping length / Blade size	mm/-

CE

Rated connection

0.5...2.5 / 0.5...4
0.5...4 / 0.5...2.5
10 / 0.6 x 3.5 mm

CE

Rated connection

0.5...2.5 / 0.5...4
0.5...4 / 0.5...2.5
10 / 0.6 x 3.5 mm

Component diode

Type diode	
Forward current	
Reverse voltage	
Forward voltage	

1N4007
1A
1300V
0.7V

1N4007
1A
1300V
0.7V

Component LED

Colour	
Voltage, min.	
Voltage, max.	
Current	

Component resistor

Resistance	
Power loss	
Tolerance (%)	

Note

Ordering data

Version	
	dark beige, 1 A diode
	dark beige, 3 A diode
	End plate

Type	Qty.	Order No.
A2T 2.5 EM2 D/5	50	2704390000

Type	Qty.	Order No.
A2T 2.5 EM2 D/6	50	2704400000

Note

Accessories

Plug-in cross-connection	
	2-pole
	10-pole

Type	Qty.	Order No.
ZQV 2.5N/2	24 A 60	1527540000
ZQV 2.5N/10	24 A 20	1527690000

Type	Qty.	Order No.
ZQV 2.5N/2	24 A 60	1527540000
ZQV 2.5N/10	24 A 20	1527690000

End plate

	dark beige
--	------------

AEP 2T 2.5	20	1547690000
------------	----	------------

AEP 2T 2.5	20	1547690000
------------	----	------------

End bracket

	dark beige, screwable
	dark beige, direct mounting

AEB 35 SC/1	50	1991920000
AEB 35 SCL/1 V0	20	2661280000

AEB 35 SC/1	50	1991920000
AEB 35 SCL/1 V0	20	2661280000

Test plug

--	--

PS 2.0 MC	20	0310000000
-----------	----	------------

PS 2.0 MC	20	0310000000
-----------	----	------------

Screwdriver

	Standard
--	----------

SDIL 0,6X3,5X100	1	2749140000
------------------	---	------------

SDIL 0,6X3,5X100	1	2749140000
------------------	---	------------

Marking tags

DEK 5/5 PLUS MC NE WS	1000	1854490000
DEK 5/5 MM WS	800	2007110000
WS 8/5 MM WS	800	2007150000
SNAPMARK I	50	1805880000

DEK 5/5 PLUS MC NE WS	1000	1854490000
DEK 5/5 MM WS	800	2007110000
WS 8/5 MM WS	800	2007150000
SNAPMARK I	50	1805880000

For detailed information on other accessories and application in the online catalogue

Efficient assembly of terminal blocks

Klippon® Automated RailAssembler – effective time saving in control cabinet building

Value-added processes must be faster, more precise and more economical, especially in times of full order books and a growing lack of specialists. This particular applies to control cabinet construction. Digitalisation and automation are important factors for increasing efficiency.

The Klippon® Automated RailAssembler, in combination with the Weidmüller Configurator (WMC) software, enables the fully automatic assembly of terminal blocks. By using the automated system the commissioning, allocation and positioning of individual terminals is no longer necessary. Time savings of up to 60% can be achieved during the assembly process - and even more when considering the unmanned operation of up to 7 hours.

Special features:

- Up to 60 % time saving in terminal block assembly (or significantly more considering the unmanned operation of up to 7 hours)
- Avoidance of incorrect assembly thanks to data consistency between eCAD programs and Weidmüller Configurator (WMC)
- Easy handling due to universal magazines

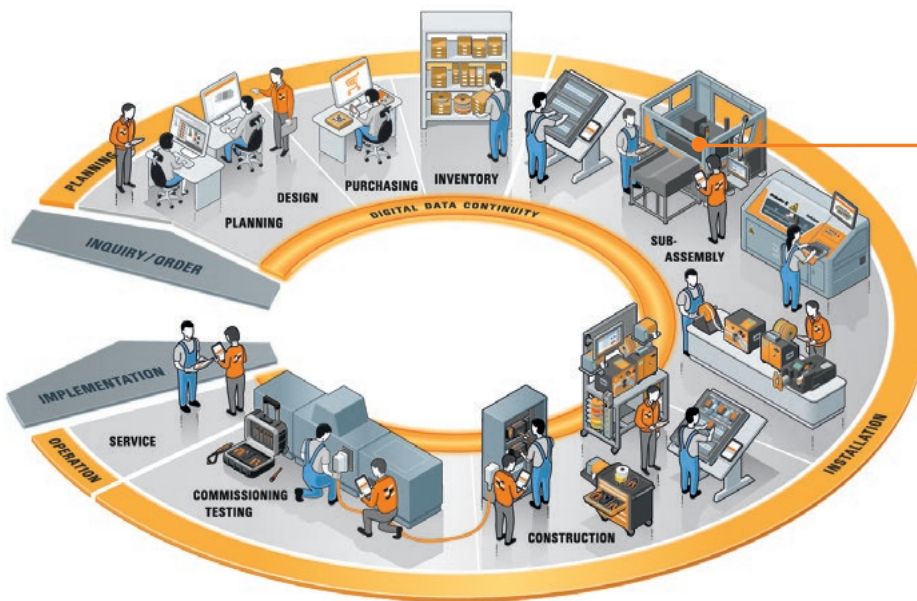

With Weidmüller, you have a powerful partner at your side who supports you with optimally coordinated solutions for your workshop in all phases. Based on many years of practical experience in all aspects of control cabinet construction, we offer you a comprehensive portfolio with which you can effectively accelerate your processes and increase your quality.

Discover your optimisation potential now:
www.weidmueller.com/workplace

Time savings up to
60%*

* or significantly more considering the unmanned operation

With the Klippon® Automated RailAssembler the commissioning, assigning and positioning, snapping on and inspecting the individual terminal blocks are obsolete.

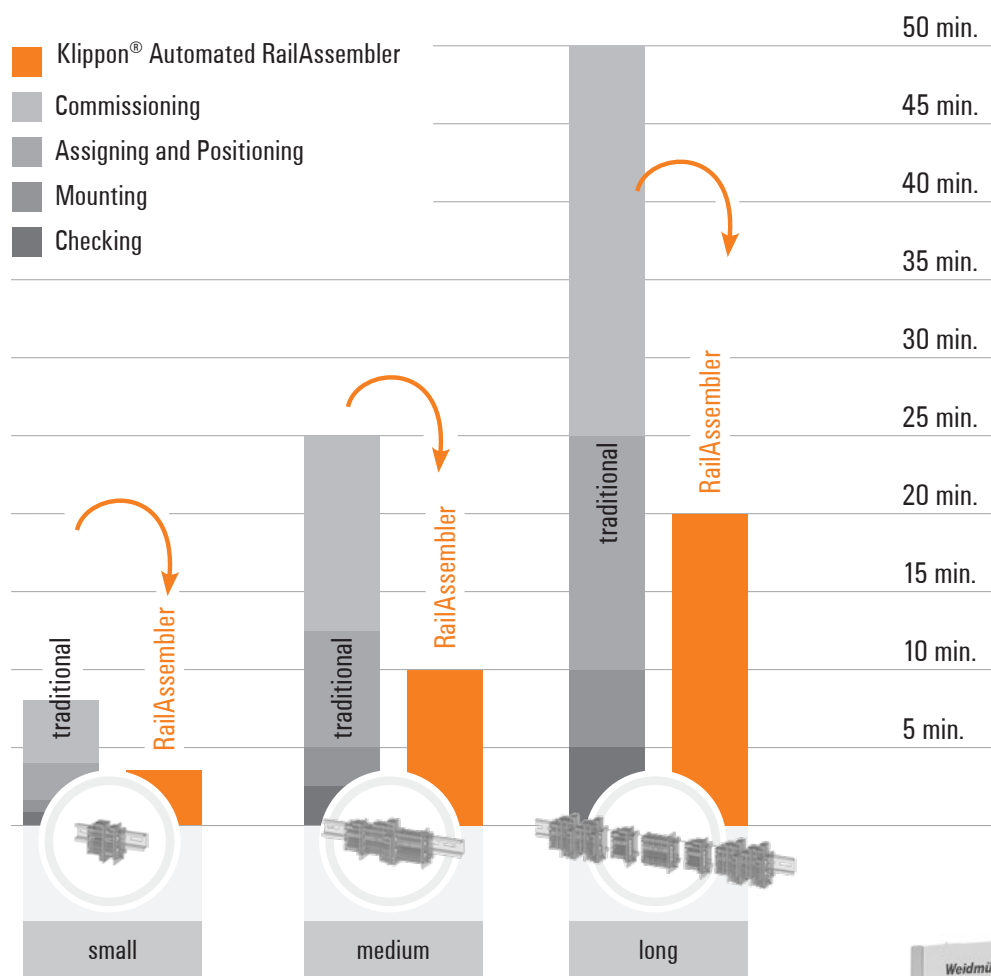

Your advantage through innovative technologies

The cost-effective system for fully automated terminal block assembly

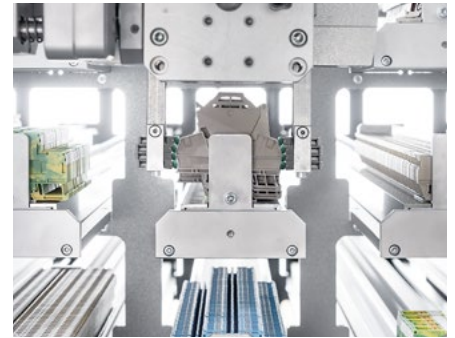

Maximum flexibility

The universal magazines can be loaded with various components due to its universal design. Hereby maximum flexibility in operation is guaranteed. The machine has a total of 48 magazine positions for components as well as 20 positions for pre cut mounting rails.

Reliable quality

A continuous use of planning data from eCAD programs is possible through the Weidmüller Configurator (WMC). Due to the omission of the manual production steps, error potentials are minimized.

Contour robust gripper

Due to the adaptive gripper even complex component geometries can be handled robustly. Thus, the application range of the machine is maximized.

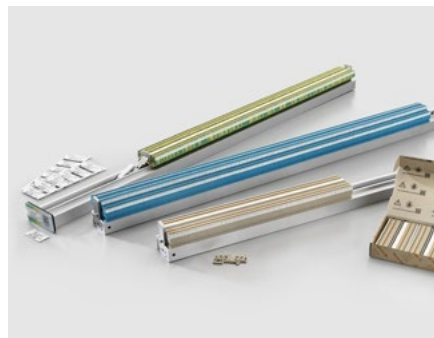

Optimized handling

Due to the generous storage capacity of the magazines filling processes are reduced to a minimum while also avoiding open quantities. Furthermore, the magazines already enable a fixed hold of individual components during the loading procedure. Consequently, the components cannot fall over on the magazine.

Matching assortment

Based on the Weidmüller standard markers a suitable portfolio of the Klippon® Connect A-Series with pre-assembled markers is available. In combination with the Klippon® Automated RailLaser for fully automatic marking, the full optimization potential can be reached.

Consistent transparency

The consistent software support during all work steps assists the operator and ensuring transparency on the order status.

Perfect for
200.000
terminal blocks
per year



Technical data

Supply voltage	400V AC / 16 A / 3.25 kW
Dimensions machine (W × H × D)	2400 x 2100 x 2100 mm
Dimensions output platform (W × H × D)	2100 x 1400 x 1250 mm
Installation area (W × D)	5700 x 5700 mm
Weight	2200 + 200 kg output platform
Interfaces	USB, Ethernet
Software	Weidmüller Configurator WMC
Mounting rail length	100 -1200 mm
Component magazine positions	48
Mounting rail magazine positions	20
Compressed air supply	6 bar / 1m³/h

Ordering data

Type	Order No.
RAILASSEMBLER	2738690000

More technical details and further labelling systems can be found at our website.



The perfect complement for our Klippon® Automated RailAssembler Klippon® Automated RailLaser



The core of the Klippon® Automated RailLaser is an image processing system that is used to measure the terminal strips before the marking process. It determines the actual position of each marker, compares it with the theoretical position from the digital model and carries out the corresponding corrections fully automatically. This ensures a perfect marking result even in case of position deviations – e.g. because of thermal expansion of the components or inaccurate clamp position due to manual assembly.

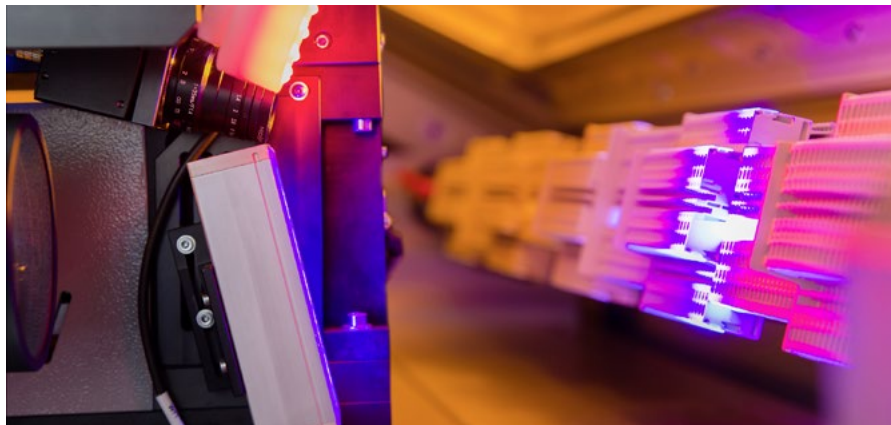

The following illustrations show the advantage of labelling using the image processing system of the Klippon® Automated RailLaser: The system ensures first-class marking results in various applications and guarantees a high-quality appearance of the terminal strip in the finished control cabinet.



Matching assortment

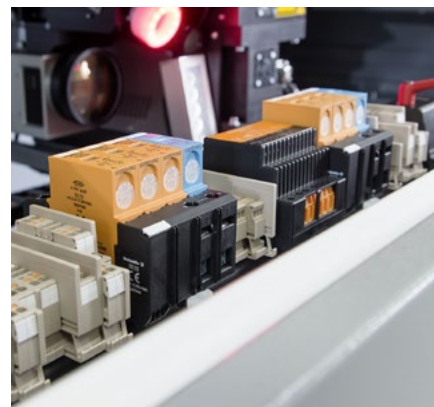

Reliable quality



Ordering data

Type	Order No.
RAILLASER	2705010000

More technical details and further labelling systems can be found in our online catalogue.



The perfect complement for our Klippon® Automated RailLaser

Klippon® Connect A-Series

In addition to the marking process, equipping the terminal blocks with markers is also very time-consuming.

That is why we already carried out this step for you. Use our Weidmüller standard markers, which are pre-equipped with Klippon® Connect A-Series terminal blocks. You benefit from the full optimisation potential of the Klippon® Automated RailLaser.

Our Klippon® Connect A-Series has been designed to be ready-to-robot. Special features such as the gripper-optimised outer contours ensure safe handling with a robot.



Markers can be easily replaced



In addition, customers can also mount the markers themselves

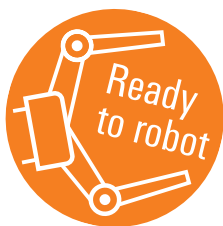

Feed-through terminal blocks

Type	Qty.	Order No.
A2C 1.5 DL	100	2674590000
A3C 1.5 DL BL	50	2674640000
A3C 1.5 DL	50	2674630000
A2C 1.5 DL BL	100	2674600000
A4C 1.5 DL	100	2674660000
A4C 1.5 DL BL	100	2674670000
A2C 2.5 DL	100	2674690000
A2C 2.5 DL BL	100	2674700000
A2C 2.5 DL OR	100	2799150000
A3C 2.5 DL	100	2674720000
A3C 2.5 DL BL	100	2674730000
A4C 2.5 DL	100	2674750000
A4C 2.5 DL BL	100	2674760000
A4C 2.5 DL OR	100	2799160000
A2C 4 DL	100	2674780000
A2C 4 DL BL	100	2674790000
A2C 4 DL OR	100	2799170000
A3C 4 DL	50	2674810000
A3C 4 DL BL	50	2674820000

Feed-through terminal blocks

Type	Qty.	Order No.
A4C 4 DL	50	2674840000
A4C 4 DL BL	50	2674850000
A4C 4 DL OR	50	2799180000
A2C 6 DL	50	2674870000
A2C 6 DL BL	50	2674880000
A3C 6 DL	50	2674900000
A3C 6 DL BL	50	2674920000
A2C 6 DL OR	50	2799190000
A4C 6 DL	50	2881500000
A4C 6 DL BL	50	2881510000
A4C 6 DL OR	50	2881520000
A4C 6 DL FE	50	2881530000
A2C 10 DL	100	2674940000
A2C 10 DL BL	25	2674950000
A3C 10 DL	25	2674970000
A3C 10 DL BL	25	2674980000
A2C 16 DL	20	2675000000
A2C 16 DL BL	20	2675010000
A3C 16 DL	20	2675030000

Feed-through terminal blocks

Type	Qty.	Order No.
A3C 16 DL BL	20	2675040000
A2C 35 DL	10	2742060000
A2C 35 DL BL	10	2755890000
A2C 35 FE DL	10	2742070000
A2C 50/70 DL	5	2742090000
A2C 50/70 DL BL	5	2755900000
A2C 50/70 FE DL	5	2742100000
A2C 95/120 DL	5	2742120000
A2C 95/120 DL BL	5	2755910000
A2C 95/120 FE DL	5	2742130000
A2T 1.5 DL	50	2675060000
A2T 1.5 DL BL	50	2675070000
A2T 1.5 FT-PE DL	50	2675080000
A2T 1.5 VL DL	50	2675090000
A2T 2.5 DL	50	2675110000
A2T 2.5 DL BL	50	2675120000
A2T 2.5 FT-PE DL	50	2675130000
A2T 2.5 VL DL	50	2675140000
A2T 2.5 VL DL BL	50	2815620000

Spring connection with PUSH IN technology (A-Series)

Terminal blocks with integrated markers

Feed-through terminal blocks

Type	Qty.	Order No.
A2T 4 DL	50	2675160000
A2T 4 DL BL	50	2675170000
A2T 4 FT-PE DL	50	2675180000
A2T 4 VL DL	50	2675190000
A3T 1.5 DL	50	2856200000
A3T 1.5 BL DL	50	2856210000
A3T 1.5 VL DL	50	2856220000
A3T 1.5 FT-PE DL	50	2856230000
A3T 2.5 DL	50	2771890000
A3T 2.5 VL DL	25	2735510000
A3T 2.5 FT-PE DL	50	2757430000
AMC 2.5 800V DL	50	2742050000
AMC 2.5 DL	50	2742040000
Availability on request		

PE terminal blocks

Type	Qty.	Order No.
A2C 1.5 PE DL	50	2674610000
A3C 1.5 PE DL	50	2674650000
A4C 1.5 PE DL	50	2674680000
A2C 2.5 PE DL	50	2674710000
A3C 2.5 PE DL	50	2674740000
A4C 2.5 PE DL	50	2674770000
A2C 4 PE DL	50	2674800000
A3C 4 PE DL	50	2674830000
A4C 4 PE DL	50	2674860000
A2C 6 PE DL	50	2674890000
A3C 6 PE DL	50	2674930000
A4C 6 PE DL	50	2881540000
A2C 10 PE DL	50	2674960000
A3C 10 PE DL	25	2674990000
A2C 16 PE DL	20	2675020000
A3C 16 PE DL	20	2675050000
A2C 35 PE DL	10	2735950000
A2C 50/70 PE DL	5	2742110000
A2C 95/120 PE DL	5	2742140000
A2T 1.5 PE DL	50	2675100000
A2T 2.5 PE DL	50	2675150000
A2T 4 PE DL	50	2675200000
A3T 1.5 PE DL	50	2856240000
Availability on request		

Test-disconnect and fuse terminal blocks

Type	Qty.	Order No.
ADT 2.5 2C DL	50	2675210000
ADT 2.5 2C DL BL	50	2675220000
ADT 2.5 4C DL	50	2675230000
ADT 4 2C DL	50	2675240000
AFS 4 2C DL BK	50	2675250000
AFS 4 2C 10-36V DL BK	50	2675260000
AFS 4 2C 100-250V DL BK	50	2675290000
AFS 4 2C 30-70V DL BK	50	2675270000
AFS 4 2C 60-150V DL BK	50	2675280000
Availability on request		

Pluggable terminal blocks

Type	Qty.	Order No.
APGTB 1.5 FT 2C/1 DL	50	2675680000
APGTB 1.5 FT 2C/1 DL BL	50	2675690000
APGTB 1.5 PE 2C/1 DL	50	2675700000
APGTB 1.5 FT 3C/1 DL	50	2675710000
APGTB 1.5 FT 3C/1 DL BL	50	2675720000
APGTB 1.5 PE 3C/1 DL	50	2675730000
APGTB 1.5 FT 4C/2 DL	50	2675740000
APGTB 1.5 FT 4C/2 DL BL	50	2675750000
APGTB 1.5 PE 4C/2 DL	50	2675760000
APGTB 2.5 FT 2C/1 DL	100	2675820000

Pluggable terminal blocks

Type	Qty.	Order No.
APGTB 2.5 FT 2C/1 DL BL	100	2675830000
APGTB 2.5 PE 2C/1 DL	50	2675840000
APGTB 2.5 FT 3C/1 DL	50	2675850000
APGTB 2.5 FT 3C/1 DL BL	50	2675860000
APGTB 2.5 PE 3C/1 DL	50	2675870000
APGTB 2.5 FT 4C/2 DL	50	2675880000
APGTB 2.5 FT 4C/2 DL BL	50	2675890000
APGTB 2.5 PE 4C/2 DL	50	2675900000
APGTB 4 FT 2C/1 DL	100	2675960000
APGTB 4 FT 2C/1 DL BL	100	2675970000
APGTB 4 PE 2C/1 DL	50	2675980000
APGTB 4 FT 3C/1 DL	50	2675990000
APGTB 4 FT 3C/1 DL BL	50	2676000000
APGTB 4 PE 3C/1 DL	50	2676010000
APGTB 4 FT 4C/2 DL	50	2676020000
APGTB 4 FT 4C/2 DL BL	50	2676030000
APGTB 4 PE 4C/2 DL	50	2676040000
APGTB 1.5 2T 4C/2 DL	50	2675770000
APGTB 1.5 2T 4C/2 DL BL	50	2675780000
APGTB 1.5 2T FT-PE 4C/2 DL	50	2675790000
APGTB 1.5 2T VL 4C/2 DL	50	2675810000
APGTB 1.5 2T PE 4C/2 DL	50	2675800000
APGTB 1.5 2T 2C/1 DL	50	2675910000
APGTB 2.5 2T 4C/2 DL BL	50	2675920000
APGTB 2.5 2T FT-PE 4C/2 DL	50	2675930000
APGTB 2.5 2T VL 4C/2 DL	50	2675950000
APGTB 2.5 2T PE 4C/2 DL	50	2675940000
APGTB 4 2T 4C/2 DL	50	2676050000
APGTB 4 2T 4C/2 DL BL	50	2676060000
APGTB 4 2T FT-PE 4C/2 DL	50	2676070000
APGTB 4 2T VL 4C/2 DL	50	2676090000
APGTB 4 2T PE 4C/2 DL	50	2676080000
Availability on request		

Signal wiring terminal blocks

Type	Qty.	Order No.
AIO21 1.5 SI DL	100	2675580000
AIO21 1.5 SI DL OR	100	2675630000
AIO21 1.5 SO DL	100	2675590000
AIO21 1.5 SO DL OR	100	2675640000
AIO21 1.5 SO-PE DL	100	2675600000
AIO21 1.5 SO-PE DL OR	100	2675650000
AIO22 1.5 SI-PE DL	100	2675610000
AIO22 1.5 SI-PE DL OR	100	2675660000
AIO23 1.5 2SI DL	100	2675620000
AIO23 1.5 2SI DL OR	50	2675670000
Availability on request		

Control voltage distribution

Type	Qty.	Order No.
AAP11 6 LO DL RD	20	2675300000
AAP11 6 LO DL BL	20	2675320000
AAP11 6 LO DL OR	20	2675310000
AAP11 6 LO DL BL/OR	20	2675330000
AAP11 6/1.5 LO-LI DL RD	20	2675390000
AAP11 6/1.5 LO-LI DL BL	20	2675380000
AAP11 6/1.5 LO-LI DL OR	20	2675400000
AAP11 6/1.5 LO-LI DL BL/OR	20	2675410000
AAP11 1.5 LI DL RD	50	2675340000
AAP11 1.5 LI DL BL	50	2675360000
AAP11 1.5 LI DL OR	50	2675350000
AAP11 1.5 LI DL BL/OR	50	2675370000
AAP12 10 LO DL RD	20	2675420000
AAP12 10 LO DL BL	20	2675440000
AAP12 10 LO DL OR	20	2675430000
AAP12 10 LO DL BL/OR	20	2675450000
AAP12 10/2.5 LO-LI DL RD	20	2675500000
AAP12 10/2.5 LO-LI DL BL	20	2675530000

Control voltage distribution

Type	Qty.	Order No.
AAP12 10/2.5 LO-LI DL OR	20	2675510000
AAP12 10/2.5 LO-LI DL BL/OR	20	2675520000
AAP12 10/4X2.5 PE-LI DL	20	2742080000
AAP12 2.5 LI DL RD	50	2675460000
AAP12 2.5 LI DL BL	50	2675490000
AAP12 2.5 LI DL OR	50	2675470000
AAP12 2.5 LI DL BL/OR	50	2675480000
AAP13 6 LO-LO DL	20	2675540000
AAP13 1.5 LI-LI DL	50	2675550000
AAP14 10 LO-LO DL	20	2675560000
AAP14 2.5 LI-LI DL	50	2675570000
Availability on request		

Terminal blocks with SNAP IN technology

Type	Qty.	Order No.
AS2C 2.5 DL	100	2862960000
AS3C 2.5 DL	100	2862970000
AS4C 2.5 DL	100	2862980000
AS2C 2.5 DL BL	100	2862990000
AS3C 2.5 DL BL	100	2863000000
AS4C 2.5 DL BL	100	2863010000
AS2C 2.5 PE DL	100	2863020000
AS3C 2.5 PE DL	100	2863030000
AS4C 2.5 PE DL	100	2863040000
S2C 4 DL	100	2874910000
S3C 4 DL	50	2874920000
S4C 4 DL	50	2874930000
S2C 4 DL BL	50	2874940000
S3C 4 DL BL	50	2874950000
S4C 4 DL BL	50	2874960000
S2C 4 PE DL	50	2874970000
S3C 4 PE DL	50	2874980000
S4C 4 PE DL	50	2874990000
S2T 2.5 DL	50	2902470000
S2T 2.5 DL BL	50	2902480000
S2T 2.5 FT-PE DL	50	2902490000
S2T 2.5 VL DL	50	2902500000
S2T 2.5 VL DL BL	50	2902510000
S2T 2.5 PE DL	50	2902520000
Availability on request		

Hybride terminal blocks

Type	Qty.	Order No.
AWPD 35 4X10 DL	20	2798140000
AWPD 35 4X6/6X2.5 DL	20	2798150000
Availability on request		

Terminal blocks for instrument transformer wiring

Type	Qty.	Order No.
ATTB 6 DL	50	2792420000
ATTB 6 PE DL	50	2792430000
WTTB 6 DL	50	2792440000
WTTB 6 PE DL	50	2792450000
HTTB 6 DL	50	2792460000
HTTB 6 PE DL	50	2792470000
Availability on request		

End brackets

Type	Qty.	Order No.
AEB 35 SCL/1 VO DL	50	2570240000
AEB 35 SCL/1 VO GY DL	50	2570260000
AEB 35 SCL/1 VO BK DL	50	2570250000
AEB 35 SCL/1 VO TGY DL	20	2817770000
Availability on request		



A2C 2.5

2.5 mm²

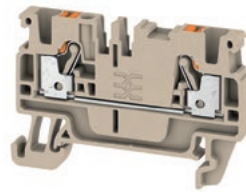

5.1 x 55 x 36.5
24 / 4
0.14...4



A2C 2.5 DL

2.5 mm²

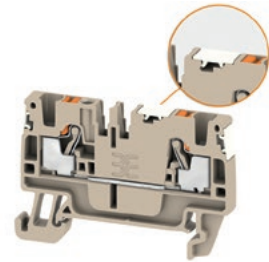

5.1 x 55 x 36.5
24 / 4
0.14...4

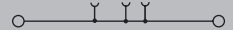

Width/Height/Depth	mm
max. current / max. cond. cross-section	A/mm ²
Max. clamping range	mm ²

Technical data

Rated data	
Rated voltage of feed-through terminal	V
Rated current	A
for wire cross-section	mm ²
Rated impulse withstand voltage / Pollution severity	
Gauge to IEC 60947-1 / UL 94 flammability rating	
Number of operating cycles	
Approvals	
Clamped conductors (H05V/H07V)	
Solid / Stranded	mm ²
Flexible / Flexible with ferrule	mm ²
Stripping length / Blade size	mm/-

Note

Ordering data

Version	
	dark beige
	Blue

Note

Accessories

Plug-in cross-connection	
	2-pole
	10-pole
End plate	
	dark beige
	Blue
End bracket	
	dark beige, screwable
	dark beige, direct mounting
Test adapter	
	1-pole
	stackable
	3-pole
	5-pole
Test plug	
	Standard
Screwdriver	
	Standard
Marking tags	

For detailed information on other accessories and application in the online catalogue

IEC 60947-7-1

IEC	UL	CSA	EN 60079-7
800	600	600	
24	20	20	
2.5	AWG 28...12	AWG 28...12	
8 kV / 3			
A3 / V-0			



Rated connection	
0.5...2.5 / 0.5...4	
0.5...4 / 0.5...2.5	
10 / 0.6 x 3.5 mm	

Type	Qty.	Order No.
A2C 2.5	100	1521850000
A2C 2.5 BL	100	1521880000

Type	Qty.	Order No.
ZQV 2.5N/2	24 A 60	1527540000
ZQV 2.5N/10	24 A 20	1527690000
AEP 2C 2.5	50	1514400000
AEP 2C 2.5 BL	50	1514420000
AEB 35 SC/1	50	1991920000
AEB 35 SCL/1 V0	20	2661280000
ATPG 1.5-10 L	0.2 A 50	1991890000
ATPG 2.5 MHR	0.2 A 50	1991960000
ATPG 2.5/3	0.2 A 25	2041190000
ATPG 2.5/5	0.2 A 25	2041180000
PS 2.0 MC	20	0310000000
SDIL 0,6X3,5X100	1	2749140000
DEK 5/5 PLUS MC NE WS	1000	1854490000
DEK 5/5 MM WS	800	2007110000
WS 8/5 MM WS	800	2007150000
WS 10/5 M PLUS MC NE WS	600	2003770000

IEC 60947-7-1

IEC	UL	CSA	EN 60079-7
800			
24			
2.5			
8 kV / 3			
A3 / V-0			



Rated connection	
0.5...2.5 / 0.5...4	
0.5...4 / 0.5...2.5	
10 / 0.6 x 3.5 mm	

Type	Qty.	Order No.
A2C 2.5 DL	100	2674690000

Type	Qty.	Order No.
ZQV 2.5N/2	24 A 60	1527540000
ZQV 2.5N/10	24 A 20	1527690000
AEP 2C 2.5	50	1514400000
AEP 2C 2.5 BL	50	1514420000
AEB 35 SC/1	50	1991920000
AEB 35 SCL/1 V0	20	2661280000
ATPG 1.5-10 L	0.2 A 50	1991890000
ATPG 2.5 MHR	0.2 A 50	1991960000
ATPG 2.5/3	0.2 A 25	2041190000
ATPG 2.5/5	0.2 A 25	2041180000
PS 2.0 MC	20	0310000000
SDIL 0,6X3,5X100	1	2749140000





Integrated partition plate

APP1



Dimensions	
Width / Height / Depth	mm
Continuous operating temp., min.	-60 °C
Continuous operating temp., max.	130 °C
Material	Wemid
UL 94 flammability rating	V-0

Ordering data	
	dark beige
	matching terminals

Type	VPE	Order No.
APP 1	50	2488970000
A2C 1.5		1552790000
A2C 1.5 PE		1552680000
APGTB 1.5 FT 2C/1		2482160000
APGTB 1.5 PE 2C/1		2482220000
A2C 2.5		1521850000
A2C 2.5 PE		1521680000
APGTB 2.5 FT 2C/1		1513970000
APGTB 2.5 PE 2C/1		1513870000

APP2



Type	Qty.	Order No.
APP 2	50	2489090000
A3C 1.5		1552740000
A3C 1.5 PE		1552670000
A4C 1.5		1552690000
A4C 1.5 PE		1552660000
APGTB 1.5 FT 3C/1		2482180000
APGTB 1.5 PE 3C/1		2482230000
ADT 2.5 2C		1989800000
A2C 2.5 /DT/FS		1989900000
A2C 2.5 PE /DT/FS		1989890000
A3C 2.5		1521740000
A3C 2.5 PE		1521670000
A4C 2.5		1521690000
A4C 2.5 PE		1521540000
APGTB 2.5 FT 3C/1		1514000000
APGTB 2.5 PE 3C/1		1513890000
AFS 2.5 CF 2C BK		2466530000
AFS 2.5 CF 2C 12V BK		2466610000
AFS 2.5 CF 2C 24V BK		2466600000
A2C 4		2051180000
A2C 4 PE		2051360000
A3C 4		2051240000
A3C 4 PE		2051410000
A4C 4		2051500000
A4C 4 PE		2051560000
ADT 4 2C		2429850000
AFS 4 2C BK		2429860000
A2C 6		1992110000
A2C 6 PE		1991810000

APP3



Type	Qty.	Order No.
APP 3	50	2489100000
APGTB 1.5 FT 4C/2		2482200000
APGTB 1.5 PE 4C/2		2482240000
APGTB 2.5 FT 4C/2		1514030000
APGTB 2.5 PE 4C/2		1513920000
ADT 2.5 3C		1989830000
ADT 2.5 4C		1989860000
A3C 6		1991820000
A3C 6 PE		1991850000
AAP11 ...		
AAP13 ...		
AI021 1.5 SI		1992260000
AI021 1.5 SO		1992240000
AI021 1.5 SO-PE		1992250000
AI022 1.5 SI-PE		1992230000

Note

Integrated partition plate

APP4



Dimensions	
Width / Height / Depth	mm
Continuous operating temp., min.	-60 °C
Continuous operating temp., max.	130 °C
Material	Wemid
UL 94 flammability rating	V-0

Ordering data	
	dark beige
	matching terminals

Type	Qty.	Order No.
APP 4	50	2489110000
APGTB 1.5 2T 4C/2		2485840000
APGTB 1.5 2T PE 4C/2		2485870000
A2T 1.5		2469370000
A2T 1.5 PE		2469410000
A2T 2.5		1547610000
A2T 2.5 PE		1547680000
APGTB 2.5 2T 4C/2		1548060000
APGTB 2.5 2T PE 4C/2		1548160000

Note



Pluggable Cross-Connection ZQV



Weidmüller offers plug-in and screwed cross-connection systems for screw-connection terminal blocks. The plug-in cross-connections feature easy handling and quick installation. This saves a great deal of time during installation in comparison with screwed solutions. This also ensures that all poles always contact reliably.

Fitting and changing crossconnections

The fitting and changing of cross-connections is a trouble-free and fast operation:

- Insert the cross-connection into the crossconnection channel in the terminal...

... and press it fully home.
(The cross-connection may not project from the channel.)

- Remove a cross-connection by simply prising it out with a screwdriver.

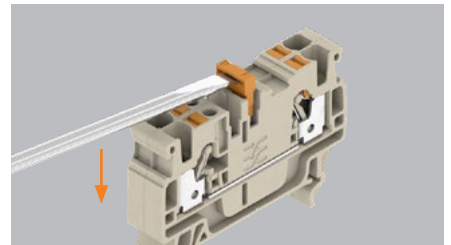
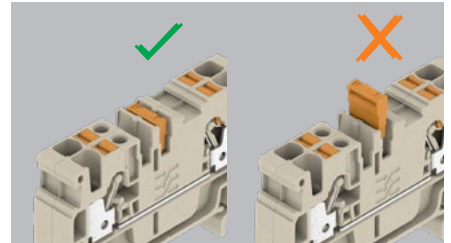
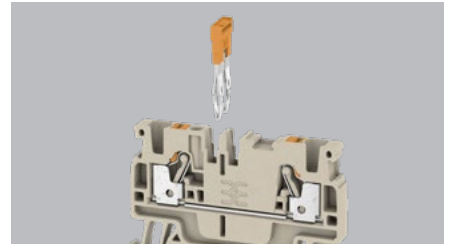

Shortening cross-connections

Cross-connections can be shortened in length using a suitable cutting tool, e.g. KT ZQV (order no. 9002170000). However, three contact elements must always be retained.

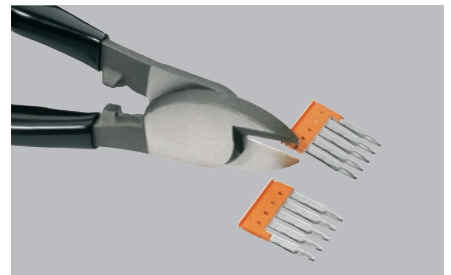

Breaking out contact elements

If one or more (max. 60 % for reasons of stability and temperature rise) of the contact elements are broken out of the cross-connections, terminals may be bypassed to suit the application.

Caution:
Contact elements must not be deformed!

Note: By using manually cut ZQV and cross-connections with blank cut edges (> 10 poles) the voltage reduces to 25 V.

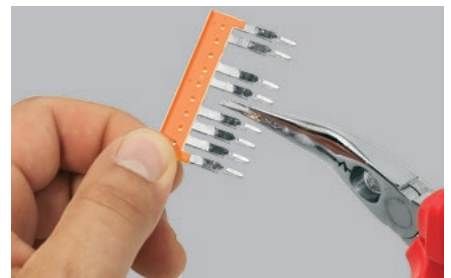

ALO 6 and ALO 16 supply terminals

The ALO 6 and ALO 16 supply terminals can be fed by wires of cross-section 6 or 16 mm². Over standard cross-connections the potential is distributed over any number of terminals blocks of smaller cross-section. Some variants for potential distribution during feed-in are indicated in the table below, including the cross-connection which can be used and the maximum current allowed.

Integrated endplate



Output options and cross-connectors to use

Supply terminal	Output terminal	Cross-connection	Feed-in left	Feed-in right
ALO 6	A2C 1.5	ZQV 1.5N	•	•
	A3C 1.5	ZQV 1.5N	•	•
	A4C 1.5	ZQV 1.5N	•	•
	A2C 2.5	ZQV 2.5N	•	•
	A3C 2.5	ZQV 2.5N	•	•
	A4C 2.5	ZQV 2.5N	•	•

Maximum current flow I_{max} only with ALO 6

Output terminal	Cross-connection	Wire cross-section	Feed-in left or right	Feed-in centred
A2C 1.5	ZQV 1.5N	6 mm ²	41 A	41 A
A3C 1.5	ZQV 1.5N	6 mm ²	41 A	41 A
A4C 1.5	ZQV 1.5N	6 mm ²	41 A	41 A
A2C 2.5	ZQV 2.5N	6 mm ²	41 A	41 A
A3C 2.5	ZQV 2.5N	6 mm ²	41 A	41 A
A4C 2.5	ZQV 2.5N	6 mm ²	41 A	41 A

Output options and cross-connectors to use

Supply terminal	Output terminal	Cross-connection	Feed-in left	Feed-in right
ALO 16	A2C 1.5	ZQV 1.5N	•	•
	A3C 1.5	ZQV 1.5N	•	•
	A4C 1.5	ZQV 1.5N	•	•
	A2C 2.5	ZQV 2.5N	•	•
	A3C 2.5	ZQV 2.5N	•	•
	A4C 2.5	ZQV 2.5N	•	•
	A2C 4	ZQV 4N	•	•
	A3C 4	ZQV 4N	•	•
	A4C 4	ZQV 4N	•	•
	A2C 6	ZQV 6N	•	•
	A3C 6	ZQV 6N	•	•

Maximum current flow I_{max} at ALO 16 with cross-section 16 mm²

Output terminal	Cross-connection	Wire cross-section	Feed-in left or right	Feed-in centred
A2C 1.5	ZQV 1.5N	16 mm ²	48 A	72 A
A3C 1.5	ZQV 1.5N	16 mm ²	48 A	72 A
A4C 1.5	ZQV 1.5N	16 mm ²	48 A	72 A
A2C 2.5	ZQV 2.5N	16 mm ²	68 A	76 A
A3C 2.5	ZQV 2.5N	16 mm ²	68 A	76 A
A4C 2.5	ZQV 2.5N	16 mm ²	68 A	76 A
A2C 4	ZQV 4N	16 mm ²	76 A	76 A
A3C 4	ZQV 4N	16 mm ²	76 A	76 A
A4C 4	ZQV 4N	16 mm ²	76 A	76 A
A2C 6	ZQV 6N	16 mm ²	76 A	76 A
A3C 6	ZQV 6N	16 mm ²	76 A	76 A

Maximum current flow I_{max} at ALO 16 with cross-section 10 mm²

Output terminal	Cross-connection	Wire cross-section	Feed-in left or right	Feed-in centred
A2C 1.5	ZQV 1.5N	10 mm ²	48 A	57 A
A3C 1.5	ZQV 1.5N	10 mm ²	48 A	57 A
A4C 1.5	ZQV 1.5N	10 mm ²	48 A	57 A
A2C 2.5	ZQV 2.5N	10 mm ²	57 A	57 A
A3C 2.5	ZQV 2.5N	10 mm ²	57 A	57 A
A4C 2.5	ZQV 2.5N	10 mm ²	57 A	57 A
A2C 4	ZQV 4N	10 mm ²	57 A	57 A
A3C 4	ZQV 4N	10 mm ²	57 A	57 A
A4C 4	ZQV 4N	10 mm ²	57 A	57 A
A2C 6	ZQV 6N	10 mm ²	57 A	57 A
A3C 6	ZQV 6N	10 mm ²	57 A	57 A

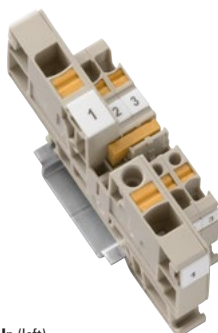

I_{max} = Σ I_n (left)



I_{max} = Σ I_n (left) + Σ I_n (right)



I_{max} = Σ I_n (right)

Supply with standard terminals

According to IEC 60204-1 and IEC 60 439-1, when reducing the conductors within distribution boards and controllers, protective devices for cables and conductors can be installed up to a maximum of 3 meters away from the supply side and need not be positioned at the beginning of the supply side. The conductor before the output fuse must be routed to make it "short-circuit proof".

Supply on the left

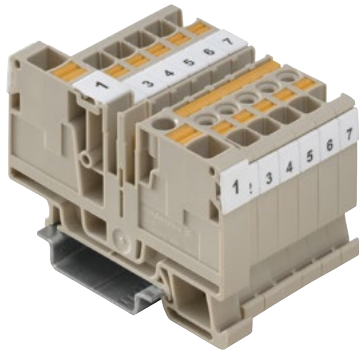

Supply on the right

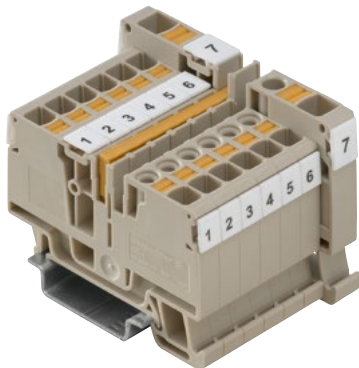

Supply options and corresponding cross-connections

Supply terminals		left											
		2.5 mm ²					4 mm ²					6 mm ²	
		A2C	A3C	A4C	ADT 2C	AFS 2C CF	A2C	A3C	A4C	ADT 2C	AFS 2C	A2C	A3C
Output terminals right													
1.5 mm ²	A2C	ZOV 1.5N	•										
	A3C	ZOV 1.5N	•	•									
	A4C	ZOV 1.5N	•	•	•	•	•						
2.5 mm ²	A2C	ZOV 2.5N					•	•					
	A3C	ZOV 2.5N					•	•	•				
	A4C	ZOV 2.5N					•	•	•	•			
	ADT 2C	ZOV 2.5N					•	•	•	•			
AFS 2C CF	ZOV 2.5N					•	•	•	•	•			
4 mm ²	A2C	ZOV 4N										•	•
	A3C	ZOV 4N										•	•
	A4C	ZOV 4N										•	•
	ADT 2C	ZOV 4N										•	•
	AFS 2C	ZOV 4N										•	•

Supply terminals		right											
		2.5 mm ²					4 mm ²					6 mm ²	
		A2C	A3C	A4C	ADT 2C	AFS 2C CF	A2C	A3C	A4C	ADT 2C	AFS 2C	A2C	A3C
Output terminals left													
1.5 mm ²	A2C	ZOV 1.5N	•	•	•	•	•						
	A3C	ZOV 1.5N		•	•	•	•						
	A4C	ZOV 1.5N			•	•	•						
2.5 mm ²	A2C	ZOV 2.5N					•	•					
	A3C	ZOV 2.5N					•	•	•				
	A4C	ZOV 2.5N						•	•	•			
	ADT 2C	ZOV 2.5N						•	•	•			
AFS 2C CF	ZOV 2.5N							•	•	•			
4 mm ²	A2C	ZOV 4N										•	•
	A3C	ZOV 4N										•	•
	A4C	ZOV 4N										•	•
	ADT 2C	ZOV 4N										•	•
	AFS 2C	ZOV 4N										•	•

Possible combinations

In one cross-connection channel

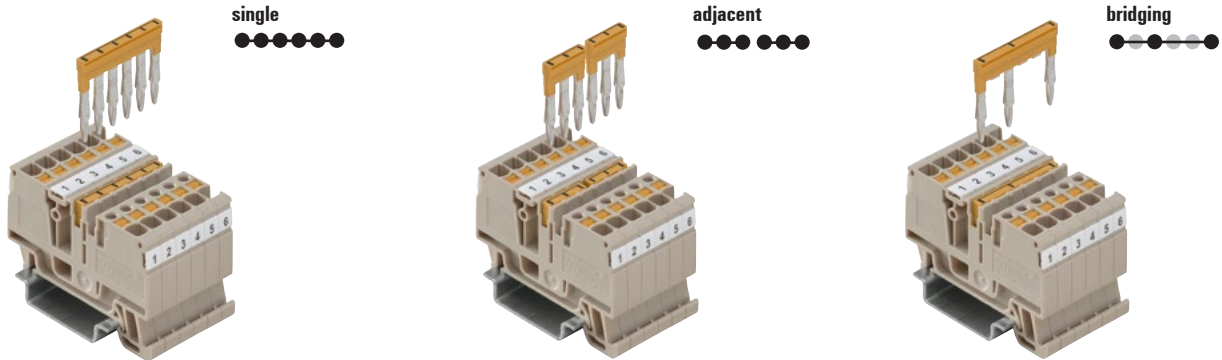

In two cross-connection channels

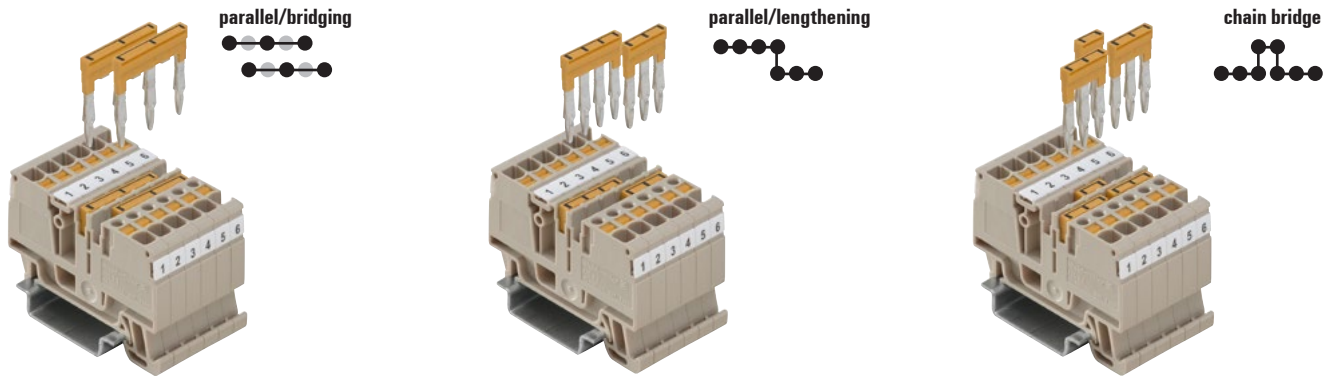

Possible cross-connections of terminals of the same type with corresponding cross-connections

Terminal type	Cross-section	Cross-connection	single	adjacent	bridging	chain bridge	parallel bridging	parallel lengthening
Standard terminals	mm ²							
A ... C	1.5	ZQV 1.5N/...	•	•	•	•	•	•
A2T	1.5	ZQV 1.5N/...	•	•	•	•	•	
A2T PE	1.5	ZQV 1.5N/...	•	•	•	•	•	
A3T	1.5	ZQV 1.5N/...	•	•	•	•	•	
A3T PE	1.5	ZQV 1.5N/...	•	•	•	•	•	
APGTB	1.5	ZQV 1.5N/...	•	•	•	•	•	
APGTB 2T	1.5	ZQV 1.5N/...	•	•	•	•	•	
APGTB 2T PE	1.5	ZQV 1.5N/...	•	•	•	•	•	
A ... C	2.5	ZQV 2.5N/...	•	•	•	•	•	
A2T	2.5	ZQV 2.5N/...	•	•	•	•	•	
A2T PE	2.5	ZQV 2.5N/...	•	•	•	•	•	
A3T	2.5	ZQV 2.5N/...	•	•	•	•	•	
A3T PE	2.5	ZQV 2.5N/...	•	•	•	•	•	
ADT	2.5	ZQV 2.5N/...	•	•	•	•	•	
AFS	2.5	ZQV 2.5N/...	•	•	•	•	•	
APGTB	2.5	ZQV 2.5N/...	•	•	•	•	•	
APGTB 2T	2.5	ZQV 2.5N/...	•	•	•	•	•	
APGTB 2T PE	2.5	ZQV 2.5N/...	•	•	•	•	•	
A ... C	4	ZQV 4N/...	•	•	•	•	•	
A2T	4	ZQV 4N/...	•	•	•	•	•	
A2T PE	4	ZQV 4N/...	•	•	•	•	•	
ADT	4	ZQV 4N/...	•	•	•	•	•	
AFS	4	ZQV 4N/...	•	•	•	•	•	
APGTB	4	ZQV 4N/...	•	•	•	•	•	
APGTB 2T	4	ZQV 4N/...	•	•	•	•	•	
APGTB 2T PE	4	ZQV 4N/...	•	•	•	•	•	
A ... C	6	ZQV 6N/...	•	•	•	•	•	
A ... C	10	ZQV 10N/...	•	•	•	•	•	
A ... C	16	ZQV 16N/...	•	•	•	•	•	



Cross-connections according to dimensions



ZQV 1.5N



Technical data	
Rated current	A
Ordering data	
2-pole	
3-pole	
4-pole	
5-pole	
6-pole	
7-pole	
8-pole	
9-pole	
10-pole	
20-pole	
41-poles	
50-pole	
Note	

17.5			
Type	Qty.	Order No.	
ZQV 1.5N/2	60	1985410000	
ZQV 1.5N/3	60	1985480000	
ZQV 1.5N/4	60	1985490000	
ZQV 1.5N/5	20	1985500000	
ZQV 1.5N/6	20	1985510000	
ZQV 1.5N/7	20	1985520000	
ZQV 1.5N/8	20	1985540000	
ZQV 1.5N/9	20	1985560000	
ZQV 1.5N/10	20	1985580000	
ZQV 1.5N/20	20	1985600000	
ZQV 1.5N/50	5	1985620000	
Note			

ZQV 2.5N



24			
Type	Qty.	Order No.	
ZQV 2.5N/2	60	1527540000	
ZQV 2.5N/3	60	1527570000	
ZQV 2.5N/4	60	1527590000	
ZQV 2.5N/5	20	1527620000	
ZQV 2.5N/6	20	1527630000	
ZQV 2.5N/7	20	1527640000	
ZQV 2.5N/8	20	1527670000	
ZQV 2.5N/9	20	1527680000	
ZQV 2.5N/10	20	1527690000	
ZQV 2.5N/20	20	1527720000	
ZQV 2.5N/50	5	1527730000	
Note			

ZQV 4N



32			
Type	Qty.	Order No.	
ZQV 4N/2	60	1527930000	
ZQV 4N/3	60	1527940000	
ZQV 4N/4	60	1527970000	
ZQV 4N/5	60	1527980000	
ZQV 4N/6	20	1527990000	
ZQV 4N/7	20	1528020000	
ZQV 4N/8	20	1528030000	
ZQV 4N/9	20	1528070000	
ZQV 4N/10	20	1528090000	
ZQV 4N/20	20	2883800000	
ZQV 4N/41		2883810000	
ZQV 4N/50	5	1528130000	
Note			



Technical data	
Rated current	A
Ordering data	
2-pole	
3-pole	
4-pole	
5-pole	
6-pole	
7-pole	
8-pole	
9-pole	
10-pole	
20-pole	
41-poles	
50-pole	
Note	

17.5			
Type	Qty.	Order No.	
ZQV 1.5N/2 BL	60	1985530000	
ZQV 1.5N/3 BL	60	1985550000	
ZQV 1.5N/4 BL	60	1985570000	
ZQV 1.5N/5 BL	20	1985590000	
ZQV 1.5N/6 BL	20	1985610000	
ZQV 1.5N/7 BL	20	1985630000	
ZQV 1.5N/8 BL	20	1985640000	
ZQV 1.5N/9 BL	20	1985660000	
ZQV 1.5N/10 BL	20	1985680000	
ZQV 1.5N/20 BL	20	1985700000	
ZQV 1.5N/50 BL	5	1985720000	
Note			



24			
Type	Qty.	Order No.	
ZQV 2.5N/2 BL	60	1527740000	
ZQV 2.5N/3 BL	60	1527770000	
ZQV 2.5N/4 BL	60	1527780000	
ZQV 2.5N/5 BL	20	1527790000	
ZQV 2.5N/6 BL	20	1527820000	
ZQV 2.5N/7 BL	20	1527830000	
ZQV 2.5N/8 BL	20	1527840000	
ZQV 2.5N/9 BL	20	1527870000	
ZQV 2.5N/10 BL	20	1527880000	
ZQV 2.5N/20 BL	20	1527890000	
ZQV 2.5N/50 BL	5	1527920000	
Note			



32			
Type	Qty.	Order No.	
ZQV 4N/2 BL	60	1528040000	
ZQV 4N/3 BL	60	1528080000	
ZQV 4N/4 BL	60	1528120000	
ZQV 4N/5 BL	60	1528140000	
ZQV 4N/6 BL	20	1528170000	
ZQV 4N/7 BL	20	1528180000	
ZQV 4N/8 BL	20	1528190000	
ZQV 4N/9 BL	20	1528220000	
ZQV 4N/10 BL	20	1528230000	
ZQV 4N/20 BL	20	2810850000	
ZQV 4N/41 BL		2883820000	
ZQV 4N/50 BL	5	1528240000	
Note			



Technical data	
Rated current	A
Ordering data	
2-pole	
3-pole	
4-pole	
5-pole	
6-pole	
7-pole	
8-pole	
9-pole	
10-pole	
20-pole	
41-poles	
50-pole	
Note	

17.5			
Type	Qty.	Order No.	
ZQV 1.5N/2 RD	60	1985650000	
ZQV 1.5N/3 RD	60	1985670000	
ZQV 1.5N/4 RD	60	1985690000	
ZQV 1.5N/5 RD	20	1985710000	
ZQV 1.5N/6 RD	20	1985730000	
ZQV 1.5N/7 RD	20	1985750000	
ZQV 1.5N/8 RD	20	1985770000	
ZQV 1.5N/9 RD	20	1985790000	
ZQV 1.5N/10 RD	20	1985800000	
ZQV 1.5N/20 RD	20	1985810000	
ZQV 1.5N/50 RD	5	1985820000	
Note			



24			
Type	Qty.	Order No.	
ZQV 2.5N/2 RD	60	2108470000	
ZQV 2.5N/3 RD	60	2108690000	
ZQV 2.5N/4 RD	60	2108700000	
ZQV 2.5N/5 RD	20	2108710000	
ZQV 2.5N/6 RD	20	2108720000	
ZQV 2.5N/7 RD	20	2108810000	
ZQV 2.5N/8 RD	20	2108870000	
ZQV 2.5N/9 RD	20	2108900000	
ZQV 2.5N/10 RD	20	2108910000	
ZQV 2.5N/20 RD	20	2108920000	
ZQV 2.5N/50 RD	5	2109000000	
Note			



32			
Type	Qty.	Order No.	
ZQV 4N/2 RD	60	2460450000	
ZQV 4N/3 RD	60	2460810000	
ZQV 4N/4 RD	60	2460800000	
ZQV 4N/5 RD	60	2460790000	
ZQV 4N/6 RD	20	2460780000	
ZQV 4N/7 RD	20	2460770000	
ZQV 4N/8 RD	20	2460760000	
ZQV 4N/9 RD	20	2460750000	
ZQV 4N/10 RD	20	2460740000	
ZQV 4N/20 RD	20	2810860000	
ZQV 4N/41 RD		2883840000	
ZQV 4N/50 RD	5	2460730000	
Note			

ZQV 6N



41		
Type	Qty.	Order No.
ZQV 6N/2	60	1985740000
ZQV 6N/3	60	1985760000
ZQV 6N/4	60	1985780000
ZQV 6N/6	20	2733950000
ZQV 6N/7	20	2733960000
ZQV 6N/10	20	2733970000
ZQV 6N/20	20	2810820000

ZQV 10N/2



57		
Type	Qty.	Order No.
ZQV 10N/2	25	2497250000

ZQV 16N/2



76		
Type	Qty.	Order No.
ZQV 16N/2	25	2497290000

ZQV 35N/2



125		
Type	Qty.	Order No.
ZQV 35N/2	10	2634950000

Reducing bridge		
Type	Qty.	Order No.
ZQV 35N - 16	10	2562660000
ZQV 35N - 10	10	2562670000



41		
Type	Qty.	Order No.
ZQV 6N/2 BL	60	1985830000
ZQV 6N/3 BL	60	1985840000
ZQV 6N/4 BL	60	1985850000
ZQV 6N/6 BL	20	2786890000
ZQV 6N/7 BL	20	2786900000
ZQV 6N/10 BL	20	2786910000



Spring connection with PUSH IN technology (A-Series)
Accessories

Cross-connections according to
dimensions

ZQV 50/70N



ZQV 95/120N



ZQV 150/185N



Technical data	
Rated current	A
Ordering data	
2-pole	
3-pole	
Note	

150		
Type	Qty.	Order No.
ZQV 50/70N/2	10	2663400000

192		
Type	Qty.	Order No.
ZQV 95/120N/2	10	2694250000
ZQV 95/120N/3	10	2694260000

232		
Type	Qty.	Order No.
ZQV 150/185N/2	5	2728840000
ZQV 150/185N/3	5	2728850000

Universal range

A



Cross-connections according to dimensions

ZQV 2.5N



ZQV 4N



Technical data	
Rated current	A
Ordering data	
2-pole	
3-pole	
4-pole	
5-pole	
6-pole	
7-pole	
8-pole	
9-pole	
10-pole	
20-pole	
41-poles	
50-pole	
Note	

24			
Type	Qty.	Order No.	
ZQV 2.5N/2 WT	60	2831560000	
ZQV 2.5N/3 WT	60	2831570000	
ZQV 2.5N/4 WT	60	2831580000	
ZQV 2.5N/5 WT	20	2831590000	
ZQV 2.5N/6 WT	20	2831600000	
ZQV 2.5N/7 WT	20	2831610000	
ZQV 2.5N/8 WT	20	2831620000	
ZQV 2.5N/9 WT	20	2831630000	
ZQV 2.5N/10 WT	20	2831640000	
ZQV 2.5N/20 WT	20	2831650000	
ZQV 2.5N/50 WT	5	2831660000	

32			
Type	Qty.	Order No.	
ZQV 4N/2 WT	60	2831800000	
ZQV 4N/3 WT	60	2831810000	
ZQV 4N/4 WT	60	2831820000	
ZQV 4N/5 WT	60	2831830000	
ZQV 4N/6 WT	20	2831840000	
ZQV 4N/7 WT	20	2831850000	
ZQV 4N/8 WT	20	2831860000	
ZQV 4N/9 WT	20	2831870000	
ZQV 4N/10 WT	20	2831790000	



Technical data	
Rated current	A
Ordering data	
2-pole	
3-pole	
4-pole	
5-pole	
6-pole	
7-pole	
8-pole	
9-pole	
10-pole	
20-pole	
41-poles	
50-pole	
Note	

24			
Type	Qty.	Order No.	
ZQV 2.5N/2 BK	60	2831670000	
ZQV 2.5N/3 BK	60	2831680000	
ZQV 2.5N/4 BK	60	2831690000	
ZQV 2.5N/5 BK	20	2831700000	
ZQV 2.5N/6 BK	20	2831710000	
ZQV 2.5N/7 BK	20	2831720000	
ZQV 2.5N/8 BK	20	2831730000	
ZQV 2.5N/9 BK	20	2831740000	
ZQV 2.5N/10 BK	20	2831750000	
ZQV 2.5N/20 BK	20	2831760000	
ZQV 2.5N/50 BK	5	2831770000	

32			
Type	Qty.	Order No.	
ZQV 4N/2 BK	60	2810840000	
ZQV 4N/3 BK	60	2810880000	
ZQV 4N/4 BK	60	2810890000	
ZQV 4N/5 BK	60	2810900000	
ZQV 4N/6 BK	20	2810910000	
ZQV 4N/7 BK	20	2810920000	
ZQV 4N/8 BK	20	2810930000	
ZQV 4N/9 BK	20	2831780000	
ZQV 4N/10 BK	20	2810830000	
ZQV 4N/20 BK	20	2810870000	
ZQV 4N/41 BK	10	2831890000	



Test adapters for self-assembly:

The test adapters offer a flexible solution for every task - they can be connected by threading them together in accordance with the application to be fulfilled.

Note:

The start plate can only be combined with one size of expansion plate.

Structure of the test adapter system

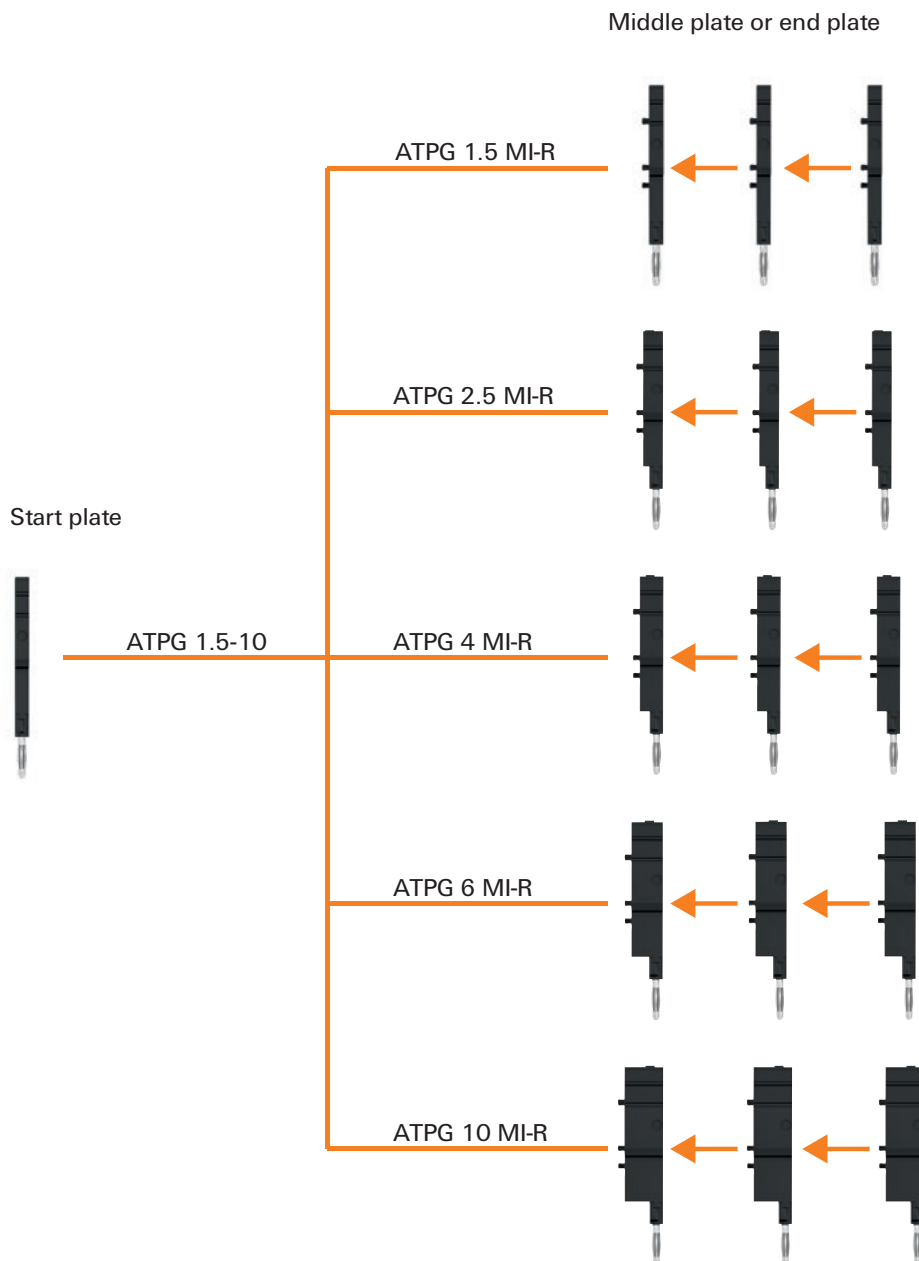

Test adapter

The ATPG test adapter is used as an individual slice and also as a test adapter strip for measurements. The test adapter simply clips onto the terminal and guarantees reliable contact with the live busbar.

Dimensions	
Width / Length / Height	mm
Stripping length	mm
Rated data	
Rated voltage	V
Rated current	A
for wire cross-section	mm ²
Clamped conductors (H05V/H07V)	
Solid / Stranded	mm ²
Flexible / Flexible with ferrule	mm ²
Ordering data	
	1-pole
	3-pole
	5-pole
Note	

ATPG 1.5-10

Start plate



Width / Length / Height	mm	3.5 / / 18.5
Stripping length	mm	6
Rated data		
Rated voltage	V	
Rated current	A	0.2
for wire cross-section	mm ²	1.5
Clamped conductors (H05V/H07V)		
Solid / Stranded	mm ²	0.5...1.5
Flexible / Flexible with ferrule	mm ²	0.5...1.5 / 0.5...1
Ordering data		
Type	Qty.	Order No.
ATPG 1.5-10 L	50	1991890000
Note		

ATPG 1.5 MI-R

Middle plate or end plate



Width / Length / Height	mm	3.5 / / 18.5
Stripping length	mm	6
Rated data		
Rated voltage	V	
Rated current	A	0.2
for wire cross-section	mm ²	1.5
Clamped conductors (H05V/H07V)		
Solid / Stranded	mm ²	0.5...1.5
Flexible / Flexible with ferrule	mm ²	0.5...1.5 / 0.5...1
Ordering data		
Type	Qty.	Order No.
ATPG 1.5 MI-R	50	1991880000
Note		

ATPG 2.5 MI-R

Middle plate or end plate



Width / Length / Height	mm	5.1 / / 18.5
Stripping length	mm	6
Rated data		
Rated voltage	V	
Rated current	A	0.2
for wire cross-section	mm ²	1.5
Clamped conductors (H05V/H07V)		
Solid / Stranded	mm ²	0.5...1.5
Flexible / Flexible with ferrule	mm ²	0.5...1.5 / 0.5...1
Ordering data		
Type	Qty.	Order No.
ATPG 2.5 MI-R	50	1991960000
ATPG 2.5/3	25	2041190000
ATPG 2.5/5	25	2041180000
Note		

Test adapter

The ATPG test adapter is used as an individual slice and also as a test adapter strip for measurements. The test adapter simply clips onto the terminal and guarantees reliable contact with the live busbar.

Dimensions	
Width / Length / Height	mm
Stripping length	mm
Rated data	
Rated voltage	V
Rated current	A
for wire cross-section	mm ²
Clamped conductors (H05V/H07V)	
Solid / Stranded	mm ²
Flexible / Flexible with ferrule	mm ²
Ordering data	
	1-pole
	3-pole
	5-pole
Note	

ATPG 4 MI-R-10

Middle plate or end plate



Width / Length / Height	mm	6.1 / / 18.5
Stripping length	mm	6
Rated data		
Rated voltage	V	
Rated current	A	0.2
for wire cross-section	mm ²	1.5
Clamped conductors (H05V/H07V)		
Solid / Stranded	mm ²	0.5...1.5
Flexible / Flexible with ferrule	mm ²	0.5...1.5 / 0.5...1
Ordering data		
Type	Qty.	Order No.
ATPG 4 MI-R	50	1991860000
Note		

ATPG 6 MI-R

Middle plate or end plate



Width / Length / Height	mm	7.9 / / 18.5
Stripping length	mm	6
Rated data		
Rated voltage	V	
Rated current	A	0.2
for wire cross-section	mm ²	1.5
Clamped conductors (H05V/H07V)		
Solid / Stranded	mm ²	0.5...1.5
Flexible / Flexible with ferrule	mm ²	0.5...1.5 / 0.5...1
Ordering data		
Type	Qty.	Order No.
ATPG 6 MI-R	50	1991930000
Note		

ATPG 10 MI-R

Middle plate or end plate



Width / Length / Height	mm	9.9 / / 18.5
Stripping length	mm	6
Rated data		
Rated voltage	V	
Rated current	A	0.2
for wire cross-section	mm ²	1.5
Clamped conductors (H05V/H07V)		
Solid / Stranded	mm ²	0.5...1.5
Flexible / Flexible with ferrule	mm ²	0.5...1.5 / 0.5...1
Ordering data		
Type	Qty.	Order No.
ATPG 10 MI-R	50	1991870000
Note		





AAM 1.5 YE FLASH



Dimensions	
Width / Height / Depth	mm
Continuous operating temp., min.	-40 °C
Continuous operating temp., max.	100 °C
Material	polyamide
UL 94 flammability rating	V-2
Ordering data	
	yellow
Note	

Type	Qty.	Order No.
AAM 1.5 YE FLASH	40	2635520000

AAM 2.5 YE FLASH



Dimensions	
Width / Height / Depth	mm
Continuous operating temp., min.	-40 °C
Continuous operating temp., max.	100 °C
Material	polyamide
UL 94 flammability rating	V-2
Ordering data	
	yellow
Note	

Type	Qty.	Order No.
AAM 2.5 YE FLASH	40	2635550000

AAM 4 YE FLASH



Dimensions	
Width / Height / Depth	mm
Continuous operating temp., min.	-40 °C
Continuous operating temp., max.	100 °C
Material	polyamide
UL 94 flammability rating	V-2
Ordering data	
	yellow
Note	

Type	Qty.	Order No.
AAM 4 YE FLASH	40	2635560000

AAM 6 YE FLASH



Dimensions	
Width / Height / Depth	mm
Continuous operating temp., min.	-40 °C
Continuous operating temp., max.	100 °C
Material	polyamide
UL 94 flammability rating	V-2
Ordering data	
	yellow
Note	

Type	Qty.	Order No.
AAM 6 YE FLASH	40	2635570000

AAM 10 YE FLASH



Dimensions	
Width / Height / Depth	mm
Continuous operating temp., min.	-40 °C
Continuous operating temp., max.	100 °C
Material	polyamide
UL 94 flammability rating	V-2
Ordering data	
	yellow
Note	

Type	Qty.	Order No.
AAM 10 YE FLASH	40	2635580000

AAM 16 YE FLASH



Dimensions	
Width / Height / Depth	mm
Continuous operating temp., min.	-40 °C
Continuous operating temp., max.	100 °C
Material	polyamide
UL 94 flammability rating	V-2
Ordering data	
	yellow
Note	

Type	Qty.	Order No.
AAM 16 YE FLASH	40	2635590000

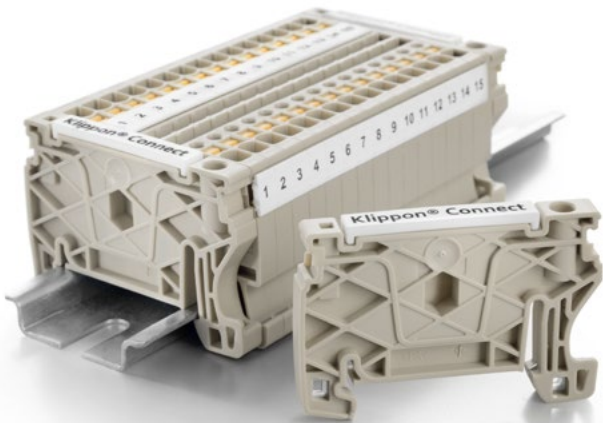

End bracket

AEB 35 SCL/1 VO ...

AEB 35 SCL/1 VO ... DL



Dimensions	
Continuous operating temp., min.	-40 °C
Continuous operating temp., max.	100 °C
Material	polyamide
UL 94 flammability rating	V-0
Ordering data	
	dark beige
	light grey
	black
Note	

Continuous operating temp., min.	-40 °C	
Continuous operating temp., max.	100 °C	
Material	polyamide	
UL 94 flammability rating	V-0	
Ordering data		
Type	Qty.	Order No.
AEB 35 SCL/1 VO	50	2661280000
AEB 35 SCL/1 VO GY	50	2661290000
AEB 35 SCL/1 VO BK	50	2661300000

Continuous operating temp., min.	-40 °C	
Continuous operating temp., max.	100 °C	
Material	Polyamid	
UL 94 flammability rating	V-0	
Ordering data		
Type	Qty.	Order No.
AEB 35 SCL/1 VO DL	50	2570240000
AEB 35 SCL/1 VO GY DL	50	2570260000
AEB 35 SCL/1 VO BK DL	50	2570250000

SnapMark- Marker for multi-tier terminals

SNAPMARK 1

SNAPMARK 1.5



Dimensions	
width / height / depth	mm
Continuous operating temperature, min.	-40 °C
Continuous service temperature, max.	100 °C
Material	polyamide
Flammability class according to UL 94	V-2
Ordering data	
Note	

width / height / depth	mm	3.5 / 6.2 / 4.8
Continuous operating temperature, min.	-40 °C	
Continuous service temperature, max.	100 °C	
Material	polyamide	
Flammability class according to UL 94	V-2	
Ordering data		
Type	Qty.	Order No.
SNAPMARK I	50	1805880000

width / height / depth	mm	5.1 / 8 / 5.8
Continuous operating temperature, min.	-40 °C	
Continuous service temperature, max.	100 °C	
Material	polyamide	
Flammability class according to UL 94	V-2	
Ordering data		
Type	Qty.	Order No.
SNAPMARK I.5	40	2682080000

Spring connection with PUSH IN technology (A-Series)

Overview

Universal range

A

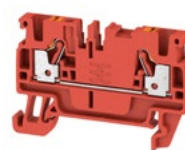
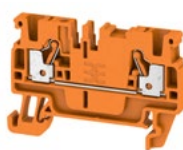

Type	Order No. beige	Order No. blue BL	Order No. orange OR	Order No. red RD
1.5 mm ²	A2C	1552790000	1552820000	2508020000
	A3C	1552740000	1552770000	2534500000
	A4C	1552690000	1552700000	2534430000
2.5 mm ²	A2C	1521850000	1521880000	1521900000
	A3C	1521740000	1521780000	1521800000
	A4C	1521690000	1521700000	1521710000
4 mm ²	A2C	2051180000	2051210000	2051220000
	A3C	2051240000	2051280000	2051300000
	A4C	2051500000	2051520000	2051530000
6 mm ²	A2C	1992110000	1991790000	-
	A3C	1991820000	1991830000	-

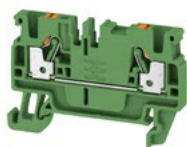

Type	Order No. yellow YL	Order No. green GN	Order No. white WT	Order No. black BK
1.5 mm ²	A2C	2508190000	2508210000	2508170000
	A3C	2534520000	2534480000	2534230000
	A4C	2534450000	2534410000	2534260000
2.5 mm ²	A2C	1521940000	1521950000	1521980000
	A3C	1521840000	1521870000	1521920000
	A4C	1521730000	1521770000	1521820000
4 mm ²	A2C	2051250000	2051260000	2051310000
	A3C	2051340000	2051350000	2051400000
	A4C	2051550000	2051580000	2051660000
6 mm ²	A2C	-	-	-
	A3C	-	-	-

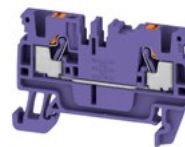

Type	Order No. light grey LTGY	Order No. dark blue DBL	Order No. brown BR	Order No. violet VT
1.5 mm ²	A2C	2508220000	2508180000	-
	A3C	2534490000	2534540000	-
	A4C	2534420000	2534470000	-
2.5 mm ²	A2C	2003110000	2508000000	2876640000
	A3C	2003120000	2534690000	-
	A4C	2003130000	2534740000	-
4 mm ²	A2C	2051330000	2534380000	-
	A3C	2051460000	2534360000	-
	A4C	2051670000	2534400000	-
6 mm ²	A2C	-	-	-
	A3C	-	-	-

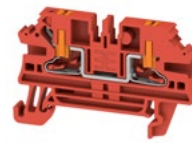
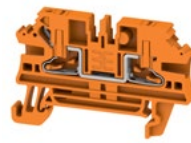
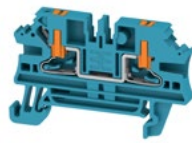

Type	
2.5 mm ²	AL2C
	AL3C
	AL4C
4 mm ²	AL2C
	AL3C
	AL4C

Order No. beige
2847200000
2847330000
2847460000
2847710000
2847720000
2847730000

Order No. blue BL
2847210000
2847340000
2847470000
2871870000
2871990000
2872110000

Order No. orange OR
2847240000
2847370000
2847500000
2871900000
2872020000
2872140000

Order No. red RD
2847230000
2847360000
2847490000
2871890000
2872010000
2872130000



Type	
2.5 mm ²	AL2C
	AL3C
	AL4C
4 mm ²	AL2C
	AL3C
	AL4C

Order No. yellow YL
2847290000
2847420000
2847550000
2871950000
2872070000
2872190000

Order No. green GN
2847250000
2847380000
2847510000
2871910000
2872030000
2872150000

Order No. white WT
2847280000
2847410000
2847540000
2871940000
2872060000
2872180000

Order No. black BK
2847270000
2847400000
2847530000
2871930000
2872050000
2872170000



Type	
2.5 mm ²	AL2C
	AL3C
	AL4C
4 mm ²	AL2C
	AL3C
	AL4C

Order No. light grey LTGY
2847300000
2847430000
2847560000
2871960000
2872080000
2872200000

Order No. dark blue DBL
2847220000
2847350000
2847480000
2871880000
2872000000
2872120000

Order No. brown BR
2847310000
2847440000
2847570000
2871970000
2872090000
2872210000

Order No. violet VT
2847260000
2847390000
2847520000
2871920000
2872040000
2872160000

Flexible in wiring, vibration-resistant in operation

Klippon® Connect with proven tension clamp technology

Whether in machine construction, the automotive industry or railway and shipping: wherever there is a requirement for a particularly vibration-resistant contact, tension clamp technology proves extremely reliable. At the same time, our terminal blocks with proven tension clamp technology are perfect for compact yet manageable panel construction. The wide range with numerous additional functions and pluggable terminal blocks (WeiCoS), the wide clamping range and up to two cross-connection channels make the Z-Series perfectly adaptable to all requirements. Pluggable standard cross-connections enable flexible potential distribution.



Our promise

Klippon® Connect helps you reliably achieve a range of applications. Our terminal blocks with tension clamp technology are impressively compact and flexible. They contribute to highly efficient panel construction and improved productivity.

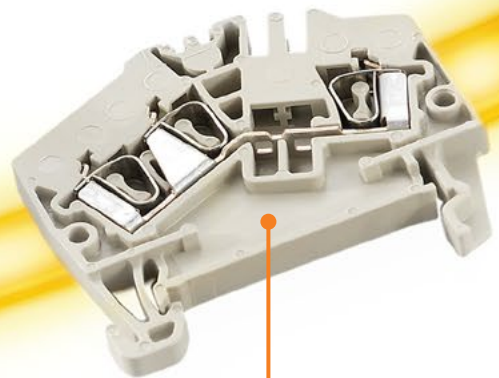

Flexibility

- Pluggable standard cross-connections for flexible potential distribution
- Secure interlocking of all plug-in connectors (WeiCoS)

Time saving

- Integrated test point
- Simple handling thanks to parallel alignment of conductor entry
- Can be wired without special tools

Space saving

- Compact design
- Length reduced by up to 36 percent in roof style

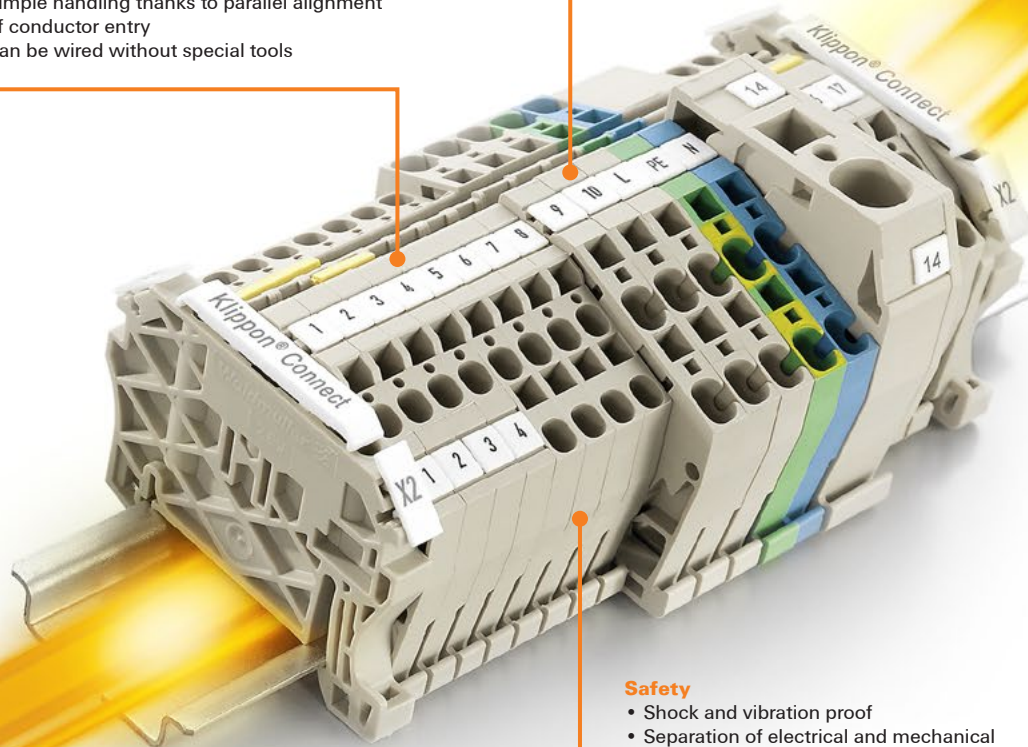
**Safety**

- Shock and vibration proof
- Separation of electrical and mechanical functions
- No-maintenance connection for a safe, gas-tight contacting
- The tension clamp is made of steel with an externally-sprung contact for optimum contact force
- Current bar made of copper for low voltage drops

Overview**Exceptionally practical:**

The Z-Series has an impressive, practical design and comes in two variants: standard and roof. Our standard models cover wire cross-sections from 0.05 to 35 mm². Terminal blocks for wire cross-sections from 0.13 to 16 mm² are available as roof variants. The striking shape of the roof style gives a reduction in length of up to 36 percent compared to standard terminal blocks.

Simple and clear:

Despite their compact width of just 5 mm (2 connections) or 10 mm (4 connections), our block terminals guarantee absolute clarity and ease of handling thanks to the top-entry conductor feeds. This means the wiring is clear even in terminal boxes with restricted space.



Spring connection with tension clamp technology (Z-Series)

Feed-through terminal blocks

ZDUB 2.5-2/2AN/RC

2.5 mm²

Two connections



Width/Height/Depth	mm
max. current / max. cond. cross-section	A/mm ²
Max. clamping range	mm ²

5.1 x 33.5 x 29
30 / 4
0.13...4

Technical data

Rated data	
Rated voltage	V
Rated current	A
for wire cross-section	mm ²
Rated impulse withstand voltage / Pollution severity	
Gauge to IEC 60947-1 / UL 94 flammability rating	
Approvals	
Clamped conductors (H05V/H07V)	
Solid / Stranded	mm ²
Flexible / Flexible with ferrule	mm ²
Stripping length / Blade size	mm/-
Note	

Ordering data

Version	
Central terminals	
	dark beige
	Blue
	yellow
Note	

Accessories

Plug-in cross-connection	
	2-pole
End plate / Partition plate	
	dark beige
	Blue
	orange
Screwdriver	
	Standard
Marking tags	

For detailed information on other accessories and application in the online catalogue

ZDUB 2.5-2/4AN/RC

2.5 mm²

Four connections



10.2 x 33.5 x 29
30 / 4
0.13...4

IEC 60947-7-1 Ex eb II C Gb II 2 G D

IEC	UL	CSA	EN 60079-7
800	600	600	550
24	20	25	21
2.5	AWG 26...12	AWG 26...12	2.5 mm ²
8 kV / 3			
A2 / V-0			

DEMKO16ATEX1808U

Rated connection	
0.5...4	
0.5...2.5 / 0.5...1.5	
10 / 0.6 x 3.5 mm	
Note	
Snap-on clip	

Version	
Central terminals	
	dark beige
	Blue
	yellow
Note	

Type	Qty.	Order No.
ZDUB 2.5-2/4AN/RC	100	1712970000
ZDUB 2.5-2/4AN/RC BL	100	1712980000
ZDUB 2.5-2/4AN/RC GE	100	1713000000
Note		
Diameter of the snap-on clip mounting holes is 3.5 mm when the thickness of the plate is 0.6-961.2 mm.		

Type	Qty.	Order No.
ZDUB 2.5-2/2AN/RC	100	1712820000
ZDUB 2.5-2/2AN/RC BL	100	1712830000
Note		
Diameter of the snap-on clip mounting holes is 3.5 mm when the thickness of the plate is 0.6-961.2 mm.		

Type	Qty.	Order No.
ZQB 2.5-2	24 A 50	1677120000
ZAP ZDUB	50	1704750000
ZAP ZDUB BL	50	1704760000
ZAP ZDUB OR	50	1704770000
SDIS SLIM 0.6X3.5X100	1	2749610000
DEK 5/5 MC NE WS	1000	1609801044
WS 10/5 MC NE WS	720	1635000000

For detailed information on other accessories and application in the online catalogue

ZDUB 2.5-2/2AN/DM

2.5 mm²

Two connections

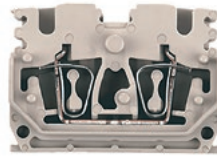

ZDUB 2.5-2/4AN/DM

2.5 mm²

Four connections



Width/Height/Depth	mm
max. current / max. cond. cross-section	A/mm ²
Max. clamping range	mm ²

5.1 x 33.5 x 24	
30 / 4	
0.13...4	

10.2 x 33.5 x 24	
30 / 4	
0.13...4	

Technical data

Rated data	
Rated voltage	V
Rated current	A
for wire cross-section	mm ²
Rated impulse withstand voltage / Pollution severity	Gauge to IEC 60947-1 / UL 94 flammability rating
Approvals	
Clamped conductors (H05V/H07V)	
Solid / Stranded	mm ²
Flexible / Flexible with ferrule	mm ²
Stripping length / Blade size	mm/-
Note	

IEC 60947-7-1				Ex eb II		II 2 G D
				C Gb		
IEC	UL	CSA	EN 60079-7			
800	600	600	550			
24	20	25	21			
2.5	AWG 26...12	AWG 26...12	2.5 mm ²			
				8 kV / 3		
				A2 / V-0		
				DEMKO16ATEX1808U		
Rated connection						
0.5...4						
0.5...2.5						
10 / 0.6 x 3.5 mm						
Direct mounting						

IEC 60947-7-1				Ex eb II		II 2 G D
				C Gb		
IEC	UL	CSA	EN 60079-7			
800	600	600	550			
24	20	25	21			
2.5	AWG 26...12	AWG 26...12	2.5 mm ²			
				8 kV / 3		
				A2 / V-0		
				DEMKO16ATEX1808U		
Rated connection						
0.5...4						
0.5...2.5 / 0.5...1.5						
10 / 0.6 x 3.5 mm						
Direct mounting						

Ordering data

Version	
End terminals	
	dark beige
	Blue
	yellow
Central terminals	
	dark beige
	Blue
	yellow
	orange
Note	

Type	Qty.	Order No.
ZDUB 2.5-2/2AN/DB	100	1704500000
ZDUB 2.5-2/2AN/DB GE	100	1704530000
ZDUB 2.5-2/2AN/DM	100	1704350000
ZDUB 2.5-2/2AN/DM BL	100	1704360000
ZDUB 2.5-2/2AN/DM GE	100	1704380000
ZDUB 2.5-2/2AN/DM OR	100	1704370000

Type	Qty.	Order No.
ZDUB 2.5-2/4AN/DB	100	1704690000
ZDUB 2.5-2/4AN/DB BL	100	1704700000
ZDUB 2.5-2/4AN/DB GE	100	1704720000
ZDUB 2.5-2/4AN/DM	100	1704540000
ZDUB 2.5-2/4AN/DM BL	100	1704550000
ZDUB 2.5-2/4AN/DM GE	100	1704570000
ZDUB 2.5-2/4AN/DM OR	100	1704560000

Accessories

Plug-in cross-connection	2-pole
End plate / Partition plate	dark beige
	Blue
	orange
Mounting blocks	dark beige
Screwdriver	Standard
Mounting foot for TS15 & TS35	dark beige
Marking tags	

Type	Qty.	Order No.
ZDB 2.5-2	24 A 50	1677120000
ZAP ZDUB	50	1704750000
ZAP ZDUB BL	50	1704760000
ZAP ZDUB OR	50	1704770000
ZBB ZDUB	50	1704740000
SDIS SLIM 0.6X3.5X100	1	2749610000
MOFU 15/35 ZDUB	50	1723660000
DEK 5/5 MC NE WS	1000	1609801044
WS 10/5 MC NE WS	720	1635000000

Type	Qty.	Order No.
ZDB 2.5-2	24 A 50	1677120000
ZAP ZDUB	50	1704750000
ZAP ZDUB BL	50	1704760000
ZAP ZDUB OR	50	1704770000
ZBB ZDUB	50	1704740000
SDIS SLIM 0.6X3.5X100	1	2749610000
MOFU 15/35 ZDUB	50	1723660000
DEK 5/5 MC NE WS	1000	1609801044
WS 10/5 MC NE WS	720	1635000000

For detailed information on other accessories and application in the online catalogue



Spring connection with tension clamp technology (Z-Series)
Feed-through terminal blocks

Universal range

A

ZDUB 2.5-2/2AN/TS15

2.5 mm²

Two connections



ZDUB 2.5-2/4AN/TS15

2.5 mm²

Four connections



Width/Height/Depth	mm
max. current / max. cond. cross-section	A/mm ²
Max. clamping range	mm ²

5.1 x 33.5 x 31
30 / 4
0.13...4

10.2 x 33.5 x 31
30 / 4
0.13...4

Technical data

Rated data	
Rated voltage	V
Rated current	A
for wire cross-section	mm ²
Rated impulse withstand voltage / Pollution severity	Gauge to IEC 60947-1 / UL 94 flammability rating
Approvals	
Clamped conductors (H05V/H07V)	
Solid / Stranded	mm ²
Flexible / Flexible with ferrule	mm ²
Stripping length / Blade size	mm/-
Note	

IEC 60947-7-1 Ex eb II C Gb II 2 G D

IEC	UL	CSA	EN 60079-7
800	600	600	550
24	20	25	21
2.5	AWG 26...12	AWG 26...12	2.5 mm ²

8 kV / 3
A2 / V-0

DEMKO16ATEX1808U

Rated connection
0.5...4
0.5...2.5 / 0.5...1.5
10 / 0.6 x 3.5 mm

TS 15 - block construction

IEC 60947-7-1 Ex eb II C Gb II 2 G D

IEC	UL	CSA	EN 60079-7
800	600	600	550
24	20	25	21
2.5	AWG 26...12	AWG 26...12	2.5 mm ²

8 kV / 3
A2 / V-0

DEMKO16ATEX1808U

Rated connection
0.5...4
0.5...2.5 / 0.5...1.5
10 / 0.6 x 3.5 mm

TS 15 - block construction

Ordering data

Version	
	dark beige
	Blue
	Orange
Note	

Type	Qty.	Order No.
ZDUB 2.5-2/2AN/15	100	1712750000
ZDUB 2.5-2/2AN/15 BL	100	1712760000
ZDUB 2.5-2/2AN/15 OR	100	1712770000

Type	Qty.	Order No.
ZDUB 2.5-2/4AN/15	100	1712780000
ZDUB 2.5-2/4AN/15 BL	100	1712790000
ZDUB 2.5-2/4AN/15 OR	100	1712800000

Accessories

Plug-in cross-connection	
	2-pole
	10-pole
	2-pole
End plate / Partition plate	
	dark beige
	Blue
	orange
End bracket	
	beige
Screwdriver	
	Standard
Marking tags	

Type	Qty.	Order No.
ZQB 2.5-2	24 A 50	1677120000
ZAP ZDUB	50	1704750000
ZAP ZDUB BL	50	1704760000
ZAP ZDUB OR	50	1704770000
ZEW 15	20	7920340000
SDIS SLIM 0.6X3.5X100	1	2749610000
DEK 5/5 MC NE WS	1000	1609801044
WS 10/5 MC NE WS	720	1635000000
DEK 5/5 MM WS	800	2007110000

Type	Qty.	Order No.
ZQB 2.5-2	24 A 50	1677120000
ZAP ZDUB	50	1704750000
ZAP ZDUB BL	50	1704760000
ZAP ZDUB OR	50	1704770000
ZEW 15	20	7920340000
SDIS SLIM 0.6X3.5X100	1	2749610000
DEK 5/5 MC NE WS	1000	1609801044
WS 10/5 MC NE WS	720	1635000000
DEK 5/5 MM WS	800	2007110000

For detailed information on other accessories and application in the online catalogue

The terminal blocks are cross-connected when using the ZQB 2.5 (1677120000).

ZDUA 2.5-2

2.5 mm²

Two connections



5.1 x 35 x 30
30 / 4
0.13...4



IEC 60947-7-1 Ex eb II C Gb II 2 G D

IEC	UL	CSA	EN 60079-7
500	600	600	352
24	20	20	20
2.5	AWG 26...12	AWG 26...12	4 mm ²

6 kV / 3
A2 / V-0

DEMKO16ATEX1808U

Rated connection
0.5...2.5 / 0.5...2.5
0.5...2.5 / 0.5...2.5
10 / 0.6 x 3.5 mm

TS 15 - sliced construction

Type	Qty.	Order No.
ZDUA 2.5-2	100	1720920000
ZDUA 2.5-2 BL	100	1720930000
ZDUA 2.5-2 OR	100	1720940000

Type	Qty.	Order No.
ZQV 2.5N/2	24 A 60	1527540000
ZQV 2.5N/10	24 A 20	1527690000
ZAP/TW ZDUA	50	1720960000
ZAP/TW ZDUA BL	50	1720970000
ZAP/TW ZDUA OR	50	1720980000
ZEW 15	20	7920340000
SDIS SLIM 0.6X3.5X100	1	2749610000
DEK 5/5 MC NE WS	1000	1609801044
WS 10/5 MC NE WS	720	1635000000
DEK 5/5 MM WS	800	2007110000

ZDUA 2.5-2N

2.5 mm²

Two connections

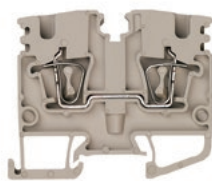

5.1 x 42.5 x 35
30 / 4
0.13...4



IEC 60947-7-1

IEC	UL	CSA	EN 60079-7
800	600	600	600
24	20	20	20
2.5	AWG 26...12	AWG 26...12	

8 kV / 3
A2 / V-0

Rated connection
0.5...2.5 / 0.5...2.5
0.5...2.5 / 0.5...2.5
10 / 0.6 x 3.5 mm

TS 15 - sliced construction

Type	Qty.	Order No.
ZDUA 2.5-2N	100	1808200000

Type	Qty.	Order No.
ZQV 2.5N/2	24 A 60	1527540000
ZQV 2.5N/10	24 A 20	1527690000
ZAP/TW ZDUA2.5-2N	50	1808170000
ZEW 15	20	7920340000
SDIS SLIM 0.6X3.5X100	1	2749610000
DEK 5/5 MC NE WS	1000	1609801044
WS 10/5 MC NE WS	720	1635000000
DEK 5/5 MM WS	800	2007110000



Modular design

A

This mini-terminal family in tension clamp technology can be used to assemble individual blocks with 2- and 4-pole terminals.

An individual colour scheme for individual connection groups allows visual differentiation between different circuits.

With a structural width of only 5 mm (2 connections) or 10 mm (4 connections), the TOP connection system guarantees clearly organised wiring of circuits, even in terminal boxes with restricted space.

There are three different marking options for quick and clear identification of each terminal.

Made of Weidmüller's top quality WEMID insulation, all block terminals comply with requirements for a V0 flammability class to UL94.

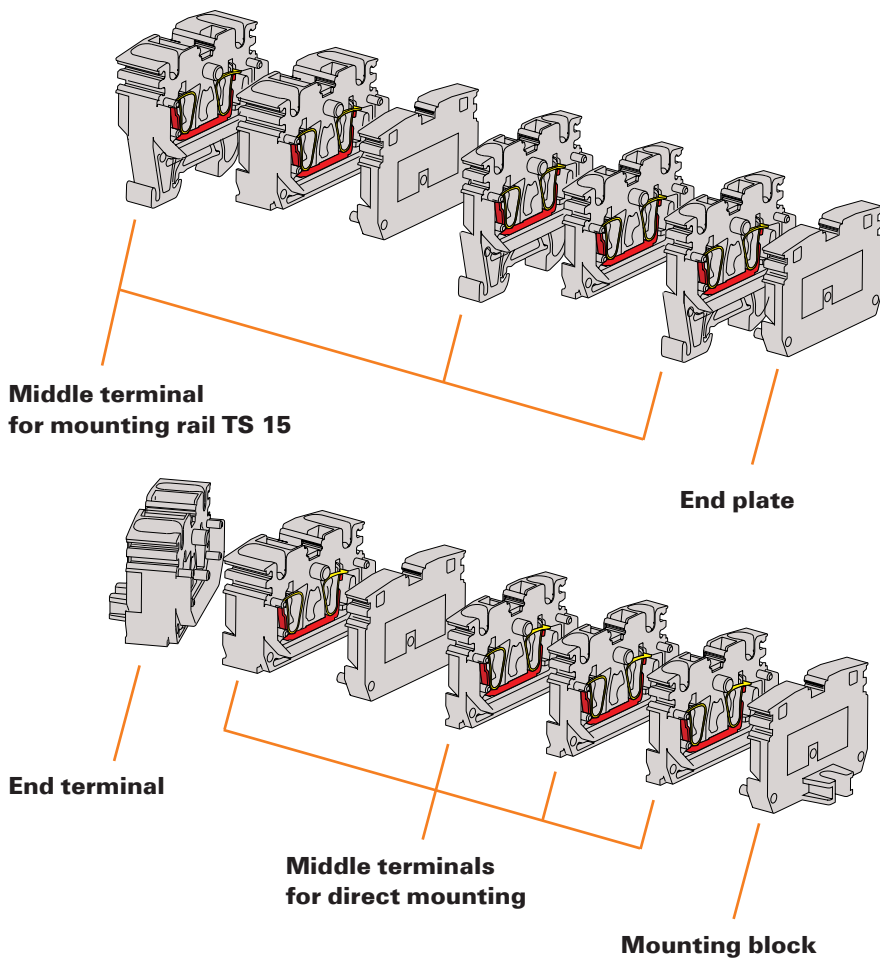

Individual blocks are put together from **middle terminals** and an end plate for the open side. Screw fastening involves the first middle terminal and the **end plate** being replaced by end terminals for fastening purposes. With the other fastening variations, **middle terminals with means of fastening** are integrated within the block or a **mounting foot (MOFU)** is used for fitting to the mounting rail.

... with 4 different means of fastening

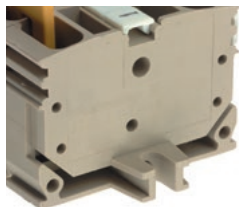

Direct mounting with screw fastening on mounting plate

The fastening terminals on the right and left of the terminal block are mounted using M3 screws. Central fastening is not possible in this case.

ZDUB 2.5-2 DM

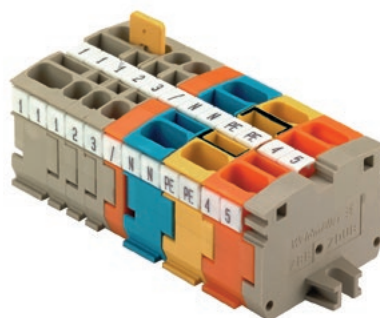

Clip-on fastening on mounting plates

The terminals are simply clipped onto mounting plates 0.6 – 1.2 mm thick with the clips in the 3.5 mm holes. The open side of the terminal is closed by an end plate.

ZDUB 2.5-2 RC



**Drilling plan:
ZDUB/2.5-2/2AN**

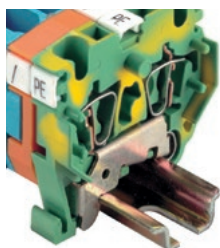
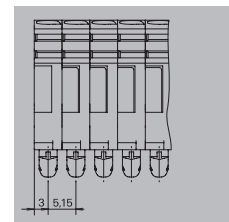

Fitting on mounting rail TS 15

For clipping on mounting rail TS 15. The open side of the terminal is closed by an end plate.

ZPEB 2.5-2 TS 15

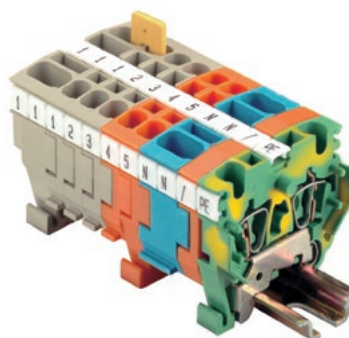

ZDUB 2.5-2/4AN

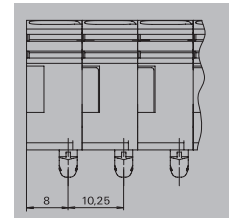

Mounting foot for mounting rail TS 15/35

The mounting foot can be used for clipping terminal blocks consisting only of middle terminals either to TS 15 or TS 35 mounting rails.

MOFU TS 15/35

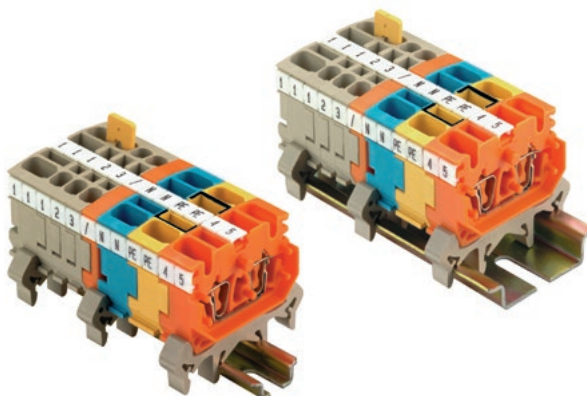

Spring connection with tension clamp technology (Z-Series)
Feed-through terminal blocks

ZDU 1.5 **1.5 mm²**

Two connections

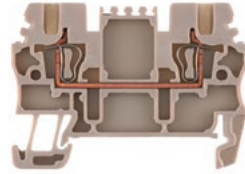

Width/Height/Depth	mm
max. current / max. cond. cross-section	A/mm ²
Max. clamping range	mm ²

3.5 x 51.5 x 36.5	
17.5 / 1.5	
0.05...1.5	

Technical data

Rated data	
Rated voltage	V
Rated current	A
for wire cross-section	mm ²
Rated impulse withstand voltage / Pollution severity	
Gauge to IEC 60947-1 / UL 94 flammability rating	
Approvals	
Clamped conductors (H05V/H07V)	
Solid / Stranded	mm ²
Flexible / Flexible with ferrule	mm ²
Stripping length / Blade size	mm/-
Note	

IEC 60947-7-1 Ex eb II C Gb II 2 G D

IEC	UL	CSA	EN 60079-7
500	300	300	550
17.5	15	20	17
1.5	AWG 26...14	AWG 26...14	1.5 mm ²

6 kV / 3
B1 / V-0

DEMKO15ATEX1467U

Rated connection	
0.5...1.5	
0.5...1.5 / 0.5...1	
10 / 0.4 x 2.0 mm	

Ordering data

Version	
	dark beige
	Blue
Note	

Type	Qty.	Order No.
ZDU 1.5	100	1775480000
ZDU 1.5 BL	100	1775490000

Accessories

Plug-in cross-connection	
	2-pole
	4-pole
	10-pole
End plate / Partition plate	
	dark beige
	Blue
End bracket	
	dark beige
Test adapter	
	Standard
	With spigot
Screwdriver	
	Standard
Reducing sleeves	
	for conductors < 0.5 mm ² / AWG 20
	for conductors < 1.0 mm ² / AWG 18
Cover	
	With lightning flash symbol
Marking tags	

Type	Qty.	Order No.
ZQV 1.5/2	17.5 A 60	1776120000
ZQV 1.5/10	17.5 A 20	1776200000
ZAP/TW ZDU1.5/2AN	20	1776030000
ZAP/TW ZDU1.5/2AN BL	20	1776040000
ZEW 35	20	9540000000
SDS 0.4x2.0x60	1	2749260000
ZRH 1.5S/1	500	1781950000
ZAD 7/4	20	1781940000
DEK 5/3.5 MC NE WS	500	1755270000
WS 12/3.5 MC NE WS	600	1778270000
DEK 5/3.5 MM WS	1000	2007100000

For detailed information on other accessories and application in the online catalogue

ZDU 1.5/3 AN **1.5 mm²**

Three connections

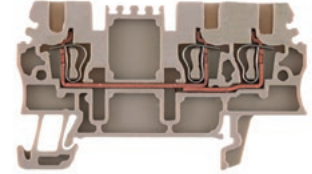

3.5 x 63.5 x 36.5	
17.5 / 1.5	
0.05...1.5	

IEC 60947-7-1 Ex eb II C Gb II 2 G D

IEC	UL	CSA	EN 60079-7
500	300	300	550
17.5	15	20	15
1.5	AWG 26...14	AWG 26...14	1.5 mm ²

6 kV / 3
B1 / V-0

DEMKO15ATEX1467U

Rated connection	
0.5...1.5	
0.5...1.5 / 0.5...1	
10 / 0.4 x 2.0 mm	

Type	Qty.	Order No.
ZDU 1.5/3AN	100	1775530000
ZDU 1.5/3AN BL	100	1775540000

Type	Qty.	Order No.
ZQV 1.5/2	17.5 A 60	1776120000
ZQV 1.5/10	17.5 A 20	1776200000
ZAP/TW ZDU1.5/3AN	20	1776060000
ZAP/TW ZDU1.5/3AN BL	20	1776070000
ZEW 35	20	9540000000
SDS 0.4x2.0x60	1	2749260000
ZRH 1.5S/1	500	1781950000
ZAD 7/4	20	1781940000
DEK 5/3.5 MC NE WS	500	1755270000
WS 12/3.5 MC NE WS	600	1778270000
DEK 5/3.5 MM WS	1000	2007100000

For detailed information on other accessories and application in the online catalogue

ZDU 1.5/4 AN

1.5 mm²

Four connections

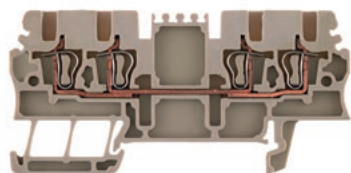

3.5 x 75.5 x 36.5
17.5 / 1.5
0.05...1.5

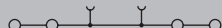

Ex eb II

C Gb



II 2 G D

IEC 60947-7-1

IEC	UL	CSA	EN 60079-7
500	300	300	550
17.5	15	20	17
1.5	AWG 26...14	AWG 26...14	1.5 mm ²

6 kV / 3

B1 / V-0



DEMKO15ATEX1467U

Rated connection

0.5...1.5

0.5...1.5 / 0.5...1

10 / 0.4 x 2.0 mm

ZDU 1.5 2x2AN

1.5 mm²

2 x 2 connections

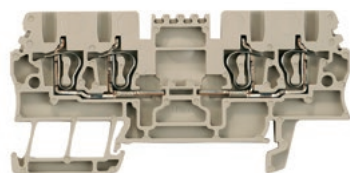

3.5 x 75.5 x 36.5
17.5 / 1.5
0.05...1.5

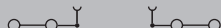

IEC 60947-7-1

IEC	UL	CSA	EN 60079-7
500			
17.5			
1.5			

6 kV / 3

B1 / V-0



Rated connection

0.5...1.5

0.5...1.5 / 0.5...1.5

10 / 0.4 x 2.0 mm

ZEI 6

6 mm²

Supply terminal

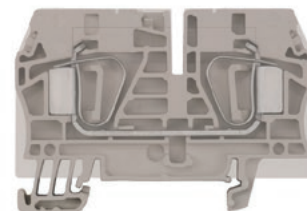

10 x 65 x 45
57 / 10
0.5...10



IEC 60947-7-1

IEC	UL	CSA	EN 60079-7
500			
41			
6			

8 kV / 4

A5 / V-0



Rated connection

0.5...10

0.5...10 / 0.5...6

13 / 1.0 x 5.5 mm

Type	Qty.	Order No.
ZDU 1.5/4AN	100	1775580000
ZDU 1.5/4AN BL	100	1775600000

Type	Qty.	Order No.
ZDU 1.5/2X2AN	100	1826970000

Type	Qty.	Order No.
ZEI 6	20	1791190000

End plate is integrated.

Type	Qty.	Order No.
ZQV 1.5/2	17.5 A 60	1776120000
ZQV 1.5/10	17.5 A 20	1776200000
ZAP/TW ZDU1.5/4AN	20	1776090000
ZAP/TW ZDU1.5/4AN BL	20	1776100000
ZEW 35	20	9540000000
SDS 0.4X2.0X60	1	2749260000
ZRH 1.5S/1	500	1781950000
ZAD 7/4	20	1781940000
DEK 5/3.5 MC NE WS	500	1755270000
WS 12/3.5 MC NE WS	600	1778270000
DEK 5/3.5 MM WS	1000	2007100000

Type	Qty.	Order No.
ZQV 1.5/2	17.5 A 60	1776120000
ZQV 1.5/10	17.5 A 20	1776200000
ZAP/TW ZDU1.5/4AN	20	1776090000
ZAP/TW ZDU1.5/4AN BL	20	1776100000
ZEW 35	20	9540000000
SDS 0.4X2.0X60	1	2749260000
ZRH 1.5S/1	500	1781950000
ZAD 7/4	20	1781940000
DEK 5/3.5 MC NE WS	500	1755270000
WS 12/3.5 MC NE WS	600	1778270000
DEK 5/3.5 MM WS	1000	2007100000

Type	Qty.	Order No.
ZQV 1.5/2	17.5 A 60	1776120000
ZQV 1.5/10	17.5 A 20	1776200000
ZEW 35	20	9540000000
ZTA 3 ZDU6	9 A 25	1654050000
SDIS SLIM 0.8X4.0X100	1	2749620000
ZAD 3/4	20	1609120000
WS 12/6 MC NE WS	600	1609900000



Spring connection with tension clamp technology (Z-Series)
Feed-through terminal blocks

ZDU 2.5

2.5 mm²

Two connections

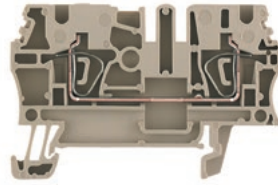

ZDU 2.5/3AN

2.5 mm²

Three connections

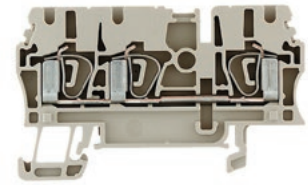

Width/Height/Depth	mm
max. current / max. cond. cross-section	A/mm ²
Max. clamping range	mm ²

5.1 x 59.5 x 38.5
30 / 4
0.05...4

5.1 x 64.5 x 38.5
31 / 4
0.05...4

Technical data

Rated data	
Rated voltage	V
Rated current	A
for wire cross-section	mm ²
Rated impulse withstand voltage / Pollution severity	
Gauge to IEC 60947-1 / UL 94 flammability rating	
Approvals	
Clamped conductors (H05V/H07V)	
Solid / Stranded	mm ²
Flexible / Flexible with ferrule	mm ²
Stripping length / Blade size	mm/-
Note	

IEC 60947-7-1 Ex eb II C Gb II 2 G D

IEC	UL	CSA	EN 60079-7
800	600	600	550
24	25	27	22
2.5	AWG 30...12	AWG 26...12	4 mm ²
8 kV / 3			
A3 / V-0			
DEMKO15ATEX1467U			
Rated connection			
0.5...4			
0.5...4 / 0.5...2.5			
10 / 0.6 x 3.5 mm			

IEC 60947-7-1 Ex eb II C Gb II 2 G D

IEC	UL	CSA	EN 60079-7
800	600	600	550
24	25	27	22
2.5	AWG 30...12	AWG 26...12	4 mm ²
8 kV / 3			
A3 / V-0			
DEMKO15ATEX1467U			
Rated connection			
0.5...4			
0.5...4 / 0.5...2.5			
10 / 0.6 x 3.5 mm			

Ordering data

Version	
	dark beige
	Blue
Note	

Type	Qty.	Order No.
ZDU 2.5	100	1608510000
ZDU 2.5 BL	100	1608520000

Type	Qty.	Order No.
ZDU 2.5/3AN	100	1608540000
ZDU 2.5/3AN BL	100	1608550000

Accessories

Plug-in cross-connection	
	2-pole
	4-pole
	10-pole
End plate / Partition plate	
	dark beige
	Blue
End bracket	
	dark beige
Test adapter	
	Standard
	With spigot
Screwdriver	
	Standard
Reducing sleeves	
	for conductors < 0.5 mm ² / AWG 20
	for conductors < 1.0 mm ² / AWG 18
Cover	
	With lightning flash symbol
Marking tags	

Type	Qty.	Order No.
ZQV 2.5/2	24 A 60	1608860000
ZQV 2.5/10	24 A 20	1608940000
ZAP/TW 1	50	1608740000
ZAP/TW 1 BL	50	1608750000
ZEW 35	20	9540000000
ZTA 1	9 A 25	1609040000
ZTA 1/ZA	9 A 25	1609050000
SDIS SLIM 0.6X3.5X100	1	2749610000
ZRH 2.5/1 WS	1000	1614300000
ZRH 2.5/2 GR/V0	1000	1614290000
ZAD 1/4	20	1609110000
DEK 5/5 MC NE WS	1000	1609801044
WS 10/5 MC NE WS	720	1635000000
DEK 5/5 MM WS	800	2007110000

Type	Qty.	Order No.
ZQV 2.5/2	24 A 60	1608860000
ZQV 2.5/10	24 A 20	1608940000
ZAP/TW 2 DB	50	1608770000
ZAP/TW 2 BL	50	1608780000
ZEW 35	20	9540000000
ZTA 1	9 A 25	1609040000
ZTA 1/ZA	9 A 25	1609050000
SDIS SLIM 0.6X3.5X100	1	2749610000
ZRH 2.5/1 WS	1000	1614300000
ZRH 2.5/2 GR/V0	1000	1614290000
ZAD 1/4	20	1609110000
DEK 5/5 MC NE WS	1000	1609801044
WS 10/5 MC NE WS	720	1635000000
DEK 5/5 MM WS	800	2007110000

For detailed information on other accessories and application in the online catalogue

ZDU 2.5/4AN

2.5 mm²

Four connections

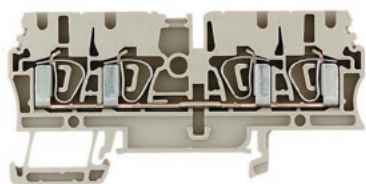

5.1 x 79.5 x 38.5
27 / 4
0.05...4



IEC 60947-7-1 Ex eb II C Gb II 2 G D

IEC	UL	CSA	EN 60079-7
800	600	600	550
24	25	27	22
2.5	AWG 30...12	AWG 26...12	4 mm ²

8 kV / 3
A3 / V-0

DEMKO15ATEX1467U

Rated connection

0.5...4
0.5...4 / 0.5...2.5
10 / 0.6 x 3.5 mm

Type	Qty.	Order No.
ZDU 2.5/4AN	100	1608570000
ZDU 2.5/4AN BL	100	1608580000

Type	Qty.	Order No.
ZQV 2.5/2	24 A 60	1608860000
ZQV 2.5/10	24 A 20	1608940000
ZAP/TW 3	50	1608800000
ZAP/TW 3 BL	50	1608810000
ZEW 35	20	9540000000
ZTA 1	9 A 25	1609040000
ZTA 1/ZA	9 A 25	1609050000
SDIS SLIM 0.6X3.5X100	1	2749610000
ZRH 2.5/1 WS	1000	1614300000
ZRH 2.5/2 GR/V0	1000	1614290000
ZAD 1/4	20	1609110000
DEK 5/5 MC NE WS	1000	1609801044
WS 10/5 MC NE WS	720	1635000000
DEK 5/5 MM WS	800	2007110000

ZDU 2.5/2x2AN

2.5 mm²

Two potentials feasible

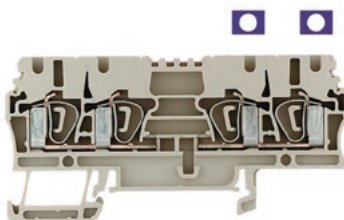

5.1 x 79.5 x 38.5
30 / 4
0.05...4

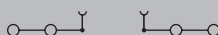

IEC 60947-7-1 Ex eb II C Gb II 2 G D

IEC	UL	CSA	EN 60079-7
800	600	600	550
24	25	27	21
2.5	AWG 26...12	AWG 26...12	4 mm ²

8 kV / 3
A3 / V-0

DEMKO15ATEX1567U

Rated connection

0.5...4
0.5...4 / 0.5...2.5
10 / 0.6 x 3.5 mm

Type	Qty.	Order No.
ZDU 2.5/2X2AN	100	1608600000
ZDU 2.5/2X2AN BL	100	1608610000

Type	Qty.	Order No.
ZAP/TW 3	50	1608800000
ZAP/TW 3 BL	50	1608810000
ZEW 35	20	9540000000
ZTA 1	9 A 25	1609040000
ZTA 1/ZA	9 A 25	1609050000
SDIS SLIM 0.6X3.5X100	1	2749610000
ZRH 2.5/1 WS	1000	1614300000
ZRH 2.5/2 GR/V0	1000	1614290000
ZAD 1/4	20	1609110000
DEK 5/5 MC NE WS	1000	1609801044
WS 10/5 MC NE WS	720	1635000000



Spring connection with tension clamp technology (Z-Series)

Feed-through terminal blocks

Universal range

A

ZDU 4 4 mm²

Two connections

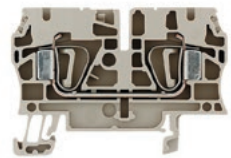

ZDU 4/3 AN 4 mm²

Three connections

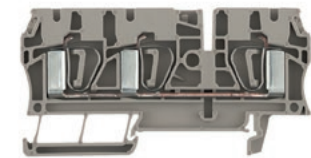

Width/Height/Depth	mm
max. current / max. cond. cross-section	A/mm ²
Max. clamping range	mm ²

6.1 x 62 x 43	
41 / 6	
0.13...6	

6.1 x 83.5 x 43	
41 / 6	
0.13...6	

Technical data

Rated data	
Rated voltage	V
Rated current	A
for wire cross-section	mm ²
Rated impulse withstand voltage / Pollution severity	
Gauge to IEC 60947-1 / UL 94 flammability rating	
Approvals	
Clamped conductors (H05V/H07V)	
Solid / Stranded	mm ²
Flexible / Flexible with ferrule	mm ²
Stripping length / Blade size	mm/-
Note	

IEC 60947-7-1 Ex eb II C Gb II 2 G D

IEC	UL	CSA	EN 60079-7
800		600	550
32		35	28
4		AWG 26...10	6 mm ²
8 kV / 3			
A4 / V-0			
DEMKO15ATEX1467U			
Rated connection			
0.5...6 / 0.5...6			
0.5...6 / 0.5...4			
12 / 0.6 x 3.5 mm			

IEC 60947-7-1 Ex eb II C Gb II 2 G D

IEC	UL	CSA	EN 60079-7
800		600	550
32		35	28
4		AWG 26...10	6 mm ²
8 kV / 3			
A4 / V-0			
DEMKO15ATEX1467U			
Rated connection			
0.5...6 / 0.5...6			
0.5...6 / 0.5...4			
12 / 0.6 x 3.5 mm			

Ordering data

Version	
	dark beige
	Blue
Note	

Type	Qty.	Order No.
ZDU 4	100	1632050000
ZDU 4 BL	100	1632060000

Type	Qty.	Order No.
ZDU 4/3AN	50	7904180000
ZDU 4/3AN BL	50	7904190000

Accessories

Plug-in cross-connection	
	2-pole
	4-pole
	10-pole
End plate / Partition plate	
	dark beige
	Blue
End bracket	
	dark beige
Test adapter	
	Standard
	With spigot
Screwdriver	
	Standard
Reducing sleeves	
	for conductors < 0.5 mm ² / AWG 20
	for conductors < 1.0 mm ² / AWG 18
Cover	
	With lightning flash symbol
Marking tags	

Type	Qty.	Order No.
ZQV 4/2 GE	32 A 60	1608950000
ZQV 4/10 GE	32 A 20	1609030000
ZAP/TW 4	50	1632090000
ZAP/TW 4 BL	50	1632100000
ZEW 35	20	9540000000
ZTA 2 ZDU4	9 A 25	1609060000
ZTA 2/ZA ZDU4	9 A 25	1609070000
SDIS SLIM 0.6X3.5X100	1	2749610000
ZRH 4/1 WS	1000	1636640000
ZAD 2/4	20	1609080000
DEK 5/6 MC NE WS	1000	1609820000
WS 10/6 MC NE WS	600	1828450000
DEK 5/6 MM WS	600	2007120000

Type	Qty.	Order No.
ZQV 4/2 GE	32 A 60	1608950000
ZQV 4/10 GE	32 A 20	1609030000
ZAP/TW 4/3AN	20	7904100000
ZAP/TW 4/3AN BL	20	7904110000
ZEW 35	20	9540000000
ZTA 2 ZDU4	9 A 25	1609060000
ZTA 2/ZA ZDU4	9 A 25	1609070000
SDIS SLIM 0.6X3.5X100	1	2749610000
ZRH 4/1 WS	1000	1636640000
ZAD 2/4	20	1609080000
DEK 5/6 MC NE WS	1000	1609820000
WS 8/6 MM WS	600	2007160000
DEK 5/6 MM WS	600	2007120000

For detailed information on other accessories and application in the online catalogue

For detailed information on other accessories and application in the online catalogue

ZDU 4/4 AN

4 mm²

Four connections

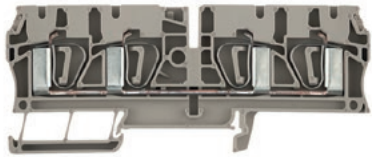

6.1 x 104.5 x 43
41 / 6
0.13...6

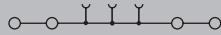

IEC 60947-7-1 Ex eb II C Gb II 2 G D

IEC	UL	CSA	EN 60079-7
800		600	550
32		35	28
4		AWG 26...10	6 mm ²

8 kV / 3
A4 / V-0

DEMKO15ATEX1467U

Rated connection

0.5...6 / 0.5...6
0.5...6 / 0.5...4
12 / 0.6 x 3.5 mm

Type	Qty.	Order No.
ZDU 4/4AN	50	7904290000
ZDU 4/4AN BL	50	7904300000

Type	Qty.	Order No.
ZQV 4/2 GE	32 A 60	1608950000
ZQV 4/10 GE	32 A 20	1609030000
ZAP/TW4/4AN	20	7904210000
ZAP/TW4/4AN BL	20	7904220000
ZEW 35	20	9540000000
ZTA 2 ZDU4	9 A 25	1609060000
ZTA 2/ZA ZDU4	9 A 25	1609070000
SDIS SLIM 0.6X3.5X100	1	2749610000
ZRH 4/1 WS	1000	1636640000
ZAD 2/4	20	1609080000
DEK 5/6 MC NE WS	1000	1609820000
WS 12/6 MC NE WS	600	1609900000

ZDU 6

6 mm²

Two connections

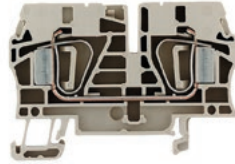

8.1 x 65 x 45
57 / 10
0.22...10

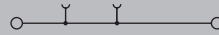

IEC 60947-7-1 Ex eb II C Gb II 2 G D

IEC	UL	CSA	EN 60079-7
800	600	600	550
41	50	50	39
6	AWG 22...8	AWG 20...8	10 mm ²

8 kV / 3
A5 / V-0

DEMKO15ATEX1467U

Rated connection

0.5...10
0.5...10 / 0.5...6
13 / 1.0 x 5.5 mm

Type	Qty.	Order No.
ZDU 6	50	1608620000
ZDU 6 BL	50	1608630000

1000 V DC rated voltage tested.

Type	Qty.	Order No.
ZQV 6/2 GE	41 A 60	1627850000
ZQV 6/4 GE	41 A 60	1627870000
ZAP/TW 5	50	1608830000
ZAP/TW 5 BL	50	1608840000
ZEW 35	20	9540000000
ZTA 3 ZDU6	9 A 25	1654050000
SDS 1.0X5.5X150	1	2749380000
ZAD 3/4	20	1609120000
DEK 5/8 MC NE WS	800	1856740000
WS 12/6 MC NE WS	600	1609900000
DEK 5/8 MM WS	500	2007130000
WS 8/8 MM WS	500	2007170000

ZDU 6/3 AN

6 mm²

Three connections

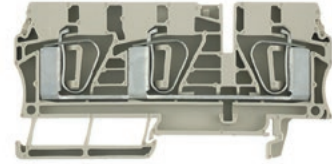

8.1 x 90 x 45
57 / 10
0.22...10

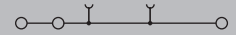

IEC 60947-7-1 Ex eb II C Gb II 2 G D

IEC	UL	CSA	EN 60079-7
800	600	600	550
41	50	50	39
6	AWG 22...8	AWG 20...8	10 mm ²

8 kV / 3
A5 / V-0

DEMKO15ATEX1467U

Rated connection

0.5...10
0.5...6 / 0.5...6
13 / 1.0 x 5.5 mm

Type	Qty.	Order No.
ZDU 6/3AN	50	7907410000
ZDU 6/3AN BL	50	7907420000

Type	Qty.	Order No.
ZQV 6/2 GE	41 A 60	1627850000
ZQV 6/4 GE	41 A 60	1627870000
ZAP/TW6/3AN	20	7907370000
ZAP/TW6/3AN BL	20	7907380000
ZEW 35	20	9540000000
ZTA 3 ZDU6	9 A 25	1654050000
SDS 1.0X5.5X150	1	2749380000
ZAD 3/4	20	1609120000
DEK 5/8 MC NE WS	800	1856740000
WS 12/6 MC NE WS	600	1609900000
DEK 5/8 MM WS	500	2007130000
WS 8/8 MM WS	500	2007170000

Spring connection with tension clamp technology (Z-Series)
Feed-through terminal blocks

Universal range

A

ZDU 10

10 mm²

Two connections

ZDU 10/3AN

10 mm²

Three connections

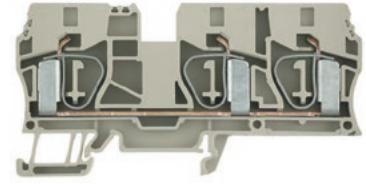
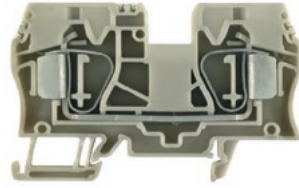

Width/Height/Depth	mm
max. current / max. cond. cross-section	A/mm ²
Max. clamping range	mm ²

10 x 73.5 x 49.5
72 / 16
1.31...16

10 x 99 x 49.5
57 / 16
1.31...16

Technical data

Rated data	
Rated voltage	V
Rated current	A
for wire cross-section	mm ²
Rated impulse withstand voltage / Pollution severity	
Gauge to IEC 60947-1 / UL 94 flammability rating	
Approvals	
Clamped conductors (H05V/H07V)	
Solid / Stranded	mm ²
Flexible / Flexible with ferrule	mm ²
Stripping length / Blade size	mm/-
Note	

IEC 60947-7-1

Ex eb II
C Gb II 2 G D

IEC	UL	CSA	EN 60079-7
1000	600	600	690
57	60	55	51
10	AWG 16...6	AWG 16...6	16 mm ²

8 kV / 3
A6 / V-0

DEMKO15ATEX1467U

Rated connection	
1.5...16 / 1.5...16	
1.5...10 / 1.5...10	
18 / 1.0 x 5.5 mm	

Cross-connection of ZDU 10 and ZDU 16 is possible using the ZDV 16-10. Cross-connection of ZDU 10 and ZDU 35 is possible using the ZDV 35-10.

IEC 60947-7-1

Ex eb II
C Gb II 2 G D

IEC	UL	CSA	EN 60079-7
800	600	600	690
57	60	55	51
10	AWG 16...6	AWG 16...6	16 mm ²

8 kV / 3
A6 / V-0

DEMKO15ATEX1467U

Rated connection	
1.5...16 / 1.5...16	
1.5...10 / 1.5...10	
18 / 1.0 x 5.5 mm	

Cross-connection of ZDU 10 and ZDU 16 is possible using the ZDV 16-10. Cross-connection of ZDU 10 and ZDU 35 is possible using the ZDV 35-10.

Ordering data

Version	
	dark beige
	Blue
Note	

Type	Qty.	Order No.
ZDU 10	25	1746750000
ZDU 10 BL	25	1746760000

Type	Qty.	Order No.
ZDU 10/3AN	20	1767690000
ZDU 10/3AN BL	20	1767700000

Accessories

Plug-in cross-connection	
	2-pole
	4-pole
End plate / Partition plate	
	dark beige
	Blue
End bracket	
	dark beige
Testing / Checking	
	Test plug
Screwdriver	
	Standard
Cover	
	With lightning flash symbol
Marking tags	

Type	Qty.	Order No.
ZDV 10/2	57 A 25	1739680000
ZAP/TW ZDU10	20	1748660000
ZAP/TW ZDU10 BL	20	1764110000
ZEW 35	20	9540000000
PS 2.3 RT	20 mA 20	0180400000
SDS 1.0X5.5X150	1	2749380000
ZAD 4/5	20	1746730000
DEK 5/5 MC NE WS	1000	1609801044
WS 12/5 MC NE WS	720	1609860000

Type	Qty.	Order No.
ZDV 10/2	57 A 25	1739680000
ZAP/TW 10/16	20	1749580000
ZAP/TW 10/16 BL	20	1768520000
ZEW 35	20	9540000000
PS 2.3 RT	20 mA 20	0180400000
SDS 1.0X5.5X150	1	2749380000
ZAD 4/5	20	1746730000
DEK 5/5 MC NE WS	1000	1609801044
WS 12/5 MC NE WS	720	1609860000

For detailed information on other accessories and application in the online catalogue

ZDU 16

16 mm²

Two connections

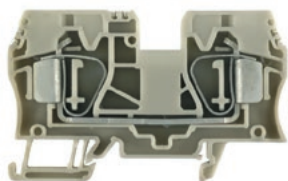

12.1 x 82.5 x 50.5
98 / 25
1.5...25



Ex eb II
C Gb II 2 G D

IEC 60947-7-1

IEC	UL	CSA	EN 60079-7
1000	600	600	690
76	65	65	68
16	AWG 14...4	AWG 14...4	25 mm ²

8 kV / 3

A7 / V-0

DEMKO15ATEX1467U

Rated connection

1.5...16 / 1.5...25

1.5...16 / 1.5...16

18 / 1.0 x 5.5 mm

Cross-connection of ZDU 16 and ZDU 35 is possible using the ZDV 35-16. Cross-connection of ZDU 10 and ZDU 16 is possible using the ZDV 16-10.

Type	Qty.	Order No.
ZDU 16	25	1745230000
ZDU 16 BL	25	1745240000

Type	Qty.	Order No.
ZQV 16/2	76 A 25	1739690000
ZAP/TW ZDU 16	20	1745150000
ZAP/TW ZDU 16 BL	20	1764100000
ZEW 35	20	9540000000
PS 2.3 RT	20 mA 20	0180400000
SDS 1.0X5.5X150	1	2749380000
ZAD 5/5	20	1745210000
DEK 5/5 MC NE WS	1000	1609801044
WS 15/5 MC NE WS	480	1609880000

ZDU 16/3 AN

16 mm²

Three connections

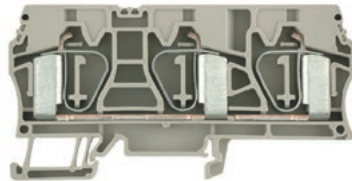

12.1 x 99 x 50.5
76 / 25
1.5...25



Ex eb II
C Gb II 2 G D

IEC 60947-7-1

IEC	UL	CSA	EN 60079-7
800	600	600	690
76	65	65	66
16	AWG 14...4	AWG 14...4	25 mm ²

8 kV / 3

A7 / V-0

DEMKO15ATEX1467U

Rated connection

1.5...16 / 1.5...25

1.5...16 / 1.5...16

18 / 1.0 x 5.5 mm

Type	Qty.	Order No.
ZDU 16/3AN	20	1768320000
ZDU 16/3AN BL	20	1768330000

Type	Qty.	Order No.
ZAP/TW 10/16	20	1749580000
ZAP/TW 10/16 BL	20	1768520000
ZEW 35	20	9540000000
PS 2.3 RT	20 mA 20	0180400000
SDS 1.0X5.5X150	1	2749380000
ZAD 5/5	20	1745210000
DEK 5/5 MC NE WS	1000	1609801044
WS 15/5 MC NE WS	480	1609880000

ZEI 16

16 mm²

Supply terminal

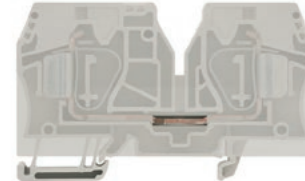

14.7 x 82.5 x 50.5
76 / 25
1.5...25



IEC 60947-7-1

IEC	UL	CSA	EN 60079-7
500	600	600	
76	65	65	
16	AWG 14...4	AWG 14...4	

8 kV / 3

A7 / V-0

DEMKO15ATEX1467U

Rated connection

1.5...16 / 1.5...25

1.5...16 / 1.5...16

18 / 1.0 x 5.5 mm

Type	Qty.	Order No.
ZEI 16	20	1745350000
ZEI 16 BL	20	1766240000

Integrated end plate.

Type	Qty.	Order No.
ZQV 2.5/2	24 A 60	1608860000
ZQV 6/4 GE	41 A 60	1627870000
ZEW 35	20	9540000000
PS 2.3 RT	20 mA 20	0180400000
SDS 1.0X5.5X150	1	2749380000
ZAD 5/5	20	1745210000
DEK 5/5 MC NE WS	1000	1609801044
WS 15/5 MC NE WS	480	1609880000



Spring connection with tension clamp technology (Z-Series)

Feed-through terminal blocks

ZDU 35

35 mm²

Two connections

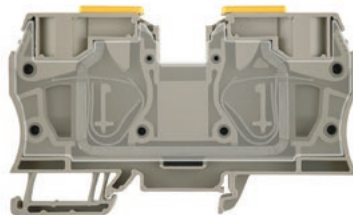

Width/Height/Depth	mm
max. current / max. cond. cross-section	A/mm ²
Max. clamping range	mm ²

16 x 100.5 x 58.5
125 / 35
2.5...35



Technical data

Rated data	
Rated voltage	V
Rated current	A
for wire cross-section	mm ²
Rated impulse withstand voltage / Pollution severity	
Gauge to IEC 60947-1 / UL 94 flammability rating	
Approvals	
Clamped conductors (H05V/H07V)	
Solid / Stranded	mm ²
Flexible / Flexible with ferrule	mm ²
Stripping length / Blade size	mm/-

IEC 60947-7-1			
Ex eb II C Gb II 2 G D			
IEC	UL	CSA	EN 60079-7
800	600	600	690
125	120	120	110
35	AWG 12...2	AWG 12...2	35 mm ²
8 kV / 3			
A8 / V-0			
DEMKO15ATEX1467U			
Rated connection			
2.5...16 / 2.5...35			
2.5...35 / 2.5...35			
25 / 1.0 x 5.5 mm			

Note

Cross-connection of ZDU 10 and ZDU 35 is possible using the ZDV 35-10. Cross-connection of ZDU 16 and ZDU 35 is possible using the ZDV 35-16.

Ordering data

Version	dark beige
	Blue
Note	

Type	Qty.	Order No.
ZDU 35	10	1739620000
ZDU 35 BL	10	1739630000

Accessories

Plug-in cross-connection	2-pole
	4-pole
End plate / Partition plate	dark beige
	Blue
End bracket	dark beige
Testing / Checking	Test plug
Screwdriver	Standard
Cover	With lightning flash symbol
Marking tags	

Type	Qty.	Order No.
ZDV 35/2	125 A 10	1739700000
ZEW 35	20	9540000000
SDS 1.0X5.5X150	1	2749380000
ZAD 6/5	20	1752620000
DEK 5/5 MC NE WS	1000	1609801044
WS 15/5 MC NE WS	480	1609880000

For detailed information on other accessories and application in the online catalogue



Spring connection with tension clamp technology (Z-Series)
Feed-through terminal blocks

ZDU 2.5-2

2.5 mm²

Two connections

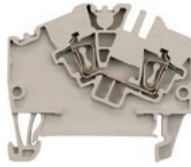

ZDU 2.5-2/3AN

2.5 mm²

Three connections



Width/Height/Depth	mm
max. current / max. cond. cross-section	A/mm ²
Max. clamping range	mm ²

5.1 x 50.5 x 43	
24 / 2.5	
0.13...2.5	

5.1 x 50.5 x 43	
24 / 2.5	
0.13...2.5	

Technical data

Rated data	
Rated voltage	V
Rated current	A
for wire cross-section	mm ²
Rated impulse withstand voltage / Pollution severity	
Gauge to IEC 60947-1 / UL 94 flammability rating	
Approvals	
Clamped conductors (H05V/H07V)	
Solid / Stranded	mm ²
Flexible / Flexible with ferrule	mm ²
Stripping length / Blade size	mm/-
Note	

IEC 60947-7-1 Ex eb II C Gb II 2 G D

IEC	UL	CSA	EN 60079-7
800	600	600	550
24	24	24	21
2.5	AWG 26...12	AWG 26...12	4 mm ²
8 kV / 3			
A2 / V-0			
DEMKO16ATEX1808U			
Rated connection			
0.5...2.5 / 2.5...0.5			
0.5...2.5 / 0.5...1.5			
10 / 0.6 x 3.5 mm			

IEC 60947-7-1 Ex eb II C Gb II 2 G D

IEC	UL	CSA	EN 60079-7
800	600	600	550
24	20	23	21
2.5	AWG 26...12	AWG 26...14	4 mm ²
8 kV / 3			
A2 / V-0			
DEMKO16ATEX1808U			
Rated connection			
0.5...2.5 / 2.5...0.5			
0.5...2.5 / 0.5...1.5			
10 / 0.6 x 3.5 mm			

Ordering data

Version	
	dark beige
	Blue
Note	

Type	Qty.	Order No.
ZDU 2.5-2	100	1772060000
ZDU 2.5-2 BL	100	1772070000

Type	Qty.	Order No.
ZDU 2.5-2/3AN	100	1706010000
ZDU 2.5-2/3AN BL	100	1706040000

Accessories

Plug-in cross-connection	
	2-pole
	10-pole
End plate / Partition plate	
	dark beige
	Blue
End bracket	
	dark beige
Test adapter	
	With spigot
Screwdriver	
	Standard
Reducing sleeves	
	for conductors < 0.5 mm ² / AWG 20
	for conductors < 1.0 mm ² / AWG 18
Cover	
	With lightning flash symbol
Marking tags	

Type	Qty.	Order No.
ZQV 2.5/2	24 A 60	1608860000
ZQV 2.5/10	24 A 20	1608940000
ZAP/TW7	50	1706110000
ZAP/TW7 BL	50	1706120000
ZEW 35	20	9540000000
ZTA 4	11 A 25	1688110000
SDIS SLIM 0.6X3.5X100	1	2749610000
ZRH 1.5H/1	1000	1678810000
ZRH 1.5H/2	1000	1678800000
ZAD 1/4-2 GE	20	1764560000
DEK 5/5 MC SDR	200	1609810000
DEK 5/5 MM WS	800	2007110000

Type	Qty.	Order No.
ZQV 2.5/2	24 A 60	1608860000
ZQV 2.5/10	24 A 20	1608940000
ZAP/TW7	50	1706110000
ZAP/TW7 BL	50	1706120000
ZEW 35	20	9540000000
ZTA 4	11 A 25	1688110000
SDIS SLIM 0.6X3.5X100	1	2749610000
ZRH 1.5H/1	1000	1678810000
ZRH 1.5H/2	1000	1678800000
ZAD 1/4-2 GE	20	1764560000
DEK 5/5 MC SDR	200	1609810000
DEK 5/5 MM WS	800	2007110000

For detailed information on other accessories and application in the online catalogue

ZDU 2.5-2/4AN

2.5 mm²

Four connections



5.1 x 50.5 x 43
24 / 2.5
0.13...2.5

IEC 60947-7-1 Ex eb II C Gb II 2 G D

IEC	UL	CSA	EN 60079-7
800	600	600	550
24	20	23	21
2.5	AWG 26...12	AWG 26...14	4 mm ²

8 kV / 3
A2 / V-0

DEMK016ATEX1808U

Rated connection

0.5...2.5 / 2.5...0.5
0.5...2.5 / 0.5...1.5
10 / 0.6 x 3.5 mm

Type	Qty.	Order No.
ZDU 2.5-2/4AN	100	1706060000
ZDU 2.5-2/4AN BL	100	1706070000

Type	Qty.	Order No.
ZQB 2.5-2	24 A 50	1677120000

ZAP/TW7	50	1706110000
ZAP/TW7 BL	50	1706120000

ZEW 35	20	9540000000
--------	----	------------

ZTA 4	11 A 25	1688110000
-------	---------	------------

SDIS SLIM 0.6X3.5X100	1	2749610000
-----------------------	---	------------

ZRH 1.5H/1	1000	1678810000
ZRH 1.5H/2	1000	1678800000

ZAD 1/4-2 GE	20	1764560000
--------------	----	------------

DEK 5/5 MC SDR	200	1609810000
DEK 5/5 MM WS	800	2007110000

ZDU 4-2

4 mm²

Two connections



6.1 x 61.5 x 45.5
32 / 6
0.13...6

IEC 60947-7-1 Ex eb II C Gb II 2 G D

IEC	UL	CSA	EN 60079-7
800	600	600	440
32	33	35	29
4	AWG 26...10	AWG 26...10	6 mm ²

8 kV / 3
A3 / V-0

DEMK016ATEX1808U

Rated connection

0.5...6
0.5...4 / 0.5...4
10 / 0.6 x 3.5 mm

Type	Qty.	Order No.
ZDU 4-2/2AN	50	1770370000
ZDU 4-2/2AN BL	50	1770840000

Type	Qty.	Order No.
ZQV 4/2 GE	32 A 60	1608950000
ZQV 4/10 GE	32 A 20	1609030000

ZAP ZDU4-2	50	1770400000
ZAP ZDU4-2 BL	50	1770880000

ZEW 35	20	9540000000
--------	----	------------

ZTA 6/ZA	17.5 A 25	1780660000
----------	-----------	------------

SDIS SLIM 0.6X3.5X100	1	2749610000
-----------------------	---	------------

ZAD 1/4	20	1609110000
---------	----	------------

WS 12/6 MC NE WS	600	1609900000
DEK 5/6 MM WS	600	2007120000
DEK 5/6 MC NE WS	1000	1609820000

ZDU 4-2/3AN

4 mm²

Three connections



6.1 x 61.5 x 45.5
38 / 6
0.13...6

IEC 60947-7-1 Ex eb II C Gb II 2 G D

IEC	UL	CSA	EN 60079-7
800	600	600	440
32	33	35	29
4	AWG 26...10	AWG 26...10	6 mm ²

8 kV / 3
A3 / V-0

DEMK016ATEX1808U

Rated connection

0.5...6
0.5...4 / 0.5...4
10 / 0.6 x 3.5 mm

Type	Qty.	Order No.
ZDU 4-2/3AN	50	1770360000
ZDU 4-2/3AN BL	50	1770860000

Type	Qty.	Order No.
ZQV 4/2 GE	32 A 60	1608950000
ZQV 4/10 GE	32 A 20	1609030000

ZAP ZDU4-2	50	1770400000
ZAP ZDU4-2 BL	50	1770880000

ZEW 35	20	9540000000
--------	----	------------

ZTA 6/ZA	17.5 A 25	1780660000
----------	-----------	------------

SDIS SLIM 0.6X3.5X100	1	2749610000
-----------------------	---	------------

ZAD 1/4	20	1609110000
---------	----	------------

WS 12/6 MC NE WS	600	1609900000
DEK 5/6 MM WS	600	2007120000



Spring connection with tension clamp technology (Z-Series)

Feed-through terminal blocks

ZDU 4-2/3AN LSC

4 mm²

Three connections



Width/Height/Depth	mm
max. current / max. cond. cross-section	A/mm ²
Max. clamping range	mm ²

6.1 x 61.5 x 45.5	
38 / 6	
0.13...6	

Technical data

Rated data	
Rated voltage	V
Rated current	A
for wire cross-section	mm ²
Rated impulse withstand voltage / Pollution severity	
Gauge to IEC 60947-1 / UL 94 flammability rating	
Approvals	
Clamped conductors (H05V/H07V)	
Solid / Stranded	mm ²
Flexible / Flexible with ferrule	mm ²
Stripping length / Blade size	mm/-
Note	

Ordering data

Version	
	dark beige
	Blue
Note	

Accessories

Plug-in cross-connection	
	2-pole
	4-pole
	10-pole
End plate / Partition plate	
	dark beige
	Blue
End bracket	
	dark beige
Test adapter	
	With spigot
Screwdriver	
	Standard
Cover	
	With lightning flash symbol
Marking tags	

For detailed information on other accessories and application in the online catalogue

ZDU 4-2/4AN

4 mm²

Four connections



6.1 x 75.1 x 45.5	
32 / 6	
0.13...6	

IEC 60947-7-1	Ex eb II C Gb	II 2 G D	
IEC	UL	CSA	EN 60079-7
800	600	600	440
32	33	35	29
4	AWG 26...10	AWG 26...10	6 mm ²
8 kV / 3			
A3 / V-0			
DEMKO16ATEX1808U			
Rated connection			
0.5...6			
0.5...4 / 0.5...4			
10 / 0.6 x 3.5 mm			
Note			

Type	Qty.	Order No.
ZDU 4-2/4AN	50	1806980000
ZDU 4-2/4AN BL	50	1806990000
Note		

Type	Qty.	Order No.
ZQV 4/2 GE	32 A 60	1608950000
ZQV 4/10 GE	32 A 20	1609030000
ZAP ZDU4-2/4AN	50	1807010000
ZAP ZDU4-2/4AN BL	50	1807020000
ZEW 35	20	9540000000
ZTA 6/ZA	17.5 A 25	1780660000
SDIS SLIM 0.6X3.5X100	1	2749610000
ZAD 1/4	20	1609110000
DEK 5/6 MC NE WS	1000	1609820000
WS 12/6 MC NE WS	600	1609900000
DEK 5/6 MM WS	600	2007120000
Note		

For detailed information on other accessories and application in the online catalogue

ZDU 6-2/2AN

6 mm²

Two connections



8.1 x 68 x 49.5
41 / 10
0.22...10

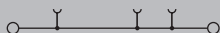

IEC 60947-7-1 Ex eb II C Gb II 2 G D

IEC	UL	CSA	EN 60079-7
800	600	600	550
41	45	50	38
6	AWG 22...8	AWG 20...8	10 mm ²

8 kV / 3
A5 / V-0

DEMKO16ATEX1808U

Rated connection

0.5...10
0.5...10 / 0.5...6
12 / 0.6 x 3.5 mm, 0.8 x 4.0 mm

Type	Qty.	Order No.
ZDU 6-2/2AN	50	1771380000
ZDU 6-2/2AN BL	50	1771390000

Type	Qty.	Order No.
ZQV 6/2 GE	41 A 60	1627850000
ZQV 6/4 GE	41 A 60	1627870000
ZAP ZDU6-2	50	1771440000
ZEW 35	20	9540000000
ZTA 7/ZA	9 A 25	1780670000
SDIS SLIM 0.8X4.0X100	1	2749620000
ZAD 2/4	20	1609080000
DEK 5/8 MC NE WS	800	1856740000
DEK 5/8 MM WS	500	2007130000
WS 8/8 MM WS	500	2007170000

ZDU 6-2/3AN

6 mm²

Three connections



8.1 x 68 x 49.5
41 / 10
0.22...10

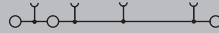

IEC 60947-7-1 Ex eb II C Gb II 2 G D

IEC	UL	CSA	EN 60079-7
800	600	600	550
41	45	50	38
6	AWG 22...8	AWG 20...8	10 mm ²

8 kV / 3
A5 / V-0

DEMKO16ATEX1808U

Rated connection

0.5...10
0.5...10 / 0.5...6
12 / 0.6 x 3.5 mm, 0.8 x 4.0 mm

Type	Qty.	Order No.
ZDU 6-2/3AN	50	1771410000
ZDU 6-2/3AN BL	50	1771420000

Type	Qty.	Order No.
ZQV 6/2 GE	41 A 60	1627850000
ZQV 6/4 GE	41 A 60	1627870000
ZAP ZDU6-2	50	1771440000
ZEW 35	20	9540000000
ZTA 7/ZA	9 A 25	1780670000
SDIS SLIM 0.8X4.0X100	1	2749620000
ZAD 2/4	20	1609080000
DEK 5/8 MC NE WS	800	1856740000
DEK 5/8 MM WS	500	2007130000
WS 8/8 MM WS	500	2007170000

ZEI 16-2/1AN

16 mm²

Supply terminal



14 x 61.5 x 50.5
76 / 25
1.5...25



In accordance with IEC 60947-7-1

IEC	UL	CSA	EN 60079-7
800	600	600	
76	65	65	
16	AWG 14...4	AWG 14...4	

6 kV / 3
A7 / V-0

Rated connection

1.5...10 / 16...25
1.5...16 / 1.5...16
18 / 1.0 x 5.5 mm

Type	Qty.	Order No.
ZEI 16-2/1AN	20	1772940000
ZEI 16-2/1AN BL	20	1772950000

Type	Qty.	Order No.
ZQV 2.5/2	24 A 60	1608860000
ZAP/Z...16-2/1AN	10	1772970000
ZEW 35	20	9540000000
SDS 1.0X5.5X150	1	2749380000
DEK 5/8 MC NE WS	800	1856740000
DEK 5/8 MM WS	500	2007130000



Spring connection with tension clamp technology (Z-Series)
Feed-through terminal blocks

ZDU 2.5N

2.5 mm²

Two connections

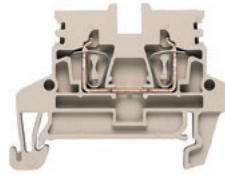

ZDU 2.5N/3AN

2.5 mm²

Three connections

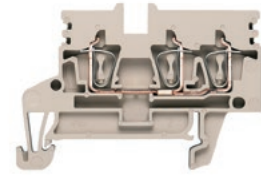

Width/Height/Depth	mm
max. current / max. cond. cross-section	A/mm ²
Max. clamping range	mm ²

5.1 x 50.5 x 38.5
24 / 4
0.05...4

5.1 x 56.5 x 38.5
24 / 4
0.05...4

Technical data

Rated data	
Rated voltage	V
Rated current	A
for wire cross-section	mm ²
Rated impulse withstand voltage / Pollution severity	
Gauge to IEC 60947-1 / UL 94 flammability rating	
Approvals	
Clamped conductors (H05V/H07V)	
Solid / Stranded	mm ²
Flexible / Flexible with ferrule	mm ²
Stripping length / Blade size	mm/-
Note	

IEC 60947-7-1 Ex eb II C Gb II 2 G D

IEC	UL	CSA	EN 60079-7
800	300	300	550
24	20	24	20.5
2.5	AWG 30...12	AWG 30...12	2.5 mm ²
6 kV / 3			
A2 / V-0			
UNDEFINED TEXT			
Rated connection			
0.5...4 / 1.5...2.5			
0.5...2.5 / 0.5...1.5			
10 / 0.6 x 3.5 mm			

IEC 60947-7-1 Ex eb II C Gb II 2 G D

IEC	UL	CSA	EN 60079-7
800	300	300	550
24	20	24	21.5
2.5	AWG 30...12	AWG 30...12	2.5 mm ²
6 kV / 3			
A2 / V-0			
UNDEFINED TEXT			
Rated connection			
0.5...4 / 1.5...2.5			
0.5...2.5 / 0.5...1.5			
10 / 0.6 x 3.5 mm			

Ordering data

Version	
	dark beige
	Blue
Note	

Type	Qty.	Order No.
ZDU 2.5N	50	1933700000
ZDU 2.5N BL	50	1933710000

Type	Qty.	Order No.
ZDU 2.5N/3AN	50	1933720000
ZDU 2.5N/3AN BL	50	1933730000

Accessories

Plug-in cross-connection	
	2-pole
	10-pole
End plate / Partition plate	
	dark beige
End bracket	
	dark beige
Test adapter	
	Standard
	With spigot
Screwdriver	
	Standard
Reducing sleeves	
	for conductors < 0.5 mm ² / AWG 20
	for conductors < 1.0 mm ² / AWG 18
Cover	
	With lightning flash symbol
Marking tags	

Type	Qty.	Order No.
ZQV 2.5/2	24 A 60	1608860000
ZQV 2.5/10	24 A 20	1608940000
ZAP/TW ZDU/ZPE 2.5N	20	1933790000
ZEW 35	20	9540000000
ZTA ZT2.5	17.5 A 25	1827080000
ZTA ZT2.5/ZA	17.5 A 25	1847600000
SDIS SLIM 0.6X3.5X100	1	2749610000
ZRH 1.5H/1	1000	1678810000
ZRH 1.5H/2	1000	1678800000
ZAD 9/4	20	1934160000
DEK 5/5 MC NE WS	1000	1609801044
WS 10/5 M MC NE WS	720	1792000000
WS 8/5 MM WS	800	2007150000

Type	Qty.	Order No.
ZQV 2.5/2	24 A 60	1608860000
ZQV 2.5/10	24 A 20	1608940000
ZAP/TW ZDU/ZPE 2.5N/3AN	50	1933800000
ZEW 35	20	9540000000
ZTA ZT2.5	17.5 A 25	1827080000
ZTA ZT2.5/ZA	17.5 A 25	1847600000
SDIS SLIM 0.6X3.5X100	1	2749610000
ZRH 1.5H/1	1000	1678810000
ZRH 1.5H/2	1000	1678800000
ZAD 9/4	20	1934160000
DEK 5/5 MC NE WS	1000	1609801044
WS 10/5 M MC NE WS	720	1792000000
WS 8/5 MM WS	800	2007150000

For detailed information on other accessories and application in the online catalogue

ZDU 2.5N/4AN

2.5 mm²

Four connections

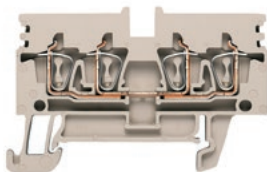

5.1 x 60 x 38.5
24 / 4
0.05...4

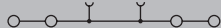

IEC 60947-7-1 Ex eb II
C Gb II 2 G D

IEC	UL	CSA	EN 60079-7
800	300	300	550
24	20	24	21
2.5	AWG 30...12	AWG 30...12	2.5 mm ²

6 kV / 3

A2 / V-0

UNDEFINED TEXT

Rated connection

0.5...4 / 1.5...2.5

0.5...2.5 / 0.5...1.5

10 / 0.6 x 3.5 mm

Type	Qty.	Order No.
ZDU 2.5N/4AN	50	1933740000
ZDU 2.5N/4AN BL	50	1933750000

Type	Qty.	Order No.
ZQV 2.5/2	24 A 60	1608860000
ZQV 2.5/10	24 A 20	1608940000
ZAP/TW ZDU/ZPE 2.5N/4AN	50	1933810000
ZEW 35	20	9540000000
ZTA ZT2.5	17.5 A 25	1827080000
ZTA ZT2.5/ZA	17.5 A 25	1847600000
SDIS SLIM 0.6X3.5X100	1	2749610000
ZRH 1.5H/1	1000	1678810000
ZRH 1.5H/2	1000	1678800000
ZAD 9/4	20	1934160000
DEK 5/5 MC NE WS	1000	1609801044
WS 10/5 M MC NE WS	720	1792000000
WS 8/5 MM WS	800	2007150000



Spring connection with tension clamp technology (Z-Series)

Feed-through terminal blocks

ZDK 1.5

1.5 mm²

Double-level terminal

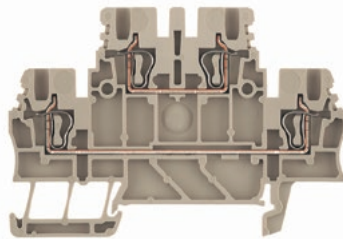

3.5 x 75.5 x 49.5
17.5 / 1.5
0.05...1.5

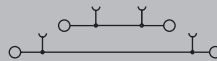

IEC 60947-7-1

IEC	UL	CSA	EN 60079-7
500	300	600	
17.5	10	10	
1.5	AWG 28...16	AWG 28...16	
6 kV / 3			
B1 / V-0			

CE

Rated connection

0.5...1.5
0.5...1.5 / 0.5...1.5
10 / 0.4 x 2.0 mm

ZDK 1.5V

1.5 mm²

Vertically cross-connected double-level terminal

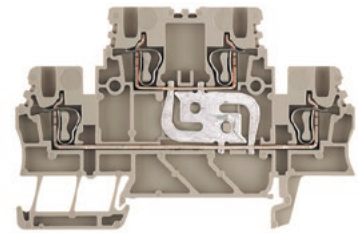

3.5 x 75.5 x 49.5
17.5 / 1.5
0.05...1.5

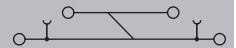

IEC 60947-7-1

IEC	UL	CSA	EN 60079-7
500	300	600	
17.5	10	10	
1.5	AWG 28...16	AWG 28...16	
6 kV / 3			
B1 / V-0			

CE

Rated connection

0.5...1.5
0.5...1.5 / 0.5...1.5
10 / 0.4 x 2.0 mm

Width/Height/Depth	mm
max. current / max. cond. cross-section	A/mm ²
Max. clamping range	mm ²

Technical data

Rated data	
Rated voltage	V
Rated current	A
for wire cross-section	mm ²
Rated impulse withstand voltage / Pollution severity	
Gauge to IEC 60947-1 / UL 94 flammability rating	
Approvals	
Clamped conductors (H05V/H07V)	
Solid / Stranded	mm ²
Flexible / Flexible with ferrule	mm ²
Stripping length / Blade size	mm/-

Note

Ordering data

Version	
	dark beige
	Blue
Note	

Accessories

Plug-in cross-connection	
	2-pole
	10-pole
End plate / Partition plate	
	dark beige
	Blue
End bracket	
	dark beige
Test adapter	
	Standard
	With spigot
Screwdriver	
	Standard
Reducing sleeves	
	for conductors < 0.5 mm ² / AWG 20
	for conductors < 1.0 mm ² / AWG 18
Marking tags	
Cover	
	With lightning flash symbol

Type	Qty.	Order No.
ZDK 1.5	100	1791100000
ZDK 1.5 BL	100	1791110000

Type	Qty.	Order No.	
ZQV 1.5/2	17.5 A	60	1776120000
ZQV 1.5/10	17.5 A	20	1776200000
ZAP/TW ZDK1.5	20	1791160000	
ZAP/TW ZDK1.5 BL	20	1791170000	
ZEW 35	20	9540000000	
SDS 0.4X2.0X60	1	2749260000	
ZRH 1.5S/1	500	1781950000	
DEK 5/3.5 MC NE WS	500	1755270000	
DEK 5/3.5 MM WS	1000	2007100000	
ZAD 7/4	20	1781940000	

Type	Qty.	Order No.
ZDK 1.5V	100	1791130000
ZDK 1.5V BL	50	1791140000

Type	Qty.	Order No.	
ZQV 1.5/2	17.5 A	60	1776120000
ZQV 1.5/10	17.5 A	20	1776200000
ZAP/TW ZDK1.5	20	1791160000	
ZAP/TW ZDK1.5 BL	20	1791170000	
ZEW 35	20	9540000000	
SDS 0.4X2.0X60	1	2749260000	
ZRH 1.5S/1	500	1781950000	
DEK 5/3.5 MC NE WS	500	1755270000	
DEK 5/3.5 MM WS	1000	2007100000	
ZAD 7/4	20	1781940000	

For detailed information on other accessories and application in the online catalogue

ZDK 1.5 DU-PE

1.5 mm²

Double-level terminal (DU-PE)

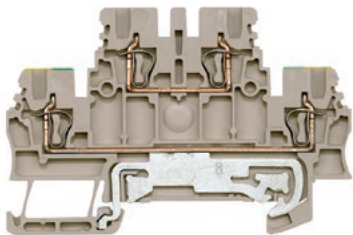

3.5 x 75.5 x 49.5
17.5 / 1.5
0.05...1.5

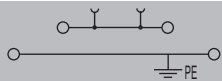

IEC 60947-7-1 (-7-2)

IEC	UL	CSA	EN 60079-7
500	300		
17.5	10		
1.5	AWG 28...16	AWG 28...16	
6 kV / 3			
B1 / V-0			

CE

Rated connection

0.5...1.5
0.5...1.5 / 0.5...1.5
10 / 0.4 x 2.0 mm

Type	Qty.	Order No.
ZDK 1.5DU-PE	100	1791120000

Type	Qty.	Order No.
ZQV 1.5/2	17.5 A	60 1776120000
ZQV 1.5/10	17.5 A	20 1776200000
ZAP/TW ZDK1.5	20	1791160000
ZAP/TW ZDK1.5 BL	20	1791170000
ZEW 35	20	9540000000
SDS 0.4X2.0X60	1	2749260000
ZRH 1.5S/1	500	1781950000
DEK 5/3.5 MC NE WS	500	1755270000
DEK 5/3.5 MM WS	1000	2007100000
ZAD 7/4	20	1781940000



Spring connection with tension clamp technology (Z-Series)
Feed-through terminal blocks

Universal range

A

ZDK 2.5

2.5 mm²

Double-level terminal

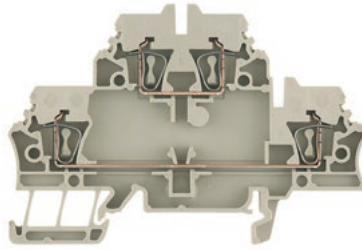

ZDK 2.5 V

2.5 mm²

Vertically cross-connected double-level terminal

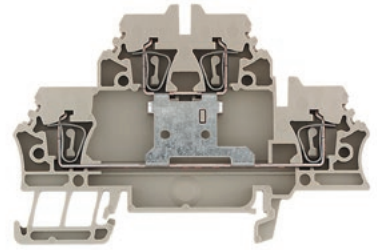

Width/Height/Depth	mm
max. current / max. cond. cross-section	A/mm ²
Max. clamping range	mm ²

5.1 x 79.5 x 53	
20 / 2.5	
0.05...2.5	

5.1 x 79.5 x 53	
20 / 2.5	
0.05...2.5	

Technical data

Rated data	
Rated voltage	V
Rated current	A
for wire cross-section	mm ²
Rated impulse withstand voltage / Pollution severity	
Gauge to IEC 60947-1 / UL 94 flammability rating	
Approvals	
Clamped conductors (H05V/H07V)	
Solid / Stranded	mm ²
Flexible / Flexible with ferrule	mm ²
Stripping length / Blade size	mm/-
Note	

IEC 60947-7-1 Ex eb II C Gb II 2 G D

IEC	UL	CSA	EN 60079-7
500	300		440
20	15		20
2.5	AWG 26...14		2.5 mm ²
6 kV / 3			
A2 / V-0			
DEMKO16ATEX1729U			
Rated connection			
0.5...2.5			
0.5...2.5 / 0.5...2.5			
10 / 0.6 x 3.5 mm			
Note			

IEC 60947-7-1 Ex eb II C Gb II 2 G D

IEC	UL	CSA	EN 60079-7
500	300		440
20	15		20
2.5	AWG 26...14		2.5 mm ²
6 kV / 3			
A2 / V-0			
DEMKO16ATEX1729U			
Rated connection			
0.5...2.5			
0.5...2.5 / 0.5...2.5			
10 / 0.6 x 3.5 mm			
Note			

Ordering data

Version	
	dark beige
	Blue
Note	

Type	Qty.	Order No.
ZDK 2.5	50	1674300000
ZDK 2.5 BL	50	1678630000
ZBS 1 component plug ZBS 1 can be used for LED (1764550000).		

Type	Qty.	Order No.
ZDK 2.5V	50	1689990000
ZDK 2.5V BL	50	1745880000

Accessories

Plug-in cross-connection	
	2-pole
	10-pole
End plate / Partition plate	
	dark beige
	Blue
End bracket	dark beige
Test adapter	
	Standard
	With spigot
Screwdriver	Standard
Reducing sleeves	
	for conductors < 0.5 mm ² / AWG 20
	for conductors < 1.0 mm ² / AWG 18
Marking tags	
Cover	With lightning flash symbol

Type	Qty.	Order No.
ZQV 2.5/2	24 A 60	1608860000
ZQV 2.5/10	24 A 20	1608940000
ZAP/TW ZDK2.5	20	1674730000
ZAP/TW ZDK2.5 BL	20	1748800000
ZEW 35	20	9540000000
ZTA ZDK 2.5	6 A 5	1052660000
ZTA ZDK 2.5/ZA	6 A 5	1052680000
SDIS SLIM 0.6X3.5X100	1	2749610000
ZRH 1.5H/1	1000	1678810000
ZRH 1.5H/2	1000	1678800000
DEK 5/5 MC NE WS	1000	1609801044
WS 12/5 MC NE WS	720	1609860000
DEK 5/5 MM WS	800	2007110000
WS 8/5 MM WS	800	2007150000

Type	Qty.	Order No.
ZQV 2.5/2	24 A 60	1608860000
ZQV 2.5/10	24 A 20	1608940000
ZAP/TW ZDK2.5	20	1674730000
ZAP/TW ZDK2.5 BL	20	1748800000
ZEW 35	20	9540000000
ZTA ZDK 2.5	6 A 5	1052660000
ZTA ZDK 2.5/ZA	6 A 5	1052680000
SDIS SLIM 0.6X3.5X100	1	2749610000
ZRH 1.5H/1	1000	1678810000
ZRH 1.5H/2	1000	1678800000
DEK 5/5 MC NE WS	1000	1609801044
WS 12/5 MC NE WS	720	1609860000
DEK 5/5 MM WS	800	2007110000
WS 8/5 MM WS	800	2007150000

For detailed information on other accessories and application in the online catalogue

ZQV 2.5/1.5 (1720700000) connects the upper and lower layer.

ZDK 2.5 DU-PE

2.5 mm²

Phase - PE conductor

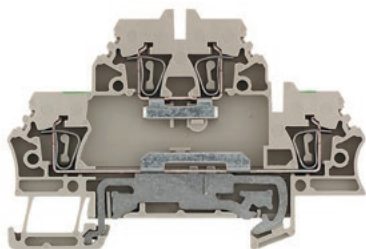

5.1 x 79.5 x 53
24 / 2.5
0.05...2.5

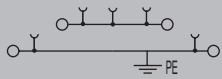

Ex eb II
C Gb II 2 G D

IEC 60947-7-1 (-7-2)

IEC	UL	CSA	EN 60079-7
500	300		352
20	15		20
2.5	AWG 26...14		2.5 mm ²

6 kV / 3
A2 / V-0

DEMKO16ATEX1729U

Rated connection

0.5...2.5
0.5...2.5 / 0.5...2.5
10 / 0.6 x 3.5 mm

Type	Qty.	Order No.
ZDK 2.5DU-PE	50	1689970000

Type	Qty.	Order No.
ZQV 2.5/2	24 A 60	1608860000
ZQV 2.5/10	24 A 20	1608940000
ZAP/TW ZDK2.5	20	1674730000
ZAP/TW ZDK2.5 BL	20	1748800000
ZEW 35	20	9540000000
ZTA ZDK 2.5	6 A 5	1052660000
ZTA ZDK 2.5/ZA	6 A 5	1052680000
SDIS SLIM 0.6X3.5X100	1	2749610000
ZRH 1.5H/1	1000	1678810000
ZRH 1.5H/2	1000	1678800000
DEK 5/5 MC NE WS	1000	1609801044
WS 12/5 MC NE WS	720	1609860000
DEK 5/5 MM WS	800	2007110000
WS 8/5 MM WS	800	2007150000

ZDK 2.5 N-DU

2.5 mm²

Neutral conductor - phase

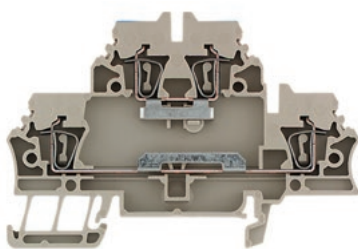

5.1 x 79.5 x 53
23 / 2.5
0.05...2.5

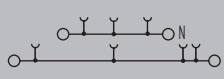

Ex eb II
C Gb II 2 G D

IEC 60947-7-1

IEC	UL	CSA	EN 60079-7
500	300		352
20	15		19
2.5	AWG 26...14		2.5 mm ²

6 kV / 3
A2 / V-0

DEMKO16ATEX1729U

Rated connection

0.5...2.5
0.5...2.5 / 0.5...2.5
10 / 0.6 x 3.5 mm

Type	Qty.	Order No.
ZDK 2.5N-DU	50	1689960000

Type	Qty.	Order No.
ZQV 2.5/2	24 A 60	1608860000
ZQV 2.5/10	24 A 20	1608940000
ZAP/TW ZDK2.5	20	1674730000
ZAP/TW ZDK2.5 BL	20	1748800000
ZEW 35	20	9540000000
ZTA ZDK 2.5	6 A 5	1052660000
ZTA ZDK 2.5/ZA	6 A 5	1052680000
SDIS SLIM 0.6X3.5X100	1	2749610000
ZRH 1.5H/1	1000	1678810000
ZRH 1.5H/2	1000	1678800000
DEK 5/5 MC NE WS	1000	1609801044
WS 12/5 MC NE WS	720	1609860000
DEK 5/5 MM WS	800	2007110000
WS 8/5 MM WS	800	2007150000

ZQV 2.5/1.5 (1720700000) connects the upper and lower layer.

ZDK 2.5 N-PE

2.5 mm²

Neutral & PE conductor

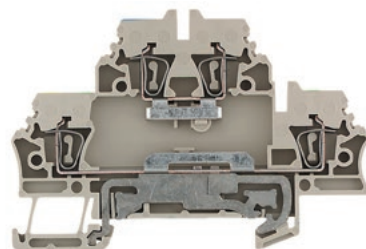

5.1 x 79.5 x 53
24 / 2.5
0.05...2.5

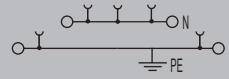

Ex eb II
C Gb II 2 G D

IEC 60947-7-1 (-7-2)

IEC	UL	CSA	EN 60079-7
500	300		352
20	15		20
2.5	AWG 26...14		2.5 mm ²

6 kV / 3
A2 / V-0

DEMKO16ATEX1729U

Rated connection

0.5...2.5
0.5...2.5 / 0.5...2.5
10 / 0.6 x 3.5 mm

Type	Qty.	Order No.
ZDK 2.5N-PE	50	1689980000

Type	Qty.	Order No.
ZQV 2.5/2	24 A 60	1608860000
ZQV 2.5/10	24 A 20	1608940000
ZAP/TW ZDK2.5	20	1674730000
ZAP/TW ZDK2.5 BL	20	1748800000
ZEW 35	20	9540000000
ZTA ZDK 2.5	6 A 5	1052660000
ZTA ZDK 2.5/ZA	6 A 5	1052680000
SDIS SLIM 0.6X3.5X100	1	2749610000
ZRH 1.5H/1	1000	1678810000
ZRH 1.5H/2	1000	1678800000
DEK 5/5 MC NE WS	1000	1609801044
WS 12/5 MC NE WS	720	1609860000
DEK 5/5 MM WS	800	2007110000
WS 8/5 MM WS	800	2007150000

Spring connection with tension clamp technology (Z-Series)

Feed-through terminal blocks

ZDLD 2.5-2 N

2.5 mm²

Three levels



5.1 x 110.5 x 69
20 / 2.5
0.08...2.5

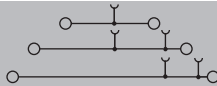

ZDLD 2.5-2 VN

2.5 mm²

Vertically cross-connected multi-level terminal

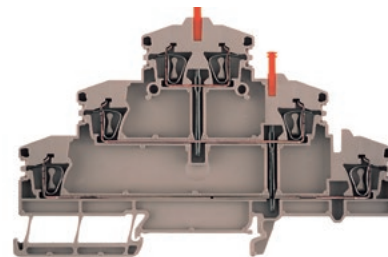

5.1 x 110.5 x 69
20 / 2.5
0.08...2.5

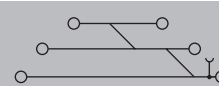

Width/Height/Depth mm
max. current / max. cond. cross-section A/mm²
Max. clamping range mm²

Technical data

Rated data	
Rated voltage	V
Rated current	A
for wire cross-section	mm ²
Rated impulse withstand voltage / Pollution severity	
Gauge to IEC 60947-1 / UL 94 flammability rating	
Approvals	
Clamped conductors (H05V/H07V)	
Solid / Stranded	mm ²
Flexible / Flexible with ferrule	mm ²
Stripping length / Blade size	mm/-
Note	

Ordering data

Version	
	dark beige
	Blue
Note	

Accessories

Vertical jumpers	1-pole
Plug-in cross-connection	2-pole 10-pole
End plate / Partition plate	dark beige Blue
End bracket	dark beige
Test adapter	With spigot
Screwdriver	Standard With "swifty set" cutting device
Reducing sleeves	for conductors < 1.0 mm ² / AWG 18 for conductors < 0.5 mm ² / AWG 20
Marking tags	

IEC 60947-7-1

IEC	UL	CSA	EN 60079-7
500	300	300	
20	15	15	
2.5	AWG 26...12	AWG 26...12	
6 kV / 3			
A2 / V-0			

CE ENEC

Rated connection	
0.5...2.5	
0.5...2.5 / 0.5...1.5	
10 / 0.6 x 3.5 mm	

Type	Qty.	Order No.
ZDLD 2.5-2N	50	1782300000
ZDLD 2.5-2N BL	50	1782310000

Type	Qty.	Order No.
ZVQ 2.5/1.5	24 A 50	1720700000
ZQV 2.5/2	24 A 60	1608860000
ZQV 2.5/10	24 A 20	1608940000
ZAP/TW ZDLD2.5-2N	20	1782340000
ZAP/TW ZDLD2.5-2N BL	20	1782350000
ZEW 35	20	9540000000
ZTA 4	11 A 25	1688110000
SDIS SLIM 0.6X3.5X100	1	2749610000
SWIFTY SET	1	9006060000
ZRH 1.5H/2	1000	1678800000
ZRH 1.5H/1	1000	1678810000
DEK 5/5 MC NE WS	1000	1609801044
WS 12/5 MC NE WS	720	1609860000
DEK 5/5 MM WS	800	2007110000
WS 8/5 MM WS	800	2007150000

IEC 60947-7-1

IEC	UL	CSA	EN 60079-7
400	300	300	
20	15	15	
2.5	AWG 26...12	AWG 26...12	
6 kV / 3			
A2 / V-0			

CE ENEC

Rated connection	
0.5...2.5	
0.5...2.5 / 0.5...1.5	
10 / 0.6 x 3.5 mm	

Type	Qty.	Order No.
ZDLD 2.5-2VN	25	1782320000
ZDLD 2.5-2VN BL	25	1782330000

Type	Qty.	Order No.
ZQV 2.5/2	24 A 60	1608860000
ZQV 2.5/10	24 A 20	1608940000
ZAP/TW ZDLD2.5-2N	20	1782340000
ZAP/TW ZDLD2.5-2N BL	20	1782350000
ZEW 35	20	9540000000
ZTA 4	11 A 25	1688110000
SDIS SLIM 0.6X3.5X100	1	2749610000
SWIFTY SET	1	9006060000
ZRH 1.5H/2	1000	1678800000
ZRH 1.5H/1	1000	1678810000
DEK 5/5 MC NE WS	1000	1609801044
WS 12/5 MC NE WS	720	1609860000
DEK 5/5 MM WS	800	2007110000
WS 8/5 MM WS	800	2007150000

For detailed information on other accessories and application in the online catalogue

ZVQ 2.5/1.5 (1720700000) connects the upper and lower layer.

ZDLD 2.5-2 N PE/L/L

2.5 mm²

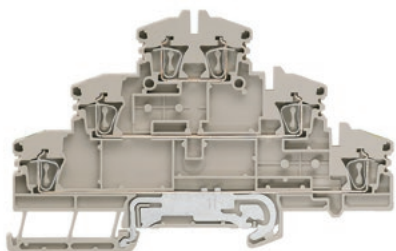

5.1 x 110.5 x 69
20 / 2.5
0.08...2.5

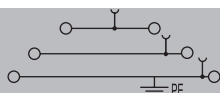

IEC	UL	CSA	EN 60079-7
500	150	150	
20	15	15	
2.5	AWG 26...12	AWG 26...12	
6 kV / 3			
A2 / V-0			

CE

Rated connection

0.5...2.5
0.5...2.5 / 0.5...1.5
10 / 0.6 x 3.5 mm

Type	Qty.	Order No.
ZDLD 2.5-2N/PE/L/L	50	1131750000

ZDLD 2.5-2 N PE/L/N

2.5 mm²

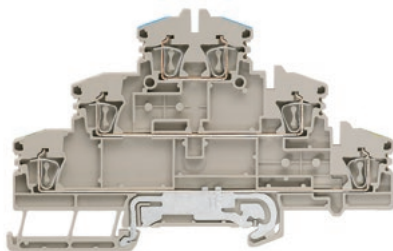

5.1 x 110.5 x 69
20 / 2.5
0.08...2.5

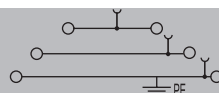

IEC	UL	CSA	EN 60079-7
500	150	150	
20	15	15	
2.5	AWG 26...12	AWG 26...12	
6 kV / 3			
A2 / V-0			

CE

Rated connection

0.5...2.5
0.5...2.5 / 0.5...1.5
10 / 0.6 x 3.5 mm

Type	Qty.	Order No.
ZDLD 2.5-2N/PE/L/N	50	1131760000

ZDLD 2.5-2 N PE

2.5 mm²

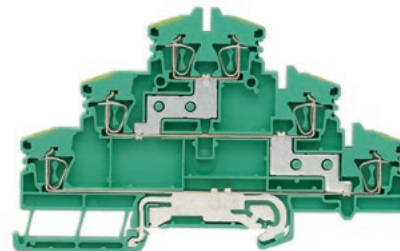

5.1 x 110.5 x 69
/ 2.5
0.08...2.5

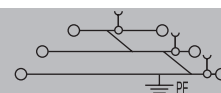

IEC	UL	CSA	EN 60079-7
500			
2.5	AWG 26...12	AWG 26...12	
/ 3			
/ V-0			

CE

Rated connection

0.5...2.5 / 0.5...2.5
0.5...2.5 / 0.5...2.5
10 /

Type	Qty.	Order No.
ZDLD 2.5-2N PE	50	1131740000

Type	Qty.	Order No.
ZVQ 2.5/1.5	24 A 50	1720700000
ZQV 2.5/2	24 A 60	1608860000
ZQV 2.5/10	24 A 20	1608940000
ZAP/TW ZDLD2.5-2N	20	1782340000
ZAP/TW ZDLD2.5-2N BL	20	1782350000
ZEW 35	20	9540000000
ZTA 4	11 A 25	1688110000
SDIS SLIM 0.6X3.5X100	1	2749610000
SWIFTY SET	1	9006060000
ZRH 1.5H/2	1000	1678800000
ZRH 1.5H/1	1000	1678810000
DEK 5/5 MC NE WS	1000	1609801044
WS 12/5 MC NE WS	720	1609860000
DEK 5/5 MM WS	800	2007110000
WS 8/5 MM WS	800	2007150000

Type	Qty.	Order No.
ZVQ 2.5/1.5	24 A 50	1720700000
ZQV 2.5/2	24 A 60	1608860000
ZQV 2.5/10	24 A 20	1608940000
ZAP/TW ZDLD2.5-2N	20	1782340000
ZAP/TW ZDLD2.5-2N BL	20	1782350000
ZEW 35	20	9540000000
ZTA 4	11 A 25	1688110000
SDIS SLIM 0.6X3.5X100	1	2749610000
SWIFTY SET	1	9006060000
ZRH 1.5H/2	1000	1678800000
ZRH 1.5H/1	1000	1678810000
DEK 5/5 MC NE WS	1000	1609801044
WS 12/5 MC NE WS	720	1609860000
DEK 5/5 MM WS	800	2007110000
WS 8/5 MM WS	800	2007150000

Type	Qty.	Order No.
ZVQ 2.5/1.5	24 A 50	1720700000
ZQV 2.5/2	24 A 60	1608860000
ZQV 2.5/10	24 A 20	1608940000
ZAP/TW ZDLD2.5-2N	20	1782340000
ZAP/TW ZDLD2.5-2N BL	20	1782350000
ZEW 35	20	9540000000
ZTA 4	11 A 25	1688110000
SDIS SLIM 0.6X3.5X100	1	2749610000
SWIFTY SET	1	9006060000
ZRH 1.5H/2	1000	1678800000
ZRH 1.5H/1	1000	1678810000
DEK 5/5 MC NE WS	1000	1609801044
WS 12/5 MC NE WS	720	1609860000
DEK 5/5 MM WS	800	2007110000
WS 8/5 MM WS	800	2007150000



Spring connection with tension clamp technology (Z-Series)

Feed-through terminal blocks

ZVLD 2.5

2.5 mm²

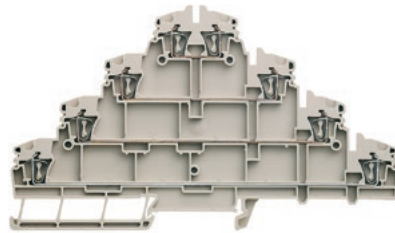

Width/Height/Depth	mm
max. current / max. cond. cross-section	A/mm ²
Max. clamping range	mm ²

5.1 x 148 x 85
20 / 2.5
0.14...2.5

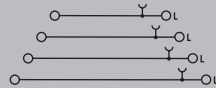

Technical data

Rated data	
Rated voltage	V
Rated current	A
for wire cross-section	mm ²
Rated impulse withstand voltage / Pollution severity	
Gauge to IEC 60947-1 / UL 94 flammability rating	
Approvals	
Clamped conductors (H05V/H07V)	
Solid / Stranded	mm ²
Flexible / Flexible with ferrule	mm ²
Stripping length / Blade size	mm/-

IEC 60947-7-1

IEC	UL	CSA	EN 60079-7
250			
20			
2.5			
		6 kV / 3	
		A2 / V-0	
EH			
Rated connection			
0.5...2.5 / 0.5...2.5			
0.5...2.5 / 0.5...2.5			
10 / 0.6 x 3.5 mm			

Note

Ordering data

Version	
	dark beige
Note	

Type	Qty.	Order No.
ZVLD 2.5	50	1208920000

Accessories

Vertical jumpers	1-pole
Plug-in cross-connection	2-pole 10-pole
End plate / Partition plate	dark beige
End bracket	dark beige
Marking tags	

Type	Qty.	Order No.
ZVQ 2.5/1.5	24 A 50	1720700000
ZQV 2.5/2	24 A 60	1608860000
ZQV 2.5/10	24 A 20	1608940000
ZAP ZVLD 2.5	10	1210410000
ZEW 35/2	20	8630740000
DEK 5/5 MC NE WS	1000	1609801044
DEK 5/5 MM WS	800	2007110000
WS 8/5 MM WS	800	2007150000

For detailed information on other accessories and application in the online catalogue

ZMAK 2.5

2.5 mm²

Motor-supply terminal

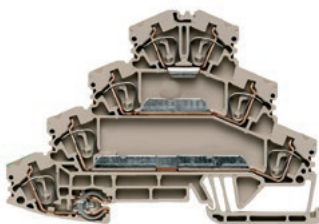

5.1 x 102 x 69.5
31 / 4
0.13...4

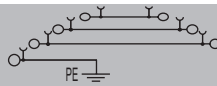

Width/Height/Depth mm
max. current / max. cond. cross-section A/mm²
Max. clamping range mm²

Technical data

Rated data	
Rated voltage	V
Rated current	A
for wire cross-section	mm ²
Rated impulse withstand voltage / Pollution severity	
Gauge to IEC 60947-1 / UL 94 flammability rating	
Approvals	
Clamped conductors (H05V/H07V)	
Solid / Stranded	mm ²
Flexible / Flexible with ferrule	mm ²
Stripping length / Blade size	mm/-

Note

Ordering data

Version	
	dark beige
Note	

Accessories

End plate / Partition plate	
	dark beige
End bracket	dark beige
Screwdriver	Standard
Reducing sleeves	for conductors < 0.5 mm ² / AWG 20 for conductors < 1.0 mm ² / AWG 18
Test adapter	Standard
Marking tags	

For detailed information on other accessories and application in the online catalogue

ZMAK 2.5 690 V

2.5 mm²

Motor-supply terminal



6.1 x 102 x 69.5
31 / 4
0.13...4

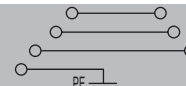

IEC 60947-7-1 (-7-2)

IEC	UL	CSA	EN 60079-7
690	300		
24	25		
2.5	AWG 26...12	AWG 26...12	
6 kV / 3			
A3 / V-0			

CE ENEC

Rated connection	
0.5...4	
0.5...4 / 0.5...2.5	
10 / 0.6 x 3.5 mm	

Note

Type	Qty.	Order No.
ZMAK 2.5 690V	25	1027550000

The ZMAK 2.5 690 V with pre-assembled end plate and a width of 6.1 mm.

Type	Qty.	Order No.
ZMAK 2.5	25	1768000000

Type	Qty.	Order No.
ZAP ZMAK2.5	10	1768010000
ZEW 35	20	9540000000
SDIS SLIM 0.6X3.5X100	1	2749610000
ZRH 1.5H/1	1000	1678810000
ZRH 1.5H/2	1000	1678800000
ZTA 1	9 A	1609040000
DEK 5/5 MC NE WS	1000	1609801044
WS 12/5 MC NE WS	720	1609860000
DEK 5/5 MM WS	800	2007110000
WS 8/5 MM WS	800	2007150000

Type	Qty.	Order No.
ZAP ZMAK2.5	10	1768010000
ZEW 35	20	9540000000
SDIS SLIM 0.6X3.5X100	1	2749610000
ZRH 1.5H/1	1000	1678810000
ZRH 1.5H/2	1000	1678800000
DEK 5/5 MC NE WS	1000	1609801044
WS 12/5 MC NE WS	720	1609860000



Spring connection with tension clamp technology (Z-Series)
Feed-through terminal blocks

ZDK 2.5-2

2.5 mm²

Double-level terminal

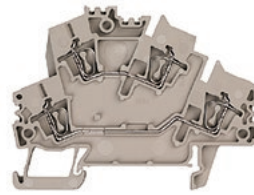

5.1 x 72.5 x 54.5
24 / 4
0.05...4

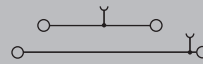

Ex eb II
 C Gb II 2 G D

IEC 60947-7-1

IEC	UL	CSA	EN 60079-7
800	600	600	550
24	20	25	21
2.5	AWG 30...12	AWG 30...12	4 mm ²

8 kV / 3

A2 / V-0

DEMKO16ATEX1808U

Rated connection

0.5...4

0.5...2.5 / 0.5...1.5

10 / 0.6 x 3.5 mm

Width/Height/Depth mm
 max. current / max. cond. cross-section A/mm²
 Max. clamping range mm²

Technical data

Rated data	
Rated voltage	V
Rated current	A
for wire cross-section	mm ²
Rated impulse withstand voltage / Pollution severity	
Gauge to IEC 60947-1 / UL 94 flammability rating	
Approvals	
Clamped conductors (H05V/H07V)	
Solid / Stranded	mm ²
Flexible / Flexible with ferrule	mm ²
Stripping length / Blade size	mm/-
Note	

Ordering data

Version	
	dark beige
	Blue
Note	

Accessories

Plug-in cross-connection	
	2-pole
	10-pole
End plate / Partition plate	
	dark beige
	Blue
End bracket	
	dark beige
Test adapter	
	With spigot
Screwdriver	
	Standard
Reducing sleeves	
	for conductors < 0.5 mm ² / AWG 20
	for conductors < 1.0 mm ² / AWG 18
Cover	
	With lightning flash symbol
Marking tags	

For detailed information on other accessories and application in the online catalogue

ZDK 2.5-2V

2.5 mm²

Vertical cross-connected double-level terminal

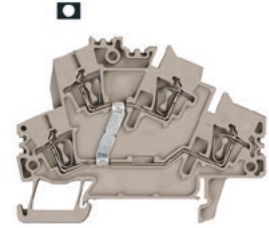

5.1 x 72.5 x 54.5
24 / 4
0.05...4

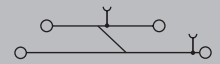

Ex eb II
 C Gb II 2 G D

IEC 60947-7-1

IEC	UL	CSA	EN 60079-7
800	600	300	550
24	20	25	21
2.5	AWG 30...12	AWG 30...12	4 mm ²

8 kV / 3

A2 / V-0

DEMKO16ATEX1808U

Rated connection

0.5...4

0.5...2.5 / 0.5...1.5

10 / 0.6 x 3.5 mm

Type	Qty.	Order No.
ZDK 2.5-2	50	1790990000
ZDK 2.5-2 BL	50	1791000000

Type	Qty.	Order No.
ZDK 2.5-2V	50	1791030000
ZDK 2.5-2V BL	50	1791040000

Type	Qty.	Order No.
ZQV 2.5/2	24 A 60	1608860000
ZQV 2.5/10	24 A 20	1608940000
ZAP/TW ZDK2.5-2	20	1791050000
ZAP/TW ZDK2.5-2 BL	20	1791060000
ZEW 35	20	9540000000
ZTA 4	11 A 25	1688110000
SDIS SLIM 0.6X3.5X100	1	2749610000
ZRH 1.5H/1	1000	1678810000
ZRH 1.5H/2	1000	1678800000
ZAD 1/4-2 GE	20	1764560000
DEK 5/5 MC NE WS	1000	1609801044
WS 10/5 MC NE WS	720	1635000000
DEK 5/5 MM WS	800	2007110000

Type	Qty.	Order No.
ZQV 2.5/2	24 A 60	1608860000
ZQV 2.5/10	24 A 20	1608940000
ZAP/TW ZDK2.5-2	20	1791050000
ZAP/TW ZDK2.5-2 BL	20	1791060000
ZEW 35	20	9540000000
ZTA 4	11 A 25	1688110000
SDIS SLIM 0.6X3.5X100	1	2749610000
ZRH 1.5H/1	1000	1678810000
ZRH 1.5H/2	1000	1678800000
ZAD 1/4-2 GE	20	1764560000
DEK 5/5 MC NE WS	1000	1609801044
WS 10/5 MC NE WS	720	1635000000
DEK 5/5 MM WS	800	2007110000

ZDK 2.5-2/4

2.5 mm²

Double-level terminal

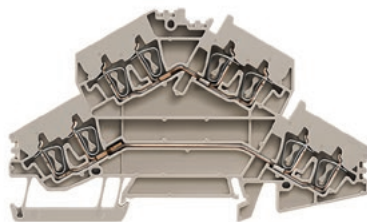

Width/Height/Depth	mm
max. current / max. cond. cross-section	A/mm ²
Max. clamping range	mm ²

5.1 x 104 x 62	
26 / 4	
0.05...4	

Technical data

Rated data	
Rated voltage	V
Rated current	A
for wire cross-section	mm ²
Rated impulse withstand voltage / Pollution severity	
Gauge to IEC 60947-1 / UL 94 flammability rating	
Approvals	
Clamped conductors (H05V/H07V)	
Solid / Stranded	mm ²
Flexible / Flexible with ferrule	mm ²
Stripping length / Blade size	mm/-

Ex eb II
C Gb II 2 G D

IEC	UL	CSA	EN 60079-7
800	600	600	550
22	20	20	19
2.5	AWG 30...12	AWG 30...12	4 mm ²
8 kV / 3			
A2 / V-0			
		DEMKO16ATEX1808U	
Rated connection			
0.5...4 / 1.5...2.5			
0.5...2.5 / 0.5...2.5			
10 / 0.6 x 3.5 mm			

Note

Ordering data

Version	dark beige
Note	

Type	Qty.	Order No.
ZDK 2.5-2/4AN	50	1394040000

Accessories

Plug-in cross-connection	2-pole 10-pole
End plate / Partition plate	dark beige
End bracket	dark beige
Test adapter	With spigot
Screwdriver	Standard
Reducing sleeves	for conductors < 0.5 mm ² / AWG 20 for conductors < 1.0 mm ² / AWG 18
Cover	With lightning flash symbol
Marking tags	

Type	Qty.	Order No.
ZQV 2.5/2	24 A 60	1608860000
ZQV 2.5/10	24 A 20	1608940000
ZAP/TW ZDK2.5-2/4AN	20	1394050000
ZEW 35	20	9540000000
ZTA ZT2.5/ZA	17.5 A 25	1847600000
SDS 0.6X3.5X100	1	2749340000
ZRH 1.5H/1	1000	1678810000
ZRH 1.5H/2	1000	1678800000
ZAD 1/4-2 GE	20	1764560000
SNAPMARK I	50	1805880000
DEK 5/5 MC NE WS	1000	1609801044
WS 10/5 MC NE WS	720	1635000000
DEK 5/5 MM WS	800	2007110000

For detailed information on other accessories and application in the online catalogue



Spring connection with tension clamp technology (Z-Series)

Feed-through terminal blocks

ZDKPE 2.5-2

2.5 mm²

Double-tier terminal with one-sided PE connection

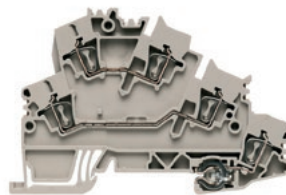

Width/Height/Depth	mm
max. current / max. cond. cross-section	A/mm ²
Max. clamping range	mm ²

5.1 x 89.5 x 59.5	
24 / 4	
0.05...4	

Technical data

Rated data	
Rated voltage	V
Rated current	A
for wire cross-section	mm ²
Rated impulse withstand voltage / Pollution severity	
Gauge to IEC 60947-1 / UL 94 flammability rating	
Approvals	
Clamped conductors (H05V/H07V)	
Solid / Stranded	mm ²
Flexible / Flexible with ferrule	mm ²
Stripping length / Blade size	mm/-
Note	

Ordering data

Version	
	dark beige
Note	

Accessories

Plug-in cross-connection	
	2-pole
	10-pole
End plate / Partition plate	dark beige
End bracket	dark beige
Test adapter	With spigot
Screwdriver	Standard With "swifty set" cutting device
Reducing sleeves	for conductors < 0.5 mm ² / AWG 20 for conductors < 1.0 mm ² / AWG 18
Cover	With lightning flash symbol
Marking tags	

For detailed information on other accessories and application in the online catalogue

ZDKPE 2.5-2/N/L/PE

2.5 mm²

Double-tier terminal with one-sided PE connection

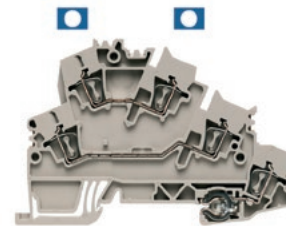

5.1 x 89.5 x 59.5	
24 / 4	
0.05...4	

IEC 60947-7-1 (-7-2)			
IEC	UL	CSA	EN 60079-7
800	600	300	
24	20	25	
2.5	AWG 26...12	AWG 30...12	
8 kV / 3			
A2 / V-0			
Rated connection			
0.5...4			
0.5...2.5 / 0.5...1.5			
10 / 0.6 x 3.5 mm			
Note			

Type	Qty.	Order No.
ZDKPE 2.5-2/N/L/PE	50	1895700000
Note		

Type	Qty.	Order No.
ZQV 2.5/2	24 A 60	1608860000
ZQV 2.5/10	24 A 20	1608940000
ZAP/TW ZDKPE2.5-2	25	1805960000
ZEW 35	20	9540000000
ZTA 4	11 A 25	1688110000
SDIS SLIM 0.6X3.5X100	1	2749610000
SWIFTY SET	1	9006060000
ZRH 1.5H/1	1000	1678810000
ZRH 1.5H/2	1000	1678800000
ZAD 1/4-2 GE	20	1764560000
DEK 5/5 MC NE WS	1000	1609801044
WS 10/5 MC NE WS	720	1635000000
DEK 5/5 MM WS	800	2007110000

For detailed information on other accessories and application in the online catalogue

ZDK 4-2

4 mm²

Double-level terminal



6.1 x 77.6 x 60
32 / 6
0.13...6



Width/Height/Depth mm
max. current / max. cond. cross-section A/mm²
Max. clamping range mm²

Technical data

Rated data	
Rated voltage	V
Rated current	A
for wire cross-section	mm ²
Rated impulse withstand voltage / Pollution severity	
Gauge to IEC 60947-1 / UL 94 flammability rating	
Approvals	
Clamped conductors (H05V/H07V)	
Solid / Stranded	mm ²
Flexible / Flexible with ferrule	mm ²
Stripping length / Blade size	mm/-
Note	

Ordering data

Version	
	dark beige
	Blue
Note	

Accessories

Plug-in cross-connection	
	2-pole
	10-pole
End plate / Partition plate	
	dark beige
End bracket	
	dark beige
Test adapter	
	With spigot
Screwdriver	
	Standard
Cover	
	With lightning flash symbol
Marking tags	

For detailed information on other accessories and application in the online catalogue

ZDK 4-2 V

4 mm²

Vertical cross-connected double-level terminal

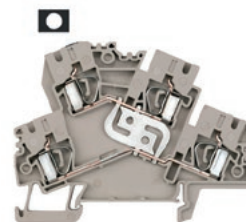

6.1 x 77.6 x 60
32 / 6
0.13...6

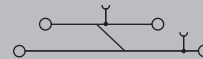

IEC 60947-7-1

IEC	UL	CSA	EN 60079-7
800	600	600	
32	25	30	
4	AWG 26...10	AWG 26...10	
8 kV / 3			
A3 / V-0			

CE

Rated connection	
0.5...6	
0.5...4 / 0.5...4	
10 / 0.6 x 3.5 mm	

Note

Type	Qty.	Order No.
ZDK 4-2 V	50	8671080000

Type	Qty.	Order No.
ZQV 4/2 GE	32 A 60	1608950000
ZQV 4/10 GE	32 A 20	1609030000
ZAP/TW ZDK4-2	50	8670760000
ZEW 35	20	9540000000
ZTA 6/ZA	17.5 A 25	1780660000
SDIS SLIM 0.6X3.5X100	1	2749610000
ZAD 1/4	20	1609110000
DEK 5/6 MC NE WS	1000	1609820000
DEK 5/6 MM WS	600	2007120000
WS 8/6 MM WS	600	2007160000

For detailed information on other accessories and application in the online catalogue



Spring connection with tension clamp technology (Z-Series)

Feed-through terminal blocks

ZDK 4-2 DU/PE

4 mm²

Phase - PE conductor



Width/Height/Depth	mm
max. current / max. cond. cross-section	A/mm ²
Max. clamping range	mm ²

6.1 x 77.6 x 60
32 / 6
0.13...6

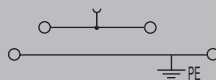

Technical data

Rated data	
Rated voltage	V
Rated current	A
for wire cross-section	mm ²
Rated impulse withstand voltage / Pollution severity	
Gauge to IEC 60947-1 / UL 94 flammability rating	
Approvals	
Clamped conductors (H05V/H07V)	
Solid / Stranded	mm ²
Flexible / Flexible with ferrule	mm ²
Stripping length / Blade size	mm/-

IEC 60947-7-1 (-7-2)

IEC	UL	CSA	EN 60079-7
800	600	600	
32	25	30	
4	AWG 26...10	AWG 26...10	
8 kV / 3			
A3 / V-0			

CE G B V

Rated connection	
0.5...6	
0.5...4 / 0.5...4	
10 / 0.6 x 3.5 mm	

Note

Ordering data

Version	
	dark beige
	Blue

Note

Type	Qty.	Order No.
ZDK 4-2/DU-PE	50	8671120000

Accessories

Plug-in cross-connection	
	2-pole
	10-pole
End plate / Partition plate	
	dark beige
End bracket	dark beige
Test adapter	With spigot
Screwdriver	Standard
Cover	With lightning flash symbol
Marking tags	

Type	Qty.	Order No.
ZQV 4/2 GE	32 A 60	1608950000
ZQV 4/10 GE	32 A 20	1609030000
ZAP/TW ZDK4-2	50	8670760000
ZEW 35	20	9540000000
ZTA 6/ZA	17.5 A 25	1780660000
SDIS SLIM 0.6X3.5X100	1	2749610000
ZAD 1/4	20	1609110000
DEK 5/6 MC NE WS	1000	1609820000
DEK 5/6 MM WS	600	2007120000
WS 8/6 MM WS	600	2007160000

For detailed information on other accessories and application in the online catalogue

ZDK 4-2/2AN

4 mm²

Double-level terminal





Width/Height/Depth	mm
max. current / max. cond. cross-section	-/mm ²
Max. clamping range	mm ²

8.1 x 78 x 60
/ 6
0.13...6



Technical data

Rated data	
Rated voltage	V
Rated current	A
for wire cross-section	mm ²
Rated impulse withstand voltage / Pollution severity	
Gauge to IEC 60947-1 / UL 94 flammability rating	
Approvals	
Clamped conductors (H05V/H07V)	
Solid / Stranded	mm ²
Flexible / Flexible with ferrule	mm ²
Stripping length / Blade size	mm/-

IEC	UL	CSA	EN 60079-7
800			
32			
4	AWG 26...10		
		/ 3	
		A3 / V-0	
  			
Rated connection			
0.5...6			
0.5...4 / 0.5...4			
10 / 0.6 x 3.5 mm			

Note

Ordering data

Version	
	dark beige
Note	

Type	Qty.	Order No.
ZDK 4-2/2AN	50	1119700000

Accessories

Cover	With lightning flash symbol
End bracket	dark beige
Test adapter	With spigot
Screwdriver	Standard
Marking tags	

Type	Qty.	Order No.
ZAD 1/4	20	1609110000
ZEW 35	20	9540000000
ZTA 6/ZA	17.5 A 25	1780660000
SDIS SLIM 0.6X3.5X100	1	2749610000
DEK 5/6 MC NE WS	1000	1609820000

For detailed information on other accessories and application in the online catalogue



Spring connection with tension clamp technology (Z-Series)
Feed-through terminal blocks

Universal range

A

ZDK 2.5/3AN

2.5 mm²

Double-level terminal

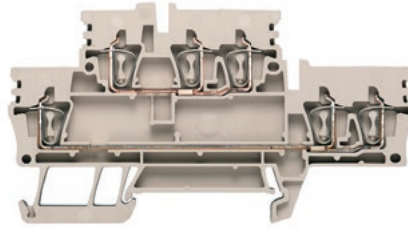

ZDK 2.5/3AN V

2.5 mm²

Vertical cross-connected double-level terminal

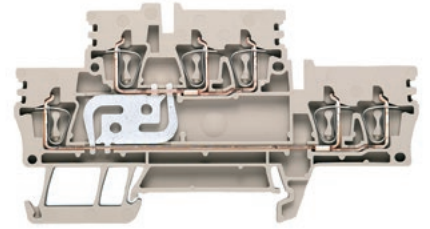

Width/Height/Depth	mm
max. current / max. cond. cross-section	A/mm ²
Max. clamping range	mm ²

5.1 x 93 x 50.5	
24 / 4	
0.05...4	

5.1 x 93 x 50.5	
24 / 4	
0.05...4	

Technical data

Rated data	
Rated voltage	V
Rated current	A
for wire cross-section	mm ²
Rated impulse withstand voltage / Pollution severity	
Gauge to IEC 60947-1 / UL 94 flammability rating	
Approvals	
Clamped conductors (H05V/H07V)	
Solid / Stranded	mm ²
Flexible / Flexible with ferrule	mm ²
Stripping length / Blade size	mm/-
Note	

IEC 60947-7-1 Ex eb II C Gb II 2 G D

IEC	UL	CSA	EN 60079-7
800	300	300	440
24	20	24	21
2.5	AWG 30...12	AWG 30...12	2.5 mm ²
8 kV / 3			
A2 / V-0			
DEMKO16ATEX1729U			
Rated connection			
0.5...4 / 0.5...2.5			
0.5...2.5 / 0.5...2.5			
10 / 0.6 x 3.5 mm			

IEC 60947-7-1 Ex eb II C Gb II 2 G D

IEC	UL	CSA	EN 60079-7
800	300	300	440
24	20	24	20
2.5	AWG 30...12	AWG 30...12	2.5 mm ²
8 kV / 3			
A2 / V-0			
DEMKO16ATEX1729U			
Rated connection			
0.5...4 / 0.5...2.5			
0.5...2.5 / 0.5...2.5			
10 / 0.6 x 3.5 mm			

Ordering data

Version	
	dark beige
	Blue
Note	

Type	Qty.	Order No.
ZDK 2.5/3AN	50	1924510000
ZDK 2.5/3AN BL	50	1924500000

Type	Qty.	Order No.
ZDK 2.5/3AN V	50	1924490000
ZDK 2.5/3AN V BL	50	1924480000

Accessories

Plug-in cross-connection	
	2-pole
	10-pole
End plate / Partition plate	
	dark beige
End bracket	
	dark beige
Test adapter	
	Standard
	With spigot
Screwdriver	
	Standard
Reducing sleeves	
	for conductors < 0.5 mm ² / AWG 20
	for conductors < 1.0 mm ² / AWG 18
Cover	
	With lightning flash symbol
Marking tags	

Type	Qty.	Order No.
ZQV 2.5/2	24 A 60	1608860000
ZQV 2.5/10	24 A 20	1608940000
ZAP/TW ZDK 2.5/3AN	20	1924910000
ZEW 35	20	9540000000
ZTA ZT2.5	17.5 A 25	1827080000
ZTA ZT2.5/ZA	17.5 A 25	1847600000
SDIS SLIM 0.6X3.5X100	1	2749610000
ZRH 1.5H/1	1000	1678810000
ZRH 1.5H/2	1000	1678800000
ZAD 9/4	20	1934160000
SNAPMARK I	50	1805880000
DEK 5/5 MC NE WS	1000	1609801044
WS 10/5 MC NE WS	720	1635000000
DEK 5/5 MM WS	800	2007110000

Type	Qty.	Order No.
ZQV 2.5/2	24 A 60	1608860000
ZQV 2.5/10	24 A 20	1608940000
ZAP/TW ZDK 2.5/3AN	20	1924910000
ZEW 35	20	9540000000
ZTA ZT2.5	17.5 A 25	1827080000
ZTA ZT2.5/ZA	17.5 A 25	1847600000
SDIS SLIM 0.6X3.5X100	1	2749610000
ZRH 1.5H/1	1000	1678810000
ZRH 1.5H/2	1000	1678800000
ZAD 9/4	20	1934160000
SNAPMARK I	50	1805880000
DEK 5/5 MC NE WS	1000	1609801044
WS 10/5 MC NE WS	720	1635000000
DEK 5/5 MM WS	800	2007110000

For detailed information on other accessories and application in the online catalogue

ZDK 2.5/3AN DU-PE

2.5 mm²

Double-level terminal (DU-PE)

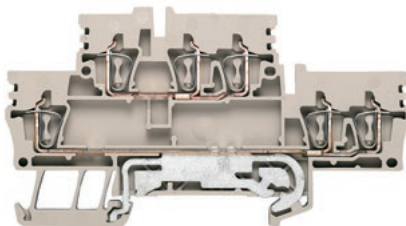

Width/Height/Depth	mm
max. current / max. cond. cross-section	A/mm ²
Max. clamping range	mm ²

5.1 x 93 x 50.5
31 / 4
0.05...4

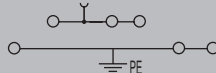

Technical data

Rated data	
Rated voltage	V
Rated current	A
for wire cross-section	mm ²
Rated impulse withstand voltage / Pollution severity	
Gauge to IEC 60947-1 / UL 94 flammability rating	
Approvals	
Clamped conductors (H05V/H07V)	
Solid / Stranded	mm ²
Flexible / Flexible with ferrule	mm ²
Stripping length / Blade size	mm/-

IEC 60947-7-1 (-7-2) Ex eb II C Gb II 2 G D

IEC	UL	CSA	EN 60079-7
800	300	300	440
24	20	24	21
2.5	AWG 30...12	AWG 30...12	2.5 mm ²

8 kV / 3
A2 / V-0

DEMKD16ATEX1729U

Rated connection	
0.5...4 / 0.5...2.5	
0.5...2.5 / 0.5...2.5	
10 / 0.6 x 3.5 mm	

Note

Ordering data

Version	Green/yellow
Note	

Type	Qty.	Order No.
ZDK 2.5/3AN DU-PE	50	1924460000

Accessories

Plug-in cross-connection	
	2-pole
	10-pole
End plate / Partition plate	
	dark beige
End bracket	
	dark beige
Test adapter	
	Standard
	With spigot
Screwdriver	
	Standard
Reducing sleeves	
	for conductors < 0.5 mm ² / AWG 20
	for conductors < 1.0 mm ² / AWG 18
Cover	
	With lightning flash symbol
Marking tags	

Type	Qty.	Order No.
ZQV 2.5/2	24 A 60	1608860000
ZQV 2.5/10	24 A 20	1608940000
ZAP/TW ZDK 2.5/3AN	20	1924910000
ZEW 35	20	9540000000
ZTA ZT2.5	17.5 A 25	1827080000
ZTA ZT2.5/ZA	17.5 A 25	1847600000
SDIS SLIM 0.6X3.5X100	1	2749610000
ZRH 1.5H/1	1000	1678810000
ZRH 1.5H/2	1000	1678800000
ZAD 9/4	20	1934160000
SNAPMARK I	50	1805880000
DEK 5/5 MC NE WS	1000	1609801044
WS 10/5 MC NE WS	720	1635000000
DEK 5/5 MM WS	800	2007110000

For detailed information on other accessories and application in the online catalogue



Spring connection with tension clamp technology (Z-Series)

PE terminal blocks

Universal range

A

ZPEA 2.5-2

2.5 mm²

Two connections



Width/Height/Depth	mm
max. current / max. cond. cross-section	-/mm ²
Max. clamping range	mm ²

5.1 x 35 x 30	
/ 4	
0.13...4	

Technical data

Rated data	
for wire cross-section	mm ²
Rated voltage to adjoining terminal	V
Rated impulse withstand voltage to adjacent terminal	kV
Rated short-time current	
Pollution severity	
Gauge to IEC 60947-1 / UL 94 flammability rating	
Approvals	
Clamped conductors (H05V/H07V)	
Solid / Stranded	mm ²
Flexible / Flexible with ferrule	mm ²
Twin wire-end ferrule	-
Stripping length / Blade size	mm/-
Note	

IEC 60947-7-2

IEC	UL	CSA	EN 60079-7
2.5	AWG 26...12	AWG 26...12	4 mm ²
500			
6			
300 A (2.5 mm ²)			
3			
A2 / V-0			

Ex eb II
C Gb II 2 G D

© CE

Rated connection	
0.5...2.5 / 0.5...2.5	
0.5...2.5 / 0.5...2.5	
10 / 0.6 x 3.5 mm	
TS 15 - sliced construction	

Ordering data

Version	Green/yellow
Note	

Type	Qty.	Order No.
ZPEA 2.5-2	100	1720950000

Accessories

End plate / Partition plate	dark beige
End bracket	dark beige beige
Screwdriver	Standard
Reducing sleeves	for conductors < 0.5 mm ² / AWG 20
Marking tags	

Type	Qty.	Order No.
ZAP/TW ZDUA	50	1720960000
ZEW 15	20	7920340000
SDIS SLIM 0.6X3.5X100	1	2749610000
DEK 5/5 MC NE WS	1000	1609801044
WS 10/5 MC NE WS	720	1635000000
DEK 5/5 MM WS	800	2007110000

For detailed information on other accessories and application in the online catalogue

ZPEA 2.5-2N

2.5 mm²

Two connections



5.1 x 42.5 x 35	
/ 4	
0.13...4	

IEC 60947-7-2

IEC	UL	CSA	EN 60079-7
2.5	AWG 26...12	AWG 26...12	
800			
8			
300 A (2.5 mm ²)			
3			
A2 / V-0			

CE

Rated connection	
0.5...2.5 / 0.5...2.5	
0.5...2.5 / 0.5...2.5	
10 / 0.6 x 3.5 mm	
TS 15 - sliced construction	

Type	Qty.	Order No.
ZPEA 2.5-2N	50	1808210000

Type	Qty.	Order No.
ZAP/TW ZDUA2.5-2N	50	1808170000
ZEW 15	20	7920340000
SDIS SLIM 0.6X3.5X100	1	2749610000
DEK 5/5 MC NE WS	1000	1609801044
WS 10/5 MC NE WS	720	1635000000
DEK 5/5 MM WS	800	2007110000

For detailed information on other accessories and application in the online catalogue

ZPEB 2.5-2

2.5 mm²

Two connections



5.1 x 33.5 x 31
/ 4
0.13...4

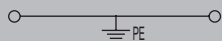

IEC 60947-7-2 Ex eb II C Gb II 2 G D

IEC	UL	CSA	EN 60079-7
2.5	AWG 26...12	AWG 26...12	4 mm ²
800			
8			
	300 A (2.5 mm ²)		
	3		
	A2 / V-0		

Rated connection

0.5...4
0.5...2.5 / 0.5...1.5

10 / 0.6 x 3.5 mm

TS 15 - block construction

Type	Qty.	Order No.
ZPEB 2.5-2	100	1712810000

Type	Qty.	Order No.
ZAP ZDUB	50	1704750000
ZEW 15	20	7920340000
SDIS SLIM 0.6X3.5X100	1	2749610000
DEK 5/5 MC NE WS	1000	1609801044
WS 10/5 MC NE WS	720	1635000000
DEK 5/5 MM WS	800	2007110000

ZPE 1.5

1.5 mm²

Two connections

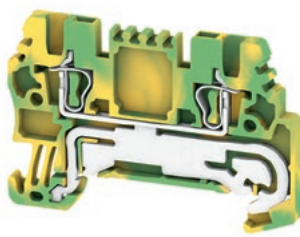

3.5 x 54.5 x 36.5
/ 1.5
0.05...1.5

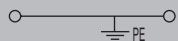

IEC 60947-7-2 Ex eb II C Gb II 2 G D

IEC	UL	CSA	EN 60079-7
1.5	AWG 26...14	AWG 26...14	1.5 mm ²
500			
6			
	180 A (1.5 mm ²)		
	3		
	B1 / V-0		

Rated connection

0.5...1.5
0.5...1.5 / 0.5...1.5
0.5...0.75
10 / 0.4 x 2.0 mm

Type	Qty.	Order No.
ZPE 1.5	50	1775510000

Type	Qty.	Order No.
ZAP/TW ZDU1.5/2AN	20	1776030000
ZEW 35	20	9540000000
SDS 0.4X2.0X60	1	2749260000
ZRH 1.5S/1	500	1781950000
DEK 5/3.5 MC NE WS	500	1755270000
WS 12/3.5 MC NE WS	600	1778270000
DEK 5/3.5 MM WS	1000	2007100000

ZPE 1.5/3AN

1.5 mm²

Three connections

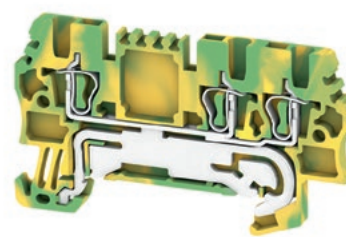

3.5 x 63 x 36.5
/ 1.5
0.05...1.5



IEC 60947-7-2 Ex eb II C Gb II 2 G D

IEC	UL	CSA	EN 60079-7
1.5	AWG 26...14	AWG 26...14	1.5 mm ²
500			
6			
	180 A (1.5 mm ²)		
	3		
	B1 / V-0		

Rated connection

0.5...1.5
0.5...1.5 / 0.5...1.5
0.5...0.75
10 / 0.4 x 2.0 mm

Type	Qty.	Order No.
ZPE 1.5/3AN	50	1775560000

Type	Qty.	Order No.
ZAP/TW ZDU1.5/3AN	20	1776060000
ZEW 35	20	9540000000
SDS 0.4X2.0X60	1	2749260000
ZRH 1.5S/1	500	1781950000
DEK 5/3.5 MC NE WS	500	1755270000
WS 12/3.5 MC NE WS	600	1778270000
DEK 5/3.5 MM WS	1000	2007100000

Spring connection with tension clamp technology (Z-Series)

PE terminal blocks

Universal range

A

ZPE 1.5/4AN

1.5 mm²

Four connections

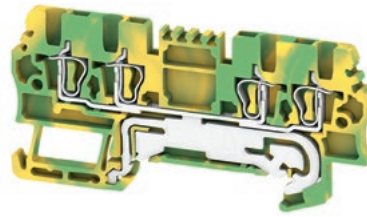

Width/Height/Depth	mm
max. current / max. cond. cross-section	-/mm ²
Max. clamping range	mm ²

3.5 x 75.5 x 36.5	
/ 1.5	
0.05...1.5	

Technical data

Rated data	
for wire cross-section	mm ²
Rated voltage to adjoining terminal	V
Rated impulse withstand voltage to adjacent terminal	kV
Rated short-time current	
Pollution severity	
Gauge to IEC 60947-1 / UL 94 flammability rating	
Approvals	
Clamped conductors (H05V/H07V)	
Solid / Stranded	mm ²
Flexible / Flexible with ferrule	mm ²
Twin wire-end ferrule	mm ²
Stripping length / Blade size	mm/-
Note	

IEC 60947-7-2 Ex eb II C Gb II 2 G D

IEC	UL	CSA	EN 60079-7
1.5	AWG 26...14	AWG 26...12	1.5 mm ²
500			
6			
180 A (1.5 mm ²)			
3			
B1 / V-0			
Rated connection			
0.5...1.5			
0.5...1.5 / 0.5...1.5			
0.5...0.75			
10 / 0.4 x 2.0 mm			

Ordering data

Version	Green/yellow
Note	

Accessories

End plate / Partition plate	dark beige
End bracket	dark beige
Test adapter	Standard With spigot
Screwdriver	Standard
Reducing sleeves	for conductors < 0.5 mm ² / AWG 20 for conductors < 1.0 mm ² / AWG 18
Marking tags	

For detailed information on other accessories and application in the online catalogue

ZPE 2.5

2.5 mm²

Two connections



5.1 x 63 x 38.5	
/ 4	
0.05...4	

IEC 60947-7-2 Ex eb II C Gb II 2 G D

IEC	UL	CSA	EN 60079-7
2.5	AWG 30...12	AWG 26...12	4 mm ²
800			
8			
300 A (2.5 mm ²)			
3			
A3 / V-0			
Rated connection			
0.5...4			
0.5...4 / 0.5...2.5			
10 / 0.6 x 3.5 mm			

Type	Qty.	Order No.
ZPE 2.5	50	1608640000

Type	Qty.	Order No.	
ZAP/TW 1	50	1608740000	
ZEW 35	20	9540000000	
ZTA 1	9 A	25	1609040000
ZTA 1/ZA	9 A	25	1609050000
SDIS SLIM 0.6X3.5X100	1	2749610000	
ZRH 2.5/1 WS	1000	1614300000	
ZRH 2.5/2 GR/V0	1000	1614290000	
DEK 5/5 MC NE WS	1000	1609801044	
WS 10/5 MC NE WS	720	1635000000	
DEK 5/5 MM WS	800	2007110000	

For detailed information on other accessories and application in the online catalogue

ZPE 2.5/3AN

2.5 mm²

Three connections



5.1 x 64.5 x 38.5
/ 4
0.05...4

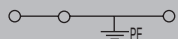

IEC 60947-7-2 Ex eb II C Gb II 2 G D

IEC	UL	CSA	EN 60079-7
2.5	AWG 30...12	AWG 26...12	4 mm ²
800			
8			
300 A (2.5 mm ²)			
3			
A3 / V-0			

Rated connection

0.5...4
0.5...4 / 0.5...2.5

10 / 0.6 x 3.5 mm

Type	Qty.	Order No.
ZPE 2.5/3AN	50	1608650000

Type	Qty.	Order No.	
ZAP/TW 2 DB	50	1608770000	
ZEW 35	20	9540000000	
ZTA 1	9 A	25	1609040000
ZTA 1/ZA	9 A	25	1609050000
SDIS SLIM 0.6X3.5X100	1	2749610000	
ZRH 2.5/1 WS	1000	1614300000	
ZRH 2.5/2 GR/VO	1000	1614290000	
DEK 5/5 MC NE WS	1000	1609801044	
WS 10/5 MC NE WS	720	1635000000	
DEK 5/5 MM WS	800	2007110000	

ZPE 2.5/4AN

2.5 mm²

Four connections



5.1 x 79.5 x 38.5
/ 4
0.05...4



IEC 60947-7-2 Ex eb II C Gb II 2 G D

IEC	UL	CSA	EN 60079-7
2.5	AWG 30...12	AWG 26...12	4 mm ²
800			
8			
300 A (2.5 mm ²)			
3			
A3 / V-0			

Rated connection

0.5...4
0.5...4 / 0.5...2.5

10 / 0.6 x 3.5 mm

Type	Qty.	Order No.
ZPE 2.5/4AN	50	1608660000

Type	Qty.	Order No.	
ZAP/TW 3	50	1608800000	
ZEW 35	20	9540000000	
ZTA 1	9 A	25	1609040000
ZTA 1/ZA	9 A	25	1609050000
SDIS SLIM 0.6X3.5X100	1	2749610000	
ZRH 2.5/1 WS	1000	1614300000	
ZRH 2.5/2 GR/VO	1000	1614290000	
DEK 5/5 MC NE WS	1000	1609801044	
WS 10/5 MC NE WS	720	1635000000	
DEK 5/5 MM WS	800	2007110000	

ZPE 4

4 mm²

Two connections



6.1 x 62.5 x 43
/ 6
0.13...6

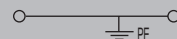

IEC 60947-7-2 Ex eb II C Gb II 2 G D

IEC	UL	CSA	EN 60079-7
4		AWG 26...10	6 mm ²
800			
8			
480 A (4 mm ²)			
3			
A4 / V-0			

Rated connection

0.5...6 / 1.5...6
0.5...6 / 0.5...4

12 / 0.6 x 3.5 mm

Type	Qty.	Order No.
ZPE 4	50	1632080000

Type	Qty.	Order No.	
ZAP/TW 4	50	1632090000	
ZEW 35	20	9540000000	
ZTA 2 ZDU4	9 A	25	1609060000
ZTA 2/ZA ZDU4	9 A	25	1609070000
SDIS SLIM 0.6X3.5X100	1	2749610000	
ZRH 4/1 WS	1000	1636640000	
DEK 5/6 MC NE WS	1000	1609820000	
WS 12/6 MC NE WS	600	1609900000	
DEK 5/6 MM WS	600	2007120000	



Spring connection with tension clamp technology (Z-Series)

PE terminal blocks

Universal range

A

ZPE 4/3 AN

4 mm²

Three connections



ZPE 4/4 AN

4 mm²

Four connections



Width/Height/Depth	mm
max. current / max. cond. cross-section	-/mm ²
Max. clamping range	mm ²

6.1 x 85.5 x 43	
/ 6	
0.13...6	

6.1 x 104.5 x 43	
/ 6	
0.13...6	

Technical data

Rated data	
for wire cross-section	mm ²
Rated voltage to adjoining terminal	V
Rated impulse withstand voltage to adjacent terminal	kV
Rated short-time current	
Pollution severity	
Gauge to IEC 60947-1 / UL 94 flammability rating	
Approvals	

IEC 60947-7-2 Ex eb II C Gb II 2 G D

IEC	UL	CSA	EN 60079-7
4		AWG 26...10	6 mm ²
800			
8			
480 A (4 mm ²)			
3			
A4 / V-0			

IEC 60947-7-2 Ex eb II C Gb II 2 G D

IEC	UL	CSA	EN 60079-7
4		AWG 26...10	6 mm ²
800			
8			
480 A (4 mm ²)			
3			
A4 / V-0			

Clamped conductors (H05V/H07V)

Solid / Stranded	mm ²
Flexible / Flexible with ferrule	mm ²
Twin wire-end ferrule	-
Stripping length / Blade size	mm/-

Rated connection		
0.5...6 / 0.5...6		
0.5...6 / 0.5...4		
12 / 0.6 x 3.5 mm		

Rated connection		
0.5...6 / 0.5...6		
0.5...6 / 0.5...4		
12 / 0.6 x 3.5 mm		

Note

Ordering data

Version	Green/yellow
Note	

Type	Qty.	Order No.
ZPE 4/3AN	50	7904170000

Type	Qty.	Order No.
ZPE 4/4AN	50	7904280000

Accessories

End plate / Partition plate	dark beige
End bracket	dark beige
Test adapter	Standard With spigot
Screwdriver	Standard
Reducing sleeves	for conductors < 0.5 mm ² / AWG 20 for conductors < 1.0 mm ² / AWG 18
Marking tags	

Type	Qty.	Order No.
ZAP/TW 4/3AN	20	7904100000
ZEW 35	20	9540000000
ZTA 2 ZDU4	9 A 25	1609060000
ZTA 2/ZA ZDU4	9 A 25	1609070000
SDIS SLIM 0.6X3.5X100	1	2749610000
ZRH 4/1 WS	1000	1636640000
DEK 5/6 MC NE WS	1000	1609820000
WS 12/6 MC NE WS	600	1609900000
DEK 5/6 MM WS	600	2007120000

Type	Qty.	Order No.
ZAP/TW4/4AN	20	7904210000
ZEW 35	20	9540000000
ZTA 2 ZDU4	9 A 25	1609060000
ZTA 2/ZA ZDU4	9 A 25	1609070000
SDIS SLIM 0.6X3.5X100	1	2749610000
ZRH 4/1 WS	1000	1636640000
DEK 5/6 MC NE WS	1000	1609820000
WS 12/6 MC NE WS	600	1609900000
DEK 5/6 MM WS	600	2007120000

For detailed information on other accessories and application in the online catalogue

ZPE 6

6 mm²

Two connections



8.1 x 65 x 45
/ 10
0.22...10



IEC 60947-7-2 Ex eb II C Gb II 2 G D

IEC	UL	CSA	EN 60079-7
6	AWG 22...8	AWG 20...8	10 mm ²
800			
8			
720 A (6 mm ²)			
3			
A5 / V-0			



Rated connection

0.5...10 / 1.5...10
0.5...10 / 0.5..6

13 / 0.6 x 3.5 mm

Type	Qty.	Order No.
ZPE 6	50	1608670000

Type	Qty.	Order No.
ZAP/TW 5	50	1608830000
ZEW 35	20	9540000000
ZTA 3 ZDU6	9 A 25	1654050000
SDS 1.0X5.5X150	1	2749380000
DEK 5/8 MC NE WS	800	1856740000
WS 12/6 MC NE WS	600	1609900000
DEK 5/8 MM WS	500	2007130000
WS 8/8 MM WS	500	2007170000

ZPE 6/3 AN

6 mm²

Three connections



8.1 x 90 x 45
/ 10
0.22...10

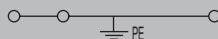

IEC 60947-7-2 Ex eb II C Gb II 2 G D

IEC	UL	CSA	EN 60079-7
6	AWG 22...8	AWG 20...8	10 mm ²
800			
8			
720 A (6 mm ²)			
3			
A5 / V-0			



Rated connection

0.5...10 / 1.5...10
0.5...10 / 0.5..6

13 / 0.6 x 3.5 mm

Type	Qty.	Order No.
ZPE 6/3AN	50	7907400000

Type	Qty.	Order No.
ZAP/TW6/3AN	20	7907370000
ZEW 35	20	9540000000
ZTA 3 ZDU6	9 A 25	1654050000
SDS 1.0X5.5X150	1	2749380000
DEK 5/8 MC NE WS	800	1856740000
WS 12/6 MC NE WS	600	1609900000
DEK 5/8 MM WS	500	2007130000
WS 8/8 MM WS	500	2007170000



Spring connection with tension clamp technology (Z-Series)

PE terminal blocks

ZPE 10

10 mm²

Two connections



ZPE 10/3 AN

10 mm²

Three connections



Width/Height/Depth	mm
max. current / max. cond. cross-section	-/mm ²
Max. clamping range	mm ²

10.1 x 73.5 x 49.5
/ 16
1.31...16

10.1 x 99 x 49.5
/ 16
1.31...16

Technical data

Rated data	
for wire cross-section	mm ²
Rated voltage to adjoining terminal	V
Rated impulse withstand voltage to adjacent terminal	kV
Rated short-time current	
Pollution severity	
Gauge to IEC 60947-1 / UL 94 flammability rating	
Approvals	

IEC 60947-7-2

IEC	UL	CSA	EN 60079-7
10	AWG 16...6	AWG 16...6	16 mm ²
800			
8			
1200 A (10 mm ²)			
3			
A6 / V-0			

Ex eb II
C Gb II 2 G D

IEC 60947-7-2

IEC	UL	CSA	EN 60079-7
10	AWG 16...6	AWG 16...6	16 mm ²
800			
8			
1200 A (10 mm ²)			
3			
A6 / V-0			

Ex eb II
C Gb II 2 G D

Clamped conductors (H05V/H07V)

Solid / Stranded	mm ²
Flexible / Flexible with ferrule	mm ²
Twin wire-end ferrule	-
Stripping length / Blade size	mm/-

Rated connection
1.5...16 / 1.5...16
1.5...10 / 1.5...10
18 / 1.0 x 5.5 mm

Rated connection
1.5...16 / 1.5...16
1.5...10 / 1.5...10
18 / 1.0 x 5.5 mm

Note

Ordering data

Version	Green/yellow
Note	

Type	Qty.	Order No.
ZPE 10	25	1746770000

Type	Qty.	Order No.
ZPE 10/3AN	20	1767670000

Accessories

End plate / Partition plate	dark beige
End bracket	dark beige
Screwdriver	Standard
Marking tags	

Type	Qty.	Order No.
ZAP/TW ZDU10	20	1748660000
ZEW 35	20	9540000000
SDS 1.0X5.5X150	1	2749380000
DEK 5/5 MC NE WS	1000	1609801044
WS 12/6 MC NE WS	600	1609900000

Type	Qty.	Order No.
ZAP/TW 10/16	20	1749580000
ZEW 35	20	9540000000
SDS 1.0X5.5X150	1	2749380000
DEK 5/5 MC NE WS	1000	1609801044
WS 12/6 MC NE WS	600	1609900000

For detailed information on other accessories and application in the online catalogue

ZPE 16

16 mm²

Two connections



12.1 x 82.5 x 50.5
/ 25
1.5...25

Ex eb II
C Gb II 2 G D

IEC	UL	CSA	EN 60079-7
16	AWG 14...6	AWG 14...4	25 mm ²
800			
8			
1920 A (16 mm ²)			
3			
A7 / V-0			

Rated connection
1.5...16 / 1.5...25
1.5...16 / 1.5...16

18 / 1.0 x 5.5 mm

To ensure the current-carrying capacity of the mounting rail, it is necessary to use the TS 35 x 15.

Type	Qty.	Order No.
ZPE 16	25	1745250000

Type	Qty.	Order No.
ZAP/TW ZDU16	20	1745150000
ZEW 35	20	9540000000
SDS 1.0X5.5X150	1	2749380000
DEK 5/5 MC NE WS	1000	1609801044
WS 15/5 MC NE WS	480	1609880000

The plug-in cross-connections ZDV 16/2 (1739690000) can be used.

ZPE 16/3AN

16 mm²

Three connections



12.1 x 99 x 50.5
/ 25
1.5...25

Ex eb II
C Gb II 2 G D

IEC	UL	CSA	EN 60079-7
16	AWG 14...4	AWG 14...4	25 mm ²
800			
8			
1920 A (16 mm ²)			
3			
A7 / V-0			

Rated connection
1.5...16 / 1.5...25
1.5...16 / 1.5...16

18 / 1.0 x 5.5 mm

To ensure the current-carrying capacity of the mounting rail, it is necessary to use the TS 35 x 15.

Type	Qty.	Order No.
ZPE 16/3AN	20	1768310000

Type	Qty.	Order No.
ZAP/TW 10/16	20	1749580000
ZEW 35	20	9540000000
SDS 1.0X5.5X150	1	2749380000
DEK 5/5 MC NE WS	1000	1609801044
WS 15/5 MC NE WS	480	1609880000

The plug-in cross-connections ZDV 16/2 (1739690000) can be used.

ZPE 35

35 mm²

Two connections

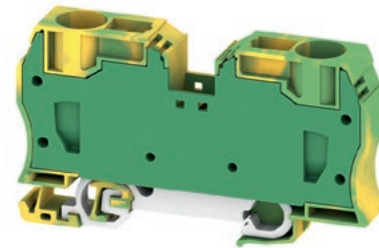

16 x 100.5 x 58.5
/ 35
2.5...35

Ex eb II
C Gb II 2 G D

IEC	UL	CSA	EN 60079-7
35	AWG 12...2	AWG 12...2	35 mm ²
800			
8			
4200 A (35 mm ²)			
3			
A8 / V-0			

Rated connection
2.5...16 / 2.5...35
2.5...35 / 2.5...35

25 / 1.0 x 5.5 mm

To ensure the current-carrying capacity of the mounting rail, it is necessary to use the TS 35 x 15.

Type	Qty.	Order No.
ZPE 35	10	1739650000

Integrated end plate.

Type	Qty.	Order No.
ZEW 35	20	9540000000
SDS 1.0X5.5X150	1	2749380000
DEK 5/5 MC NE WS	1000	1609801044
WS 15/5 MC NE WS	480	1609880000

The plug-in cross-connections ZDV 35/2 (1739700000) can be used.



Spring connection with tension clamp technology (Z-Series)

PE terminal blocks

Universal range

A

ZPE 2.5-2

2.5 mm²

Two connections



ZPE 2.5-2/3AN

2.5 mm²

Three connections



Width/Height/Depth	mm
max. current / max. cond. cross-section	-/mm ²
Max. clamping range	mm ²

5.1 x 50.5 x 43.5	
/ 4	
0.13...4	

5.1 x 50.5 x 43.5	
/ 4	
0.13...4	

Technical data

Rated data	
for wire cross-section	mm ²
Rated voltage to adjoining terminal	V
Rated impulse withstand voltage to adjacent terminal	kV
Rated short-time current	
Pollution severity	
Gauge to IEC 60947-1 / UL 94 flammability rating	
Approvals	
Clamped conductors (H05V/H07V)	
Solid / Stranded	mm ²
Flexible / Flexible with ferrule	mm ²
Twin wire-end ferrule	-
Stripping length / Blade size	mm/-

IEC 60947-7-2				Ex eb II		II 2 G D
				C Gb		
IEC	UL	CSA	EN 60079-7			
2.5	AWG 26...12	AWG 26...12	4 mm ²			
800						
8						
300 A (2.5 mm ²)						
3						
A2 / V-0						
Rated connection						
0.5...4						
0.5...2.5 / 0.5...1.5						
10 / 0.6 x 3.5 mm						

IEC 60947-7-2				Ex eb II		II 2 G D
				C Gb		
IEC	UL	CSA	EN 60079-7			
2.5	AWG 26...12	AWG 26...14	4 mm ²			
800						
8						
300 A (2.5 mm ²)						
3						
A2 / V-0						
Rated connection						
0.5...2.5						
0.5...2.5 / 0.5...1.5						
10 / 0.6 x 3.5 mm						

Note

Ordering data

Version	
	Green/yellow
Note	

Type	Qty.	Order No.
ZPE 2.5-2	50	1772090000

Type	Qty.	Order No.
ZPE 2.5-2/3AN	50	1706090000

Accessories

End plate / Partition plate	
	dark beige
End bracket	dark beige
Test adapter	With spigot
Screwdriver	Standard
Reducing sleeves	for conductors < 0.5 mm ² / AWG 20 for conductors < 1.0 mm ² / AWG 18
Marking tags	

Type	Qty.	Order No.
ZAP/TW7	50	1706110000
ZEW 35	20	9540000000
ZTA 4	11 A 25	1688110000
SDIS SLIM 0.6X3.5X100	1	2749610000
ZRH 1.5H/1	1000	1678810000
ZRH 1.5H/2	1000	1678800000
DEK 5/5 MC NE WS	1000	1609801044
WS 8/5 MM WS	800	2007150000
DEK 5/5 MM WS	800	2007110000

Type	Qty.	Order No.
ZAP/TW7	50	1706110000
ZEW 35	20	9540000000
ZTA 4	11 A 25	1688110000
SDIS SLIM 0.6X3.5X100	1	2749610000
ZRH 1.5H/1	1000	1678810000
ZRH 1.5H/2	1000	1678800000
WS 8/5 MM WS	800	2007150000
DEK 5/5 MM WS	800	2007110000

For detailed information on other accessories and application in the online catalogue

ZPE 2.5-2/4AN

2.5 mm²

Four connections



5.1 x 50.5 x 43.5
/ 4
0.13...4



IEC 60947-7-2 Ex eb II C Gb II 2 G D

IEC	UL	CSA	EN 60079-7
2.5	AWG 26...12	AWG 26...14	4 mm ²
800			
8			
	300 A (2.5 mm ²)		
	3		
	A2 / V-0		

Rated connection

0.5...4
0.5...2.5 / 0.5...1.5

10 / 0.6 x 3.5 mm

Type	Qty.	Order No.
ZPE 2.5-2/4AN	50	1706100000

Type	Qty.	Order No.
ZAP/TW7	50	1706110000
ZEW 35	20	9540000000
ZTA 4	11 A 25	1688110000
SDIS SLIM 0.6X3.5X100	1	2749610000
ZRH 1.5H/1	1000	1678810000
ZRH 1.5H/2	1000	1678800000
DEK 5/5 MC NE WS	1000	1609801044
WS 10/5 MC NE WS	720	1635000000
DEK 5/5 MM WS	800	2007110000

ZPE 4-2/2AN

4 mm²

Two connections



6.1 x 61.5 x 45.5
/ 6
0.13...6

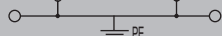

IEC 60947-7-2 Ex eb II C Gb II 2 G D

IEC	UL	CSA	EN 60079-7
4	AWG 26...10	AWG 26...10	6 mm ²
800			
8			
	480 A (4 mm ²)		
	3		
	A3 / V-0		

Rated connection

0.5...6
0.5...4 / 0.5...4

10 / 0.6 x 3.5 mm

Type	Qty.	Order No.
ZPE 4-2/2AN	50	1770380000

Type	Qty.	Order No.
ZAP ZDU4-2	50	1770400000
ZEW 35	20	9540000000
ZTA 6/ZA	17.5 A 25	1780660000
SDIS SLIM 0.6X3.5X100	1	2749610000
ZRH 4/1 WS	1000	1636640000
DEK 5/6 MC NE WS	1000	1609820000
WS 12/6 MC NE WS	600	1609900000
DEK 5/6 MM WS	600	2007120000

ZPE 4-2/3AN

4 mm²

Three connections



6.1 x 61.5 x 45.5
/ 6
0.13...6



IEC 60947-7-2 Ex eb II C Gb II 2 G D

IEC	UL	CSA	EN 60079-7
4	AWG 26...10	AWG 26...10	6 mm ²
800			
8			
	480 A (4 mm ²)		
	3		
	A3 / V-0		

Rated connection

0.5...6
0.5...4 / 0.5...4

10 / 0.6 x 3.5 mm

Type	Qty.	Order No.
ZPE 4-2/3AN	50	1770390000

Type	Qty.	Order No.
ZAP ZDU4-2	50	1770400000
ZEW 35	20	9540000000
ZTA 6/ZA	17.5 A 25	1780660000
SDIS SLIM 0.6X3.5X100	1	2749610000
ZRH 4/1 WS	1000	1636640000
DEK 5/6 MC NE WS	1000	1609820000
WS 12/6 MC NE WS	600	1609900000
DEK 5/6 MM WS	600	2007120000

Spring connection with tension clamp technology (Z-Series)

PE terminal blocks

Universal range

A

ZPE 4-2/4 AN

4 mm²

Four connections



ZPE 6-2/2AN

6 mm²

Two connections



Width/Height/Depth	mm
max. current / max. cond. cross-section	-/mm ²
Max. clamping range	mm ²

6.1 x 75 x 45.5	
/ 6	
0.13...6	

8.1 x 68 x 49.19	
/ 10	
0.22...10	

Technical data

Rated data	
for wire cross-section	mm ²
Rated voltage to adjoining terminal	V
Rated impulse withstand voltage to adjacent terminal	kV
Rated short-time current	
Pollution severity	
Gauge to IEC 60947-1 / UL 94 flammability rating	
Approvals	
Clamped conductors (H05V/H07V)	
Solid / Stranded	mm ²
Flexible / Flexible with ferrule	mm ²
Twin wire-end ferrule	-
Stripping length / Blade size	mm/-

IEC 60947-7-2 Ex eb II C Gb II 2 G D

IEC	UL	CSA	EN 60079-7
4	AWG 26...10	AWG 26...10	6 mm ²
800			
8			
	480 A (4 mm ²)		
	3		
	A3 / V-0		

Rated connection	
0.5...6	
0.5...4 / 0.5...4	
10 / 0.6 x 3.5 mm	

IEC 60947-7-2 Ex eb II C Gb II 2 G D

IEC	UL	CSA	EN 60079-7
6	AWG 22...8	AWG 20...8	10 mm ²
800			
8			
	720 A (6 mm ²)		
	3		
	A5 / V-0		

Rated connection	
0.5...10	
0.5...10 / 0.5...6	
12 / 0.6 x 3.5 mm	

Note

Ordering data

Version	
	Green/yellow
Note	

Type	Qty.	Order No.
ZPE 4-2/4AN	50	1807090000

Type	Qty.	Order No.
ZPE 6-2/2AN	50	1771370000

Accessories

End plate / Partition plate	
	dark beige
End bracket	
	dark beige
Test adapter	
	With spigot
Screwdriver	
	Standard
Reducing sleeves	
	for conductors < 0.5 mm ² / AWG 20
	for conductors < 1.0 mm ² / AWG 18
Marking tags	

Type	Qty.	Order No.
ZAP ZDU4-2/4AN	50	1807010000
ZEW 35	20	9540000000
ZTA 6/ZA	17.5 A 25	1780660000
SDIS SLIM 0.6X3.5X100	1	2749610000
ZRH 4/1 WS	1000	1636640000
DEK 5/6 MC NE WS	1000	1609820000
WS 12/6 MC NE WS	600	1609900000
DEK 5/6 MM WS	600	2007120000

Type	Qty.	Order No.
ZAP ZDU6-2	50	1771440000
ZEW 35	20	9540000000
ZTA 7/ZA	9 A 25	1780670000
SDIS SLIM 0.6X3.5X100	1	2749610000
DEK 5/8 MC NE WS	800	1856740000
DEK 5/8 MM WS	500	2007130000
WS 8/8 MM WS	500	2007170000

For detailed information on other accessories and application in the online catalogue

ZPE 6-2/3AN

6 mm²

Three connections



8.1 x 68 x 49.19
/ 10
0.22...10

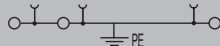

IEC 60947-7-2 Ex eb II C Gb II 2 G D

IEC	UL	CSA	EN 60079-7
6	AWG 22...8	AWG 20...8	10 mm ²
800			
8			
	720 A (6 mm ²)		
	3		
	A5 / V-0		

Rated connection

0.5...10
0.5...10 / 0.5...6

12 / 0.6 x 3.5 mm

Type	Qty.	Order No.
ZPE 6-2/3AN	50	1771360000

Type	Qty.	Order No.
ZAP ZDU6-2	50	1771440000
ZEW 35	20	9540000000
ZTA 7/ZA	9 A 25	1780670000
SDIS SLIM 0.8X4.0X100	1	2749620000
DEK 5/8 MC NE WS	800	1856740000
DEK 5/8 MM WS	500	2007130000
WS 8/8 MM WS	500	2007170000

ZPE 16-2/1AN

16 mm²

Supply terminal - PE



12 x 65 x 50.5
/ 25
1.5...25

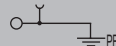

In accordance with IEC 60947-7-1, IEC 60947-7-2

IEC	UL	CSA	EN 60079-7
16	AWG 14...4	AWG 26...14	
800			
8			
	1920 A (16 mm ²)		
	3		
	A7 / V-0		

Rated connection

1.5...10 / 16...25
1.5...16 / 1.5...16

18 / 1.0 x 5.5 mm

Type	Qty.	Order No.
ZPE 16-2/1AN	20	1772960000

Type	Qty.	Order No.
ZAP/Z...16-2/1AN	10	1772970000
ZEW 35	20	9540000000
SDS 1.0X5.5X150	1	2749380000
DEK 5/8 MC NE WS	800	1856740000

The plug-in cross-connections ZQV 2.5/... ZQV 4/... and ZQV 6/... can be used.



Spring connection with tension clamp technology (Z-Series)

PE terminal blocks

Universal range

A

ZPE 2.5N

2.5 mm²

Two connections

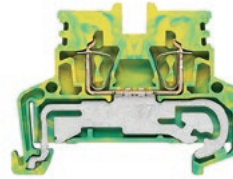

ZPE 2.5N/3AN

2.5 mm²

Three connections

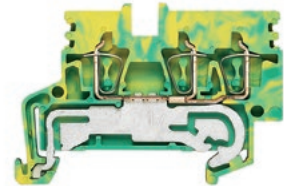

Width/Height/Depth	mm
max. current / max. cond. cross-section	-/mm ²
Max. clamping range	mm ²

5.1 x 50.5 x 38.5
/ 4
0.05...4

5.1 x 56.5 x 38.5
/ 4
0.05...4

Technical data

Rated data	
for wire cross-section	mm ²
Rated voltage to adjoining terminal	V
Rated impulse withstand voltage to adjacent terminal	kV
Rated short-time current	
Pollution severity	
Gauge to IEC 60947-1 / UL 94 flammability rating	
Approvals	

IEC 60947-7-2 Ex eb II C Gb II 2 G D

IEC	UL	CSA	EN 60079-7
2.5	AWG 30...12	AWG 30...12	2.5 mm ²
800			
6			
300 A (2.5 mm ²)			
3			
A2 / V-0			

IEC 60947-7-2 Ex eb II C Gb II 2 G D

IEC	UL	CSA	EN 60079-7
2.5	AWG 30...12	AWG 30...12	2.5 mm ²
800			
6			
300 A (2.5 mm ²)			
3			
A2 / V-0			

Clamped conductors (H05V/H07V)	
Solid / Stranded	mm ²
Flexible / Flexible with ferrule	mm ²
Twin wire-end ferrule	-
Stripping length / Blade size	mm/-

Rated connection
0.5...4 / 1.5...2.5
0.5...2.5 / 0.5...1.5
10 / 0.6 x 3.5 mm

Rated connection
0.5...4 / 1.5...2.5
0.5...2.5 / 0.5...1.5
10 / 0.6 x 3.5 mm

Note

Ordering data

Version	Green/yellow
Note	

Type	Qty.	Order No.
ZPE 2.5N	50	1933760000

Type	Qty.	Order No.
ZPE 2.5N/3AN	50	1933770000

Accessories

End plate / Partition plate	dark beige
End bracket	dark beige
Test adapter	Standard With spigot
Screwdriver	Standard
Reducing sleeves	for conductors < 0.5 mm ² / AWG 20 for conductors < 1.0 mm ² / AWG 18
Marking tags	

Type	Qty.	Order No.	
ZAP/TW ZDU/ZPE 2.5N	20	1933790000	
ZEW 35	20	9540000000	
ZTA ZT2.5	17.5 A	25	1827080000
ZTA ZT2.5/ZA	17.5 A	25	1847600000
SDIS SLIM 0.6X3.5X100	1	2749610000	
ZRH 1.5H/1	1000	1678810000	
ZRH 1.5H/2	1000	1678800000	
DEK 5/5 MC NE WS	1000	1609801044	
WS 10/5 M MC NE WS	720	1792000000	
WS 8/5 MM WS	800	2007150000	

Type	Qty.	Order No.	
ZAP/TW ZDU/ZPE 2.5N/3AN	50	1933800000	
ZEW 35	20	9540000000	
ZTA ZT2.5	17.5 A	25	1827080000
ZTA ZT2.5/ZA	17.5 A	25	1847600000
SDIS SLIM 0.6X3.5X100	1	2749610000	
ZRH 1.5H/1	1000	1678810000	
ZRH 1.5H/2	1000	1678800000	
DEK 5/5 MC NE WS	1000	1609801044	
WS 10/5 M MC NE WS	720	1792000000	
WS 8/5 MM WS	800	2007150000	

For detailed information on other accessories and application in the online catalogue

ZPE 2.5N/4AN

2.5 mm²

Four connections

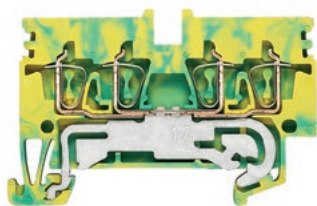

5.1 x 60 x 38.5

/ 4

0.05...4



Ex eb II

C Gb



II 2 G D

IEC 60947-7-2

IEC	UL	CSA	EN 60079-7
2.5	AWG 30...12	AWG 30...12	2.5 mm ²
800			
6			
	300 A (2.5 mm ²)		
	3		
	A2 / V-0		

© CE S PA III

Rated connection

0.5...4 / 1.5...2.5

0.5...2.5 / 0.5...1.5

10 / 0.6 x 3.5 mm

Type	Qty.	Order No.
ZPE 2.5N/4AN	50	1933780000

Type	Qty.	Order No.
ZAP/TW ZDU/ZPE 2.5N/4AN	50	1933810000
ZEW 35	20	9540000000
ZTA ZT2.5	17.5 A 25	1827080000
ZTA ZT2.5/ZA	17.5 A 25	1847600000
SDIS SLIM 0.6X3.5X100	1	2749610000
ZRH 1.5H/1	1000	1678810000
ZRH 1.5H/2	1000	1678800000
DEK 5/5 MC NE WS	1000	1609801044
WS 10/5 M MC NE WS	720	1792000000
WS 8/5 MM WS	800	2007150000



Spring connection with tension clamp technology (Z-Series)

PE terminal blocks

ZDK 1.5 PE

1.5 mm²

Double-level terminal

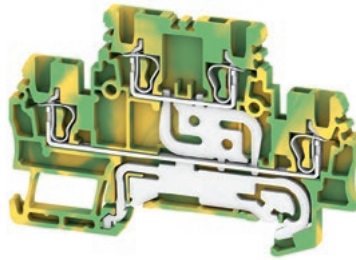

Width/Height/Depth	mm
max. current / max. cond. cross-section	-/mm ²
Max. clamping range	mm ²

3.5 x 75.5 x 49.5	
/ 1.5	
0.05...1.5	

Technical data

Rated data	
for wire cross-section	mm ²
Rated voltage to adjoining terminal	V
Rated impulse withstand voltage to adjacent terminal	kV
Rated short-time current	
Pollution severity	
Gauge to IEC 60947-1 / UL 94 flammability rating	
Approvals	
Clamped conductors (H05V/H07V)	
Solid / Stranded	mm ²
Flexible / Flexible with ferrule	mm ²
Twin wire-end ferrule	mm ²
Stripping length / Blade size	mm/-
Note	

Ordering data

Version	Green/yellow
Note	

Accessories

End plate / Partition plate	dark beige
End bracket	dark beige
Test adapter	With spigot Standard
Reducing sleeves	for conductors < 0.5 mm ² / AWG 20 for conductors < 1.0 mm ² / AWG 18
Cover	With lightning flash symbol
Screwdriver	Standard
Marking tags	

For detailed information on other accessories and application in the online catalogue

ZDK 2.5 PE

2.5 mm²

Vertically cross-connected



5.1 x 79.5 x 53	
/ 2.5	
0.05...2.5	

IEC 60947-7-2 Ex eb II C Gb II 2 G D

IEC	UL	CSA	EN 60079-7
1.5	AWG 28...16	AWG 28...16	
500			2.5 mm ²
6			
180 A (1.5 mm ²)		300 A (2.5 mm ²)	
3		3	
B1 / V-0		A2 / V-0	
Rated connection			
0.5...1.5			
0.5...1.5 / 0.5...1.5			
0.5...0.75			
10 / 0.4 x 2.0 mm			

Type	Qty.	Order No.
ZDK 2.5PE	50	1690000000

Type	Qty.	Order No.
ZAP/TW ZDK2.5	20	1674730000
ZEW 35	20	9540000000
ZTA 4	11 A 25	1688110000
ZRH 1.5H/1	1000	1678810000
ZRH 1.5H/2	1000	1678800000
ZAD 9/4	20	1934160000
SDIS SLIM 0.6X3.5X100	1	2749610000
DEK 5/5 PLUS MC NE GE	1000	1907520000
WS 12/5 MC NE WS	720	1609860000
DEK 5/5 MM WS	800	2007110000
WS 8/5 MM WS	800	2007150000

For detailed information on other accessories and application in the online catalogue

ZDK 2.5-2PE

2.5 mm²

Four connections



5.1 x 72.5 x 54.5
/ 4
0.05...4

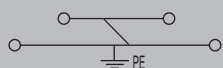

Ex eb II
C Gb II 2 G D

IEC 60947-7-2

IEC	UL	CSA	EN 60079-7
2.5	AWG 26...12	AWG 30...12	4 mm ²
800			
8			
	300 A (2.5 mm ²)		
	3		
	A2 / V-0		

Rated connection

0.5...4
0.5...2.5 / 0.5...2.5

10 / 0.6 x 3.5 mm

Type	Qty.	Order No.
ZDK 2.5-2PE	50	1791010000

Type	Qty.	Order No.
ZAP/TW ZDK2.5-2	20	1791050000
ZEW 35	20	9540000000
ZTA 4	11 A 25	1688110000
ZRH 1.5H/1	1000	1678810000
ZRH 1.5H/2	1000	1678800000
SDS 0.5X3.0X80	1	2749330000
DEK 5/5 MC NE WS	1000	1609801044
DEK 5/5 MM WS	800	2007110000
WS 8/5 MM WS	800	2007150000

ZDK 4-2 PE

4 mm²

Four connections



6.1 x 77.6 x
/ 6
0.13...6

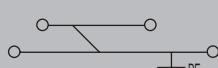

IEC 60947-7-2

IEC	UL	CSA	EN 60079-7
4	AWG 26...10	AWG 26...10	
800			
8			
	480 A (4 mm ²)		
	3		
	A3 /		

Rated connection

0.5...6
0.5...4

10 / 0.6 x 3.5 mm

Type	Qty.	Order No.
ZDK 4-2 PE	50	8671050000

Type	Qty.	Order No.
ZAP/TW ZDK4-2	50	8670760000
ZEW 35	20	9540000000
ZTA 6/ZA	17.5 A 25	1780660000
SDIS SLIM 0.6X3.5X100	1	2749610000
DEK 5/6 MC NE WS	1000	1609820000
DEK 5/6 MM WS	600	2007120000
WS 8/6 MM WS	600	2007160000



Spring connection with tension clamp technology (Z-Series)

PE terminal blocks

ZDK 2.5/3AN PE

2.5 mm²

Double-level terminal

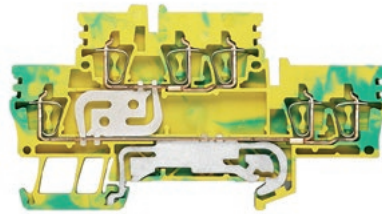

Width/Height/Depth	mm
max. current / max. cond. cross-section	-/mm ²
Max. clamping range	mm ²

5.1 x 93 x 50.5
/ 4
0.05...4

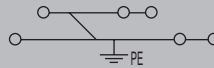

Technical data

Rated data	
for wire cross-section	mm ²
Rated voltage to adjoining terminal	V
Rated impulse withstand voltage to adjacent terminal	kV
Rated short-time current	
Pollution severity	
Gauge to IEC 60947-1 / UL 94 flammability rating	
Approvals	

IEC 60947-7-2 Ex eb II
C Gb II 2 G D

IEC	UL	CSA	EN 60079-7
2.5	AWG 30...12	AWG 30...12	2.5 mm ²
800			
8			
	300 A (2.5 mm ²)		
	3		
	A2 / V-0		

Clamped conductors (H05V/H07V)

Solid / Stranded	mm ²
Flexible / Flexible with ferrule	mm ²
Twin wire-end ferrule	-
Stripping length / Blade size	mm/-

Rated connection

0.5...4 / 0.5...2.5
0.5...2.5 / 0.5...2.5

10 / 0.6 x 3.5 mm

Note

Ordering data

Version	
	Green/yellow
Note	

Type	Qty.	Order No.
ZDK 2.5/3AN PE	50	1924470000

Accessories

End plate / Partition plate	dark beige
End bracket	dark beige
Test adapter	With spigot Standard
Reducing sleeves	for conductors < 0.5 mm ² / AWG 20 for conductors < 1.0 mm ² / AWG 18
Cover	With lightning flash symbol
Screwdriver	Standard
Marking tags	

Type	Qty.	Order No.	
ZAP/TW ZDK 2.5/3AN	20	1924910000	
ZEW 35/2	20	8630740000	
ZTA ZT2.5/ZA	17.5 A	25	1847600000
ZTA ZT2.5	17.5 A	25	1827080000
ZRH 1.5H/1	1000	1678810000	
ZRH 1.5H/2	1000	1678800000	
SDIS SLIM 0.6X3.5X100	1	2749610000	
DEK 5/5 MC NE WS	1000	1609801044	
DEK 5/5 MM WS	800	2007110000	
WS 8/5 MM WS	800	2007150000	
SNAPMARK I	50	1805880000	

For detailed information on other accessories and application in the online catalogue



ZSI 2.5

2.5 mm²

For metric fuses 5 x 20 mm

ZSI 2.5

Overload and short-circuit protection

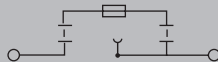

Width/Height/Depth	mm
max. current / max. cond. cross-section	A/mm ²
Max. clamping range	mm ²

7.9 x 79.5 x 73
6.3 / 4
0.13...4

Technical data

Rated data	
Rated voltage to adjoining terminal	V
Rated current	A
for wire cross-section	mm ²
Rated impulse withstand voltage / Pollution severity	
UL 94 flammability rating	
Approvals	
Clamped conductors (H05V/H07V)	
Solid / Stranded	mm ²
Flexible / Flexible with ferrule	mm ²
Blade size	
Note	

IEC 60947-7-3

IEC	UL	CSA	EN 60079-7
500	300 (C)	600 (C)	
6.3	10	15	
2.5	AWG 26...12	AWG 26...12	
6 kV / 3			
V-0			

CE, TÜV, VDE, UL

Rated connection	
0.5...4	
0.5...4 / 0.5...2.5	
0.6 x 3.5 mm	
Max. power loss (1.6 W) at the cartridge fuse limits the rated current.	

Ordering data

Version	
	500 V AC/DC, without LED
Note	

Type	Qty.	Order No.
ZSI 2.5	50	1616400000
The rated voltage for cartridge fuse holders is 250 V and the rated impulse voltage 4 kV.		

Accessories

Plug-in cross-connection	
	2-pole
	4-pole
End plate / Partition plate	
	dark beige
	dark beige
Screwdriver	
	Standard
G-fuse cartridge, 5 x 20 mm (IEC 60127-2)	
	0.25 A fast
	0.50 A fast
	1.00 A fast
	2.00 A fast
Marking tags	

Type	Qty.	Order No.
ZQV 6/2 GE	41 A 60	1627850000
ZQV 6/4 GE	41 A 60	1627870000
ZAP/TW 3	50	1608800000
ZAP TNHE/ZSI2.5	25	1610840000
SDIS SLIM 0.6X3.5X100	1	2749610000
G 20/0.25A/F	0.25 A 10	0430500000
G 20/0.50A/F	0.5 A 10	0430600000
G 20/1.00A/F	1 A 10	0430700000
G 20/2.00A/F	2 A 10	0430900000
DEK 5/5 MC NE WS	1000	1609801044
WS 10/5 MC NE WS	720	1635000000

Type	Order No.
ZSI 2.5	1616400000

Arrangement	Applications			
	Only short-circuit protection		Overload and short-circuit protection	
	T _A max.	Nominal values	T _A max.	Nominal values
Individual	52 °C	4.0 W / 6.3 A	27 °C	2.5 W / 2.5 A
In combination	55 °C	2.5 W / 6.3 A	41 °C	1.6 W / 6.3 A

For detailed information on other accessories and application in the online catalogue



Spring connection with tension clamp technology (Z-Series)

Fuse terminal blocks

ZSI 2.5/QV

2.5 mm²

For metric fuses 5 x 20

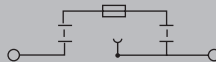
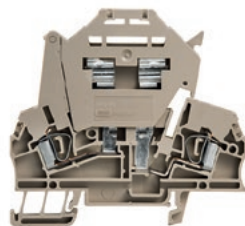

Width/Height/Depth	mm
max. current / max. cond. cross-section	A/mm ²
Max. clamping range	mm ²

7.9 x 79.5 x 73
6.3 / 4
0.13...4

Technical data

Rated data	
Rated voltage to adjoining terminal	V
Rated current	A
for wire cross-section	mm ²
Rated impulse withstand voltage / Pollution severity	
UL 94 flammability rating	
Approvals	
Clamped conductors (H05V/H07V)	
Solid / Stranded	mm ²
Flexible / Flexible with ferrule	mm ²
Blade size	

IEC 60947-7-3

IEC	UL	CSA	EN 60079-7
400			
6.3			
2.5			
		6 kV / 3	
		V-0	

CE

Rated connection	
0.5...4	
0.5...4 / 0.5...2.5	
0.6 x 3.5 mm	

Max. power loss (1.6 W) at the cartridge fuse limits the rated current.

Note

Ordering data

Version	
	dark beige

Note

Type	Qty.	Order No.
ZSI 2.5/QV	50	1799470000

For fuse cartridge holders the rated voltage is 250 V and the rated impulse withstand voltage 4 kV.

Accessories

Plug-in cross-connection	
	2-pole
	4-pole
End plate / Partition plate	
	dark beige
	dark beige
Screwdriver	
	Standard
G-fuse cartridge, 5 x 20 mm (IEC 60127-2)	
	0.25 A fast
	0.50 A fast
	1.00 A fast
	2.00 A fast
Marking tags	

Type	Qty.	Order No.
ZQV 6/2 GE	41 A 60	1627850000
ZQV 6/4 GE	41 A 60	1627870000
ZAP/TW 3	50	1608800000
ZAP TNHE/ZSI2.5	25	1610840000
SDIS SLIM 0.6X3.5X100	1	2749610000
G 20/0.25A/F	0.25 A 10	0430500000
G 20/0.50A/F	0.5 A 10	0430600000
G 20/1.00A/F	1 A 10	0430700000
G 20/2.00A/F	2 A 10	0430900000
DEK 5/5 MC NE WS	1000	1609801044
WS 10/5 MC NE WS	720	1635000000

For detailed information on other accessories and application in the online catalogue

ZSI 2.5 LED

2.5 mm²

For metric fuses 5 x 20 mm



Width/Height/Depth	mm
max. current / max. cond. cross-section	A/mm ²
Max. clamping range	mm ²

7.9 x 79.5 x 73
6.3 / 4
0.13...4

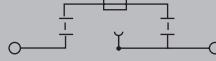

Technical data

Rated data	
Rated voltage to adjoining terminal	V
Rated current	A
for wire cross-section	mm ²
Rated impulse withstand voltage / Pollution severity	
UL 94 flammability rating	
Approvals	
Clamped conductors (H05V/H07V)	
Solid / Stranded	mm ²
Flexible / Flexible with ferrule	mm ²
Blade size	
Note	

IEC 60947-7-3

IEC	UL	CSA	EN 60079-7
500			
6.3			
2.5	AWG 26...12	AWG 26...12	
6 kV / 3			
V-0			
Rated connection			
0.5...4			
0.5...4 / 0.5...2.5			
0.6 x 3.5 mm			
Max. power loss (1.6 W) at the cartridge fuse limits the rated current.			

Ordering data

Version	
	500 V AC/DC, without LED
	10-36 V AC/DC, with LED
	30-70 V AC/DC, with LED
	60-150 V AC/DC, with LED
	140-250 V AC/DC, with LED
Note	

Accessories

Plug-in cross-connection	
	2-pole
	4-pole
End plate / Partition plate	
	dark beige
	dark beige
Screwdriver	
	Standard
G-fuse cartridge, 5 x 20 mm (IEC 60127-2)	
	0.25 A fast
	0.50 A fast
	1.00 A fast
	2.00 A fast
G25 with indicator / imperial (inch) fuse	
	0.50 A medium slow / 2 A
	1.00 A medium slow / 3 A
	2.00 A fast / 5 A
	4.00 A fast / 10 A
Marking tags	

Type	Qty.	Order No.
ZSI 2.5/LD 28AC	50	1616440000
ZSI 2.5/LD 60AC	50	1616430000
ZSI 2.5/LD 120AC	50	1616420000
ZSI 2.5/LD 250AC	50	1616410000
The rated voltage for cartridge fuse holders is 250 V and the rated impulse voltage 4 kV.		

Type	Qty.	Order No.
ZQV 6/2 GE	41 A 60	1627850000
ZQV 6/4 GE	41 A 60	1627870000
ZAP/TW 3	50	1608800000
ZAP TNHE/ZSI2.5	25	1610840000
SDIS SLIM 0.6X3.5X100	1	2749610000
G 20/0.25A/F	0.25 A 10	0430500000
G 20/0.50A/F	0.5 A 10	0430600000
G 20/1.00A/F	1 A 10	0430700000
G 20/2.00A/F	2 A 10	0430900000
DEK 5/5 MC NE WS	1000	1609801044
WS 10/5 MC NE WS	720	1635000000

ZSI 2.5/5x25

2.5 mm²

For metric fuses 5 x 25 mm

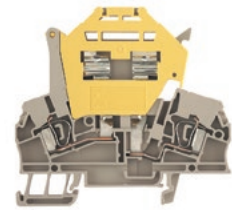

Width/Height/Depth	mm
max. current / max. cond. cross-section	A/mm ²
Max. clamping range	mm ²

7.9 x 79.5 x 73
6.3 / 4
0.13...4



IEC 60947-7-3

IEC	UL	CSA	EN 60079-7
500			
6.3			
2.5			
6 kV / 3			
V-0			
Rated connection			
0.5...4			
0.5...4			
0.6 x 3.5 mm			
Max. power loss (1.6 W) at the cartridge fuse limits the rated current.			

Type	Qty.	Order No.
ZSI 2.5/5X25	50	1730900000
The rated voltage for cartridge fuse holders is 250 V and the rated impulse voltage 4 kV.		

Type	Qty.	Order No.
ZQV 6/2 GE	41 A 60	1627850000
ZQV 6/4 GE	41 A 60	1627870000
ZAP/TW 3	50	1608800000
ZAP TNHE/ZSI2.5	25	1610840000
SDIS SLIM 0.6X3.5X100	1	2749610000
G 25/0.50A/M WS	0.5 A 10	0510300000
G 25/1.00A/M RT	1 A 10	0265800000
G 25/2.00A/F BL	2 A 10	0192700000
G 25/4.00A/F BR	4 A 10	0192800000
DEK 5/5 MC NE WS	1000	1609801044
WS 10/5 MC NE WS	720	1635000000

For detailed information on other accessories and application in the online catalogue

Status display using a bi-directional LED.

Spring connection with tension clamp technology (Z-Series)

Fuse terminal blocks

ZSI 2.5/2

2.5 mm²

For imperial fuses

ZSI 2.5/2

Overload and short-circuit protection



Width/Height/Depth	mm
max. current / max. cond. cross-section	A/mm ²
Max. clamping range	mm ²

11.9 x 79.5 x 73
12 / 4
0.13...4

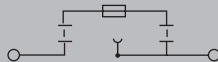

Technical data

Rated data	
Rated voltage to adjoining terminal	V
Rated current	A
for wire cross-section	mm ²
Rated impulse withstand voltage / Pollution severity	
UL 94 flammability rating	
Approvals	
Clamped conductors (H05V/H07V)	
Solid / Stranded	mm ²
Flexible / Flexible with ferrule	mm ²
Blade size	
Note	

IEC 60947-7-3

IEC	UL	CSA	EN 60079-7
500	600 (C)	600 (C)	
12	16	15	
2.5	AWG 26...12	AWG 26...12	
6 kV / 3			
V-0			

CE

Rated connection	
0.5...4	
0.5...4 / 0.5...2.5	
0.6 x 3.5 mm	
Note	
Max. power loss (1.6 W) at the cartridge fuse limits the rated current.	

Ordering data

Version	
	500 V AC/DC, without LED
Note	

Type	Qty.	Order No.
ZSI 2.5/2 500AC	10	1616460000
Note		
The rated voltage for cartridge fuse holders is 250 V and the rated impulse voltage 4 kV.		

Accessories

Plug-in cross-connection	
	2-pole
	4-pole
End plate / Partition plate	
	dark beige
Screwdriver	
	Standard
Marking tags	

Type	Qty.	Order No.
ZQS 2.5/2	24 A 20	1633200000
ZQS 2.5/4	24 A 20	1633220000
ZAP TNHE/ZSI2.5	25	1610840000
SDIS SLIM 0.6X3.5X100	1	2749610000
DEK 5/5 MC NE WS	1000	1609801044
WS 10/5 MC NE WS	720	1635000000

Type	Order No.
ZSI 2.5/2 500AC	1616460000

Arrangement	Applications			
	Only short-circuit protection		Overload and short-circuit protection	
	T _A max.	Nominal values	T _A max.	Nominal values
Individual	46 °C	4.0 W / 10.0 A	40 °C	2.5 W / 2.5 A
In combination	72 °C	2.5 W / 2.5 A	29 °C	2.5 W / 2.5 A

For detailed information on other accessories and application in the online catalogue

Status display using a bi-directional LED. With use of inch fuse cartridges.

Spring connection with tension clamp technology (Z-Series)

Fuse terminal blocks

ZSI 2.5 2x2 AN

2.5 mm²

For metric fuses 5 x 20



ZSI 2.5 2x2 AN

2.5 mm²

For metric fuses 5 x 25



Width/Height/Depth	mm
max. current / max. cond. cross-section	A/mm ²
Max. clamping range	mm ²

12.2 x 68 x 55	
10 / 4	
0.13...4	

12.2 x 68 x 55	
10 / 4	
0.13...4	

Technical data

Rated data	
Rated voltage to adjoining terminal	V
Rated current	A
for wire cross-section	mm ²
Rated impulse withstand voltage / Pollution severity	
UL 94 flammability rating	
Approvals	
Clamped conductors (H05V/H07V)	
Solid / Stranded	mm ²
Flexible / Flexible with ferrule	mm ²
Blade size	
Note	

IEC 60947-7-3

IEC	UL	CSA	EN 60079-7
500	300 (C)	300 (C)	
10	10	10	
2.5	AWG 26...12	AWG 26...12	
4 kV / 3			
V-0			

CE

Rated connection	
Solid / Stranded	mm ²
Flexible / Flexible with ferrule	mm ²
Blade size	

Note

IEC 60947-7-3

IEC	UL	CSA	EN 60079-7
500	300 (C)	300 (C)	
10	10	10	
2.5	AWG 26...12	AWG 26...12	
4 kV / 3			
V-0			

CE

Rated connection	
Solid / Stranded	mm ²
Flexible / Flexible with ferrule	mm ²
Blade size	

Note

Ordering data

Version	
	500 V AC/DC, without LED
Note	

Type	Qty.	Order No.
ZSI 2.5-2/2X2AN/G20	20	1826050000
Note		

Type	Qty.	Order No.
ZSI 2.5-2/2X2AN/G25	20	1826200000
Note		

Accessories

Plug-in cross-connection	
	2-pole
End plate / Partition plate	End plate, Wemid
Screwdriver	Standard
G-fuse cartridge, 5 x 20 mm (IEC 60127-2)	
	0.25 A fast
	0.50 A fast
	1.00 A fast
	2.00 A fast
Marking tags	
G25 with indicator / imperial (inch) fuse	
	0.50 A medium slow / 2 A
	1.00 A medium slow / 3 A
	2.00 A fast / 5 A
	4.00 A fast / 10 A

Type	Qty.	Order No.
ZQV 4/2 GE	32 A 60	1608950000
ZAP ZDU6-2 SW	50	1814710000
SDIS SLIM 0.6X3.5X100	1	2749610000
G 20/0.25A/F	0.25 A 10	0430500000
G 20/0.50A/F	0.5 A 10	0430600000
G 20/1.00A/F	1 A 10	0430700000
G 20/2.00A/F	2 A 10	0430900000
DEK 5/5 MC NE WS	1000	1609801044
WS 10/5 MC NE WS	720	1635000000
Note		

Type	Qty.	Order No.
ZQV 4/2 GE	32 A 60	1608950000
ZAP ZDU6-2 SW	50	1814710000
SDS 0.6X3.5X100	1	2749340000
WS 10/5 MC NE WS	720	1635000000
G 25/0.50A/M WS	0.5 A 10	0510300000
G 25/1.00A/M RT	1 A 10	0265800000
G 25/2.00A/F BL	2 A 10	0192700000
G 25/4.00A/F BR	4 A 10	0192800000
Note		

For detailed information on other accessories and application in the online catalogue

ZSI 2.5-2

Overload and short-circuit protection

ZSI 2.5-2 / G20

Type	Order No.
ZSI 2.5-2/2X2AN/G20	1826050000

Arrangement	Applications			
	Only short-circuit protection		Overload and short-circuit protection	
	T _a max.	Nominal values	T _a max.	Nominal values
Individual			39 °C	2.5 W / 6.3 A
In combination			41 °C	1.6 W / 6.3 A

ZSI 2.5-2 / G25

Type	Order No.
ZSI 2.5-2/2X2AN/G25	1826200000

Arrangement	Applications			
	Only short-circuit protection		Overload and short-circuit protection	
	T _a max.	Nominal values	T _a max.	Nominal values
Individual	60 °C			
In combination	47 °C			



Spring connection with tension clamp technology (Z-Series)

Fuse terminal blocks

ZSI 2.5 2x2 AN LED

2.5 mm²

For metric fuses 5 x 20



Width/Height/Depth	mm
max. current / max. cond. cross-section	A/mm ²
Max. clamping range	mm ²

12.2 x 68 x 55

10 / 4

0.13...4

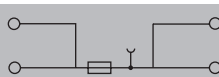

Technical data

Rated data	
Rated voltage to adjoining terminal	V
Rated current	A
for wire cross-section	mm ²
Rated impulse withstand voltage / Pollution severity	
UL 94 flammability rating	
Approvals	
Clamped conductors (H05V/H07V)	
Solid / Stranded	mm ²
Flexible / Flexible with ferrule	mm ²
Blade size	

IEC 60947-7-3

IEC	UL	CSA	EN 60079-7
500	300 (C)		
10	10		
2.5	AWG 26...12	AWG 26...12	
			4 kV / 3
			V-0

CE

Rated connection

0.5...4
0.5...4 / 0.5...2.5
0.6 x 3.5 mm

Note

Ordering data

Version	
	10-36 V AC/DC, with LED
	60-150 V AC/DC, with LED
	140-250 V AC/DC, with LED

Note

Type	Qty.	Order No.
ZSI 2.5-2/2X2AN/G20/LD1	20	1867440000
ZSI 2.5-2/2X2AN/G20/LD3	20	1867420000
ZSI 2.5-2/2X2AN/G20/LD4	20	1879730000

Accessories

Plug-in cross-connection	
	2-pole
End plate / Partition plate	
	End plate, Wemid
Screwdriver	
	Standard
G-fuse cartridge, 5 x 20 mm (IEC 60127-2)	
	0.25 A fast
	0.50 A fast
	1.00 A fast
	2.00 A fast
Marking tags	

Type	Qty.	Order No.
ZQV 4/2 GE	32 A 60	1608950000
ZAP ZDU6-2 SW	50	1814710000
SDIS SLIM 0.6X3.5X100	1	2749610000
G 20/0.25A/F	0.25 A 10	0430500000
G 20/0.50A/F	0.5 A 10	0430600000
G 20/1.00A/F	1 A 10	0430700000
G 20/2.00A/F	2 A 10	0430900000
DEK 5/5 MC NE WS	1000	1609801044
WS 10/5 MC NE WS	720	1635000000

For detailed information on other accessories and application in the online catalogue



ZSI 6-2 2x2.5

6 mm²

For metric fuses 5 x 20 / 5 x 25



ZSI 6-2 LED

6 mm²

For metric fuses 5 x 20



Width/Height/Depth	mm
max. current / max. cond. cross-section	A/mm ²
Max. clamping range	mm ²

12.2 x 68 x 55	
10 / 10	
0.13...10	

12.2 x 68 x 55	
10 / 10	
0.13...10	

Technical data

Rated data	
Rated voltage to adjoining terminal	V
Rated current	A
for wire cross-section	mm ²
Rated impulse withstand voltage / Pollution severity	
UL 94 flammability rating	
Approvals	
Clamped conductors (H05V/H07V)	
Solid / Stranded	mm ²
Flexible / Flexible with ferrule	mm ²
Blade size	
Note	

IEC 60947-7-3

IEC	UL	CSA	EN 60079-7
500	300 (C)	300 (C)	
10	10	10	
6	AWG 26...12	AWG 26...8	
4 kV / 3			
V-0			
CE			
Rated connection			
0.5...10		0.5...4	
0.5...10 / 0.5...6		0.5...4 / 0.5...2.5	
0.6 x 3.5 mm			
Note			

IEC 60947-7-3

IEC	UL	CSA	EN 60079-7
500	300 (C)		
10	10		
6	AWG 26...12	AWG 20...8	
4 kV / 3			
V-0			
CE			
Rated connection			
0.5...10		0.5...4	
0.5...10 / 0.5...6		0.5...4 / 0.5...2.5	
0.6 x 3.5 mm			
Note			

Ordering data

Version	
	500 V AC/DC, without LED
	10-36 V AC/DC, with LED
	140-250 V AC/DC, with LED
Note	

Type	Qty.	Order No.
ZSI 6-2 2X2.5/G25	20	1820950000
Note		

Type	Qty.	Order No.
ZSI 6-2 2X2.5/G20/LD1	20	1867500000
ZSI 6-2 2X2.5/G20/LD4	20	1879750000
Note		

Accessories

Plug-in cross-connection	2-pole
End plate / Partition plate	End plate, Wemid
Screwdriver	Standard
G-fuse cartridge, 5 x 20 mm (IEC 60127-2)	0.50 A fast 1.00 A fast 2.00 A fast 0.25 A fast
G25 with indicator / imperial (inch) fuse	2.00 A fast / 5 A 4.00 A fast / 10 A 1.00 A medium slow / 3 A 0.50 A medium slow / 2 A
Marking tags	

Type	Qty.	Order No.
ZQV 4/2 GE	32 A 60	1608950000
ZAP ZDU6-2 SW	50	1814710000
SDS 0.8X4.0X100	1	2749360000
G 20/0.50A/F	0.5 A 10	0430600000
G 20/1.00A/F	1 A 10	0430700000
G 20/2.00A/F	2 A 10	0430900000
G 20/0.25A/F	0.25 A 10	0430500000
G 25/2.00A/F BL	2 A 10	0192700000
G 25/4.00A/F BR	4 A 10	0192800000
G 25/1.00A/M RT	1 A 10	0265800000
G 25/0.50A/M WS	0.5 A 10	0510300000
DEK 5/5 MC NE WS	1000	1609801044
WS 10/5 MC NE WS	720	1635000000

Type	Qty.	Order No.
ZQV 4/2 GE	32 A 60	1608950000
ZAP ZDU6-2 SW	50	1814710000
SDIS SLIM 0.8X4.0X100	1	2749620000
G 20/0.50A/F	0.5 A 10	0430600000
G 20/1.00A/F	1 A 10	0430700000
G 20/2.00A/F	2 A 10	0430900000
G 20/0.25A/F	0.25 A 10	0430500000
DEK 5/5 MC NE WS	1000	1609801044
WS 10/5 MC NE WS	720	1635000000

For detailed information on other accessories and application in the online catalogue



Spring connection with tension clamp technology (Z-Series) Fuse terminal blocks

ZSI 6-2/FC

6 mm²

For car fuses



ZSI 6-2/FC

Overload and short-circuit protection

Width/Height/Depth	mm
max. current / max. cond. cross-section	A/mm ²
Max. clamping range	mm ²

8.1 x 70 x 50
30 / 10
0.33...10



Technical data

Rated data	
Rated voltage to adjoining terminal	V
Rated current	A
for wire cross-section	mm ²
Rated impulse withstand voltage / Pollution severity	
UL 94 flammability rating	
Approvals	
Clamped conductors (H05V/H07V)	
Solid / Stranded	mm ²
Flexible / Flexible with ferrule	mm ²
Blade size	
Note	

DIN 72581-3, IEC 60947-7-3

IEC	UL	CSA	EN 60079-7
250	300 (C)	300 (C)	
30	25	25	
6	AWG 22...10	AWG 22...10	
6 kV / 3			
V-0			

CE CB ENEC ETL KECH

Rated connection	
0.5...10	
0.5...10 / 0.5...6	
4.0 x 0.8 mm	
Note	
Fuse continuous current max. 80 % IN.	

Ordering data

Version	
	500 V AC/DC, without LED
	10-36 V AC/DC, with LED
Note	

Type	Qty.	Order No.
ZSI 6-2/FC	25	1814690000
ZSI 6-2/FC LD	25	1814700000

Accessories

Pluggable cross-connection	
	2-pole
	4-pole
End plate / Partition plate	
	End plate, Wemid
Screwdriver	
	Standard
Circuit breaker ETA and car fuses*	
Rated voltage	
Rated current	A
Switching capacity	A
Protection	IP
*) Note: not possible to order from Weidmüller	
Rated current circuit breaker	A

Type	current	Qty.	Order No.
ZQV 6/2 GE	41 A	60	1627850000
ZQV 6/4 GE	41 A	60	1627870000
ZAP ZDU6-2 SW		50	1814710000
SDIS SLIM 0.8X4.0X100		1	2749620000

Circuit breaker 1180	
65 V DC / 250 V AC	
0.1...10	
2000	
40	

Circuit breaker 1180			
	Order No.		Order No.
0.1	1278840000	2	1278970000
0.2	1278850000	2.5	1278980000
0.25	1278860000	3	1278990000
0.3	1278870000	3.5	1279010000
0.4	1278880000	4	1279020000
0.5	1278910000	5	1279030000
0.6	1278920000	6	1279040000
0.7	1278930000	7	1279050000
0.8	1278940000	8	1279060000
1	1278950000	10	1279070000
1.5	1278960000		

ETA 1180



Identification systems

DEK 5/6 MC NE WS	1000	1609820000
WS 12/6 MC NE WS	600	1609900000

DEK 5/6 MC NE WS	1000	1609820000
WS 12/6 MC NE WS	600	1609900000

For detailed information on other accessories and application in the online catalogue

Status display using a bi-directional LED. With use of Pudenz fuses.

Type	Order No.
ZSI 6-2/FC	1814690000

Arrangement	Applications			
	Only short-circuit protection		Overload	
	T _A max.	Nominal values	T _A max.	Nominal values
Individual	24 °C	3,0 W / 30 A	*	*
In combination	28 °C	1,90 W / 24 A (30 A)**	*	*

*) Values not available
 **) According to information from the manufacturer, the rated value of the fuse must be reduced to 80 % of the nominal value of the fuse. The permitted power loss is limited by the surface temperature of the fuse.
 => The 30 A fuse can be loaded to a maximum 24 A

Especially suitable for utility vehicles in combination with standard car fuses and thermal circuit breakers.

- Simple fuse protection for the plant or facility
- Simplifies the wiring by using ZQV cross-connections
- Simple distribution of potentials
- Vibration-proof
- Optimised wire insertion to connect short-circuit proof cables
- Pluggable solution for ETA circuit breaker (Typ 1170) or alternatively car fuses

ZSI 2x6/4x2.5 FC

6/2.5 mm²

Circuit breaker ETA 1170
28 V DC

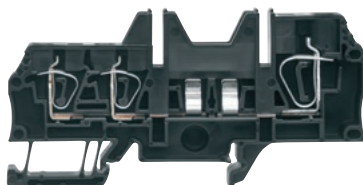

ZSI 2X6/4X2.5 FC / ZSI 2X6/4X2.5

Overload and short-circuit protection

Width/Length/Height with TS35x7.5	mm
Insulating stripping length	mm

16 / 93 / 47.5	
10	

Technical data

Rated data	
Rated voltage to adjoining terminal	V
Rated current	A
Rated cross-section	mm ²
Approvals	
Other technical data	
Clamped conductors	
solid H07V-U	mm ²
stranded H07V-K	mm ²
„f“ with ferrule acc. DIN 46 228/1	mm ²
„f“ ferrules with plastic collar	mm ²
max. clamping range in mm ²	
gauge acc. to IEC 60 947-1	Size

IEC	UL	CSA	EN 60079-7
500	600	600	
57	20	20	
2.5	AWG 26...12	AWG 26...12	
6	AWG 20...8	AWG 20...8	
CE			
Output	Input		
0.5...4	0.5...10		
0.5...4	0.5...10		
0.5...2.5	0.5...6		
0.5...2.5	0.5...6		
0.08...4	0.21...10		

Type	Order No.
ZSI 2X6/4X2.5 FC	1058520000

Arrangement	Applications			
	ETA fuse		Automotive fuse	
	T _A max.	Nominal values	T _A max.	Nominal values
Individual	24 °C	1.68 W / 20 A (25 A)*	45 °C	1.9 W / 24 A (30 A)**
In combination	24 °C	1.68 W / 20 A (25 A)*	35 °C	1.9 W / 24 A (30 A)**

*) ETA circuit breakers 1170
According to information from the manufacturer, the rated value of the fuse must be reduced to 80 % of the nominal value of the fuse. The permitted power loss is limited by the surface temperature of the fuse.
⇒ The 25 A fuse can be loaded to a maximum 20 A

**) Automotive fuses in accordance with DIN 41576
According to information from the manufacturer, the rated value of the fuse must be reduced to 80 % of the nominal value of the fuse. The permitted power loss is limited by the surface temperature of the fuse.
⇒ The 30 A fuse can be loaded to a maximum 24 A

Note

Ordering data

Type	Qty.	Order No.
ZSI 2x6/4x2.5 FC	10	1058520000

Note

Accessories

Pluggable cross-connection	
	2-pole
	3-pole
	4-pole
End plate / partition	
	ZAP black Wemid
Screwdriver	
	SD acc. to DIN 5264-A

Circuit breaker ETA and car fuses*

Rated voltage	
Rated current	A
Switching capacity	A
Protection	IP
Rated current circuit breaker	A

ETA 1170



Marking systems	
(see assortment in catalogue 7)	Marking tags

*) Note:
not possible to order from Weidmüller

Type	Current	Qty.	Order No.
ZQV 6/2 GE	41 A	60	1627850000

Type	Current	Qty.	Order No.
ZAP ZSI2x6/4x2.5		50	1059310000
SDIS SLIM 0.6X3.5X100		1	2749610000
SDIS SLIM 0.8X4.0X100		1	2749620000

Circuit breaker 1170			
12 V DC / 48 V DC			
3...25			
200			
40			

Circuit breaker 1170		
	Colour	Order No.
3	violet	1278730000
4	pink	1278740000
5	orange	1278750000
6	green	1278760000
7.5	brown	1278770000
8	yellow	1278780000
10	red	1278790000
15	blue	1278810000
20	yellow	1278820000
25	white	1278830000

DEK 5/5 MC

Spring connection with tension clamp technology (Z-Series)
Fuse terminal blocks

Especially suitable for utility vehicles in combination with standard car fuses and thermal circuit breakers.

- Simple fuse protection for the plant or facility
- Simplifies the wiring by using ZQV cross-connections
- Simple distribution of potentials
- Vibration-proof
- Optimised wire insertion to connect short-circuit proof cables
- Pluggable solution for ETA circuit breaker (Typ 1180)

ZSI 2x6/4x2.5

6/2.5 mm²

Circuit breaker ETA 1180
65 V DC / 250 V AC

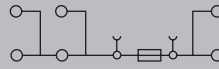
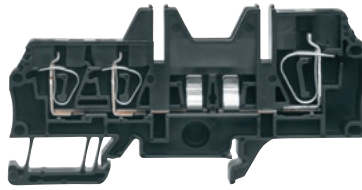

ZSI 2X6/4X2.5 FC / ZSI 2X6/4X2.5

Overload and short-circuit protection

Width/Length/Height with TS35x7.5	mm
Insulating stripping length	mm

Technical data

Rated data	
Rated voltage to adjoining terminal	V
Rated current	A
Rated cross-section	mm ²
Approvals	
Other technical data	
Clamped conductors	
solid H07V-U	mm ²
stranded H07V-K	mm ²
„f“ with ferrule acc. DIN 46 228/1	mm ²
„f“ ferrules with plastic collar	mm ²
max. clamping range in mm ²	
gauge acc. to IEC 60 947-1	Size

Note

Ordering data

Note

Accessories

Pluggable cross-connection	
	2-pole
	3-pole
	4-pole
End plate / partition	
	ZAP black Wemid
Screwdriver	
	SD acc. to DIN 5264-A

Circuit breaker ETA and car fuses*

Rated voltage	
Rated current	A
Switching capacity	A
Protection	IP
Rated current circuit breaker	A

ETA 1180



Marking systems	
	(see assortment in catalogue 7)
	Marking tags

***) Note:**
not possible to order from Weidmüller

IEC	UL	CSA	EN 60079-7
500	600	600	
57	20	20	
2.5	AWG 26...12	AWG 26...12	
6	AWG 20...8	AWG 20...8	
Output		Input	
0.5...4	0.5...10		
0.5...4	0.5...10		
0.5...2.5	0.5...6		
0.5...2.5	0.5...6		
0.08...4	0.21...10		

Type	Qty.	Order No.
ZSI 2x6/4x2.5	10	1265990000

Type	Strom	Qty.	Order No.
ZQV 6/2 GE	41 A	60	1627850000
ZAP ZSI2x6/4x2.5		50	1059310000
SDIS SLIM 0.6X3.5X100		1	2749610000
SDIS SLIM 0.8X4.0X100		1	2749620000

Circuit breaker 1180			
65 V DC / 250 V AC			
0.1...10			
2000			
40			

Circuit breaker 1180			
	Order No.		Order No.
0.1	1278840000	2	1278970000
0.2	1278850000	2.5	1278980000
0.25	1278860000	3	1278990000
0.3	1278870000	3.5	1279010000
0.4	1278880000	4	1279020000
0.5	1278910000	5	1279030000
0.6	1278920000	6	1279040000
0.7	1278930000	7	1279050000
0.8	1278940000	8	1279060000
1	1278950000	10	1279070000
1.5	1278960000		

DEK 5/5 MC

Type	Order No.
ZSI 2X6/4X2.5	1265990000

Arrangement	Applications	
	ETA fuse	
	T _A max.	Nominal values
Individual	24 °C	1.68 W / 20 A (25 A)*
In combination	24 °C	1.68 W / 20 A (25 A)*

***)** ETA circuit breakers 1180
 According to information from the manufacturer, the rated value of the fuse must be reduced to 80 % of the nominal value of the fuse. The permitted power loss is limited by the surface temperature of the fuse.
 => The 25 A fuse can be loaded to a maximum 20 A

Fuse cartridges and gauge rings for Weidmüller fuse terminal blocks

Fuse cartridges

for terminal type:
PSI 6/10
WSI 4
WSI 6
AFS 4 2C BK
PSI 6/10 SW
ZSI 2.5
ZSI 2.5-2/2X2AN/G20
ZSI 6-2 2X2.5/G20
KDKS 1/35 DB



Ordering data

G-type fuse cartridges 5 x 20 without indicator in accordance with IEC 60127-2 (VDE 0820 T.2 B1) ¹⁾						
Size (mm)	Rated current	Characteristics	Type	Qty.	Order No.	
	0.1	quick-acting	G 20/0.10A/F	10	0430300000	
	0.2	quick-acting	G 20/0.20A/F	10	0430400000	
Cartridge fuse	G-Si. 5 x 20	0.25	quick-acting	G 20/0.25A/F	10	0430500000
Rated breaking capacity	1.5 kA	0.5	quick-acting	G 20/0.50A/F	10	0430600000
	0.63	quick-acting	G 20/0.63A/F	10	0439000000	
	1	quick-acting	G 20/1.00A/F	10	0430700000	
	1.6	quick-acting	G 20/1.60A/F	10	0430800000	
	2	quick-acting	G 20/2.00A/F	10	0430900000	
	2.5	quick-acting	G 20/2.50A/F	10	0431000000	
	3.15	quick-acting	G 20/3.15A/F	10	0431100000	
	4	quick-acting	G 20/4.00A/F	10	0431200000	
	5	quick-acting	G 20/5.00A/F	10	0431300000	
	6.3	quick-acting	G 20/6.30A/F	10	0431400000	

(M) = medium time-lag; (F) = quick-acting

Fuse cartridges

for terminal type:
WSI 6



Ordering data

G-type fuse cartridges 5 x 25 with code in acc. with DIN 41576 ¹⁾						
Size (mm)	Rated current	Characteristics	Type	Qty.	Order No.	
	0.25	medium time-lag	G 25/0.25A/M GE	10	0546900000	
	0.5	medium time-lag	G 25/0.50A/M WS	10	0510300000	
Cartridge fuse	G-Si. 5 x 25	0.8	medium time-lag	G 25/0.80A/M GR	10	0646400000
Rated breaking capacity	80 A	1	medium time-lag	G 25/1.00A/M RT	10	0265800000
	2	quick-acting	G 25/2.00A/F BL	10	0192700000	
	4	quick-acting	G 25/4.00A/F BR	10	0192800000	
	6.3	quick-acting	G 25/6.30A/F GN	10	0192900000	
	10	medium time-lag	G 25/10.0A/M RT	10	0193100000	

(M) = medium time-lag; (F) = quick-acting

Fuse cartridges

for terminal type:
WSI 4/2
WSI 6/2 GZ/DEF63



Ordering data

Fuse cartridges 1¼" x ¼" without indicator in acc. with BS 88						
Size (mm)	Rated current	Characteristics	Type	Qty.	Order No.	
	0.5	quick-acting	GZ 0.5A/F	10	1460580000	
	1	quick-acting	GZ 1.0A/F	10	1460590000	
Cartridge fuse	G-Si. 6.3 x 32	2	quick-acting	GZ 2.0A/F	10	1460600000
Rated breaking capacity	50 kA	3	quick-acting	GZ 3.0A/F	10	1460610000
	5	quick-acting	GZ 5.0A/F	10	1460620000	
	7	quick-acting	GZ 7.0A/F	10	1460630000	
	10	quick-acting	GZ 10.0A/F	10	1460640000	
	12.5	quick-acting	GZ 12.5A/F	10	1460650000	

(M) = medium time-lag; (F) = quick-acting

Note: 1) The company SIBA supplies G-type cartridge fuses, 5 x 25 with indicator, also in marine engineering version for 450 V-.



Spring connection with tension clamp technology (Z-Series)

Test-disconnect terminal blocks

ZTR 2.5

2.5 mm²

Two connections

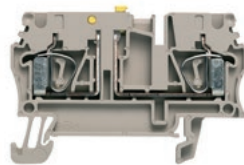

Width/Height/Depth	mm
max. current / max. cond. cross-section	A/mm ²
Max. clamping range	mm ²

5.1 x 59.5 x 38.5
20 / 4
0.05...4



Technical data

Rated data	
Rated voltage of feed-through terminal	V
Rated current	A
for wire cross-section	mm ²
Rated impulse withstand voltage / Pollution severity	
Gauge to IEC 60947-1 / UL 94 flammability rating	
Number of operating cycles	
Approvals	
Clamped conductors (H05V/H07V)	
Solid / Stranded	mm ²
Flexible / Flexible with ferrule	mm ²
Stripping length / Blade size	mm/-

Note

Ordering data

Version	
	dark beige
	Blue

Note

Accessories

Plug-in cross-connection	
	2-pole
	4-pole
	10-pole
End plate / Partition plate	
	dark beige
End bracket	
	dark beige
Screwdriver	
	Standard
Testing / Checking	
	Test plug
Holder for cartridge fuse 5 x 20 mm	
	400 V AC/DC, without LED
	10 - 36 V AC/DC, red LED
	140 - 250 V AC/DC, red LED
Module connector (max. 250 V)	
	without fittings
	with wire jumper
	With 1N4007 diode
Test adapter	
	Standard
	With spigot
Disconnect plug	
	removable, as replacement for release lever
Marking tags	

For detailed information on other accessories and application in the online catalogue

ZTR 2.5/3AN

2.5 mm²

Three connections

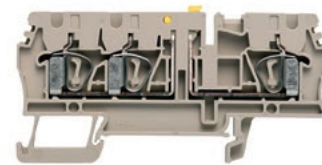

5.1 x 79.5 x 38.5
20 / 4
0.05...4



IEC 60947-7-1

IEC	UL	CSA	EN 60079-7
500	600	600	
20	20	20	
2.5	AWG 30...12	AWG 30...12	
6 kV / 3			
A3 / V-0			

CE

Rated connection	
	0.5...4 / 0.5...4
	0.5...4 / 0.5...2.5
	10 / 0.6 x 3.5 mm

Note

Type	Qty.	Order No.
ZTR 2.5/3AN	50	8731720000
ZTR 2.5/3AN BL	50	8731730000

IEC 60947-7-1

IEC	UL	CSA	EN 60079-7
500	600	600	
20	20	20	
2.5	AWG 30...12	AWG 30...12	
6 kV / 3			
A3 / V-0			

CE

Rated connection	
	0.5...4 / 0.5...4
	0.5...4 / 0.5...2.5
	10 / 0.6 x 3.5 mm

Note

Type	Qty.	Order No.
ZTR 2.5	50	1831280000
ZTR 2.5 BL	50	8731710000

Type	Qty.	Order No.
ZQV 2.5/2	24 A 60	1608860000
ZQV 2.5/10	24 A 20	1608940000
ZAP/TW 1	50	1608740000
ZEW 35	20	9540000000
SDIS SLIM 0.6X3.5X100	1	2749610000
PS 2.3 RT	20 mA 20	0180400000
SIHA 3/G20	6.3 A 25	7921560000
SIHA 3/G20/LD 10-36V	25	7921570000
SIHA 3/G20/LD 140-250V	25	7921600000
BEST	50	1833100000
BEST/DRBR	22 A 50	1878570000
BEST/D	1 A 50	1878560000
ZTA 1	9 A 25	1609040000
ZTA 1/ZA	9 A 25	1609050000
TNST	20 A 50	1833090000
DEK 5/5 MC NE WS	1000	1609801044
WS 10/5 MC NE WS	720	1635000000
DEK 5/5 MM WS	800	2007110000

For detailed information on other accessories and application in the online catalogue

Type	Qty.	Order No.
ZQV 2.5/2	24 A 60	1608860000
ZQV 2.5/10	24 A 20	1608940000
ZAP/TW 3	50	1608800000
ZEW 35	20	9540000000
SDIS SLIM 0.6X3.5X100	1	2749610000
PS 2.3 RT	20 mA 20	0180400000
SIHA 3/G20	6.3 A 25	7921560000
SIHA 3/G20/LD 10-36V	25	7921570000
SIHA 3/G20/LD 140-250V	25	7921600000
BEST	50	1833100000
BEST/DRBR	22 A 50	1878570000
BEST/D	1 A 50	1878560000
ZTA 1	9 A 25	1609040000
ZTA 1/ZA	9 A 25	1609050000
TNST	20 A 50	1833090000
DEK 5/5 MC NE WS	1000	1609801044
WS 10/5 MC NE WS	720	1635000000
DEK 5/5 MM WS	800	2007110000

For detailed information on other accessories and application in the online catalogue

ZTR 2.5/4AN

2.5 mm²

Four connections

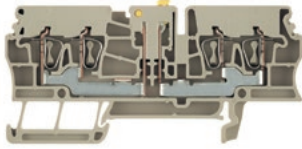

5.1 x 82.5 x 38.5
16 / 2.5
0.05...2.5



IEC 60947-7-1

IEC	UL	CSA	EN 60079-7
400	300	300	
16	10	10	
2.5	AWG 30...12	AWG 26...12	
6 kV / 3			
A2 / V-0			

CE

Rated connection

0.5...4 / 0.5...4
0.5...4 / 0.5...2.5
10 / 0.6 x 3.5 mm

Type	Qty.	Order No.
ZTR 2.5/4AN	50	7920900000
ZTR 2.5/4AN BL	50	7920930000

Type	Qty.	Order No.
ZQV 2.5/2	24 A 60	1608860000
ZQV 2.5/10	24 A 20	1608940000
ZAP/TW 3	50	1608800000
ZEW 35	20	9540000000
SDIS SLIM 0.6X3.5X100	1	2749610000
PS 2.3 RT	20 mA 20	0180400000
SIHA 3/G20	6.3 A 25	7921560000
SIHA 3/G20/LD 10-36V	25	7921570000
SIHA 3/G20/LD 140-250V	25	7921600000
BEST	50	1833100000
BEST/DRBR	22 A 50	1878570000
BEST/D	1 A 50	1878560000
TNST	20 A 50	1833090000
DEK 5/5 MC NE WS	1000	1609801044
WS 8/5 MM WS	800	2007150000
DEK 5/5 MM WS	800	2007110000

ZTR 2.5-2

2.5 mm²

Two connections



5.1 x 50.5 x 43.5
21 / 2.5
0.13...2.5



IEC 60947-7-1

IEC	UL	CSA	EN 60079-7
400	300	300	
10	10	10	
2.5	AWG 26...12	AWG 26...12	
6 kV / 3			
A2 / V-0			

CE

Rated connection

0.5...2.5
0.5...2.5 / 0.5...1.5
10 / 0.6 x 3.5 mm

Type	Qty.	Order No.
ZTR 2.5-2	50	1779010000
ZTR 2.5-2 BL	50	1779120000

Type	Qty.	Order No.
ZQV 2.5/2	24 A 60	1608860000
ZQV 2.5/10	24 A 20	1608940000
ZAP/TW7	50	1706110000
ZEW 35	20	9540000000
SDIS SLIM 0.6X3.5X100	1	2749610000
SIHA 3/G20	6.3 A 25	7921560000
SIHA 3/G20/LD 10-36V	25	7921570000
SIHA 3/G20/LD 140-250V	25	7921600000
BEST	50	1833100000
BEST/DRBR	22 A 50	1878570000
BEST/D	1 A 50	1878560000
TNST	20 A 50	1833090000
DEK 5/5 MC NE WS	1000	1609801044
WS 8/5 MM WS	800	2007150000
DEK 5/5 MM WS	800	2007110000

ZTR 6-2

6 mm²

Two connections

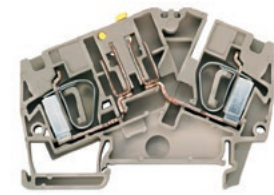

8.1 x 70 x 50
32 / 10
0.05...10

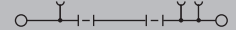

IEC 60947-7-1

IEC	UL	CSA	EN 60079-7
690	300		
32	25		
6	AWG 22...8		
8 kV / 3			
A5 / V-0			

CE

Rated connection

0.5...10 / 0.5...6
0.5...6 / 0.5...6
12 / 0.6 x 3.5 mm

Type	Qty.	Order No.
ZTR 6-2	50	1023830000

End plate (article: 1771440000 ZAP ZDU6-2) included.

Type	Qty.	Order No.
ZQV 6/2 GE	41 A 60	1627850000
ZQV 6/4 GE	41 A 60	1627870000
ZAP ZDU6-2	50	1771440000
ZEW 35	20	9540000000
SDIS 0.6X3.5X100	1	2749810000
SIHA 3/G20	6.3 A 25	7921560000
SIHA 3/G20/LD 10-36V	25	7921570000
SIHA 3/G20/LD 140-250V	25	7921600000
BEST	50	1833100000
BEST/DRBR	22 A 50	1878570000
BEST/D	1 A 50	1878560000
TNST	20 A 50	1833090000
DEK 5/8 MC NE WS	800	1856740000
WS 8/5 MM WS	800	2007150000
DEK 5/5 MM WS	800	2007110000



Spring connection with tension clamp technology (Z-Series)

Test-disconnect terminal blocks

ZDTR 2.5

2.5 mm²

Four connections

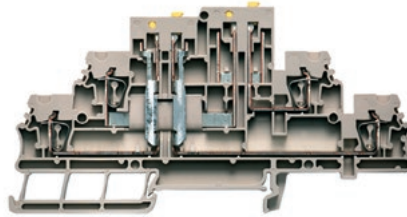

Width/Height/Depth	mm
max. current / max. cond. cross-section	A/mm ²
Max. clamping range	mm ²

5.1 x 117 x 67
16 / 4
0.13...4

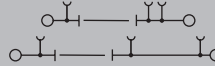

Technical data

Rated data	
Rated voltage of feed-through terminal	V
Rated current	A
for wire cross-section	mm ²
Rated impulse withstand voltage / Pollution severity	
Gauge to IEC 60947-1 / UL 94 flammability rating	
Number of operating cycles	
Approvals	
Clamped conductors (H05V/H07V)	
Solid / Stranded	mm ²
Flexible / Flexible with ferrule	mm ²
Stripping length / Blade size	mm/-

IEC 60947-7-1

IEC	UL	CSA	EN 60079-7
400	300	300	
16	10	10	
2.5	AWG 26...12	AWG 26...12	
6 kV / 3			
A2 / V-0			

CE

Rated connection	
0.5...4	
0.5...4 / 0.5...2.5	
10 / 0.6 x 3.5 mm	

Note

Ordering data

Version	
	dark beige
	Blue

Note

Type	Qty.	Order No.
ZDTR 2.5	20	1745400000
ZDTR 2.5 BL	20	1798330000

Accessories

Plug-in cross-connection	
	2-pole
	10-pole
End plate / Partition plate	
	dark beige
End bracket	
	dark beige
Screwdriver	
	Standard
Testing / Checking	
	Test plug
Marking tags	

Type	Qty.	Order No.
ZQV 2.5N/2	24 A 60	1527540000
ZQV 2.5N/10	24 A 20	1527690000
AP ZDTR2.5	20	1745420000
ZEW 35	20	9540000000
SDIS SLIM 0.6X3.5X100	1	2749610000
PS 2.3 RT	20 mA 20	0180400000
DEK 5/5 MC NE WS	1000	1609801044
DEK 5/5 MM WS	800	2007110000
WS 8/5 MM WS	800	2007150000

For detailed information on other accessories and application in the online catalogue



Spring connection with tension clamp technology (Z-Series)
Pluggable terminal blocks

Universal range

A

ZT 2.5/2AN/1

2.5 mm²

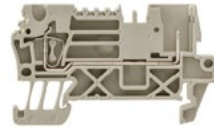

Width/Height/Depth	mm
max. current / max. cond. cross-section	A/mm ²
Max. clamping range	mm ²

5.1 x 58 x 34.5
24 / 4
0.13...4

Technical data

Rated data	
Rated voltage	V
Max. voltage of clamp support & pluggable system	V
Rated current	A
for wire cross-section	mm ²
Rated impulse withstand voltage / Pollution severity	
Gauge to IEC 60947-1 / UL 94 flammability rating	
Approvals	
Clamped conductors (H05V/H07V)	
Solid / Stranded	mm ²
Flexible / Flexible with ferrule	mm ²
Stripping length / Blade size	mm/-
Note	

Ordering data

	dark beige
	Blue
Plug-in connector	
Note	

Accessories

Plug-in cross-connection	
	2-pole
	10-pole
End plate / Partition plate	
	dark beige
	Orange
Test adapter	
	Standard
	With spigot
Miscellaneous accessories WeiCoS	
	Locking element
	Coding element
	Strain relief
Screwdriver	
	Standard
Marking tags	
For detailed information on other accessories and application in the online catalogue	

ZT 2.5/3AN/1

2.5 mm²

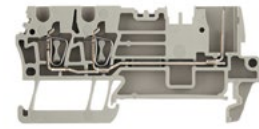

5.1 x 71.5 x 34.5
24 / 4
0.13...4

In accordance with IEC 60947-7-1

IEC	UL	CSA	EN 60079-7
500	300	300	
690			
24	20	20	
2.5	AWG 26...12		
	6 kV / 3		
	A2 / V-0		

CE, ENEC, KEMA, TÜV

Rated connection	Plug-in connection
0.5...4	
0.5...4 / 0.5...2.5	
10 / 0.6 x 3.5 mm	

Note

Type	Qty.	Order No.
ZT 2.5/3AN/1	50	1815090000
ZT 2.5/3AN/1 BL	50	1304720000
Type		
Type	Qty.	Order No.
ZP 2.5/1AN/QV/1	50	1815190000
ZP 2.5/1AN/QV/2	25	1815200000
ZP 2.5/1AN/QV/3	25	1815210000
ZP 2.5/1AN/QV/4	25	1815220000
ZP 2.5/1AN/QV/5	25	1815230000
ZP 2.5/1AN/QV/6	25	1815240000
ZP 2.5/1AN/QV/7	25	1815250000
ZP 2.5/1AN/QV/8	20	1815260000
ZP 2.5/1AN/QV/9	20	1815270000
ZP 2.5/1AN/QV/10	20	1815280000

Note

Type	Qty.	Order No.
ZT 2.5/2AN/1	50	1815070000
ZT 2.5/2AN/1 BL	50	1295550000
Type		
Type	Qty.	Order No.
ZP 2.5/1AN/QV/1	50	1815190000
ZP 2.5/1AN/QV/2	25	1815200000
ZP 2.5/1AN/QV/3	25	1815210000
ZP 2.5/1AN/QV/4	25	1815220000
ZP 2.5/1AN/QV/5	25	1815230000
ZP 2.5/1AN/QV/6	25	1815240000
ZP 2.5/1AN/QV/7	25	1815250000
ZP 2.5/1AN/QV/8	20	1815260000
ZP 2.5/1AN/QV/9	20	1815270000
ZP 2.5/1AN/QV/10	20	1815280000

Type	Qty.	Order No.
ZQV 2.5N/2	24 A 60	1527540000
ZQV 2.5N/10	24 A 20	1527690000
Type		
Type	Qty.	Order No.
ZAP/TW ZT2.5/2AN	50	1816030000
ZAP/TW ZT2.5/2AN OR	50	1816040000
Type		
Type	Qty.	Order No.
ZTA ZT2.5	17.5 A 25	1827080000
ZTA ZT2.5/ZA	17.5 A 25	1847600000
Type		
Type	Qty.	Order No.
ZVR ZP2.5	25	1816130000
KOSF ZT2.5	50	1816150000
ZZE ZP2.5	25	1816140000
Type		
Type	Qty.	Order No.
SDIS SLIM 0.6X3.5X100	1	2749610000
Type		
Type	Qty.	Order No.
DEK 5/6 MC NE WS	1000	1609820000
WS 10/5 MC M SDR	144	1792010000
DEK 5/5 MM WS	800	2007110000

Type	Qty.	Order No.
ZQV 2.5N/2	24 A 60	1527540000
ZQV 2.5N/10	24 A 20	1527690000
Type		
Type	Qty.	Order No.
ZAP/TW ZT2.5/3AN	50	1816050000
Type		
Type	Qty.	Order No.
ZTA ZT2.5	17.5 A 25	1827080000
ZTA ZT2.5/ZA	17.5 A 25	1847600000
Type		
Type	Qty.	Order No.
ZVR ZP2.5	25	1816130000
KOSF ZT2.5	50	1816150000
ZZE ZP2.5	25	1816140000
Type		
Type	Qty.	Order No.
SDIS SLIM 0.6X3.5X100	1	2749610000
Type		
Type	Qty.	Order No.
DEK 5/5 MC NE WS	1000	1609801044
WS 10/5 MC M SDR	144	1792010000
DEK 5/5 MM WS	800	2007110000

ZT 2.5/4AN/2

2.5 mm²

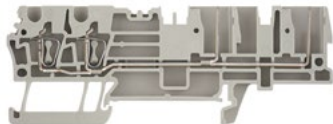

5.1 x 93 x 34.5
24 / 4
0.13...4



In accordance with IEC 60947-7-1

IEC	UL	CSA	EN 60079-7
500	300	300	
690			
24	20	20	
2.5	AWG 26...12		
			6 kV / 3
			A2 / V-0



Rated connection Plug-in connection

0.5...4
0.5...4 / 0.5...2.5
10 / 0.6 x 3.5 mm

ZT 2.5/4AN/4

2.5 mm²



5.1 x 85.5 x 34.5
24 / 4
0.13...4



In accordance with IEC 60947-7-1

IEC	UL	CSA	EN 60079-7
500	300	300	
690			
24	20	20	
2.5	AWG 26...12		
			6 kV / 3
			/V-0



Rated connection Plug-in connection

Type	Qty.	Order No.
ZT 2.5/4AN/2	50	1815110000

Type	Qty.	Order No.
ZP 2.5/1AN/QV/1	50	1815190000
ZP 2.5/1AN/QV/2	25	1815200000
ZP 2.5/1AN/QV/3	25	1815210000
ZP 2.5/1AN/QV/4	25	1815220000
ZP 2.5/1AN/QV/5	25	1815230000
ZP 2.5/1AN/QV/6	25	1815240000
ZP 2.5/1AN/QV/7	25	1815250000
ZP 2.5/1AN/QV/8	20	1815260000
ZP 2.5/1AN/QV/9	20	1815270000
ZP 2.5/1AN/QV/10	20	1815280000

Type	Qty.	Order No.
ZQV 2.5N/2	24 A 60	1527540000
ZQV 2.5N/10	24 A 20	1527690000

ZAP/TW ZT2.5/4AN/2	50	1816070000
ZAP/TW ZT2.5/4AN/2 OR	50	1816080000

ZTA ZT2.5	17.5 A 25	1827080000
ZTA ZT2.5/ZA	17.5 A 25	1847600000

ZVR ZP2.5	25	1816130000
KOSF ZT2.5	50	1816150000
ZZE ZP2.5	25	1816140000

SDIS SLIM 0.6X3.5X100	1	2749610000
-----------------------	---	------------

DEK 5/5 MC NE WS	1000	1609801044
WS 10/5 MC M SDR	144	1792010000
DEK 5/5 MM WS	800	2007110000

Type	Qty.	Order No.
ZT 2.5/4AN/4	50	1815130000

Type	Qty.	Order No.
ZP 2.5/1AN/1	50	1815430000
ZP 2.5/1AN/2	25	1815440000
ZP 2.5/1AN/3	25	1815450000
ZP 2.5/1AN/4	25	1815500000
ZP 2.5/1AN/5	25	1815510000
ZP 2.5/1AN/6	25	1815520000
ZP 2.5/1AN/7	25	1815530000
ZP 2.5/1AN/8	20	1815540000
ZP 2.5/1AN/9	20	1815550000
ZP 2.5/1AN/10	20	1815560000

Type	Qty.	Order No.
ZQV 2.5N/2	24 A 60	1527540000
ZQV 2.5N/10	24 A 20	1527690000

ZAP/TW ZT2.5/4AN/4	50	1816090000
--------------------	----	------------

ZTA ZT2.5	17.5 A 25	1827080000
ZTA ZT2.5/ZA	17.5 A 25	1847600000

ZVR ZP2.5	25	1816130000
KOSF ZT2.5	50	1816150000
ZZE ZP2.5	25	1816140000

SDIS SLIM 0.6X3.5X100	1	2749610000
-----------------------	---	------------

DEK 5/5 MC NE WS	1000	1609801044
WS 8/5 MM WS	800	2007150000
DEK 5/5 MM WS	800	2007110000



Spring connection with tension clamp technology (Z-Series)

Pluggable terminal blocks

ZT 4/2AN/1

4 mm²

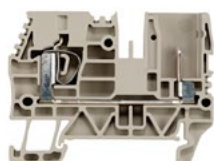

ZT 4/4AN/2

4 mm²

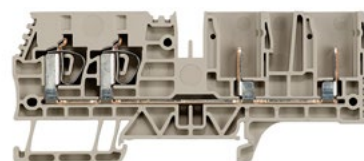

Width/Height/Depth	mm
max. current / max. cond. cross-section	A/mm ²
Max. clamping range	mm ²

6.5 x 58 x 43
32 / 6
0.13...6

6.5 x 100.5 x 43
32 / 6
0.13...6

Technical data

Rated data	
Rated voltage	V
Max. voltage of clamp support & pluggable system	V
Rated current	A
for wire cross-section	mm ²
Rated impulse withstand voltage / Pollution severity	
Gauge to IEC 60947-1 / UL 94 flammability rating	
Approvals	
Clamped conductors (H05V/H07V)	
Solid / Stranded	mm ²
Flexible / Flexible with ferrule	mm ²
Stripping length / Blade size	mm/-

In accordance with IEC 60947-1

IEC	UL	CSA	EN 60079-7
800	600	600	
800			
32	28	28	
4	AWG 26...10	AWG 26...10	
	8 kV / 3		
	A3 / V-0		

In accordance with IEC 60947-1

IEC	UL	CSA	EN 60079-7
800	600	600	
800			
32	28	28	
4	AWG 26...10	AWG 26...10	
	8 kV / 3		
	A3 / V-0		

CE

Rated connection	Plug-in connection
0.5...6	
0.5...6 / 0.5...4	
12 / 0.6 x 3.5 mm	

CE

Rated connection	Plug-in connection
0.5...6	
0.5...6 / 0.5...4	
12 / 0.6 x 3.5 mm	

Note

Ordering data

	dark beige
	Blue
Plug-in connector	

Type	Qty.	Order No.
ZT 4/2AN/1	50	1854960000
ZT 4/2AN/1 BL	50	1312830000

Type	Qty.	Order No.
ZT 4/4AN/2	50	1848350000

Type	Qty.	Order No.
ZP 4/1AN/1	50	1848340000
ZP 4/1AN/2	25	1854990000
ZP 4/1AN/3	25	1855000000
ZP 4/1AN/4	25	1855010000
ZP 4/1AN/5	20	1855020000
ZP 4/1AN/6	20	1855030000
ZP 4/1AN/7	20	1855040000
ZP 4/1AN/8	20	1855050000
ZP 4/1AN/9	10	1855060000
ZP 4/1AN/10	10	1855070000

Type	Qty.	Order No.
ZP 4/1AN/1	50	1848340000
ZP 4/1AN/2	25	1854990000
ZP 4/1AN/3	25	1855000000
ZP 4/1AN/4	25	1855010000
ZP 4/1AN/5	20	1855020000
ZP 4/1AN/6	20	1855030000
ZP 4/1AN/7	20	1855040000
ZP 4/1AN/8	20	1855050000
ZP 4/1AN/9	10	1855060000
ZP 4/1AN/10	10	1855070000

Note

Accessories

Plug-in cross-connection	
	2-pole
End plate / Partition plate	
	dark beige
	Orange
Miscellaneous accessories WeiCoS	
	Locking element
	Coding element
	Strain relief
Screwdriver	
	Standard
Marking tags	

Type	Qty.	Order No.
ZQV 4/2 GE	32 A 60	1608950000
ZAP/TW ZT4/2AN	50	1855220000
ZAP/TW ZT4/2AN OR	50	1855230000
ZVR ZP4	25	1855250000
KOSF ZT4	50	1856860000
ZZE ZP4	25	1855260000
SDIS SLIM 0.6X3.5X100	1	2749610000
DEK 5/6 MC NE WS	1000	1609820000
WS 10/6 MC NE WS	600	1828450000
DEK 5/6 MM WS	600	2007120000

Type	Qty.	Order No.
ZQV 4/2 GE	32 A 60	1608950000
ZAP/TW ZT4/4AN/2	50	1848360000
ZVR ZP4	25	1855250000
KOSF ZT4	50	1856860000
ZZE ZP4	25	1855260000
SDIS SLIM 0.6X3.5X100	1	2749610000
DEK 5/6 MC NE WS	1000	1609820000
WS 10/6 MC NE WS	600	1828450000
DEK 5/6 MM WS	600	2007120000

For detailed information on other accessories and application in the online catalogue

For detailed information on other accessories and application in the online catalogue

ZTPE 2.5/2AN/1

2.5 mm²

ZTPE 2.5/3AN/1

2.5 mm²

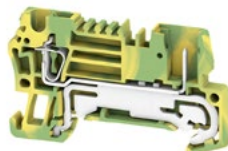

Width/Height/Depth	mm
max. current / max. cond. cross-section	-/mm ²
Max. clamping range	mm ²

5.1 x 58 x 34.5	
/ 4	
0.13...4	

5.1 x 71.5 x 34.5	
/ 4	
0.13...4	

Technical data

Rated data	
Rated voltage	V
Max. voltage of clamp support & pluggable system	V
Rated short-time current	
for wire cross-section	mm ²
Rated impulse withstand voltage / Pollution severity	
Gauge to IEC 60947-1 / UL 94 flammability rating	
Approvals	
Clamped conductors (H05V/H07V)	
Solid / Stranded	mm ²
Flexible / Flexible with ferrule	mm ²
Stripping length / Blade size	mm/-

In accordance with IEC 60947-7-2

IEC	UL	CSA	EN 60079-7
500		300	
690			
300 (2.5 mm ²)			
2.5	AWG 26...12		
		/ 3	
		A2 / V-0	

Rated connection	Plug-in connection
0.5...4	
0.5...4 / 0.5...2.5	
10 / 0.6 x 3.5 mm	

In accordance with IEC 60947-7-2

IEC	UL	CSA	EN 60079-7
500		300	
690			
300 (2.5 mm ²)			
2.5	AWG 26...12		
		/ 3	
		A2 / V-0	

Rated connection	Plug-in connection
0.5...4	
0.5...4 / 0.5...2.5	
10 / 0.6 x 3.5 mm	

Note

Ordering data

Version	Green/yellow
Note	

Type	Qty.	Order No.
ZTPE 2.5/2AN/1	50	1815080000

Type	Qty.	Order No.
ZTPE 2.5/3AN/1	50	1815100000

Accessories

End plate / Partition plate	
	dark beige
	Orange
Test adapter	
	Standard
	With spigot
Miscellaneous accessories WeiCoS	
	Locking element
	Coding element
	Strain relief
Screwdriver	
	Standard
Marking tags	

Type	Qty.	Order No.	
ZAP/TW ZT2.5/2AN	50	1816030000	
ZAP/TW ZT2.5/2AN OR	50	1816040000	
ZTA ZT2.5	17.5 A	25	1827080000
ZTA ZT2.5/ZA	17.5 A	25	1847600000
ZVR ZP2.5	25	1816130000	
KOSF ZT2.5	50	1816150000	
ZZE ZP2.5	25	1816140000	
SDIS SLIM 0.6X3.5X100	1	2749610000	
DEK 5/5 MC NE WS	1000	1609801044	
WS 10/5 MC NE WS	720	1635000000	
DEK 5/5 MM WS	800	2007110000	

Type	Qty.	Order No.	
ZAP/TW ZT2.5/3AN	50	1816050000	
ZTA ZT2.5	17.5 A	25	1827080000
ZTA ZT2.5/ZA	17.5 A	25	1847600000
ZVR ZP2.5	25	1816130000	
KOSF ZT2.5	50	1816150000	
ZZE ZP2.5	25	1816140000	
SDIS SLIM 0.6X3.5X100	1	2749610000	
DEK 5/5 MC NE WS	1000	1609801044	
WS 10/5 MC NE WS	720	1635000000	
DEK 5/5 MM WS	800	2007110000	

For detailed information on other accessories and application in the online catalogue



Spring connection with tension clamp technology (Z-Series)
Pluggable terminal blocks

Universal range

A

ZTPE 2.5/4AN/2

2.5 mm²

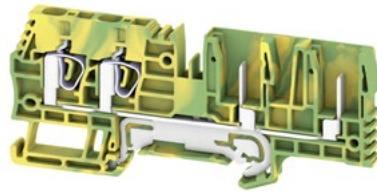

ZTPE 2.5/4AN/4

2.5 mm²



Width/Height/Depth	mm
max. current / max. cond. cross-section	-/mm ²
Max. clamping range	mm ²

5.1 x 93 x 34.5	/ 4	
0.13...4		

5.1 x 85.5 x 34.5	/ 4	
0.13...4		

Technical data

Rated data	
Rated voltage	V
Max. voltage of clamp support & pluggable system	V
Rated short-time current	
for wire cross-section	mm ²
Rated impulse withstand voltage / Pollution severity	
Gauge to IEC 60947-1 / UL 94 flammability rating	
Approvals	
Clamped conductors (H05V/H07V)	
Solid / Stranded	mm ²
Flexible / Flexible with ferrule	mm ²
Stripping length / Blade size	mm/-
Note	

In accordance with IEC 60947-7-2

IEC	UL	CSA	EN 60079-7
500		300	
690			
300 (2.5 mm ²)			
2.5	AWG 26...12		
	/ 3		
	A2 / V-0		

Rated connection	Plug-in connection
0.5...4	
0.5...4 / 0.5...2.5	
10 / 0.6 x 3.5 mm	

In accordance with IEC 60947-7-2

IEC	UL	CSA	EN 60079-7
500		300	
690			
300 (2.5 mm ²)			
2.5	AWG 26...12		
	/ 3		
	A2 / V-0		

Rated connection	Plug-in connection
0.5...4	
0.5...4 / 0.5...2.5	
10 / 0.6 x 3.5 mm	

Ordering data

Version	Green/yellow
Note	

Type	Qty.	Order No.
ZTPE 2.5/4AN/2	50	1815120000

Type	Qty.	Order No.
ZTPE 2.5/4AN/4	50	1815140000

Accessories

End plate / Partition plate	
	dark beige
	Orange
Test adapter	
	Standard
	With spigot
Miscellaneous accessories WeiCoS	
	Locking element
	Coding element
	Strain relief
Screwdriver	
	Standard
Marking tags	

Type	Qty.	Order No.
ZAP/TW ZT2.5/4AN/2	50	1816070000
ZAP/TW ZT2.5/4AN/2 OR	50	1816080000
ZTA ZT2.5	17.5 A 25	1827080000
ZTA ZT2.5/ZA	17.5 A 25	1847600000
ZVR ZP2.5	25	1816130000
KOSF ZT2.5	50	1816150000
ZZE ZP2.5	25	1816140000
SDIS SLIM 0.6X3.5X100	1	2749610000
DEK 5/5 MC NE WS	1000	1609801044
WS 10/5 MC NE WS	720	1635000000
DEK 5/5 MM WS	800	2007110000

Type	Qty.	Order No.
ZAP/TW ZT2.5/4AN/4	50	1816090000
ZTA ZT2.5	17.5 A 25	1827080000
ZTA ZT2.5/ZA	17.5 A 25	1847600000
ZVR ZP2.5	25	1816130000
KOSF ZT2.5	50	1816150000
ZZE ZP2.5	25	1816140000
SDIS SLIM 0.6X3.5X100	1	2749610000
DEK 5/5 MC NE WS	1000	1609801044
WS 10/5 MC NE WS	720	1635000000
DEK 5/5 MM WS	800	2007110000

For detailed information on other accessories and application in the online catalogue

ZTPE 4/2AN/1

4 mm²

ZTPE 4/4AN/2

4 mm²

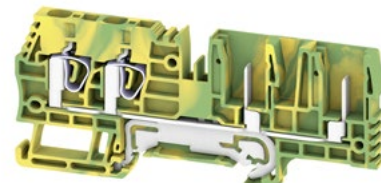

Width/Height/Depth	mm
max. current / max. cond. cross-section	-/mm ²
Max. clamping range	mm ²

6.5 x 58 x 43
/ 6
0.13...6

6.5 x 100.5 x 43
/ 6
0.13...6

Technical data

Rated data	
Rated voltage	V
Max. voltage of clamp support & pluggable system	V
Rated short-time current	
for wire cross-section	mm ²
Rated impulse withstand voltage / Pollution severity	
Gauge to IEC 60947-1 / UL 94 flammability rating	
Approvals	
Clamped conductors (H05V/H07V)	
Solid / Stranded	mm ²
Flexible / Flexible with ferrule	mm ²
Stripping length / Blade size	mm/-

In accordance with IEC 60947-7-2

IEC	UL	CSA	EN 60079-7
500			
800			
480 (4 mm ²)			
4	AWG 26...10	AWG 26...10	
		/ 3	
		A3 / V-0	

CE

Rated connection	Plug-in connection
0.5...6	
0.5...6 / 0.5...4	
12 / 0.6 x 3.5 mm	

In accordance with IEC 60947-7-2

IEC	UL	CSA	EN 60079-7
500			
800			
480 (4 mm ²)			
4	AWG 26...10	AWG 26...10	
		/ 3	
		A3 / V-0	

CE

Rated connection	Plug-in connection
0.5...6	
0.5...6 / 0.5...4	
12 / 0.6 x 3.5 mm	

Note

Ordering data

Version	Green/yellow
Note	

Type	Qty.	Order No.
ZTPE 4/2AN/1	50	1854970000

Type	Qty.	Order No.
ZTPE 4/4AN/2	50	1848330000

Accessories

End plate / Partition plate	
	dark beige
	Orange
Test adapter	
	Standard
Miscellaneous accessories WeiCoS	
	Locking element
	Coding element
	Strain relief
Screwdriver	
	Standard
Marking tags	
DIN A4 sheets	
	Paper
Protective strip	

Type	Qty.	Order No.	
ZAP/TW ZT4/2AN	50	1855220000	
ZAP/TW ZT4/2AN OR	50	1855230000	
ZTA ZT2.5	17.5 A	25	1827080000
ZVR ZP4	25	1855250000	
KOSF ZT4	50	1856860000	
ZZE ZP4	25	1855260000	
SDIS SLIM 0.6X3.5X100	1	2749610000	
DEK 5/6 MC NE WS	1000	1609820000	
WS 10/6 MC NE WS	600	1828450000	
DEK 5/6 MM WS	600	2007120000	
ESO 7 DIN A4 WS	10	1607720000	
STR 7 F.SCHT 7	20	0515300000	

Type	Qty.	Order No.	
ZAP/TW ZT4/4AN/2	50	1848360000	
ZTA ZT2.5	17.5 A	25	1827080000
ZVR ZP4	25	1855250000	
KOSF ZT4	50	1856860000	
ZZE ZP4	25	1855260000	
SDIS SLIM 0.6X3.5X100	1	2749610000	
DEK 5/6 MC NE WS	1000	1609820000	
WS 10/6 MC NE WS	600	1828450000	
DEK 5/6 MM WS	600	2007120000	
ESO 7 DIN A4 WS	10	1607720000	
STR 7 F.SCHT 7	20	0515300000	

For detailed information on other accessories and application in the online catalogue



Spring connection with tension clamp technology (Z-Series)

Pluggable terminal blocks

Universal range

A

ZDT 2.5/2

2.5 mm²

ZDT 2.5/2 V

2.5 mm²

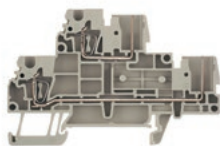

Width/Height/Depth	mm
max. current / max. cond. cross-section	A/mm ²
Max. clamping range	mm ²

5.1 x 80.5 x 52	
24 / 4	
0.13...4	

5.1 x 80.5 x 52	
24 / 4	
0.13...4	

Technical data

Rated data	
Rated voltage	V
Max. voltage of clamp support & pluggable system	V
Rated current	A
for wire cross-section	mm ²
Rated impulse withstand voltage / Pollution severity	
Gauge to IEC 60947-1 / UL 94 flammability rating	
Approvals	
Clamped conductors (H05V/H07V)	
Solid / Stranded	mm ²
Flexible / Flexible with ferrule	mm ²
Stripping length / Blade size	mm/-

IEC 61984, In accordance with IEC 60947-7-1

IEC	UL	CSA	EN 60079-7
500	300	300	
690			
24	20	20	
2.5	AWG 26...12		
	6 kV / 3		
	A2 / V-0		

IEC 61984, In accordance with IEC 60947-7-1

IEC	UL	CSA	EN 60079-7
500			
690			
24			
2.5			
	6 kV / 3		
	A2 / V-0		

Note

Ordering data

	dark beige
	Blue

Plug-in connector

Type	Qty.	Order No.
ZP 2.5/1AN/QV/1	50	1815190000
ZP 2.5/1AN/QV/2	25	1815200000
ZP 2.5/1AN/QV/3	25	1815210000
ZP 2.5/1AN/QV/4	25	1815220000
ZP 2.5/1AN/QV/5	25	1815230000
ZP 2.5/1AN/QV/6	25	1815240000
ZP 2.5/1AN/QV/7	25	1815250000
ZP 2.5/1AN/QV/8	20	1815260000
ZP 2.5/1AN/QV/9	20	1815270000
ZP 2.5/1AN/QV/10	20	1815280000

Note

Accessories

Plug-in cross-connection	
	2-pole
	10-pole
End plate / Partition plate	
	dark beige
Test adapter	
	Standard
	With spigot
Miscellaneous accessories WeiCoS	
	Locking element
	Coding element
	Strain relief
Screwdriver	
	Standard
Marking tags	

Type	Qty.	Order No.
ZQV 2.5N/2	24 A 60	1527540000
ZQV 2.5N/10	24 A 20	1527690000

ZAP/TW ZDT2.5/2	50	1816110000
-----------------	----	------------

ZTA ZT2.5	17.5 A 25	1827080000
ZTA ZT2.5/ZA	17.5 A 25	1847600000

ZVR ZP2.5	25	1816130000
KOSF ZT2.5	50	1816150000
ZZE ZP2.5	25	1816140000

SDIS SLIM 0.6X3.5X100	1	2749610000
-----------------------	---	------------

DEK 5/5 MC NE WS	1000	1609801044
DEK 5/5 MM WS	800	2007110000
WS 8/5 MM WS	800	2007150000

Type	Qty.	Order No.
ZDT 2.5/2 V	50	1084770000

Type	Qty.	Order No.
ZP 2.5/1AN/QV/1	50	1815190000
ZP 2.5/1AN/QV/2	25	1815200000
ZP 2.5/1AN/QV/3	25	1815210000
ZP 2.5/1AN/QV/4	25	1815220000
ZP 2.5/1AN/QV/5	25	1815230000
ZP 2.5/1AN/QV/6	25	1815240000
ZP 2.5/1AN/QV/7	25	1815250000
ZP 2.5/1AN/QV/8	20	1815260000
ZP 2.5/1AN/QV/9	20	1815270000
ZP 2.5/1AN/QV/10	20	1815280000

Type	Qty.	Order No.
ZQV 2.5N/2	24 A 60	1527540000
ZQV 2.5N/10	24 A 20	1527690000

ZAP/TW ZDT2.5/2	50	1816110000
-----------------	----	------------

ZTA ZT2.5	17.5 A 25	1827080000
ZTA ZT2.5/ZA	17.5 A 25	1847600000

ZVR ZP2.5	25	1816130000
KOSF ZT2.5	50	1816150000
ZZE ZP2.5	25	1816140000

SDS 0.6X3.5X100	1	2749340000
-----------------	---	------------

DEK 5/5 MC NE WS	1000	1609801044
DEK 5/5 MM WS	800	2007110000
WS 8/5 MM WS	800	2007150000

For detailed information on other accessories and application in the online catalogue

ZQV 2.5/1.5 (1720700000) connects the upper and lower layer.

ZDT 2.5/2 DU-PE

2.5 mm²

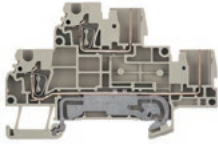

5.1 x 80.5 x 52
24 / 4
0.13...4

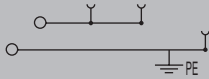

IEC 61984, In accordance with IEC
60947-7-1

IEC	UL	CSA	EN 60079-7
500	300	300	
690			
24	20	20	
2.5	AWG 26...12		
	6 kV / 3		
	A2 / V-0		



Rated connection	Plug-in connection
0.5...4	
0.5...4 / 0.5...2.5	
10 / 0.6 x 3.5 mm	

Type	Qty.	Order No.
ZDT 2.5/2 DU-PE	50	1815160000

Type	Qty.	Order No.
ZP 2.5/1AN/QV/1	50	1815190000
ZP 2.5/1AN/QV/2	25	1815200000
ZP 2.5/1AN/QV/3	25	1815210000
ZP 2.5/1AN/QV/4	25	1815220000
ZP 2.5/1AN/QV/5	25	1815230000
ZP 2.5/1AN/QV/6	25	1815240000
ZP 2.5/1AN/QV/7	25	1815250000
ZP 2.5/1AN/QV/8	20	1815260000
ZP 2.5/1AN/QV/9	20	1815270000
ZP 2.5/1AN/QV/10	20	1815280000

Type	Qty.	Order No.
ZQV 2.5N/2	24 A 60	1527540000
ZQV 2.5N/10	24 A 20	1527690000
ZAP/TW ZDT2.5/2	50	1816110000
ZTA ZT2.5	17.5 A 25	1827080000
ZTA ZT2.5/ZA	17.5 A 25	1847600000
ZVR ZP2.5	25	1816130000
KOSF ZT2.5	50	1816150000
ZZE ZP2.5	25	1816140000
SDIS SLIM 0.6X3.5X100	1	2749610000
DEK 5/5 MC NE WS	1000	1609801044
DEK 5/5 MM WS	800	2007110000
WS 8/5 MM WS	800	2007150000



Spring connection with tension clamp technology (Z-Series)

Pluggable terminal blocks

ZDT 2.5/2 PE

2.5 mm²

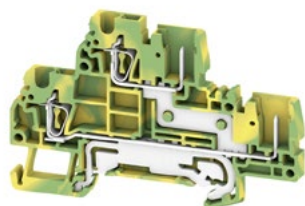

Width/Height/Depth	mm
max. current / max. cond. cross-section	-/mm ²
Max. clamping range	mm ²

5.1 x 80.5 x 52
/ 4
0.13...4

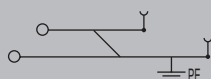

IEC 61984, In accordance with IEC 60947-7-1

Technical data

Rated data	
Rated voltage	V
Max. voltage of clamp support & pluggable system	V
Rated short-time current	
for wire cross-section	mm ²
Rated impulse withstand voltage / Pollution severity	
Gauge to IEC 60947-1 / UL 94 flammability rating	
Approvals	

IEC	UL	CSA	EN 60079-7
500		300	
690			
300 (2.5 mm ²)			
2.5	AWG 26...12		
	/ 3		
	A2 / V-0		

Clamped conductors (H05V/H07V)

Solid / Stranded	mm ²
Flexible / Flexible with ferrule	mm ²
Stripping length / Blade size	mm/-



Rated connection	Plug-in connection
0.5...4	
0.5...4 / 0.5...2.5	
10 / 0.6 x 3.5 mm	

Note

Ordering data

Version	Green/yellow
Note	

Type	Qty.	Order No.
ZDT 2.5/2 PE	50	1815170000

Accessories

End plate / Partition plate	dark beige
Test adapter	Standard With spigot
Miscellaneous accessories WeiCoS	Locking element Coding element Strain relief
Screwdriver	Standard
Marking tags	

Type	Qty.	Order No.
ZAP/TW ZDT2.5/2	50	1816110000
ZTA ZT2.5	17.5 A 25	1827080000
ZTA ZT2.5/ZA	17.5 A 25	1847600000
ZVR ZP2.5	25	1816130000
KOSF ZT2.5	50	1816150000
ZZE ZP2.5	25	1816140000
SDIS SLIM 0.6X3.5X100	1	2749610000
DEK 5/5 MC NE WS	1000	1609801044
WS 10/5 MC NE WS	720	1635000000
DEK 5/5 MM WS	800	2007110000

For detailed information on other accessories and application in the online catalogue

ZTTR 2.5

2.5 mm²

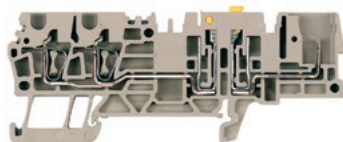

Width/Height/Depth	mm
max. current / max. cond. cross-section	A/mm ²
Max. clamping range	mm ²

5.1 x 87 x 36
18 / 4
0.13...4

Technical data

Rated data	
Rated voltage	V
Max. voltage of clamp support & pluggable system	-
Rated current	A
for wire cross-section	mm ²
Rated impulse withstand voltage / Pollution severity	
Gauge to IEC 60947-1 / UL 94 flammability rating	
Approvals	
Clamped conductors (H05V/H07V)	
Solid / Stranded	mm ²
Flexible / Flexible with ferrule	mm ²
Stripping length / Blade size	mm/-

IEC 61984, In accordance with IEC 60947-7-1

IEC	UL	CSA	EN 60079-7
400	600	300	
16	16	16	
2.5	AWG 26...12	AWG 26...12	
			6 kV / 3
A2 / V-0			

CE

Rated connection	Plug-in connection
0.5...4	
0.5...4 / 0.5...2.5	
10 / 0.6 x 3.5 mm	

Note

Ordering data

Version
dark beige
without isolator, dark beige

Note

Type	Qty.	Order No.
ZTTR 2.5	50	1865510000
ZTTR 2.5 0.TNHE	50	1905470000

Accessories

Plug-in cross-connection	2-pole
	10-pole
End plate / Partition plate	dark beige
End bracket	dark beige
Screwdriver	Standard
Testing / Checking	Test plug
Holder for cartridge fuse 5 x 20 mm	400 V AC/DC, without LED
	10 - 36 V AC/DC, red LED
	140 - 250 V AC/DC, red LED
Module connector (max, 250 V)	without fittings
	with wire jumper
	With 1N4007 diode
Disconnect plug	removable, as replacement for release lever
Marking tags	

Type	Qty.	Order No.	
ZQV 2.5N/2	24 A	60	1527540000
ZQV 2.5N/10	24 A	20	1527690000
ZAP/TW ZTTR2.5		50	1865520000
ZEW 35		20	9540000000
SDIS SLIM 0.6X3.5X100		1	2749610000
PS 2.3 RT	20 mA	20	0180400000
SIHA 3/G20	6.3 A	25	7921560000
SIHA 3/G20/LD 10-36V		25	7921570000
SIHA 3/G20/LD 140-250V		25	7921600000
BEST		50	1833100000
BEST/DRBR	22 A	50	1878570000
BEST/D	1 A	50	1878560000
TNST	20 A	50	1833090000
DEK 5/5 MC NE WS		1000	1609801044
DEK 5/5 MM WS		800	2007110000
WS 8/5 MM WS		800	2007150000

For detailed information on other accessories and application in the online catalogue



Spring connection with tension clamp technology (Z-Series)

Pluggable terminal blocks

Universal range

A

ZRV 1.5

1.5 mm²

Base terminal - plug

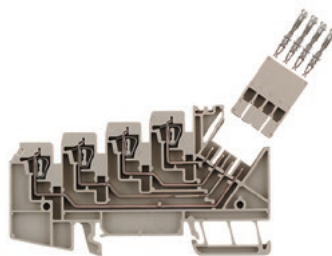

ZRV 1,5/PE

1.5 mm²

Base terminal - plug

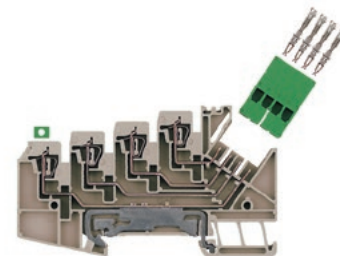

Width/Height/Depth	mm
max. current / max. cond. cross-section	-/mm ²
Max. clamping range	mm ²

5.1 x 89.5 x 52	
/ 2.5	
0.13...2.5	

5.1 x 89.5 x 52	
/ 2.5	
0.13...2.5	

Technical data

Rated data	
Rated voltage	V
Max. voltage of clamp support & pluggable system	-
Rated current	A
for wire cross-section	mm ²
Rated impulse withstand voltage / Pollution severity	
Gauge to IEC 60947-1 / UL 94 flammability rating	
Approvals	
Clamped conductors (H05V/H07V)	
Solid / Stranded	mm ²
Flexible / Flexible with ferrule	mm ²
Stripping length / Blade size	mm/-

IEC 61984, In accordance with IEC 60947-7-1

IEC	UL	CSA	EN 60079-7
63	150		
4	10		
1.5	AWG 26...14		
	1.5 kV / 3		
	A1 / V-0		

IEC 61984, In accordance with IEC 60947-7-1

IEC	UL	CSA	EN 60079-7
63	150		
4	10		
1.5	AWG 26...14		
	1.5 kV / 3		
	A1 / V-0		

Rated connection		Plug-in connection	
0.5...2.5			
0.5...2.5 / 0.5...1.5			
8 / 0.6 x 3.5 mm			

Rated connection		Plug-in connection	
0.5...2.5			
0.5...2.5 / 0.5...1.5			
8 / 0.6 x 3.5 mm			

Note

Ordering data

Version	
	Base terminal
Note	

Type	Qty.	Order No.
ZRV 1.5	50	1698160000

Type	Qty.	Order No.
ZRV 1.5/PE	50	1698170000

Accessories

Plug-in cross-connection	
	2-pole
	10-pole
STGH plug housing	
	With spigot
	Without peg
Crimping contact	
	Reel packaged
	Reel packaged
	Reel packaged
	Single contacts
	Single contacts
	Single contacts
Test adapter	
	Plug housing black
	Black plug housing
End plate / Partition plate	
	beige Wemid
	dark brown
Locking elements	
Tools	
	Pressing tool
	Mounting tool
Marking tags	

Type	Qty.	Order No.
ZQV 2.5/2	24 A 60	1608860000
ZQV 2.5/10	24 A 20	1608940000
STGH 4 ZRV1.5	4 A 50	1698190000
DFFC 5-1.0 ZRV1.5	500	1705320000
DFFC 0.2-0.35 ZRV1.5	500	1705310000
AP ZRV1.5 DB	10	1698180000
HTF ZRV	1	9014840000
DEK 5/5 MC NE WS	1000	1609801044
DEK 5/5 MM WS	800	2007110000
WS 8/5 MM WS	800	2007150000

Type	Qty.	Order No.
ZQV 2.5/2	24 A 60	1608860000
ZQV 2.5/10	24 A 20	1608940000
STGH 4 ZRV1.5/PE GN	4 A 50	1698200000
DFFC 5-1.0 ZRV1.5	500	1705320000
DFFC 0.2-0.35 ZRV1.5	500	1705310000
AP ZRV1.5 DB	10	1698180000
HTF ZRV	1	9014840000
DEK 5/5 MC NE WS	1000	1609801044
DEK 5/5 MM WS	800	2007110000
WS 8/5 MM WS	800	2007150000

For detailed information on other accessories and application in the online catalogue

ZRV 2.5/2

2.5 mm²

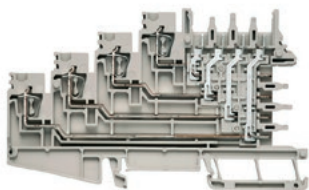

5.2 x 115 x 69.5
10 / 4
0.21...4

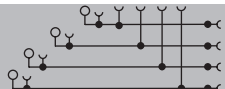

IEC 61984, In accordance with IEC 60947-7-1

IEC	UL	CSA	EN 60079-7
250	300	300	
10	10	10	
2.5	AWG 24...14	AWG 26...14	
4 kV / 3 A2 / V-0			

CE

Rated connection	Plug-in connection
0.5...4 / 0.5...4	
0.5...2.5 / 0.5...2.5	
10 / 0.6 x 3.5 mm	

Type	Qty.	Order No.
ZRV 2.5/2	50	1906970000

Type	Qty.	Order No.	
ZQV 2.5/2	24 A	60	1608860000
ZQV 2.5/10	24 A	20	1608940000
STGH ZRV2.5	50	1907000000	
STGH 0.ZA ZRV2.5	50	1907010000	
FEKO ZRV2.5 0.2-0.35	5000	1854750000	
FEKO ZRV2.5 0.5-1	5000	1854760000	
FEKO ZRV2.5 1.5-2.5	4200	1848480000	
FEKO ET ZRV2.5 0.5-1	500	1893970000	
FEKO ET ZRV2.5 1.5-2.5	500	1893990000	
STGH 0.R/SW ZRV2.5	25	1898420000	
STGH 0.ZA/O.R/SW ZRV2.5	25	1898430000	
AP ZRV2.5	10	1906980000	
HTF AFK 2.5	1	9201040000	
REMOVAL TOOL AFK	1	1866760000	
DEK 5/5 MC NE WS	1000	1609801044	
WS 12/5 MC NE WS	720	1609860000	

ZRV 2.5/1

2.5 mm²

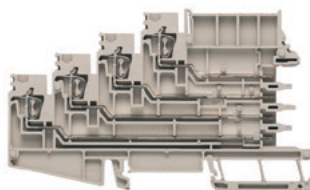

5.2 x 115 x 69.5
/ 4
0.5...4

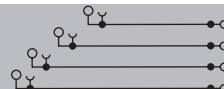

IEC 61984, In accordance with IEC 60947-7-1

IEC	UL	CSA	EN 60079-7
250	300		
10	10		
2.5	AWG 24...14		
4 kV / 3 /V-0			

CE

Rated connection	Plug-in connection
0.5...4	
0.5...2.5 2.5	
10 / 0.6 x 3.5 mm	

Type	Qty.	Order No.
ZRV 2.5/1	50	1906960000

Type	Qty.	Order No.	
ZQV 2.5/2	24 A	60	1608860000
ZQV 2.5/10	24 A	20	1608940000
STGH ZRV2.5	50	1907000000	
STGH 0.ZA ZRV2.5	50	1907010000	
FEKO ZRV2.5 0.2-0.35	5000	1854750000	
FEKO ZRV2.5 0.5-1	5000	1854760000	
FEKO ZRV2.5 1.5-2.5	4200	1848480000	
FEKO ET ZRV2.5 0.5-1	500	1893970000	
FEKO ET ZRV2.5 1.5-2.5	500	1893990000	
STGH 0.R/SW ZRV2.5	25	1898420000	
STGH 0.ZA/O.R/SW ZRV2.5	25	1898430000	
AP ZRV2.5	10	1906980000	
VREL 2 ZRV2.5/4	20	1167890000	
VREL 8 ZRV2.5/4	10	1167910000	
HTF AFK 2.5	1	9201040000	
REMOVAL TOOL AFK	1	1866760000	
DEK 5/5 MC NE WS	1000	1609801044	
WS 12/5 MC NE WS	720	1609860000	



Spring connection with tension clamp technology (Z-Series)

Pluggable terminal blocks

Universal range

A

ZP 2.5/1AN

2.5 mm²

2...17-pole

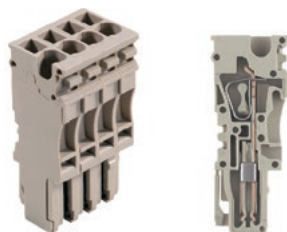

Width/Height/Depth	mm
max. current / max. cond. cross-section	A/mm ²
Max. clamping range	mm ²

5.1 x 16.5 x 41
24 / 4
0.13...4

Technical data

Rated data	
Rated voltage	V
Max. voltage of clamp support & pluggable system	V
Rated current	A
for wire cross-section	mm ²
Rated impulse withstand voltage / Pollution severity	
Gauge to IEC 60947-1 / UL 94 flammability rating	
Approvals	
Clamped conductors (H05V/H07V)	
Solid / Stranded	mm ²
Flexible / Flexible with ferrule	mm ²
Stripping length / Blade size	mm/-

Note

Ordering data

Version	
1-pole	
2-pole	
3-pole	
4-pole	
5-pole	
6-pole	
7-pole	
8-pole	
9-pole	
10-pole	
11-pole	
12-pole	
13-pole	
14-pole	
15-pole	
16-pole	
17-pole	
1-pole (green)	

Note

Accessories

Plug-in cross-connection	
2-pole	
10-pole	
Test adapter	
Standard	
Screwdriver	
Standard	
Protective strip	
DIN A4 sheets	
Paper	
Marking tags	

For detailed information on other accessories and application in the online catalogue

ZP 2.5/1AN/GN/BE

2.5 mm²

2 to 17-pole

Connectors each with one green pole

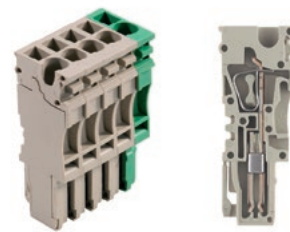

51 x 16 x 41
24 / 4
0.13...4

In accordance with IEC 60947-7-1

IEC	UL	CSA	EN 60079-7
500	300	300	
690			
24	20	20	
2.5	AWG 26...12		
	6 kV / 3		
	A2 / V-0		

Rated connection		Plug-in connection	
0.5...4			
0.5...4 / 0.5...2.5			
10 / 0.6 x 3.5 mm			

Note

Type	Qty.	Order No.
ZP 2.5/1AN/2 GN/BE	25	1867090000
ZP 2.5/1AN/3 GN/BE	25	1867100000
ZP 2.5/1AN/4 GN/BE	25	1867110000
ZP 2.5/1AN/5 GN/BE	25	1867120000
ZP 2.5/1AN/6 GN/BE	25	1867130000
ZP 2.5/1AN/7 GN/BE	25	1867140000
ZP 2.5/1AN/8 GN/BE	20	1867150000
ZP 2.5/1AN/9 GN/BE	20	1867160000
ZP 2.5/1AN/10 GN/BE	20	1867170000
ZP 2.5/1AN/11 GN/BE	20	1867180000
ZP 2.5/1AN/12 GN/BE	20	1867190000
ZP 2.5/1AN/13 GN/BE	10	1867200000
ZP 2.5/1AN/14 GN/BE	10	1867210000
ZP 2.5/1AN/15 GN/BE	10	1867220000
ZP 2.5/1AN/17 GN/BE	10	1867240000

Note

Type	Qty.	Order No.
ZTA ZT2.5	17.5 A 25	1827080000
SDIS SLIM 0.6X3.5X100	1	2749610000
DEK 5/5 MC NE WS	1000	1609801044
WS 10/5 MC NE WS	720	1635000000
DEK 5/5 MM WS	800	2007110000

For detailed information on other accessories and application in the online catalogue

ZP 2.5/1AN/QV

2.5 mm²

1...17-pole

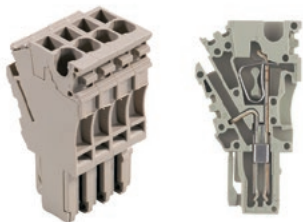

5.1 x 23 x 41
24 / 4
0.13...4

In accordance with IEC 60947-7-1

IEC	UL	CSA	EN 60079-7
500	300	300	
690			
24	20	20	
2.5	AWG 26...12		
			6 kV / A2 / V-0



Rated connection	Plug-in connection
0.5...4	
0.5...4 / 0.5...2.5	
10 / 0.6 x 3.5 mm	

ZP 2.5/2AN/QV

2.5 mm²

1...16-pole

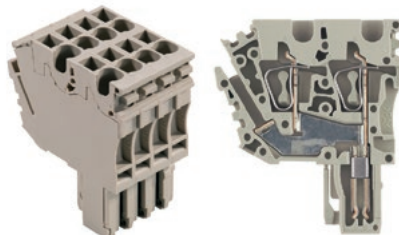

5.1 x 23 x 41
24 / 4
0.13...4

In accordance with IEC 60947-7-1

IEC	UL	CSA	EN 60079-7
500	300	300	
690			
24	20	20	
2.5	AWG 26...12		
			6 kV / 3 A2 / V-0



Rated connection	Plug-in connection
0.5...4	
0.5...4 / 0.5...2.5	
10 / 0.6 x 3.5 mm	

ZPS 2.5/1AN/QV

2.5 mm²

2 to 16-pole

Connectors each with one green pole

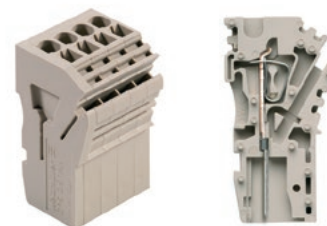

7.6 x 22.55 x 42
24 / 4
0.13...4

IEC 60947-7-1, IEC 61984

IEC	UL	CSA	EN 60079-7
500	300	300	
690			
24	24	20	
2.5	AWG 26...12		AWG 26...12
			6 kV / 3 A2 / V-0



Rated connection	Plug-in connection
0.13...4	
0.5...4 / 0.5...2.5	
10 / 0.6 x 3.5 mm	

Type	Qty.	Order No.
ZP 2.5/1AN/QV/1	50	1815190000
ZP 2.5/1AN/QV/2	25	1815200000
ZP 2.5/1AN/QV/3	25	1815210000
ZP 2.5/1AN/QV/4	25	1815220000
ZP 2.5/1AN/QV/5	25	1815230000
ZP 2.5/1AN/QV/6	25	1815240000
ZP 2.5/1AN/QV/7	25	1815250000
ZP 2.5/1AN/QV/8	20	1815260000
ZP 2.5/1AN/QV/9	20	1815270000
ZP 2.5/1AN/QV/10	20	1815280000
ZP 2.5/1AN/QV/11	20	1815290000
ZP 2.5/1AN/QV/12	20	1815300000
ZP 2.5/1AN/QV/13	10	1815310000
ZP 2.5/1AN/QV/14	10	1815320000
ZP 2.5/1AN/QV/15	10	1815330000
ZP 2.5/1AN/QV/16	10	1815340000
ZP 2.5/1AN/QV/17	10	1815350000
ZP 2.5/1AN/QV/1 GN	50	1820570000

Type	Qty.	Order No.
ZP 2.5/2AN/QV/1	50	1815730000
ZP 2.5/2AN/QV/2	20	1815740000
ZP 2.5/2AN/QV/3	20	1815750000
ZP 2.5/2AN/QV/4	20	1815760000
ZP 2.5/2AN/QV/5	20	1815770000
ZP 2.5/2AN/QV/6	20	1815780000
ZP 2.5/2AN/QV/7	20	1815790000
ZP 2.5/2AN/QV/8	10	1815800000
ZP 2.5/2AN/QV/9	10	1815810000
ZP 2.5/2AN/QV/10	10	1815820000
ZP 2.5/2AN/QV/11	10	1815830000
ZP 2.5/2AN/QV/12	10	1815840000
ZP 2.5/2AN/QV/15	5	1815870000
ZP 2.5/2AN/QV/16	5	1815880000
ZP 2.5/2AN/QV/1 GN	50	1820590000

Type	Qty.	Order No.
ZPS 2.5/1AN/QV/1	50	1865880000
ZPS 2.5/1AN/QV/2	20	1865900000
ZPS 2.5/1AN/QV/3	20	1865910000
ZPS 2.5/1AN/QV/4	20	1865920000
ZPS 2.5/1AN/QV/5	20	1865930000
ZPS 2.5/1AN/QV/6	25	1865940000
ZPS 2.5/1AN/QV/7	20	1865950000
ZPS 2.5/1AN/QV/8	10	1865960000
ZPS 2.5/1AN/QV/9	10	1865970000
ZPS 2.5/1AN/QV/10	10	1865980000
ZPS 2.5/1AN/QV/12	10	1866000000
ZPS 2.5/1AN/QV/14	10	1866020000
ZPS 2.5/1AN/QV/15	10	1866030000
ZPS 2.5/1AN/QV/16	10	1866040000

Type	Qty.	Order No.
ZQV 2.5N/2	24 A 60	1527540000
ZQV 2.5N/10	24 A 20	1527690000
ZTA ZT2.5	17.5 A 25	1827080000
SDIS SLIM 0.6X3.5X100	1	2749610000
DEK 5/5 MC NE WS	1000	1609801044
WS 10/5 MC NE WS	720	1635000000
DEK 5/5 MM WS	800	2007110000

Type	Qty.	Order No.
ZQV 2.5N/2	24 A 60	1527540000
ZQV 2.5N/10	24 A 20	1527690000
ZTA ZT2.5	17.5 A 25	1827080000
SDIS SLIM 0.6X3.5X100	1	2749610000
DEK 5/5 MC NE WS	1000	1609801044
WS 10/5 MC NE WS	720	1635000000
DEK 5/5 MM WS	800	2007110000

Type	Qty.	Order No.
ZQV 2.5N/2	24 A 60	1527540000
ZQV 2.5N/10	24 A 20	1527690000
ZTA ZT2.5	17.5 A 25	1827080000
SDIS SLIM 0.6X3.5X100	1	2749610000
STR 7 F.SCHT 7	20	0515300000
ESO 7 DIN A4 WS	10	1607720000
DEK 5/5 MC NE WS	1000	1609801044
WS 10/5 MC NE WS	720	1635000000
DEK 5/5 MM WS	800	2007110000
ZGB 30	20	1611930000



Spring connection with tension clamp technology (Z-Series)

Pluggable terminal blocks

ZP 4/1AN

4 mm²

1...16-pole

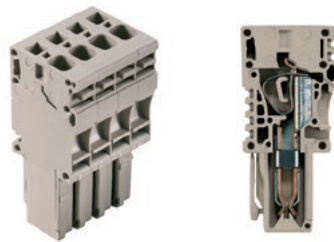

Width/Height/Depth	mm
max. current / max. cond. cross-section	A/mm ²
Max. clamping range	mm ²

6.5 x 22.5 x 47.5
32 / 6
0.13...6

Technical data

Rated data	
Rated voltage	V
Max. voltage of clamp support & pluggable system	-
Rated current	A
for wire cross-section	mm ²
Rated impulse withstand voltage / Pollution severity	
Gauge to IEC 60947-1 / UL 94 flammability rating	
Approvals	
Clamped conductors (H05V/H07V)	
Solid / Stranded	mm ²
Flexible / Flexible with ferrule	mm ²
Stripping length / Blade size	mm/-

In accordance with IEC 60947-7-1

IEC	UL	CSA	EN 60079-7
800	600	600	
32	28	28	
4	AWG 26...10	AWG 26...10	
		8 kV / 3	
		A3 / V-0	

CE

Rated connection	Plug-in connection
0.5...6	
0.5...6 / 0.5...4	
12 / 0.6 x 3.5 mm	

Note

Ordering data

Version	
1-pole	
2-pole	
3-pole	
4-pole	
5-pole	
6-pole	
7-pole	
8-pole	
9-pole	
10-pole	
11-pole	
12-pole	
13-pole	
14-pole	
15-pole	
16-pole	
17-pole	
1-pole (green)	

Type	Qty.	Order No.
ZP 4/1AN/1	50	1848340000
ZP 4/1AN/2	25	1854990000
ZP 4/1AN/3	25	1855000000
ZP 4/1AN/4	25	1855010000
ZP 4/1AN/5	20	1855020000
ZP 4/1AN/6	20	1855030000
ZP 4/1AN/7	20	1855040000
ZP 4/1AN/8	20	1855050000
ZP 4/1AN/9	10	1855060000
ZP 4/1AN/10	10	1855070000
ZP 4/1AN/11	20	1855080000
ZP 4/1AN/12	10	1855090000
ZP 4/1AN/13	10	1855100000
ZP 4/1AN/14	10	1855110000
ZP 4/1AN/1 GN	50	1854980000

Note

Accessories

Plug-in cross-connection	
	2-pole
	10-pole
Test adapter	
	Standard
Screwdriver	
	Standard
Protective strip	
	Paper
DIN A4 sheets	
	Paper
Marking tags	

Type	Qty.	Order No.
SDIS SLIM 0.6X3.5X100	1	2749610000
DEK 5/5 MC NE WS	1000	1609801044
WS 10/6 MC NE WS	600	1828450000

For detailed information on other accessories and application in the online catalogue



**Spring connection with tension clamp technology (Z-Series)
Pluggable terminal blocks – WeiCoS accessories**

Single plates for individual assembly

The WeiCoS individual plates increase flexibility by providing a solution for every task. The plug-in connector is assembled directly on site in line with application requirements. Each individual plate is available in green (GN) and beige (BE).

A

WeiCoS plug

- Marking option

ZP 2.5/1AN ZA

End plate



Type	Qty.	Order No.
ZP 2.5/1AN ZA	50	1875190000
ZP 2.5/1AN ZA BL	50	1009070000
ZP 2.5/1AN ZA GN	50	1875200000
ZP 4/1AN ZA	50	1051940000
ZP 4/1AN ZA BL	50	1356790000
ZP 4/1AN ZA GN	50	1051950000

ZP 2.5/1AN ZA O.RA

Middle plate or end plate



Type	Qty.	Order No.
ZP 2.5/1AN ZA O.RA	50	1875210000
ZP 2.5/1AN ZA O.RA BL	50	1972980000
ZP 2.5/1AN ZA O.RA GN	50	1875220000
ZP 4/1AN ZA O.RA	50	1051910000
ZP 4/1AN ZA O.RA BL	50	2449680000
ZP 4/1AN ZA O.RA GN	50	1051920000

ZP 2.5/1AN

Start plate



Type	Qty.	Order No.
ZP 2.5/1AN	50	1875150000
ZP 2.5/1AN/1 BL	50	1009060000
ZP 2.5/1AN GN	50	1875180000
ZP 4/1AN	50	1051970000
ZP 4/1AN GN	50	1051980000

Ordering data		
2.5 mm ²	Dark beige	
	Blue	
	green	
4.0 mm ²	Dark beige	
	Blue	
	green	
Note		

WeiCoS plug

- Marking option
- Cross-connection option

ZP 2.5/1AN/QV ZA

End plate



Type	Qty.	Order No.
ZP 2.5/1AN/QV ZA	50	1007930000
ZP 2.5/1AN/QV ZA GN	50	1007950000

ZP 2.5/1AN/QV ZA O.RA

Middle plate or end plate



Type	Qty.	Order No.
ZP 2.5/1AN/QV ZA O.RA	50	1007960000
ZP 2.5/1AN/QV ZA O.RA BL	50	1007970000
ZP 2.5/1AN/QV ZA O.RA GN	50	1007980000

ZP 2.5/1AN/QV

Start plate



Type	Qty.	Order No.
ZP 2.5/1AN/QV	50	1007900000
ZP 2.5/1AN/QV GN	50	1007920000

Ordering data		
2.5 mm ²	Dark beige	
	green	
Note		

WeiCoS plug

- Marking option
- Cross-connection option
- 2 cable connection options

ZP 2.5/2AN/QV

End plate



Type	Qty.	Order No.
ZP 2.5/2AN/QV	50	1007810000
ZP 2.5/2AN/QV GN	50	1007830000

ZP 2.5/2AN/QV ZA O.RA

Middle plate or end plate



Type	Qty.	Order No.
ZP 2.5/2AN/QV ZA O.RA	50	1007870000
ZP 2.5/2AN/QV ZA O.RA BL	50	1007880000

Ordering data		
2.5 mm ²	Dark beige	
	green	
Note		

WeiCoS coupling

- Marking option
- Cross-connection option

Ordering data

2.5 mm²

Note

ZPS 2.5/1AN/QV/1

Individual plate



Type	Qty.	Order No.
ZPS 2.5/1AN/QV/1	50	1861040000
ZPS 2.5/1AN/QV/1 GN	50	1861050000

GHDE ZPS2.5/1AN

Cover



Type	Qty.	Order No.
GHDE ZPS2.5/1AN	50	1866070000

Application



Coding elements

- For specific coding of the plug-in stations
- Protection against accidental mistake ensures process reliability

Ordering data

2.5 mm²

4.0 mm²

Note

KOSF ZT

Coding element

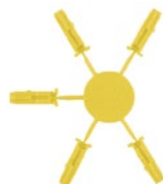

Type	Qty.	Order No.
KOSF ZT2.5	50	1816150000
KOSF ZT4	50	1856860000

Application



Interlock

- ZVR ZP to interlock with the terminal block
- ZVR ZPS interlock, plug – socket

Ordering data

2.5 mm²

4.0 mm²

Note

ZVR ZP 2.5

Locking element



Type	Qty.	Order No.
ZVR ZP2.5	25	1816130000
ZVR ZP4	25	1855250000

ZVR ZPS 2.5

Interlock



Type	Qty.	Order No.
ZVR ZPS2.5	20	1878620000

Application ZVR ZP



Strain reliefs / Protective cover

- ZVR ZP a strain relief transmits mechanical forces to the plastic housing and protects the contact point
- ZAD ZT / ZPS Finger protection Protection of the contact point from dirt

Ordering data

2.5 mm²

4.0 mm²

Note

ZZE ZP

Cable grip



Type	Qty.	Order No.
ZZE ZP2.5	25	1816140000
ZZE ZP2.5/4	25	1866220000
ZZE ZP2.5/8	25	1866230000
ZZE ZP4	25	1855260000

ZAD ZT / ZPS

Protective cover



Type	Qty.	Order No.
ZAD ZT/ZPS2.5	25	1861030000

Application ZZE ZP



Screwed through-wall fixing

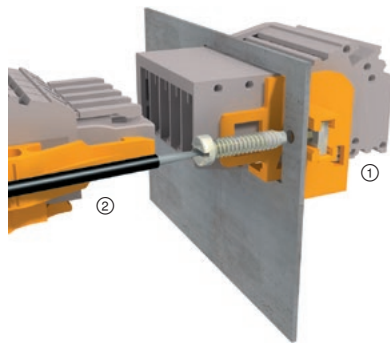
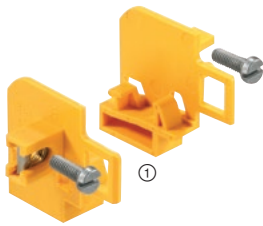

Type	Side	Qty.	Order No.
① ZVLA DF ZPS2.5	Plate	20	1878600000
② ZVR ZPS2.5	Plug	20	1878620000

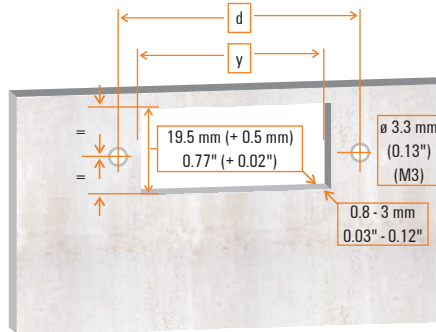

$$y = n \times 5.1 \text{ mm} + 5.5 \text{ mm} \quad y = n \times 0.25'' + 0.216''$$

$$d = n \times 5.1 \text{ mm} + 13.5 \text{ mm} \quad d = n \times 0.25'' + 0.53''$$

Pluggable terminal blocks

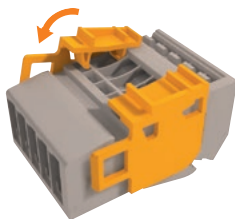

Plug-in connector system with an infinite number of combinations – but always with the same fitting method.

n-pol.	y		d	
	mm	inch(″)	mm	inch(″)
2-pol.	15.7	0.62	23.7	0.93
3-pol.	20.8	0.82	28.8	1.13
4-pol.	25.9	1.02	33.9	1.33
5-pol.	31.0	1.22	38.9	1.53
6-pol.	36.1	1.42	44.1	1.74
7-pol.	41.2	1.62	49.2	1.94
8-pol.	46.3	1.82	54.3	2.14
9-pol.	51.4	2.02	59.4	2.34
10-pol.	56.5	2.22	64.5	2.55
11-pol.	61.6	2.43	69.6	2.74
12-pol.	66.7	2.63	74.7	2.94
13-pol.	71.8	2.83	79.8	3.14
14-pol.	76.9	3.03	84.9	3.34
15-pol.	82.0	3.23	90.0	3.54
16-pol.	87.1	3.43	95.1	3.74

Spring connection with tension clamp technology (Z-Series)
Pluggable terminal blocks - WeiCoS accessories

Set of fixings - coupling

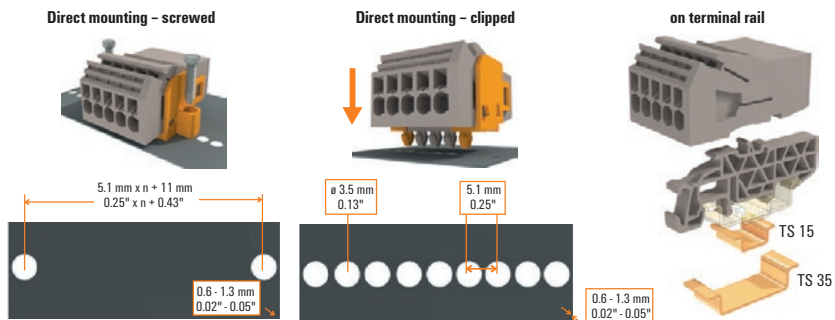

Direct mounting, screwed

ZVLA SC ZPS 2.5



Ordering data
Note

Type	Qty.	Order No.
ZVLA SC ZPS2.5	20	1866240000

Ordering data
Note

Type	Qty.	Order No.

Direct mounting, plugged

ZVLA RC ZPS 2.5



Ordering data
Note

Type	Qty.	Order No.
ZVLA RC ZPS2.5	20	1866260000

Ordering data
Note

BA RC ZPS 2.5



Type	Qty.	Order No.
BA RC ZPS2.5	25	1908560000

on terminal rail

MOFU 15/35 ZPS 2.5

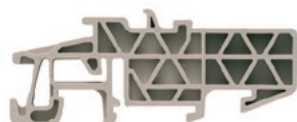

Ordering data
Note

Type	Qty.	Order No.
MOFU 15/35 ZPS2.5	25	1899170000



Spring connection with tension clamp technology (Z-Series)

Terminal blocks with electronic components

Universal range

A

ZDU 2.5/2x2AN/LD+

2.5 mm²

LED indicator

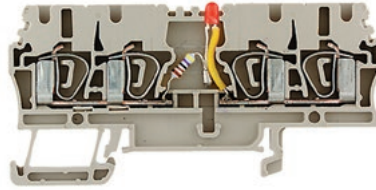

ZDU 2.5/2x2AN/LD-

2.5 mm²

LED indicator

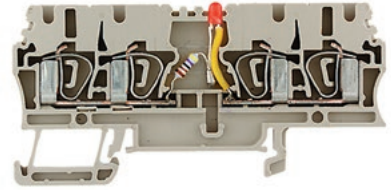

Width/Height/Depth	mm
max. current / max. cond. cross-section	-/mm ²
Max. clamping range	mm ²

5.1 x 79.5 x 38.5	/ 4	
0.05...4		

5.1 x 79.5 x 38.5	/ 4	
0.05...4		

Technical data

Rated data	
Rated voltage of feed-through terminal	V
Rated current	A
for wire cross-section	mm ²
Rated impulse withstand voltage / Pollution severity	
Gauge to IEC 60947-1 / UL 94 flammability rating	
Component 1	
Approvals	

IEC 60947-7-1			
IEC	UL	CSA	EN 60079-7
24			
0.05			
2.5			
		6 kV / 3	
		A3 / V-0	

IEC 60947-7-1			
IEC	UL	CSA	EN 60079-7
24			
0.05			
2.5			
		6 kV / 3	
		A3 / V-0	

Clamped conductors (H05V/H07V)

Solid / Stranded	mm ²
Flexible / Flexible with ferrule	mm ²
Stripping length / Blade size	mm/-

Rated connection	
0.5...4	
0.5...4 / 1.5...2.5	
10 / 0.6 x 3.5 mm	

Rated connection	
0.5...4	
0.5...4 / 1.5...2.5	
10 / 0.6 x 3.5 mm	

Component diode

Type diode	
Forward current	
Reverse voltage	
Forward voltage	

Component LED

Colour	red
Voltage, min.	6V
Voltage, max.	24V
Current	20mA

Colour	red
Voltage, min.	6V
Voltage, max.	24V
Current	20mA

Component resistor

Resistance	4.7kOhm
Power loss	0.4W
Tolerance (%)	1%

Resistance	4.7kOhm
Power loss	0.4W
Tolerance (%)	1%

Note

Ordering data

Version	dark beige
	dark beige (red LED)

Type	Qty.	Order No.
ZDU 2.5/2X2AN/LD+	20	1692590000

Type	Qty.	Order No.
ZDU 2.5/2X2AN/LD-	20	1692600000

Note

Accessories

End plate / Partition plate	dark beige
-----------------------------	------------

Reducing sleeves	for conductors < 1.0 mm ² / AWG 18
	for conductors < 0.5 mm ² / AWG 20

End bracket	dark beige
-------------	------------

Screwdriver	Standard
-------------	----------

Marking tags	
--------------	--

Type	Qty.	Order No.
ZAP/TW 3	50	1608800000
ZRH 2.5/2 GR/V0	1000	1614290000
ZRH 2.5/1 WS	1000	1614300000
ZEW 35	20	9540000000
SDIS SLIM 0.6X3.5X100	1	2749610000
DEK 5/5 MC NE WS	1000	1609801044
WS 10/5 MC NE WS	720	1635000000
DEK 5/5 MM WS	800	2007110000

Type	Qty.	Order No.
ZAP/TW 3	50	1608800000
ZRH 2.5/2 GR/V0	1000	1614290000
ZRH 2.5/1 WS	1000	1614300000
ZEW 35	20	9540000000
SDIS SLIM 0.6X3.5X100	1	2749610000
DEK 5/5 MC NE WS	1000	1609801044
WS 10/5 MC NE WS	720	1635000000
DEK 5/5 MM WS	800	2007110000

For detailed information on other accessories and application in the online catalogue

ZDU 2.5/2x2AN/D+

2.5 mm²

Diode circuit

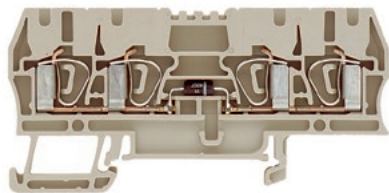

5.1 x 79.5 x 38.5
0.5 / 4
0.5...4



IEC 60947-7-1

IEC	UL	CSA	EN 60079-7
400			
0.5			
2.5			
6 kV / 3			
A3 / V-0			
Diode 1N 4007 /			

CE

Rated connection

0.5...4
0.5...4 / 1.5...2.5
10 / 0.6 x 3.5 mm
1N4007
1A
1300V
0.7V

Type	Qty.	Order No.
ZDU 2.5/2X2AN/D+	20	1650340000

Type	Qty.	Order No.
ZAP/TW 3	50	1608800000
ZRH 2.5/2 GR/V0	1000	1614290000
ZRH 2.5/1 WS	1000	1614300000
ZEW 35	20	9540000000
SDIS SLIM 0.6X3.5X100	1	2749610000
DEK 5/5 MC NE WS	1000	1609801044
WS 10/5 MC NE WS	720	1635000000
DEK 5/5 MM WS	800	2007110000

ZDU 2.5/2x2AN/D-

2.5 mm²

Diode circuit

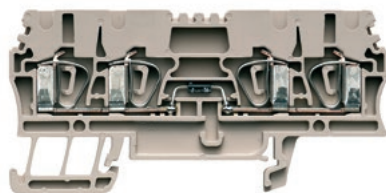

5.1 x 79.5 x 38.5
0.5 / 4
0.5...4

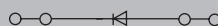

IEC 60947-7-1

IEC	UL	CSA	EN 60079-7
400			
0.5			
2.5			
6 kV / 3			
A3 / V-0			
Diode 1N 4007 /			

CE

Rated connection

0.5...4
0.5...4 / 1.5...2.5
10 / 0.6 x 3.5 mm
1N4007
1A
1300V
0.7V

Type	Qty.	Order No.
ZDU 2.5/2X2AN/D-	20	1650350000

Type	Qty.	Order No.
ZAP/TW 3	50	1608800000
ZRH 2.5/2 GR/V0	1000	1614290000
ZRH 2.5/1 WS	1000	1614300000
ZEW 35	20	9540000000
SDIS SLIM 0.6X3.5X100	1	2749610000
DEK 5/5 MC NE WS	1000	1609801044
WS 10/5 MC NE WS	720	1635000000
DEK 5/5 MM WS	800	2007110000



Spring connection with tension clamp technology (Z-Series)

Terminal blocks with electronic components

ZDU 2.5-2/D+

2.5 mm²

Diode circuit

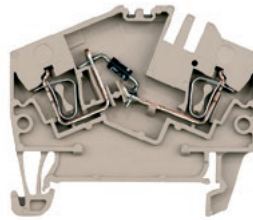

ZDU 2.5-2 0.EL

2.5 mm²

Diode circuit



Width/Height/Depth	mm
max. current / max. cond. cross-section	A/mm ²
Max. clamping range	mm ²

5.1 x 50.5 x 43.5	
0.5 / 2.5	
0.05...2.5	

5.1 x 50.5 x 43.5	
0.5 / 2.5	
0.05...2.5	

Technical data

Rated data	
Rated voltage of feed-through terminal	V
Rated current	A
for wire cross-section	mm ²
Rated impulse withstand voltage / Pollution severity	
Gauge to IEC 60947-1 / UL 94 flammability rating	
Component 1	
Approvals	

IEC 60947-7-1			
IEC	UL	CSA	EN 60079-7
400	600	600	
0.5	1	1	
2.5	AWG 26...12	AWG 26...12	
6 kV / 3			
A2 / V-0			
Diode 1N 4007 /			

IEC 60947-7-1			
IEC	UL	CSA	EN 60079-7
400			
1			
2.5			
6 kV / 3			
A2 / V-0			
Diode 1N 4007 /			

Clamped conductors (H05V/H07V)

Solid / Stranded	mm ²
Flexible / Flexible with ferrule	mm ²
Stripping length / Blade size	mm/-

Rated connection	
0.5...2.5	
0.5...2.5 / 1.5...1.5	
10 / 0.6 x 3.5 mm	

Rated connection	
0.5...2.5	
0.5...2.5 / 1.5...1.5	
10 / 0.6 x 3.5 mm	

Component diode

Type diode	
Forward current	
Reverse voltage	
Forward voltage	

1N4007
1A
1300V
0.7V

Component LED

Colour	
Voltage, min.	
Voltage, max.	
Current	

Component resistor

Resistance	
Power loss	
Tolerance (%)	

Note

Ordering data

Version	
dark beige	
dark beige (red LED)	
Orange	

Type	Qty.	Order No.
ZDU 2.5-2/D+	20	1779110000

Type	Qty.	Order No.
ZDU 2.5-2 0.EL	20	1868870000

Note

Accessories

Plug-in cross-connection	
2-pole	
10-pole	
4-pole	

Type	Qty.	Order No.
ZQV 2.5/2	24 A 60	1608860000
ZQV 2.5/10	24 A 20	1608940000

Type	Qty.	Order No.
ZQV 2.5/2	24 A 60	1608860000
ZQV 2.5/10	24 A 20	1608940000

End plate / Partition plate

Blue	
dark beige	

ZAP/TW7	50	1706110000
---------	----	------------

ZAP/TW7	50	1706110000
---------	----	------------

End bracket

dark beige	
------------	--

ZEW 35	20	9540000000
--------	----	------------

ZEW 35	20	9540000000
--------	----	------------

Screwdriver

Standard	
----------	--

SDIS SLIM 0.6X3.5X100	1	2749610000
-----------------------	---	------------

SDIS SLIM 0.6X3.5X100	1	2749610000
-----------------------	---	------------

Marking tags

DEK 5/5 MC NE WS	1000	1609801044
DEK 5/5 MM WS	800	2007110000
WS 8/5 MM WS	800	2007150000

DEK 5/5 MC NE WS	1000	1609801044
DEK 5/5 MM WS	800	2007110000
WS 8/5 MM WS	800	2007150000

DEK 5/5 MC NE WS	1000	1609801044
DEK 5/5 MM WS	800	2007110000
WS 8/5 MM WS	800	2007150000

For detailed information on other accessories and application in the online catalogue

ZDU 2.5-2/D-

2.5 mm²

Diode circuit

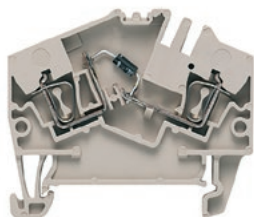

5.1 x 50.5 x 43.5
0.5 / 2.5
0.05...2.5

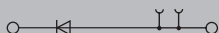

IEC 60947-7-1

IEC	UL	CSA	EN 60079-7
400	600	600	
0.5	1	1	
2.5	AWG 26...12	AWG 26...12	
6 kV / 3 A2 / V-0 Diode 1N 4007 /			

CE ENE

Rated connection
0.5...2.5
0.5...2.5 / 1.5...1.5
10 / 0.6 x 3.5 mm

1N4007
1A
1300V
0.7V

Type	Qty.	Order No.
ZDU 2.5-2/D-	20	1779000000

Type	Qty.	Order No.
ZQV 2.5/2	24 A 60	1608860000
ZQV 2.5/10	24 A 20	1608940000
ZAP/TW7	50	1706110000
ZEW 35	20	9540000000
SDIS SLIM 0.6X3.5X100	1	2749610000
DEK 5/5 MC NE WS	1000	1609801044
DEK 5/5 MM WS	800	2007110000
WS 8/5 MM WS	800	2007150000

ZDU 6-2 O.EL

6 mm²



8.1 x 70 x 51
0.5 / 10
0.5...10

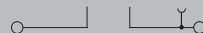

IEC	UL	CSA	EN 60079-7
6			
/ 3 / V-0			

Rated connection
0.5...10 / 0.5...10
0.5...10 / 0.5...6
/ 0.6 x 3.5 mm

Type	Qty.	Order No.
ZDU 6-2 O.EL	20	2855270000

Type	Qty.	Order No.
ZQV 6/2 GE	41 A 60	1627850000
ZQV 6/4 GE	41 A 60	1627870000
ZAP ZDU6-2	50	1771440000
ZEW 35	20	9540000000
SDIS SLIM 0.8X4.0X100	1	2749620000
DEK 5/8 MC NE WS	800	1856740000
WS 8/8 MM WS	500	2007170000
DEK 5/8 MM WS	500	2007130000

ZDK 2.5 EM

2.5 mm²

Double-level terminal

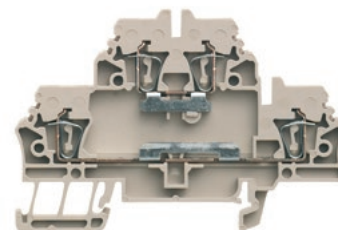

5.1 x 79.5 x 53
20 / 2.5
0.05...2.5



IEC 60947-7-1

IEC	UL	CSA	EN 60079-7
500	300		
20	15		
2.5	AWG 26...14		
6 kV / 3 A2 / V-0			

CE ENE

Rated connection
0.5...2.5
0.5...2.5 / 0.5...2.5
10 / 0.6 x 3.5 mm

Type	Qty.	Order No.
ZDK 2.5 EM	50	1768800000
ZDK 2.5 OR	50	1694140000

Type	Qty.	Order No.
ZQV 2.5/2	24 A 60	1608860000
ZQV 2.5/10	24 A 20	1608940000
ZAP/TW ZDK2.5 BL	20	1748800000
ZAP/TW ZDK2.5	20	1674730000
ZEW 35	20	9540000000
SDIS SLIM 0.6X3.5X100	1	2749610000
DEK 5/5 MC NE WS	1000	1609801044
WS 12/5 MC NE WS	720	1609860000
DEK 5/5 MM WS	800	2007110000
WS 8/5 MM WS	800	2007150000

ZVQ 2.5/1.5 (1720700000) connects the upper and lower layer.



Spring connection with tension clamp technology (Z-Series)

Terminal blocks with electronic components

Universal range

A

ZDK 2.5/LD RT/1

2.5 mm²

LED circuit

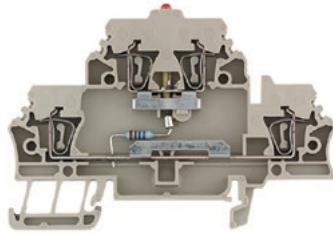

ZDK 2.5/LD RT/2

2.5 mm²

LED circuit

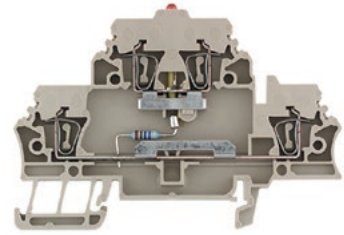

Width/Height/Depth	mm
max. current / max. cond. cross-section	A/mm ²
Max. clamping range	mm ²

5.1 x 79.1 x 53	
10 / 2.5	
0.05...2.5	

5.1 x 79.1 x 53	
10 / 2.5	
0.05...2.5	

Technical data

Rated data	
Rated voltage of feed-through terminal	V
Rated current	A
for wire cross-section	mm ²
Rated impulse withstand voltage / Pollution severity	
Gauge to IEC 60947-1 / UL 94 flammability rating	
Component 1	

IEC 60947-7-1			
IEC	UL	CSA	EN 60079-7
24			
10			
2.5	AWG 26...14		
	/ 3		
	A2 / V-0		

IEC 60947-7-1			
IEC	UL	CSA	EN 60079-7
24			
10			
2.5	AWG 26...14		
	/ 3		
	A2 / V-0		

Clamped conductors (H05V/H07V)

Solid / Stranded	mm ²
Flexible / Flexible with ferrule	mm ²
Stripping length / Blade size	mm/-

Rated connection	
0.5...2.5	
0.5...2.5 / 1.5...1.5	
10 / 0.6 x 3.5 mm	

Rated connection	
0.5...2.5	
0.5...2.5 / 1.5...1.5	
10 / 0.6 x 3.5 mm	

Component diode

Type diode	
Forward current	
Reverse voltage	
Forward voltage	

Component LED

Colour	red
Voltage, min.	6V
Voltage, max.	24V
Current	20mA

red	
6V	
24V	
20mA	

red	
6V	
24V	
20mA	

Component resistor

Resistance	4.7kOhm
Power loss	0.4W
Tolerance (%)	1%

4.7kOhm	
0.4W	
1%	

4.7kOhm	
0.4W	
1%	

Note

Ordering data

Version	
dark beige	
dark beige (red LED)	
Orange	
Note	

Type	Qty.	Order No.
ZDK 2.5/LD RT/1	50	1690010000
Note		

Type	Qty.	Order No.
ZDK 2.5/LD RT/2	50	1693940000
Note		

Accessories

Plug-in cross-connection	
2-pole	
10-pole	
4-pole	
End plate / Partition plate	
Blue	
dark beige	
End bracket	
dark beige	
Screwdriver	Standard
Marking tags	

Type	Qty.	Order No.
ZQV 2.5/2	24 A 60	1608860000
ZQV 2.5/10	24 A 20	1608940000
ZAP/TW ZDK2.5	20	1674730000
ZEW 35	20	9540000000
SDIS SLIM 0.6X3.5X100	1	2749610000
DEK 5/5 MC NE WS	1000	1609801044
DEK 5/5 MM WS	800	2007110000
WS 8/5 MM WS	800	2007150000

Type	Qty.	Order No.
ZQV 2.5/2	24 A 60	1608860000
ZQV 2.5/10	24 A 20	1608940000
ZAP/TW ZDK2.5	20	1674730000
ZEW 35	20	9540000000
SDIS SLIM 0.6X3.5X100	1	2749610000
DEK 5/5 MC NE WS	1000	1609801044
DEK 5/5 MM WS	800	2007110000
WS 8/5 MM WS	800	2007150000

For detailed information on other accessories and application in the online catalogue

ZDK 2.5/D/1

2.5 mm²

Diode circuit

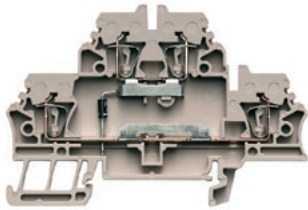

5.1 x 79.1 x 53
0.5 / 2.5
0.05...2.5

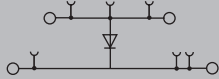

IEC 60947-7-1

IEC	UL	CSA	EN 60079-7
500	300		
0.5	15		
2.5	AWG 26...14		
6 kV / 3 A2 / V-0 Diode 1N 4007 /			

CE

Rated connection

0.5...2.5
0.5...2.5 / 0.5...1.5
10 / 0.6 x 3.5 mm

1N4007

1A

1300V

0.7V

Type	Qty.	Order No.
ZDK 2.5/D/1	50	1690020000

Type	Qty.	Order No.
ZQV 2.5/2	24 A 60	1608860000
ZQV 2.5/10	24 A 20	1608940000

ZAP/TW ZDK2.5 20 1674730000

ZEW 35 20 9540000000

SDIS SLIM 0.6X3.5X100 1 2749610000

DEK 5/5 MC NE WS 1000 1609801044

DEK 5/5 MM WS 800 2007110000

WS 8/5 MM WS 800 2007150000

ZDK 2.5/D/2

2.5 mm²

Diode circuit

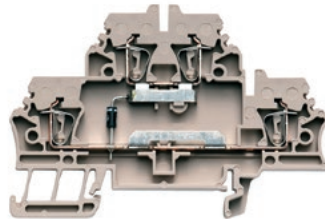

5.1 x 79.1 x 53
0.5 / 2.5
0.05...2.5

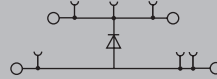

IEC 60947-7-1

IEC	UL	CSA	EN 60079-7
500	300		
0.5	15		
2.5	AWG 26...14		
6 kV / 3 A2 / V-0 Diode 1N 4007 /			

CE

Rated connection

0.5...2.5
0.5...2.5 / 0.5...1.5
10 / 0.6 x 3.5 mm

1N4007

1A

1300V

0.7V

Type	Qty.	Order No.
ZDK 2.5/D/2	50	1690030000

Type	Qty.	Order No.
ZQV 2.5/2	24 A 60	1608860000
ZQV 2.5/10	24 A 20	1608940000

ZAP/TW ZDK2.5 20 1674730000

ZEW 35 20 9540000000

SDIS SLIM 0.6X3.5X100 1 2749610000

DEK 5/5 MC NE WS 1000 1609801044

DEK 5/5 MM WS 800 2007110000

WS 8/5 MM WS 800 2007150000

ZDK 2.5/D/4

2.5 mm²

Diode circuit

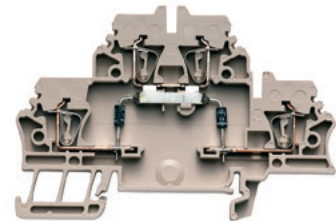

5.1 x 79.1 x 53
0.5 / 2.5
0.05...2.5

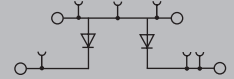

IEC 60947-7-1

IEC	UL	CSA	EN 60079-7
500	300		
0.5	15		
2.5	AWG 26...14		
6 kV / 3 A2 / V-0 Diode 1N 4007 / Diode 1N 4007			

CE

Rated connection

0.5...2.5
0.5...2.5 / 0.5...1.5
10 / 0.6 x 3.5 mm

1N4007

1A

1300V

0.7V

Type	Qty.	Order No.
ZDK 2.5/D/4	50	1690040000

Type	Qty.	Order No.
ZQV 2.5/2	24 A 60	1608860000
ZQV 2.5/10	24 A 20	1608940000

ZAP/TW ZDK2.5 20 1674730000

ZEW 35 20 9540000000

SDIS SLIM 0.6X3.5X100 1 2749610000

DEK 5/5 MC NE WS 1000 1609801044

DEK 5/5 MM WS 800 2007110000

WS 8/5 MM WS 800 2007150000



Spring connection with tension clamp technology (Z-Series)

Terminal blocks with electronic components

Universal range

A

ZDK 2.5/D/5

2.5 mm²

Diode circuit

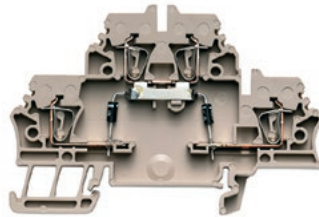

ZDK 2.5/D/6

2.5 mm²

Diode circuit

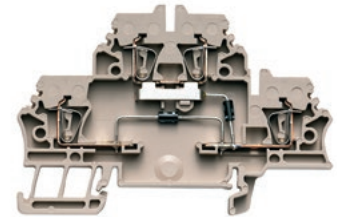

Width/Height/Depth	mm
max. current / max. cond. cross-section	A/mm ²
Max. clamping range	mm ²

5.1 x 79.1 x 53	
0.5 / 2.5	
0.05...2.5	

5.1 x 79.1 x 53	
0.5 / 2.5	
0.05...2.5	

Technical data

Rated data	
Rated voltage of feed-through terminal	V
Rated current	A
for wire cross-section	mm ²
Rated impulse withstand voltage / Pollution severity	
Gauge to IEC 60947-1 / UL 94 flammability rating	
Component 1	

IEC 60947-7-1			
IEC	UL	CSA	EN 60079-7
500	300		
0.5	15		
2.5	AWG 26...14		
6 kV / 3			
A2 / V-0			
Diode 1N 4007 / Diode 1N 4007			

IEC 60947-7-1			
IEC	UL	CSA	EN 60079-7
500	300		
0.5	15		
2.5	AWG 26...14		
6 kV / 3			
A2 / V-0			
Diode 1N 4007 / Diode 1N 4007			

Clamped conductors (H05V/H07V)

Solid / Stranded	mm ²
Flexible / Flexible with ferrule	mm ²
Stripping length / Blade size	mm/-

Rated connection	
0.5...2.5	
0.5...2.5 / 0.5...1.5	
10 / 0.6 x 3.5 mm	

Rated connection	
0.5...2.5	
0.5...2.5 / 0.5...1.5	
10 / 0.6 x 3.5 mm	

Component diode

Type diode	
Forward current	
Reverse voltage	
Forward voltage	

1N4007	
1A	
1300V	
0.7V	

1N4007	
1A	
1300V	
0.7V	

Component LED

Colour	
Voltage, min.	
Voltage, max.	
Current	

Component resistor

Resistance	
Power loss	
Tolerance (%)	

Note

Ordering data

Version	
dark beige	
dark beige (red LED)	
Orange	

Type	Qty.	Order No.
ZDK 2.5/D/5	50	1690050000

Type	Qty.	Order No.
ZDK 2.5/D/6	50	1690060000

Note

Accessories

Plug-in cross-connection	
2-pole	
10-pole	
4-pole	

Type	Qty.	Order No.
ZQV 2.5/2	24 A 60	1608860000
ZQV 2.5/10	24 A 20	1608940000

Type	Qty.	Order No.
ZQV 2.5/2	24 A 60	1608860000
ZQV 2.5/10	24 A 20	1608940000

End plate / Partition plate

Blue	
dark beige	

ZAP/TW ZDK2.5	20	1674730000
---------------	----	------------

ZAP/TW ZDK2.5	20	1674730000
---------------	----	------------

End bracket

dark beige	
------------	--

ZEW 35	20	9540000000
--------	----	------------

ZEW 35	20	9540000000
--------	----	------------

Screwdriver

Standard	
----------	--

SDIS SLIM 0.6X3.5X100	1	2749610000
-----------------------	---	------------

SDIS SLIM 0.6X3.5X100	1	2749610000
-----------------------	---	------------

Marking tags

DEK 5/5 MC NE WS	1000	1609801044
DEK 5/5 MM WS	800	2007110000
WS 8/5 MM WS	800	2007150000

DEK 5/5 MC NE WS	1000	1609801044
DEK 5/5 MM WS	800	2007110000
WS 8/5 MM WS	800	2007150000

DEK 5/5 MC NE WS	1000	1609801044
DEK 5/5 MM WS	800	2007110000
WS 8/5 MM WS	800	2007150000

For detailed information on other accessories and application in the online catalogue

ZDK 2.5/D/9

2.5 mm²

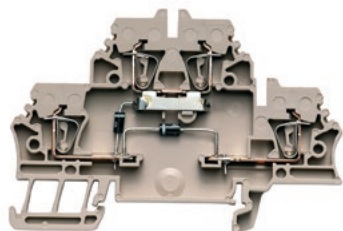

5.1 x 79.1 x 53
0.5 / 2.5
0.05...2.5

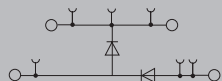

IEC	UL	CSA	EN 60079-7
500	300		
0.5	15		
2.5	AWG 26...14	AWG 26...12	
/ 3			
/ V-0			
Diode /			

®

Rated connection

0.5...2.5 / 0.5...2.5
0.5...2.5 / 0.5...2.5

1N4007

1A

1300V

0.7V

Type	Qty.	Order No.
ZDK 2.5/D/9	50	2738140000

Type	Qty.	Order No.
ZQV 2.5/2	24 A 60	1608860000
ZQV 2.5/10	24 A 20	1608940000
ZAP/TW ZDK2.5	20	1674730000
ZEW 35	20	9540000000
SDIS SLIM 0.6X3.5X100	1	2749610000
DEK 5/5 MC NE WS	1000	1609801044
DEK 5/5 MM WS	800	2007110000
WS 8/5 MM WS	800	2007150000

ZDK 4-2 EL

4 mm²



6.1 x 77.6 x 60
32 / 6
0.13...6

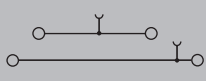

IEC 60947-7-1

IEC	UL	CSA	EN 60079-7
800			
32			
4			
8 kV / 3			
A3 / V-0			

CE

Rated connection

0.5...6
0.5...4
10 / 0.6 x 3.5 mm

Type	Qty.	Order No.
ZDK 4-2 EL	50	8709760000

Type	Qty.	Order No.
ZQV 4/2 GE	32 A 60	1608950000
ZQV 4/10 GE	32 A 20	1609030000
ZAP/TW ZDK4-2	50	8670760000
ZEW 35	20	9540000000
SDIS SLIM 0.6X3.5X100	1	2749610000
DEK 5/6 MM WS	600	2007120000
WS 8/6 MM WS	600	2007160000

ZDK 4-2/D forward

4 mm²



6.1 x 77.6 x 60
0.5 / 6
0.13...6

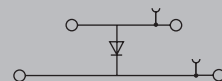

IEC 60947-7-1

IEC	UL	CSA	EN 60079-7
800	600	600	
0.5	1	1	
4	AWG 26...10	AWG 26...10	
8 kV / 3			
A3 / V-0			
Diode 1N 4007 /			

CE

Rated connection

0.5...6 / 1.5...4
0.5...4
10 / 0.6 x 3.5 mm

1N4007

1A

1300V

0.7V

Type	Qty.	Order No.
ZDK 4-2/D FORWARD	50	8670520000

Type	Qty.	Order No.
ZQV 4/2 GE	32 A 60	1608950000
ZQV 4/10 GE	32 A 20	1609030000
ZAP/TW ZDK4-2	50	8670760000
ZEW 35	20	9540000000
SDIS SLIM 0.6X3.5X100	1	2749610000
DEK 5/6 MC NE WS	1000	1609820000
DEK 5/6 MM WS	600	2007120000
WS 8/6 MM WS	600	2007160000





Pluggable Cross-Connection ZQV

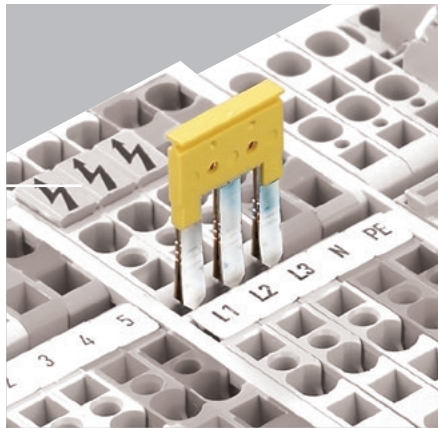

The time-saving, easy-to-use cross-connection comb for terminals, featuring tension clamp technology.

- **ZQV 2.5** as 2- to 10-pole combs and
- **ZQV 2.5N** as 2- to 10-pole combs and
- **ZQV 4** as 2- to 10-pole combs and
- **ZQV 6** as 2- to 4-pole combs and
- **ZQV 10, ZQV 16** and **ZQV 35** as 2-pole combs (bridges)
- **ZQV 35-10, ZQV 35-16** and **ZQV 16-10** used as a reducer cross-connector distributes current from terminals with larger cross-connections to terminals with smaller cross-section.

These versions come with complete shock protection.

However, please note that the rated voltage is reduced to 400 V when using cross-connections. This does not apply to terminals with a rated voltage below 400 V. Here the rated voltage of the used terminal is mandatory.

Breaking out contact elements

If one or more (max. 60 % for reasons of stability and temperature rise) of the contact elements are broken out of the cross-connections, terminals may be bypassed to suit the application.



Fitting and changing crossconnections

The fitting and changing of cross-connections is a trouble-free and fast operation:

- Insert the cross-connection into the cross-connection channel in the terminal...



... and press it fully home. (The cross-connection may not project from the channel.)

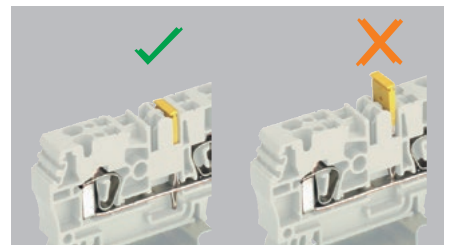

- Remove a cross-connection by simply prising it out with a screwdriver.

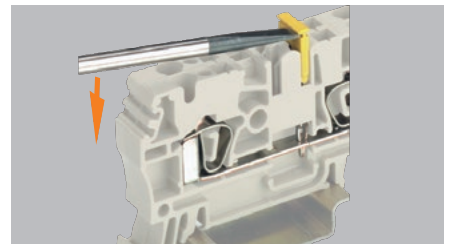

Shortening cross-connections

Cross-connections can be shortened in length using a suitable cutting tool, e.g. KT ZQV (order no. 9002170000). However, three contact elements must always be retained.

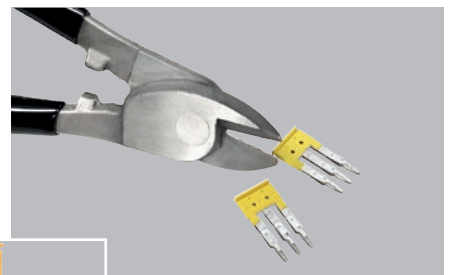

Caution:

Contact elements must not be deformed!



Note:

In the use of manually cut ZQV cross-connections and cross-connections with bare cut edges (>10 poles), the voltage reduces to 25 V.



ZEI 16 supply terminal

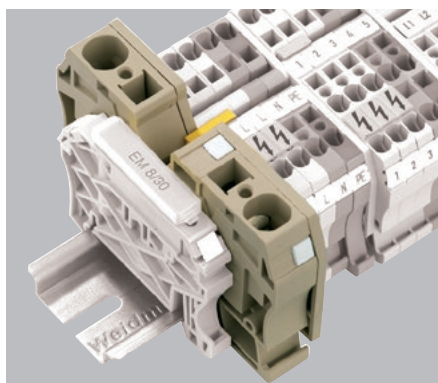

The ZEI 16 supply terminal can be used for supplying current up to a conductor cross-section of 25 mm². Standard cross-connections then distribute the current to any number of terminals with a smaller cross-sectional area.

The following tables show a number of options for distributing current at the supply point, together with corresponding cross-connections and the maximum current.

Integrated partition plate



Output possible on left and right



Output options and corresponding cross-connections

Feed terminal	Output terminal	Cross-connection	Supply left	Supply right
ZEI 16	ZDU 2.5	ZQV 2.5	•	•
	ZDU 2.5 3AN	ZQV 2.5	•	•
	ZDU 2.5 4AN	ZQV 2.5	•	•
	ZDU 2.5 N	ZQV 2.5	•	•
	ZDU 2.5 N/3AN	ZQV 2.5	•	•
	ZDU 2.5N /4AN	ZQV 2.5	•	•
	ZDU 4	ZQV 4	•	•
	ZDU 4 3AN	ZQV 4	•	• ¹⁾
	ZDU 4 4AN	ZQV 4	•	• ¹⁾
	ZDU 6	ZQV 6	•	•
	ZDU 6 3AN	ZQV 6	•	•
	ZTR 2.5	ZQV 2.5	• ²⁾	• ²⁾
	ZTR 2.5 3AN	ZQV 2.5	• ²⁾	• ²⁾
	ZTR 2.5 4AN	ZQV 2.5	•	•
Feed terminal	Output terminal	Cross-connection	Supply left	Supply right
ZEI 6	ZDU 1.5	ZQV 1.5	•	•
	ZDU 1.5 3AN	ZQV 1.5	•	•
	ZDU 1.5 4AN	ZQV 1.5	•	•

1) mit IEPL 2) mit QVAR 3) second pole must be broke out

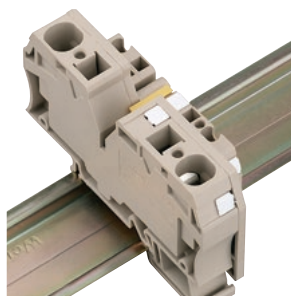

$$I_{max} = \sum I_n \text{ (left)}$$

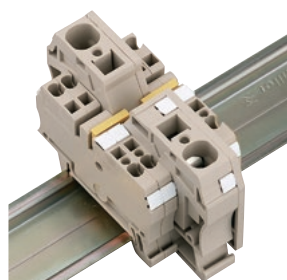

$$I_{max} = \sum I_n \text{ (left)} + \sum I_n \text{ (right)}$$

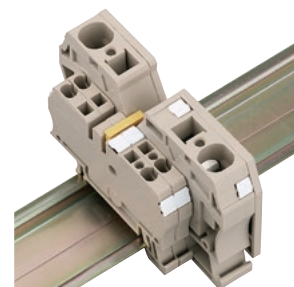

$$I_{max} = \sum I_n \text{ (right)}$$

Maximum current flow I_{max} only with ZEI 16

Feed terminal	Cross-connection	Supply conductor cross-section area	Supply left or right	Supply middle
ZDU 2.5	ZQV 2.5	16 mm ²	48 A	76 A
		25 mm ²	48 A	89 A
ZDU 2.5/4AN	ZQV 2.5	16 mm ²	48 A	76 A
		25 mm ²	48 A	89 A
ZDU 4	ZQV 4	16 mm ²	64 A	76 A
		25 mm ²	66 A	100 A
ZDU 6	ZQV 6	16 mm ²	76 A	76 A
		25 mm ²	82 A	100 A



Supply with standard terminals

According to IEC 60204-1 and IEC 60 439-1, when reducing the conductors within distribution boards and controllers, protective devices for cables and conductors can be installed up to a maximum of 3 meters away from the supply side and need not be positioned at the beginning of the supply side. The conductor before the output fuse must be routed to make it "short-circuit proof".

Supply on the left



Supply options and corresponding cross-connections

Supply terminals		on the left													
		2.5 mm ²			4 mm ²			6 mm ²							
		ZDU	ZDU 3AN	ZDU 4AN	ZDU N	ZDU N/3AN	ZDU N/4AN	ZTR	ZTR 3AN	ZTR 4AN	ZDU	ZDU 3AN	ZDU 4AN	ZDU	ZDU 3AN
1.5 mm ²	ZDU	• ¹⁾								• ¹⁾					
	ZDU 3AN	•		• ¹⁾						• ¹⁾	•				
	ZDU 4AN	•		• ¹⁾						• ¹⁾	•				
2.5 mm ²	ZDU										• ¹⁾	• ¹⁾		• ³⁾	• ¹⁾
	ZDU 3AN										• ²⁾	• ²⁾	• ²⁾	• ²⁾	• ²⁾
	ZDU 4AN										•	• ¹⁾	• ¹⁾	•	• ¹⁾
	ZDU N										•	• ¹⁾	• ¹⁾	•	• ¹⁾
	ZDU N/3AN										• ²⁾	• ²⁾	• ²⁾	• ²⁾	• ²⁾
	ZDU N/4AN										•	• ¹⁾	• ¹⁾	•	• ¹⁾
	ZTR										• ²⁾	• ²⁾	• ²⁾	• ²⁾	• ²⁾
ZTR 3AN										• ²⁾	• ²⁾	• ²⁾	• ²⁾	• ²⁾	
ZTR 4AN										•	•	• ¹⁾	•	• ¹⁾	
4 mm ²	ZDU														•
	ZDU 3AN														•
	ZDU 4AN														•

Supply on the right

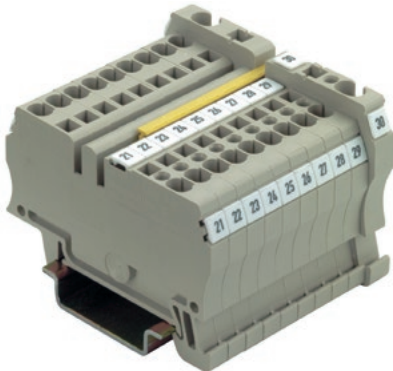

Supply terminals		on the right													
		2.5 mm ²			4 mm ²			6 mm ²							
		ZDU	ZDU 3AN	ZDU 4AN	ZDU N	ZDU N/3AN	ZDU N/4AN	ZTR	ZTR 3AN	ZTR 4AN	ZDU	ZDU 3AN	ZDU 4AN	ZDU	ZDU 3AN
1.5 mm ²	ZDU	•	• ²⁾					• ²⁾	• ²⁾						•
	ZDU 3AN	•	• ²⁾					• ²⁾	• ²⁾						•
	ZDU 4AN	• ¹⁾	• ²⁾					• ²⁾	• ²⁾					• ¹⁾	•
2.5 mm ²	ZDU										•	•	•	• ³⁾	•
	ZDU 3AN										• ²⁾	• ²⁾	• ²⁾	• ²⁾	• ²⁾
	ZDU 4AN										• ¹⁾	• ¹⁾	• ¹⁾	• ¹⁾	• ¹⁾
	ZDU N										•	•	•	•	•
	ZDU N/3AN										• ²⁾	• ²⁾	• ²⁾	• ²⁾	• ²⁾
	ZDU N/4AN										• ¹⁾	• ¹⁾	• ¹⁾	• ¹⁾	• ¹⁾
	ZTR										• ²⁾	• ²⁾	• ²⁾	• ²⁾	• ²⁾
ZTR 3AN										• ²⁾	• ²⁾	• ²⁾	• ²⁾	• ²⁾	
ZTR 4AN										• ¹⁾	• ¹⁾	• ¹⁾	• ¹⁾	•	
4 mm ²	ZDU														•
	ZDU 3AN														•
	ZDU 4AN														•

1) with IEPL
 2) with QVAR
 3) Maximum current value at the smallest cross-section:
 - ZDU 6 with ZQV 2.5/3 on ZDU 2.5 : 55A
 - ZDU 6 with ZQV 2.5/4 on ZDU 2.5 : 57 A

Possible combinations

In one cross-connection channel

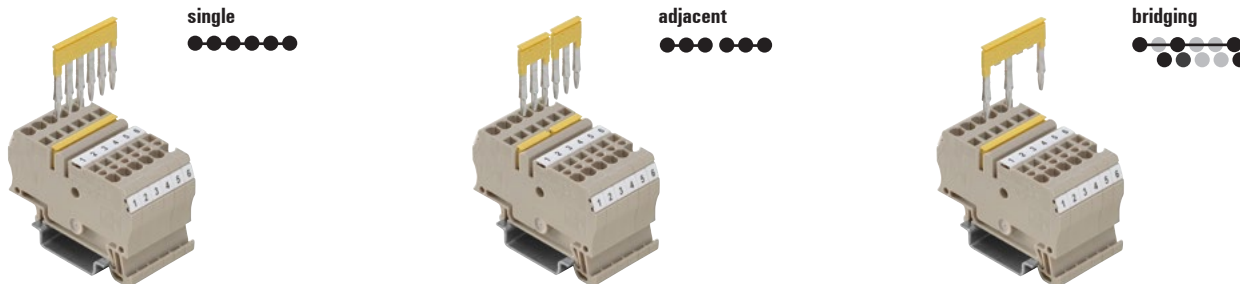

In two cross-connection channel

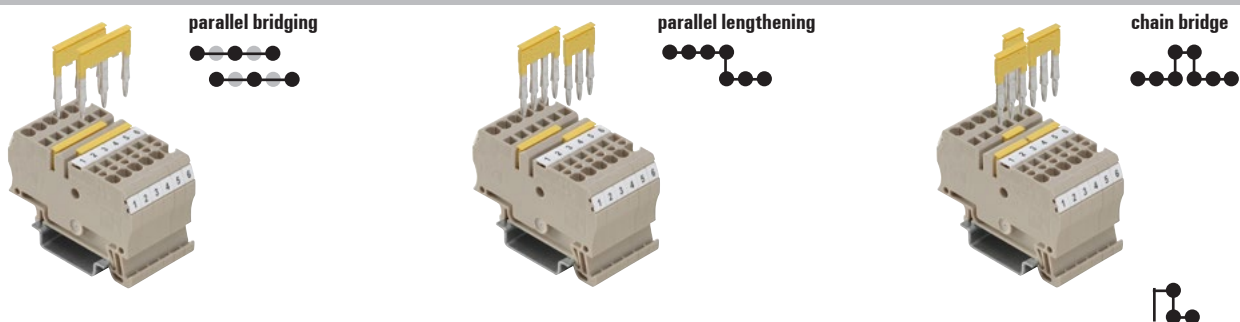

Possible cross-connections of terminals of the same type with corresponding cross-connections

Terminal type	Crosssection	Cross-connection	single	adjacent	bridging	chain bridge	parallel bridging	parallel lengthening
Standard terminals	mm ²							
ZDU 1.5 ...	1.5	ZQV 1.5	•	•	•	•		
ZDK 1.5	1.5	ZQV 1.5	•	•	•			
ZDK 1.5 V	1.5	ZQV 1.5	•	•	•	not bridgeable on top		
ZDK 1.5 DU-PE	1.5	ZQV 1.5	•	•	•	not bridgeable at bottom		
ZRV 1.5 ...	1.5	ZQV 1.5	•	•	•			
ZDU 2.5	2.5	ZQV 2.5	•	•	•	•		
ZDU 2.5 / 3 AN	2.5	ZQV 2.5	•	•	•			
ZDU 2.5 / 4 AN	2.5	ZQV 2.5	•	•	•			
ZDU 2.5N ...	2.5	ZQV 2.5	•	•	•	•		
ZDUA 2.5-2 ...	2.5	ZQV 2.5N	•	•	•			
ZDK 2.5 ...	2.5	ZQV 2.5	•	•	•			
ZDK 2.5 ... PE	2.5	ZQV 2.5	•	•	•	not bridgeable at bottom		
ZDK 2.5-2 ...	2.5	ZQV 2.5	•	•	•			
ZDKPE 2.5-2/ ...	2.5	ZQV 2.5	•	•	•			
ZDLD 2.5 ...	2.5	ZQV 2.5	•	•	•			
ZVLD 2.5	2.5	ZQV 2.5	•	•	•			
ZTR 2.5 ...	2.5	ZQV 2.5	•	•	•			
ZTR 2.5-2	2.5	ZQV 2.5	•	•	•	•		
ZTTR 2.5	2.5	ZQV 2.5N	•	•	•	•		
ZDTR 2.5	2.5	ZQV 2.5N	•	•	•			
ZSI 2.5	2.5	ZQV 6	•	•	•			
ZSI 2.5 2x2AN	2.5	ZQV 4	•	•	•			
ZSI 2.5/2	2.5	ZQV 2.5	•	•	•			
ZT 2.5 ...	2.5	ZQV 2.5N	•	•	•	•		
ZT 2.5/4AN/4	2.5	ZQV 2.5N	•	•	•			
ZP 2.5 ... QV	2.5	ZQV 2.5N	•	•	•			
ZRV 2.5 ...	2.5	ZQV 2.5/...	•	•	•			
ZDU 4 ...	4		•	•	•			
ZDK 4-2 ...	4		•	•	•			
ZDK 4-2 V	4		•	•	•	not bridgeable on top		
ZDK 4-2 ... PE	4		•	•	•	not bridgeable at bottom		
ZT 4 ...	4		•	•	•	•		
ZDU 6	6		•	•	•			
ZDU 6-2 ...	6		•	•	•			
ZSI 6-2 ...	6		•	•	•			
ZTR 6-2	6		•	•	•			
ZDU 10 ...	10		•			•		
ZPE 10 ...	10		•			•		
ZDU 16	16		•			•		
ZPE 16	16		•			•		
ZDU 35	35		•			•		
ZPE 35	35		•			•		



Spring connection with tension clamp technology (Z-Series)
Accessories - Electrical supply

Universal range

A

Cross-connections according to dimensions

ZQV 1.5



Technical data	
Rated current	17.5 A
Ordering data	
Type	Qty. Order No.
1-pole	
2-pole	ZQV 1.5/2 60 1776120000
3-pole	ZQV 1.5/3 60 1776130000
4-pole	ZQV 1.5/4 60 1776140000
5-pole	ZQV 1.5/5 20 1776150000
6-pole	
7-pole	
8-pole	
9-pole	
10-pole	ZQV 1.5/10 20 1776200000
20-pole	
24-pole	
Note	

17.5 A		
Type	Qty.	Order No.
ZQV 1.5/2	60	1776120000
ZQV 1.5/3	60	1776130000
ZQV 1.5/4	60	1776140000
ZQV 1.5/5	20	1776150000
ZQV 1.5/10	20	1776200000

ZQV 2.5



24 A		
Type	Qty.	Order No.
ZQV 2.5/2	60	1608860000
ZQV 2.5/3	60	1608870000
ZQV 2.5/4	60	1608880000
ZQV 2.5/5	20	1608890000
ZQV 2.5/6	20	1608900000
ZQV 2.5/7	20	1608910000
ZQV 2.5/8	20	1608920000
ZQV 2.5/9	20	1608930000
ZQV 2.5/10	20	1608940000
ZQV 2.5/20	20	1908960000

ZQV 4



32 A		
Type	Qty.	Order No.
ZQV 4/2 GE	60	1608950000
ZQV 4/3 GE	60	1608960000
ZQV 4/4 GE	60	1608970000
ZQV 4/5 GE	20	1608980000
ZQV 4/6 GE	20	1608990000
ZQV 4/7 GE	20	1609000000
ZQV 4/8 GE	20	1609010000
ZQV 4/9 GE	20	1609020000
ZQV 4/10 GE	20	1609030000
ZQV 4/20 GE	20	1909010000

Cross-connections according to dimensions

ZQV 35-10

Reducing cross-connection



Technical data	
Rated current	125 A
Ordering data	
Type	Qty. Order No.
1-pole	
2-pole	ZQV 35-10 10 7920100000
3-pole	
4-pole	
5-pole	
6-pole	
7-pole	
8-pole	
9-pole	
10-pole	
20-pole	
24-pole	
Note	

125 A		
Type	Qty.	Order No.
ZQV 35-10	10	7920100000

ZQB 2.5



24 A		
Type	Qty.	Order No.
ZQB 2.5-2	50	1677120000

ZQS 2.5



24 A		
Type	Qty.	Order No.
ZQS 2.5/2	20	1633200000
ZQS 2.5/3	20	1633210000
ZQS 2.5/4	20	1633220000
ZQS 2.5/5	20	1633230000

ZQV 6



41 A		
Type	Qty.	Order No.
ZQV 6/2 GE	60	1627850000
ZQV 6/3 GE	60	1627860000
ZQV 6/4 GE	60	1627870000
ZQV 6/24 GE	10	1908990000

ZQV 10/2



57 A		
Type	Qty.	Order No.
ZQV 10/2	25	1739680000

ZQV 16/2



76 A		
Type	Qty.	Order No.
ZQV 16/2	25	1739690000

ZQV 35/2



125 A		
Type	Qty.	Order No.
ZQV 35/2	10	1739700000

ZVQ 2.5/1.5



24 A		
Type	Qty.	Order No.
ZVQ 2.5/1.5	50	1720700000

Universal range

A



Spring connection with tension clamp technology (Z-Series)

Accessories - test/check

Test adapter

The ZTA snap-on test adapter is used as an individual slice and also as a test adapter strip for measurements. The test adapter simply clips onto the terminal and thus guarantees reliable contact with the live busbar.

Dimensions	
Width / Length / Height	mm
Stripping length	mm
Rated data	
Rated voltage	V
Rated current	A
for wire cross-section	mm ²
Clamped conductors (H05V/H07V)	
Solid / Stranded	mm ²
Flexible / Flexible with ferrule	mm ²
Ordering data	
	1-pole
	with snap-in pegs
Note	

ZTA 1

For terminal width 5.1 mm



Dimensions		
Width / Length / Height	mm	5.1 / / 31.5
Stripping length	mm	6
Rated data		
Rated voltage	V	
Rated current	A	9
for wire cross-section	mm ²	1.5
Clamped conductors (H05V/H07V)		
Solid / Stranded	mm ²	0.5...1.5
Flexible / Flexible with ferrule	mm ²	0.5...1.5
Ordering data		
Type	Qty.	Order No.
ZTA 1	25	1609040000
ZTA 1/ZA	25	1609050000
Note		

ZTA 2

For terminal width 6.1 mm



Dimensions		
Width / Length / Height	mm	6.1 / / 31.5
Stripping length	mm	6
Rated data		
Rated voltage	V	
Rated current	A	9
for wire cross-section	mm ²	1.5
Clamped conductors (H05V/H07V)		
Solid / Stranded	mm ²	0.5...1.5
Flexible / Flexible with ferrule	mm ²	0.5...1.5
Ordering data		
Type	Qty.	Order No.
ZTA 2 ZDU4	25	1609060000
ZTA 2/ZA ZDU4	25	1609070000
Note		

ZTA 3

For terminal width 8.1 mm



Dimensions		
Width / Length / Height	mm	8.1 / / 31.5
Stripping length	mm	6
Rated data		
Rated voltage	V	
Rated current	A	9
for wire cross-section	mm ²	1.5
Clamped conductors (H05V/H07V)		
Solid / Stranded	mm ²	0.5...1.5
Flexible / Flexible with ferrule	mm ²	0.5...1.5
Ordering data		
Type	Qty.	Order No.
ZTA 3 ZDU6	25	1654050000
Note		

Test adapter

The ZTA snap-on test adapter is used as an individual slice and also as a test adapter strip for measurements. The test adapter simply clips onto the terminal and thus guarantees reliable contact with the live busbar.

Dimensions	
Width / Length / Height	mm
Stripping length	mm
Rated data	
Rated voltage	V
Rated current	A
for wire cross-section	mm ²
Clamped conductors (H05V/H07V)	
Solid / Stranded	mm ²
Flexible / Flexible with ferrule	mm ²
Ordering data	
	1-pole
	with snap-in pegs
Note	

ZTA 6

For terminal width 6.1 mm



Dimensions		
Width / Length / Height	mm	6.1 / / 31.5
Stripping length	mm	6
Rated data		
Rated voltage	V	
Rated current	A	17.5
for wire cross-section	mm ²	1.5
Clamped conductors (H05V/H07V)		
Solid / Stranded	mm ²	0.5...1.5
Flexible / Flexible with ferrule	mm ²	0.75...1.5
Ordering data		
Type	Qty.	Order No.
ZTA 6/ZA	25	1780660000
Note		

ZTA 7

For terminal width 8.1 mm



Dimensions		
Width / Length / Height	mm	8.1 / / 31.5
Stripping length	mm	6
Rated data		
Rated voltage	V	
Rated current	A	9
for wire cross-section	mm ²	1.5
Clamped conductors (H05V/H07V)		
Solid / Stranded	mm ²	0.5...1.5
Flexible / Flexible with ferrule	mm ²	0.5...1.5
Ordering data		
Type	Qty.	Order No.
ZTA 7/ZA	25	1780670000
Note		

ZTA ZT2.5

For terminal width 5.1 mm



Dimensions		
Width / Length / Height	mm	5.1 / / 20
Stripping length	mm	10
Rated data		
Rated voltage	V	
Rated current	A	17.5
for wire cross-section	mm ²	1
Clamped conductors (H05V/H07V)		
Solid / Stranded	mm ²	0.5...1
Flexible / Flexible with ferrule	mm ²	0.5...1
Ordering data		
Type	Qty.	Order No.
ZTA ZT2.5	25	1827080000
ZTA ZT2.5/ZA	25	1847600000
Note		



ZTA 4

For terminal width 5.1 mm



5.1 / 31		
10		
11		
1.5		
0.5...1.5		
0.5...1.5		
Type	Qty.	Order No.
ZTA 4	25	1688110000

Test plug

The test points for the PS 2.3 and PS 2.0 test plugs are available for most Z-Series terminals. Quick measurements can be made by inserting the test plug into the opening provided.

Technical data	
Rated current	
Ordering data	
	Test plug
Note	

PS

Plug diameter 2.0 mm



20 mA		
Type	Qty.	Order No.
PS 2.0 OR	20	0293800000

PS 2.3 RT

Plug diameter 2.3 mm



20 mA		
Type	Qty.	Order No.
PS 2.3 RT	20	0180400000



PS ZQV test probes

PS ZQV



- Safe and hand-free measuring of terminals
- Insert into the ZQV contact
- Very flexible silicone safety-measurement cables connect to any measurement instrument.



Technical data

Rated voltage	1000
Max. voltage of clamp support & pluggable system	1000 V
Weight	
Note	For Feed-through terminals with a pitch of 3.5 mm to 8 mm.

Test probes		
Rated voltage	1000	
Max. voltage of clamp support & pluggable system	1000 V	
Weight		
Note	For Feed-through terminals with a pitch of 3.5 mm to 8 mm.	

Ordering data

Version	
Note	

Type	Qty.	Order No.
PS_ZQV_SET	1	1116710000
PS_ZQV	1	1121740000
1x measuring probe red, 1x measuring probe black.		

Reducing sleeves

The use of reducing sleeves simplifies the connection of conductors with smaller cross-sections. Conductors can be reliably inserted into the center of the clamping point without the strands fraying.

Technical data	
Product type	
Ordering data	
	0,13...0,2 mm ² , white
	0,25...0,5 mm ² , grey
	0,75...1,0 mm ² , dark grey
Note	

ZRH 1.5 S



Reducing sleeve			
Type	Qty.	Order No.	
ZRH 1.5S/1	500	1781950000	
Note			

ZRH 1.5 H



Reducing sleeve			
Type	Qty.	Order No.	
ZRH 1.5H/1	1000	1678810000	
ZRH 1.5H/2	1000	1678800000	
Note			

ZRH 1.5 N



Reducing sleeve			
Type	Qty.	Order No.	
ZRH 1.5N/1	1000	1632140000	
ZRH 1.5N/2	1000	1632130000	
Note			

Reducing sleeves

The use of reducing sleeves simplifies the connection of conductors with smaller cross-sections. Conductors can be reliably inserted into the center of the clamping point without the strands fraying.

Technical data	
Product type	
Ordering data	
	0,13...0,2 mm ² , white
	0,25...0,5 mm ² , grey
	0,75...1,0 mm ² , dark grey
Note	

ZRH 2.5



Reducing sleeve			
Type	Qty.	Order No.	
ZRH 2.5/1 WS	1000	1614300000	
ZRH 2.5/2 GR/VO	1000	1614290000	
ZRH 2.5/3	1000	1614280000	
Note			

ZRH 4



Reducing sleeve			
Type	Qty.	Order No.	
ZRH 4/1 WS	1000	1636640000	
Note			

Label

The BZT marking tags enable you to label the middle of the marking channel with the WS 10/5 tags. The marking tags can be put together with pins in order to achieve the greatest degree of stability.

Technical data	
Product type	
Ordering data	
	one-sided, without peg
	one-sided, with peg
	two-sided, without peg
Note	

BZT 1/BZT 2

Tag carriers



Marker holder			
Type	Qty.	Order No.	
BZT 1 WS 10/5	100	1805490000	
BZT 1 ZA WS 10/5	100	1805520000	
BZT 2 WS 10/5	100	1805480000	
Note			



SIHA fuse holder

For 5 x 20 G-fuse cartridges

The SIHA fuse holder converts a simple disconnect terminal into a fuse terminal in next to no time.

Simply remove the isolating lever and insert the fuse plug.

- Simple handling - no tools required
- Housing made of Wemid (VO)
- Rated current 6.3 A
- 1.6 W power loss to DIN VDE 0611-6 at 23 °C ambient temperature (also for 1.5 times rated current - composite arrangement)
- Even fits on 5 mm wide terminals when fitted in offset arrangement



1. Open fuse holder with fingers or screwdriver.

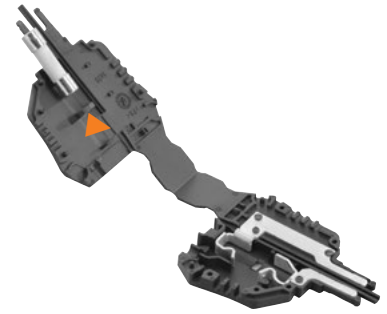

2. Press out old fuse.



3. Position new fuse.

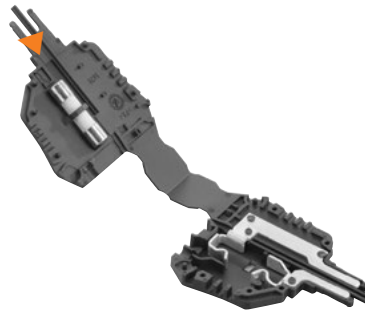

4. Press fuse holder together again with fingers or screwdriver.



- Marking position for Dekafix 5 and space for the E-Fix self-adhesive label, size 8/20



SIHA 3



without LED	Qty.	Order No.
SIHA3/G20	400 V	1 7921560000
with LED (red)		
SIHA3/G20	10 - 36 V	1 7921570000
	35 - 70 V	1 7921580000
	60 - 150 V	1 7921590000
	140 - 250 V	1 7921600000
For test-disconnect terminals versions		
ZTR 2.5/4 AN		
ZTR 2.5...		
ZTR 2.5-2		

SIHA STRAP

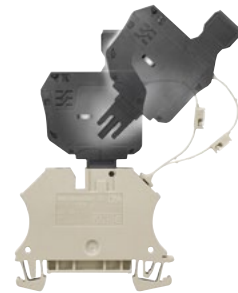

with strap	Qty.	Order No.
SIHA STRAP	20	9537680000

Connector for "retro-fit" assembly

- Receptacle in the terminal is the marking position
- Integrated marking position on the strap
- Slots into fuse holder either on the left or on the right

Component isolating plugs

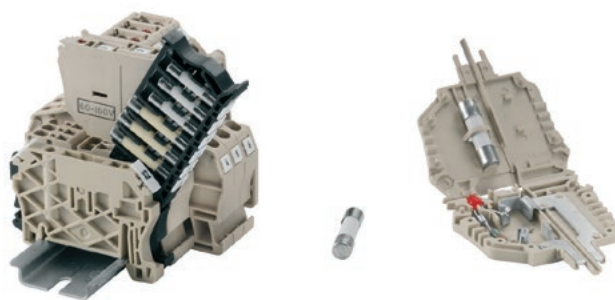

Fuse carrier ZST 1

The ZST 1 fuse-carrier can hold 6 device fuses (5 x 20 or 5 x 25 mm) which are available to be used during servicing work.

ZST 1



Type	Qty.	Order No.
ZST 1	25	1269070000

Ordering data

Note

Accessories holder ZST

The ZST group carrier is used for temporary "parking" of test plugs, cross-connections and fuses which are used during service work. The group carrier can be snapped on to the end of a terminal strip or to the TS 35 rail.

ZST

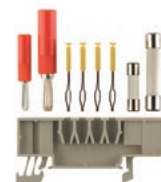

Ordering data

Note

Type	Qty.	Order No.
ZST	10	1678680000

Component plug (up to 250 V)

- Supports reversal

BEST

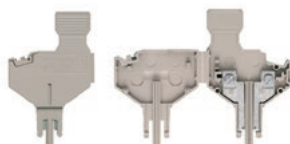

Type	Qty.	Order No.
BEST	50	1833100000
BEST/DRBR	50	1878570000
BEST/D	50	1878560000

Ordering data

without
with wire jumper
with 1N4007 diode

Note

Disconnect plug

TNST



Ordering data

yellow

Note

Type	Qty.	Order No.
TNST	50	1833090000



Reliability connects

Klippon® Connect sets standards with clamping yoke technology

Whatever your requirements for the panel: our screw connection system with patented clamping yoke technology ensures the ultimate in contact safety. You can use both screw-in and plug-in cross-connections for potential distribution. Two conductors of the same diameter can also be connected in a single terminal point in accordance with UL1059. The screw connection has long been an established connection element to meet exacting demands in terms of reliability and functionality. And our W-Series is still setting standards.



Our promise

The high reliability and variety of designs of the terminal blocks with clamping yoke connections make planning easier and optimises operational safety. Klippon® Connect provides a proven response to a range of different requirements.

Flexibility

- The maintenance-free connection means the clamping screw does not need to be re-tightened
- Can be clipped to or removed from the terminal rail in either direction

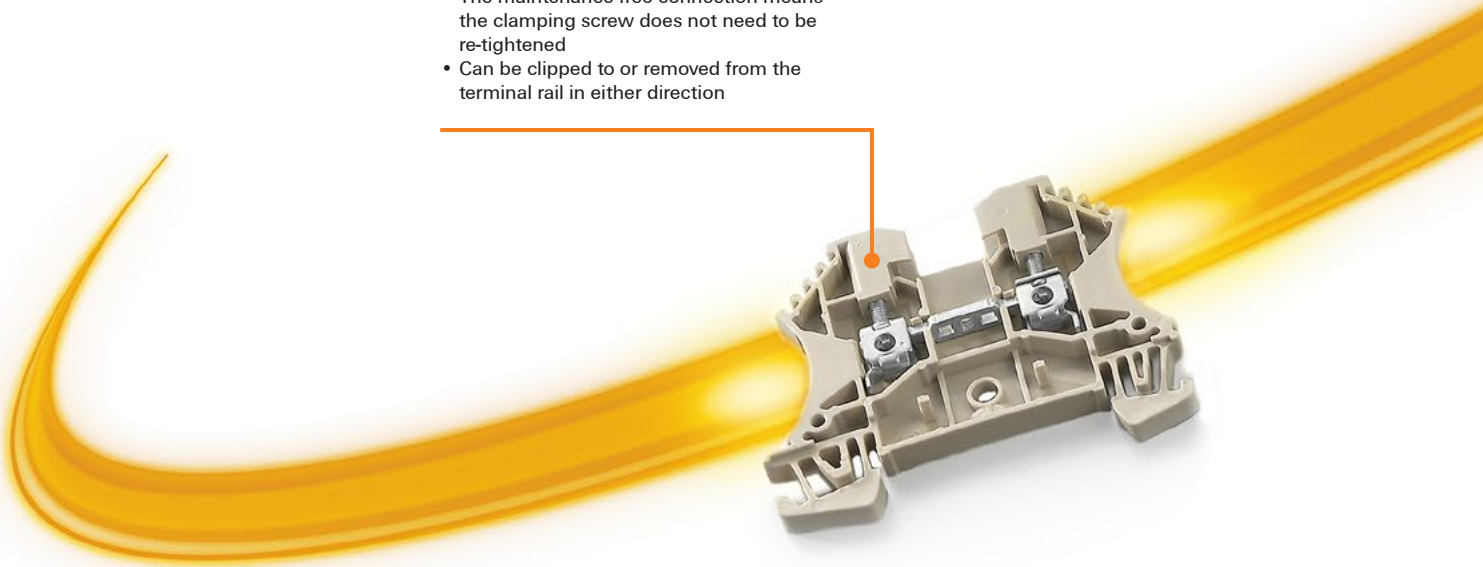

Time saving

- Quick installation as the products are delivered with clamping yoke open
- Identical contours for easier planning

Space saving

- Small „W-Compact“ size saves space in the panel
- Two conductors can be connected for each contact point

Safety

- The clamping yoke properties compensate for temperature-indexed changes to the conductor to prevent loosening
- Vibration-resistant connectors – ideal for applications in harsh conditions
- Protection against incorrect conductor entry
- Copper current bar for low voltages, clamping yoke and screw made of hardened steel
- Precise clamping yoke and current bar design for safe contact with even the smallest of conductors

Overview

You can rely on it: thanks to the range of models and real flexibility, our terminal blocks with clamping yoke technology can be used in a wide range of different applications.

Universal application:

Numerous national and international approvals and qualifications in accordance with a variety of application standards make the W-series a universal connection solution, especially in harsh conditions.

Varied product assortment with wide clamping range:

Our terminal blocks with clamping yoke technology are available in both standard and compact designs. The compact design covers wire cross-sections from 0.05 mm² to 150 mm² and helps save space in the panel. The standard version covers conductor cross sections of up to 240 mm². The identical contours of the terminal blocks make configuration easier and reduces the quantity of accessories required.

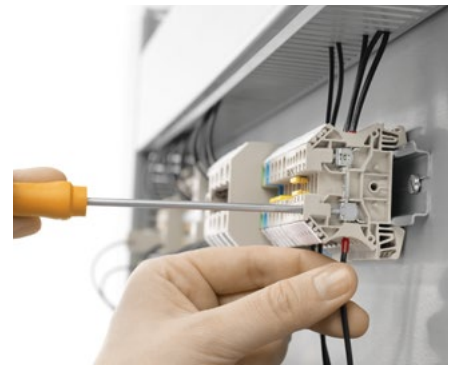

Screw connection with clamping yoke technology (W-Series)

Feed-through terminal blocks

Universal range

A

WDU 1.5/R 3.5

1.5 mm²

Feed-through terminal for TS 15

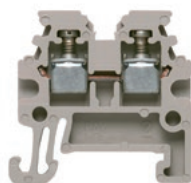

AKZ 1.5

1.5 mm²

Feed-through terminal for TS 15

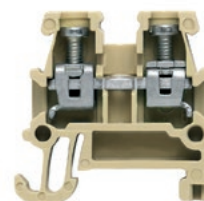

Width/Height/Depth	mm
max. current / max. cond. cross-section	A/mm ²
Max. clamping range	mm ²

3.5 x 24.5 x 24	
17.5 / 1.5	
0.13...1.5	

5.1 x 24.8 x 24	
24 / 2.5	
0.21...2.5	

Technical data

Rated data	
Rated voltage	V
Rated current	A
for wire cross-section	mm ²
Rated impulse withstand voltage / Pollution severity	
Gauge to IEC 60947-1 / UL 94 flammability rating	
Approvals	
Clamped conductors (H05V/H07V)	
Solid / Stranded	mm ²
Flexible / Flexible with ferrule	mm ²
Tightening torque / Clamping screw	Nm
Stripping length / Blade size	mm/-
2 conductors with same cross-section (H05V/H07V)	
Solid / Stranded	-
Flexible / Flexible with ferrule	mm ²
Note	

IEC 60947-7-1 Ex eb II C Gb II 2 G D

IEC	UL	CSA	EN 60079-7
400	300	300	275
17.5	15	10	15
1.5	AWG 26...14	AWG 26...14	1.5 mm ²
4 kV / 3			
A1 / V-0			
DEMKO14ATEX1338U			
Rated connection		Further connection	
0.5...1.5 / 1.5...1.5			
0.5...1.5 / 0.5...0.5		2.5	
0.3...0.3 / (M 2)			
7 / 0.4 x 2.5 mm			
0.5...0.75 / 0.5...0.5			

IEC 60947-7-1 Ex eb II C Gb II 2 G D

IEC	UL	CSA	EN 60079-7
250	150	300	220
17.5	15	10	17.5
1.5	AWG 22...14	AWG 24...16	2.5 mm ²
4 kV / 3			
A1 / V-2			
TUEV18ATEX8221U			
Rated connection		Further connection	
0.5...2.5 / 1.5...1.5			
0.5...1.5 / 0.5...1.5			
0.4...0.6 / (M 2.5)			
7 / 3.0 x 0.5 mm			

Ordering data

Version	
dark beige	
beige	
Blue	
Note	

Type	Qty.	Order No.
WDU 1.5/R3.5	100	1753280000
WDU 1.5/R3.5 BL	100	1754170000

Type	Qty.	Order No.
AKZ 1.5	100	0340460000
AKZ 1.5 BL	100	0340480000

Accessories

Screwable cross-connection	
	2-pole
	10-pole
End plate / Partition plate	
	dark beige
	Blue
End bracket	
	dark beige
Testing / Checking	
	Test plug
	Socket
Marking tags	
	2-pole
	10-pole
Plug-in cross-connection	
	2-pole
	10-pole

Type	Qty.	Order No.
WAP WDU1.5/R3.5	20	1754190000
EW 15	50	0382860000
DEK 5/3.5 MC NE WS	500	1755270000
DEK 5/3.5 MM WS	1000	2007100000
ZQV 1.5N/R3.5/2 GE	17.5 A 50	1754210000
ZQV 1.5N/R3.5/10 GE	17.5 A 20	1754290000

Type	Qty.	Order No.
Q 2 AKZ1.5	24 A 50	0368200000
Q 10 AKZ1.5	24 A 20	0368500000
AP AKZ1.5	50	0340560000
AP AKZ1.5 BL	50	0340580000
EW 15	50	0382860000
PS 2.3 RT	20 mA 20	0180400000
STB 8.5/D4/2.3/M2.5 AKZ	50	0215700000
DEK 5/5 MC NE WS	1000	1609801044

For detailed information on other accessories and application in the online catalogue

WDU 1.5/ZZ

1.5 mm²

Twin connection

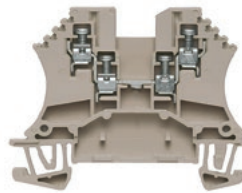

WDU 2.5/1.5/ZR

2.5 mm²

Supplementary connection, right

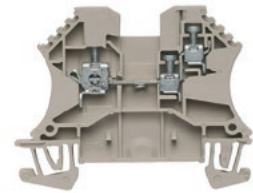

Width/Height/Depth	mm
max. current / max. cond. cross-section	A/mm ²
Max. clamping range	mm ²

Technical data

Rated data	
Rated voltage	V
Rated current	A
for wire cross-section	mm ²
Rated impulse withstand voltage / Pollution severity	
Gauge to IEC 60947-1 / UL 94 flammability rating	
Approvals	
Clamped conductors (H05V/H07V)	
Solid / Stranded	mm ²
Flexible / Flexible with ferrule	mm ²
Tightening torque / Clamping screw	Nm
Stripping length / Blade size	mm/-
2 conductors with same cross-section (H05V/H07V)	
Solid / Stranded	mm ²
Flexible / Flexible with ferrule	mm ²
Note	

Ordering data

Version	
	dark beige
	Blue
Note	

Accessories

Plug-in cross-connection	
	2-pole
	10-pole
Screwable cross-connection	
	2-pole
	10-pole
End plate / Partition plate	
	dark beige
	Blue
	dark beige
	Blue
End bracket	
	dark beige
Testing / Checking	
	Standard
	With spigot
Cover	
	With lightning flash symbol
	Blank, white
Marking tags	
For detailed information on other accessories and application in the online catalogue	

5.1 x 60 x 46.5
23 / 2.5
0.13...2.5

IEC 60947-7-1			
Ex eb II C Gb II 2 G D			
IEC	UL	CSA	EN 60079-7
800	300	300	550
17.5	25	10	17.5
1.5	AWG 26...12	AWG 26...12	2.5 mm ²
8 kV / 3			
A1 / V-0			
DEMKO14ATEX1338U			
Rated connection		Further connection	
0.5...2.5 / 0.5...2.5		0.5...2.5 / 0.5...2.5	
0.5...1.5 / 0.5...1.5		0.5...1.5 / 0.5...1.5	
0.4...0.6 / (M 2.5)		0.4...0.6 / (M 2.5)	
7 / 0.6 x 3.5 mm		7 / SD 0.6 x 3.5	
0.5...2.5		0.5...2.5	
0.5...1 / 0.5...0.75		0.5...1 / 0.5...0.75	

Type	Qty.	Order No.
WDU 1.5/ZZ	100	1031400000
WDU 1.5/ZZ BL	100	1031480000

Type	Qty.	Order No.
ZQV 2.5N/2	24 A 60	1527540000
ZQV 2.5N/10	24 A 20	1527690000
WQV 2.5/2	32 A 50	1053660000
WQV 2.5/10	32 A 20	1054460000
WAP 2.5-10	50	1050000000
WAP 2.5-10 BL	50	1050080000
WAP 16+35 WTW 2.5-10	20	1050100000
WAP 16+35 WTW 2.5-10 BL	20	1050180000
WEW 35/2	50	1061200000
WTA 2 WDU2.5-10	6 A 25	1632320000
WTA 2/ZA WDU2.5-10	6 A 25	1632330000
WAD 4 GE BED	50	1072000000
WAD 4 WS	50	1072100000
DEK 5/5 MC NE WS	1000	1609801044
WS 12/5 MC NE WS	720	1609860000
DEK 5/5 MM WS	800	2007110000
WS 8/5 MM WS	800	2007150000

5.1 x 60 x 46.5
32 / 4
0.05...4

IEC 60947-7-1			
Ex eb II C Gb II 2 G D			
IEC	UL	CSA	EN 60079-7
800	300	300	550
24	20	20	24
2.5	AWG 30...12	AWG 26...14	2.5 mm ²
8 kV / 3			
A3, A1 / V-0			
DEMKO14ATEX1338U			
Rated connection		Further connection	
0.5...4 / 1.5...4		0.5...2.5 / 0.5...2.5	
0.5...4 / 0.5...2.5		0.5...1.5 / 0.5...1.5	
0.4...0.6 / (M 2.5)		0.4...0.6 / (M 2.5)	
10 / 0.6 x 3.5 mm		7 / SD 0.6 x 3.5	
0.5...2.5		0.5...2.5	
0.5...1.5 / 0.5...1.5		0.5...1.5 / 0.5...1.5	

Type	Qty.	Order No.
WDU 2.5/1.5/ZR	100	1024700000
WDU 2.5/1.5/ZR BL	100	1024780000

Type	Qty.	Order No.
ZQV 2.5N/2	24 A 60	1527540000
ZQV 2.5N/10	24 A 20	1527690000
WQV 2.5/2	32 A 50	1053660000
WQV 2.5/10	32 A 20	1054460000
WAP 2.5-10	50	1050000000
WAP 2.5-10 BL	50	1050080000
WAP 16+35 WTW 2.5-10	20	1050100000
WAP 16+35 WTW 2.5-10 BL	20	1050180000
WEW 35/2	50	1061200000
WTA 2 WDU2.5-10	6 A 25	1632320000
WTA 2/ZA WDU2.5-10	6 A 25	1632330000
DEK 5/5 MC NE WS	1000	1609801044
WS 12/5 MC NE WS	720	1609860000
DEK 5/5 MM WS	800	2007110000
WS 8/5 MM WS	800	2007150000

Screw connection with clamping yoke technology (W-Series)

Feed-through terminal blocks

Universal range

A

AKZ 2.5

2.5 mm²

Feed-through terminal for TS 15

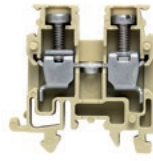

WDU 2.5

2.5 mm²

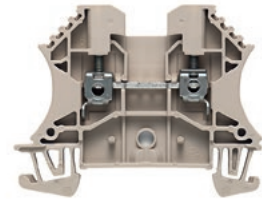

Width/Height/Depth	mm
max. current / max. cond. cross-section	A/mm ²
Max. clamping range	mm ²

5.1 x 25.5 x 26.3
32 / 4
0.13...4

5.1 x 60 x 46.5
32 / 4
0.05...4

Technical data

Rated data	
Rated voltage	V
Rated current	A
for wire cross-section	mm ²
Rated impulse withstand voltage / Pollution severity	
Gauge to IEC 60947-1 / UL 94 flammability rating	
Approvals	
Clamped conductors (H05V/H07V)	
Solid / Stranded	mm ²
Flexible / Flexible with ferrule	mm ²
Tightening torque / Clamping screw	Nm
Stripping length / Blade size	mm/-
2 conductors with same cross-section (H05V/H07V)	
Solid / Stranded	-
Flexible / Flexible with ferrule	-
Note	

IEC 60947-7-1 Ex eb II C Gb II 2 G D

IEC	UL	CSA	EN 60079-7
250	300	300	220
24	10	10	24
2.5	AWG 26...12	AWG 26...10	4 mm ²
4 kV / 3			
A3 / V-2			
TUEV18ATEX8221U			
Rated connection		Further connection	
0.5...4 / 1.5...2.5			
0.5...2.5 / 0.5...2.5			
0.4...0.6 / (M 2.5)			
7 / 0.5 x 3.0 mm			

IEC 60947-7-1 Ex eb II C Gb II 2 G D

IEC	UL	CSA	EN 60079-7
800	600	600	690
24	25	20	24
2.5	AWG 30...12	AWG 26...12	2.5 mm ²
8 kV / 3			
A3 / V-0			
DEMKO14ATEX1338U			
Rated connection		Further connection	
0.5...4 / 0.5...4			
0.5...4 / 0.5...2.5			
0.4...0.8 / (M 2.5)			
10 / 0.6 x 3.5 mm			
0.5...1.5			
0.5...1.5 / 0.5...1.5			

Ordering data

Version	dark beige
	beige
	Blue
Note	

Type	Qty.	Order No.
AKZ 2.5	100	0697160000
AKZ 2.5 BL	100	0697180000

Type	Qty.	Order No.
WDU 2.5	100	1020000000
WDU 2.5 BL	100	1020080000

Accessories

Plug-in cross-connection	2-pole
	10-pole
Screwable cross-connection	2-pole
	10-pole
End plate / Partition plate	dark beige
	Blue
	dark beige
	Blue
End bracket	dark beige
Testing / Checking	Standard
	With spigot
	Test plug
	Socket
Cover	Blank, yellow
	Blank, white
	With lightning flash symbol
Marking tags	
For detailed information on other accessories and application in the online catalogue	

Type	Qty.	Order No.
Q 2 AKZ1.5	24 A 50	0368200000
Q 10 AKZ1.5	24 A 20	0368500000
AP AKZ2.5	50	0697360000
AP AKZ2.5 BL	50	0697380000
TW AKZ2.5	20	0318560000
EW 15	50	0382860000
PS 2.3 RT	20 mA 20	0180400000
STB 8.5/D4/2.3/M2.5 AKZ	50	0215700000
DEK 5/5 MC NE WS	1000	1609801044

Type	Qty.	Order No.
ZQV 2.5N/2	24 A 60	1527540000
ZQV 2.5N/10	24 A 20	1527690000
WQV 2.5/2	32 A 50	1053660000
WQV 2.5/10	32 A 20	1054460000
WAP 2.5-10	50	1050000000
WAP 2.5-10 BL	50	1050080000
WAP 16+35 WTW 2.5-10	20	1050100000
WAP 16+35 WTW 2.5-10 BL	20	1050180000
WEW 35/2	50	1061200000
WTA 2 WDU2.5-10	6 A 25	1632320000
WTA 2/ZA WDU2.5-10	6 A 25	1632330000
WAD 5 MC NE GE	48	1112920000
WAD 5 MC NE WS	48	1112910000
DEK 5/5 MC NE WS	1000	1609801044
WS 12/5 MC NE WS	720	1609860000
DEK 5/5 MM WS	800	2007110000
WS 8/5 MM WS	800	2007150000

WDU 2.5 HV

2.5 mm²

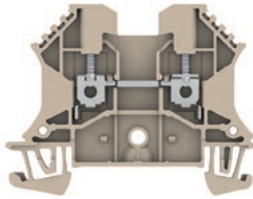

5.1 x 60 x 46.5
32 / 4
0.05...4



IEC 60947-7-1

IEC	UL	CSA	EN 60079-7
1000			
24			
2.5			
8 kV / 3			
A3 / V-0			

Rated connection	Further connection
0.5...4 / 1.5...4	
0.5...4 / 0.5...2.5	
0.4...0.8 / (M 2.5)	
10 / 0.6 x 3.5 mm	
0.5...1.5	
0.5...1.5 / 0.5...1.5	

Type	Qty.	Order No.
WDU 2.5 HV	100	1412950000

Type	Qty.	Order No.
ZQV 2.5N/2	24 A 60	1527540000
ZQV 2.5N/10	24 A 20	1527690000
WQV 2.5/2	32 A 50	1053660000
WQV 2.5/10	32 A 20	1054460000
WAP 2.5-10	50	1050000000
WAP 2.5-10 BL	50	1050080000
WAP 16+35 WTW 2.5-10	20	1050100000
WAP 16+35 WTW 2.5-10 BL	20	1050180000
WEW 35/2	50	1061200000
WTA 2 WDU2.5-10	6 A 25	1632320000
WTA 2/ZA WDU2.5-10	6 A 25	1632330000
WAD 5 MC NE GE	48	1112920000
WAD 5 MC NE WS	48	1112910000
DEK 5/5 MC NE WS	1000	1609801044
WS 12/5 MC NE WS	720	1609860000
DEK 5/5 MM WS	800	2007110000
WS 8/5 MM WS	800	2007150000

WDU 2.5N

2.5 mm²

With screwable cross-connection
Compact design

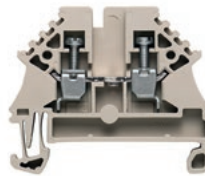

5.1 x 44 x 37
32 / 4
0.05...4

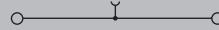

IEC 60947-7-1

IEC	UL	CSA	EN 60079-7
500	300	300	352
24	20	20	24
2.5	AWG 22...12	AWG 26...12	2.5 mm ²
6 kV / 3			
A3 / V-0			

Rated connection	Further connection
0.5...4 / 1.5...4	
0.5...4 / 0.5...2.5	
0.4...0.6 / (M 2.5)	
10 / 0.6 x 3.5 mm	
0.5...1.5 / 0.5...1.5	

Type	Qty.	Order No.
WDU 2.5N	100	1023700000
WDU 2.5N BL	100	1023780000

Type	Qty.	Order No.
WQV 2.5/2	32 A 50	1053660000
WQV 2.5/10	32 A 20	1054460000
WAP WDU2.5N/4N	50	1060000000
WAP WDU2.5N/4N BL	50	1060080000
EW 35	50	0383560000
WTA 1 WDU1.5	6 A 25	1632290000
WTA 1/ZA WDU1.5	6 A 25	1632300000
WAD 4 WS	50	1072100000
WAD 4 GE BED	50	1072000000
DEK 5/5 MC NE WS	1000	1609801044
WS 12/5 MC NE WS	720	1609860000
DEK 5/5 MM WS	800	2007110000
WS 8/5 MM WS	800	2007150000

WDU 2.5N/ZQV

2.5 mm²

With pluggable cross-connection
Compact design

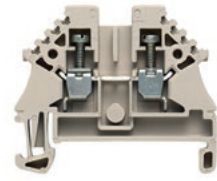

5.1 x 44 x 37
32 / 4
0.05...4



IEC 60947-7-1

IEC	UL	CSA	EN 60079-7
500		300	
24		25	
2.5		AWG 26...12	
6 kV / 3			
A3 / V-0			

Rated connection	Further connection
0.5...4 / 1.5...4	
0.5...4 / 0.25...2.5	
0.4...0.6 / (M 2.5)	
10 / 0.6 x 3.5 mm	
0.5...1.5 / 0.5...1.5	

Type	Qty.	Order No.
WDU 2.5N ZQV	100	1040800000
WDU 2.5N ZQV BL	100	1040880000

Type	Qty.	Order No.
ZQV 2.5N/2	24 A 60	1527540000
ZQV 2.5N/10	24 A 20	1527690000
WAP WDU2.5N/4N	50	1060000000
WAP WDU2.5N/4N BL	50	1060080000
EW 35	50	0383560000
WTA 1 WDU1.5	6 A 25	1632290000
WTA 1/ZA WDU1.5	6 A 25	1632300000
WAD 4 WS	50	1072100000
WAD 4 GE BED	50	1072000000
DEK 5/5 MC NE WS	1000	1609801044
WS 12/5 MC NE WS	720	1609860000
DEK 5/5 MM WS	800	2007110000
WS 8/5 MM WS	800	2007150000

WDU 4

4 mm²

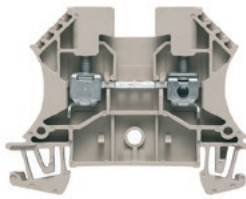

6.1 x 60 x 46.5
41 / 6
0.13...6



Ex eb II
C Gb II 2 G D

IEC 60947-7-1

IEC	UL	CSA	EN 60079-7
800	600	600	690
32	35	35	32
4	AWG 26...10	AWG 26...10	4 mm ²

8 kV / 3

A4 / V-0

DEMKO14ATEX1338U

Rated connection	Further connection
0.5...6 / 1.5...6	
0.5...6 / 0.5...4	
0.5...1 / (M 3)	
10 / 0.6 x 3.5 mm	
0.5...2.5	
0.5...1.5 / 0.5...1.5	

Type	Qty.	Order No.
WDU 4	100	1020100000
WDU 4 BL	100	1020180000

Type	Qty.	Order No.
ZQV 4N/2	32 A 60	1527930000
ZQV 4N/10	32 A 20	1528090000
WQV 4/2	41 A 50	1051960000
WQV 4/10	41 A 20	1052060000
WAP 2.5-10	50	1050000000
WAP 2.5-10 BL	50	1050080000
WAP 16+35 WTW 2.5-10	20	1050100000
WAP 16+35 WTW 2.5-10 BL	20	1050180000
WEW 35/2	50	1061200000
WTA 3 WDU4	6 A 25	1632350000
WTA 3/ZA WDU4	6 A 25	1632360000
WAD 5 MC NE WS	48	1112910000
WAD 5 MC NE GE	48	1112920000
WS 12/6 MC NE WS	600	1609900000
DEK 5/6 MM WS	600	2007120000

WDU 4 HV

4 mm²

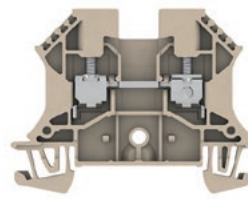

6.1 x 60 x 46.5
41 / 6
0.13...6



IEC 60947-7-1

IEC	UL	CSA	EN 60079-7
1000			
32			
4			

8 kV / 3

A4 / V-0

DEMKO14ATEX1338U

Rated connection	Further connection
0.5...6 / 1.5...6	
0.5...6 / 0.5...4	
0.5...1 / (M 3)	
10 / 0.6 x 3.5 mm	
0.5...2.5	
0.5...1.5 / 0.5...1.5	

Type	Qty.	Order No.
WDU 4 HV	100	1412960000

Type	Qty.	Order No.
ZQV 4N/2	32 A 60	1527930000
ZQV 4N/10	32 A 20	1528090000
WQV 4/2	41 A 50	1051960000
WQV 4/10	41 A 20	1052060000
WAP 2.5-10	50	1050000000
WAP 2.5-10 BL	50	1050080000
WAP 16+35 WTW 2.5-10	20	1050100000
WAP 16+35 WTW 2.5-10 BL	20	1050180000
WEW 35/2	50	1061200000
WTA 3 WDU4	6 A 25	1632350000
WTA 3/ZA WDU4	6 A 25	1632360000
WAD 5 MC NE WS	48	1112910000
WAD 5 MC NE GE	48	1112920000
WS 12/6 MC NE WS	600	1609900000
DEK 5/6 MC NE WS	1000	1609820000
DEK 5/6 MM WS	600	2007120000

WDU 4/ZZ

4 mm²

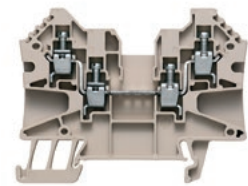

Twin connection

6.1 x 70 x 53
32 / 6
0.05...6



Ex eb II
C Gb II 2 G D

IEC 60947-7-1

IEC	UL	CSA	EN 60079-7
800	600	600	690
32	30	30	29.5
4	AWG 30...10	AWG 30...10	4 mm ²

8 kV / 3

A4 / V-0

DEMKO14ATEX1338U

Rated connection	Further connection
0.5...6	
0.5...4	
0.5...0.8 / (M 3)	
10 / 0.6 x 3.5 mm	
0.5...1.5 / 0.5...1.5	

Type	Qty.	Order No.
WDU 4/ZZ	50	1905060000
WDU 4/ZZ BL	50	1114720000

Type	Qty.	Order No.
ZQV 4N/2	32 A 60	1527930000
ZQV 4N/10	32 A 20	1528090000
WAP WDU/WTR4/ZZ	50	1905150000
WEW 35/2	50	1061200000
WS 12/6 MC NE WS	600	1609900000
DEK 5/6 MC NE WS	1000	1609820000
DEK 5/6 MM WS	600	2007120000



Screw connection with clamping yoke technology (W-Series)

Feed-through terminal blocks

WDU 4/ZR

4 mm²

Supplementary connection, right

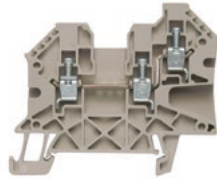

WDU 4N

4 mm²

Compact design

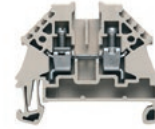

Width/Height/Depth	mm
max. current / max. cond. cross-section	A/mm ²
Max. clamping range	mm ²

Technical data

Rated data	
Rated voltage	V
Rated current	A
for wire cross-section	mm ²
Rated impulse withstand voltage / Pollution severity	
Gauge to IEC 60947-1 / UL 94 flammability rating	
Approvals	
Clamped conductors (H05V/H07V)	
Solid / Stranded	mm ²
Flexible / Flexible with ferrule	mm ²
Tightening torque / Clamping screw	Nm
Stripping length / Blade size	mm/-
2 conductors with same cross-section (H05V/H07V)	
Solid / Stranded	-
Flexible / Flexible with ferrule	mm ²
Note	

Ordering data

Version	
	dark beige
	Blue
Note	

Accessories

Plug-in cross-connection	
	2-pole
	10-pole
End plate / Partition plate	
	dark beige
	Blue
End bracket	
	dark beige
Testing / Checking	
	Standard
	With spigot
Cover	
	With lightning flash symbol
	Blank, white
Marking tags	

6.1 x 63.5 x 53	
32 / 6	
0.05...6	

IEC 60947-7-1	Ex eb II C Gb		II 2 G D
IEC	UL	CSA	EN 60079-7
800	600	600	
32	30	30	
4	AWG 30...10	AWG 30...10	
8 kV / 3			
A4 / V-0			
		UNDEFINED TEXT	
Rated connection		Further connection	
0.5...6		0.5...6	
0.5...4		0.5...4 / 0.5...4	
0.5...0.8 / (M 3)			
10 / 0.6 x 3.5 mm			
Note			

Type	Qty.	Order No.
WDU 4/ZR	50	1905140000
Note		

Type	Qty.	Order No.
ZQV 4N/2	32 A 60	1527930000
ZQV 4N/10	32 A 20	1528090000
Note		
WAP WDU/WTR4/ZR	50	1905070000
Note		
WEW 35/2	50	1061200000
Note		
DEK 5/6 MC NE WS	1000	1609820000
WS 12/6 MC NE WS	600	1609900000
DEK 5/6 MM WS	600	2007120000

6.1 x 44 x 37.7	
39 / 6	
0.13...6	

IEC 60947-7-1	Ex eb II C Gb		II 2 G D
IEC	UL	CSA	EN 60079-7
500	300	300	352
32	10	10	31
4	AWG 26...10	AWG 26...10	4 mm ²
6 kV / 3			
A4 / V-0			
		DEMKO14ATEX1338U	
Rated connection		Further connection	
0.5...6 / 1.5...6			
0.5...4 / 0.5...4			
0.5...1 / (M 3)			
11 / 0.6 x 3.5 mm			
Note			

Type	Qty.	Order No.
WDU 4N	100	1042600000
WDU 4N BL	100	1042680000
Note		

Type	Qty.	Order No.
ZQV 4N/2	32 A 60	1527930000
ZQV 4N/10	32 A 20	1528090000
Note		
WAP WDU2.5N/4N	50	1060000000
WAP WDU2.5N/4N BL	50	1060080000
Note		
WEW 35/2	50	1061200000
Note		
WTA 1 WDU1.5	6 A 25	1632290000
WTA 1/ZA WDU1.5	6 A 25	1632300000
Note		
WAD 4 GE BED	50	1072000000
WAD 4 WS	50	1072100000
Note		
DEK 5/6 MC NE WS	1000	1609820000
WS 12/6 MC NE WS	600	1609900000
DEK 5/6 MM WS	600	2007120000

For detailed information on other accessories and application in the online catalogue

WDU 4 SL

4 mm²

WDU 4 SL/EN

4 mm²

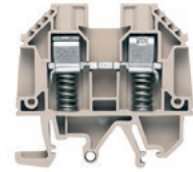
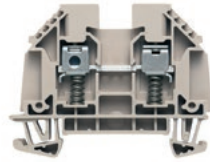

Width/Height/Depth	mm
max. current / max. cond. cross-section	A/mm ²
Max. clamping range	mm ²

6.1 x 60 x 46.5
41 / 6
0.22...6

6.1 x 60 x 51.5
41 / 6
0.22...6

Technical data

Rated data	
Rated voltage	V
Rated current	A
for wire cross-section	mm ²
Rated impulse withstand voltage / Pollution severity	
Gauge to IEC 60947-1 / UL 94 flammability rating	
Approvals	
Clamped conductors (H05V/H07V)	
Solid / Stranded	mm ²
Flexible / Flexible with ferrule	mm ²
Tightening torque / Clamping screw	Nm
Stripping length / Blade size	mm/-
2 conductors with same cross-section (H05V/H07V)	
Solid / Stranded	-
Flexible / Flexible with ferrule	mm ²
Note	

IEC 60947-1	Ex eb II C Gb	Ex	II 2 G D
IEC	UL	CSA	EN 60079-7
690	600	300	440
32	30	25	32
4	AWG 22...10	AWG 22...10	4 mm ²
6 kV / 3			
A4 / V-0			
CE, CCC, ENEC, KEMA, VDE, DEMKO14ATEX1338U			
Rated connection	Further connection		
0.5...6 / 1.5...6			
0.5...4			
0.5...1 / (M 3)			
15 / 0.6 x 3.5 mm			
0.5...1.5 / 0.5...1.5			

IEC 60947-1	Ex eb II C Gb	Ex	II 2 G D
IEC	UL	CSA	EN 60079-7
690	600	300	690
32	30	25	32
4	AWG 22...10	AWG 22...10	4 mm ²
6 kV / 3			
A4 / V-0			
CE, CCC, ENEC, KEMA, VDE, DEMKO14ATEX1338U			
Rated connection	Further connection		
0.5...6 / 1.5...6			
0.5...4			
0.5...1 / (M 3)			
15 / 0.6 x 3.5 mm			
0.5...1.5 / 0.5...1.5			

Ordering data

Version	
	dark beige
	dark beige
	Blue
Note	

Type	Qty.	Order No.
WDU 4 SL	50	9537440000
WDU 4 SL BL	50	9203060000

Type	Qty.	Order No.
WDU 4 SL/EN	50	9537450000

Accessories

Screwable cross-connection	
	2-pole
	10-pole
End plate / Partition plate	
	dark beige
	dark beige
	Blue
	Blue
End bracket	
	dark beige
Testing / Checking	
	Standard
Cover	
	Blank, yellow
	Blank, white
Hak. Cable lugs	
Marking tags	
Plug-in cross-connection	
	2-pole
	10-pole
For detailed information on other accessories and application in the online catalogue	

Type	Qty.	Order No.
WQV 4/2	41 A 50	1051960000
WQV 4/10	41 A 20	1052060000
WAP 2.5-10	50	1050000000
WAP 16*35 WTW 2.5-10	20	1050100000
WEW 35/2	50	1061200000
WTA 3 WDU4	6 A 25	1632350000
HBT 1.5 - 3,0 RT	100	1312440000
HBT 2,5 - 3,0 BL	100	1312450000
WS 12/6 MC NE WS	600	1609900000
ZQV 4N/2	32 A 60	1527930000
ZQV 4N/10	32 A 20	1528090000

Type	Qty.	Order No.
WQV 4/2	41 A 50	1051960000
WQV 4/10	41 A 20	1052060000
WAP 2.5-10	50	1050000000
WAP 16*35 WTW 2.5-10	20	1050100000
WEW 35/2	50	1061200000
WTA 3 WDU4	6 A 25	1632350000
HBT 1.5 - 3,0 RT	100	1312440000
HBT 2,5 - 3,0 BL	100	1312450000
WS 12/6 MC NE WS	600	1609900000
ZQV 4N/2	32 A 60	1527930000
ZQV 4N/10	32 A 20	1528090000

Screw connection with clamping yoke technology (W-Series)

Feed-through terminal blocks

Universal range

A

WDU 6

6 mm²

WDU 6 HV

6 mm²

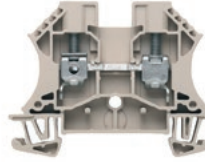

Width/Height/Depth	mm
max. current / max. cond. cross-section	A/mm ²
Max. clamping range	mm ²

7.9 x 60 x 46.5	
57 / 10	
0.22...10	

7.9 x 60 x 46.5	
57 / 10	
0.22...10	

Technical data

Rated data	
Rated voltage	V
Rated current	A
for wire cross-section	mm ²
Rated impulse withstand voltage / Pollution severity	
Gauge to IEC 60947-1 / UL 94 flammability rating	
Approvals	
Clamped conductors (H05V/H07V)	
Solid / Stranded	mm ²
Flexible / Flexible with ferrule	mm ²
Tightening torque / Clamping screw	Nm
Stripping length / Blade size	mm/-
2 conductors with same cross-section (H05V/H07V)	
Solid / Stranded	mm ²
Flexible / Flexible with ferrule	mm ²
Note	

IEC 60947-7-1 Ex eb II C Gb II 2 G D

IEC	UL	CSA	EN 60079-7
800	600	600	690
41	50	50	41
6	AWG 22...8	AWG 22...8	6 mm ²
8 kV / 3			
A5 / V-0			
DEMKO14ATEX1338U			
Rated connection		Further connection	
0.5...10 / 1.5...10			
0.5...10 / 0.5...6			
0.8...1.6 / (M 3.5)			
12 / 0.8 x 4.0 mm			
0.5...2.5			
0.5...2.5 / 0.5...2.5			

IEC 60947-7-1

IEC	UL	CSA	EN 60079-7
1000			
41			
6			
8 kV / 3			
A5 / V-0			
C E			
Rated connection		Further connection	
0.5...10 / 1.5...10			
0.5...10 / 0.5...6			
0.8...1.6 / (M 3.5)			
12 / 0.8 x 4.0 mm			
0.5...2.5			
0.5...2.5 / 0.5...2.5			

Ordering data

Version	
	dark beige
	dark beige
	Blue
Note	

Type	Qty.	Order No.
WDU 6	100	1020200000
WDU 6 BL	100	1020280000

Type	Qty.	Order No.
WDU 6 HV	100	1412970000
WDU 6 IR	100	1393350000

Accessories

Screwable cross-connection	
	2-pole
	10-pole
End plate / Partition plate	
	dark beige
	dark beige
	Blue
	Blue
End bracket	
	dark beige
Testing / Checking	
	Standard
Cover	
	Blank, yellow
	Blank, white
Hak. Cable lugs	
Marking tags	
Plug-in cross-connection	
	2-pole
	10-pole
For detailed information on other accessories and application in the online catalogue	

Type	Qty.	Order No.
WQV 6/2	57 A 50	1052360000
WQV 6/10	57 A 20	1052260000
WAP 2.5-10	50	1050000000
WAP 16+35 WTW 2.5-10	20	1050100000
WAP 2.5-10 BL	50	1050080000
WAP 16+35 WTW 2.5-10 BL	20	1050180000
WEW 35/2	50	1061200000
WTA 3 WDU4	6 A 25	1632350000
WAD 8 MC NE GE	48	1112950000
WAD 8 MC NE WS	48	1112940000
DEK 5/8 MC NE WS	800	1856740000
WS 12/6.5 MC NE WS	540	1609920000
WS 8/8 MM WS	500	2007170000
DEK 5/8 MM WS	500	2007130000

Type	Qty.	Order No.
WQV 6/2	57 A 50	1052360000
WQV 6/10	57 A 20	1052260000
WAP 2.5-10	50	1050000000
WAP 16+35 WTW 2.5-10	20	1050100000
WAP 2.5-10 BL	50	1050080000
WAP 16+35 WTW 2.5-10 BL	20	1050180000
WEW 35/2	50	1061200000
WTA 3 WDU4	6 A 25	1632350000
WAD 8 MC NE GE	48	1112950000
WAD 8 MC NE WS	48	1112940000
DEK 5/8 MC NE WS	800	1856740000
WS 12/8 PLUS MC NE WS	420	1906000000
WS 8/8 MM WS	500	2007170000
DEK 5/8 MM WS	500	2007130000

WDU 6 SL

6 mm²

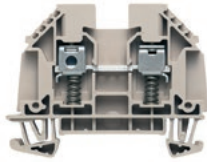

7.9 x 60 x 46.5
57 / 6
0.5...6



IEC 60947-7-1 Ex eb II C Gb II 2 G D

IEC	UL	CSA	EN 60079-7
630	150	300	275
41	50	45	40
6	AWG 20...8	AWG 20...8	6 mm ²

6 kV / 2
A5 / V-0

DEMKO14ATEX1338U

Rated connection	Further connection
0.5...6 6	
0.5...6	
0.8...1.6 / (M 3.5)	
16 / 0.8 x 4.0 mm	

WDU 6 SL/EN

6 mm²



7.9 x 60 x 51.1
57 / 6
0.5...6

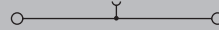

IEC 60947-7-1 Ex eb II C Gb II 2 G D

IEC	UL	CSA	EN 60079-7
690	150	300	440
41	50	45	40
6	AWG 20...8	AWG 20...8	6 mm ²

6 kV / 3
A5 / V-0

DEMKO14ATEX1338U

Rated connection	Further connection
0.5...6 6	
0.5...6	
0.8...1.6 / (M 3.5)	
16 / 0.8 x 4.0 mm	

Type	Qty.	Order No.
WDU 6 SL	50	9537460000

Type	Qty.	Order No.
WDU 6 SL/EN	50	9537470000

Type	Qty.	Order No.
WQV 6/2	57 A 50	1052360000
WQV 6/10	57 A 20	1052260000
WAP 2.5-10	50	1050000000
WAP 16*35 WTW 2.5-10	20	1050100000
WEW 35/2	50	1061200000
WTA 5/1	6 A 25	1051260000
WAD 8 MC NE GE	48	1112950000
WAD 8 MC NE WS	48	1112940000
HBT 1,5 - 4,6 RT	100	1233340000
HBT 2,5 - 4,6 BL	100	1233330000
HBT 6,0 - 4,6 GE	100	1216230000
DEK 5/8 MC NE WS	800	1856740000
WS 12/6.5 MC NE WS	540	1609920000
WS 8/8 MM WS	500	2007170000
DEK 5/8 MM WS	500	2007130000

Type	Qty.	Order No.
WQV 6/2	57 A 50	1052360000
WQV 6/10	57 A 20	1052260000
WAP 2.5-10	50	1050000000
WAP 16*35 WTW 2.5-10	20	1050100000
WEW 35/2	50	1061200000
WTA 5/1	6 A 25	1051260000
WAD 8 MC NE GE	48	1112950000
WAD 8 MC NE WS	48	1112940000
HBT 1,5 - 4,6 RT	100	1233340000
HBT 2,5 - 4,6 BL	100	1233330000
HBT 6,0 - 4,6 GE	100	1216230000
DEK 5/8 MC NE WS	800	1856740000
WS 12/6.5 MC NE WS	540	1609920000
WS 8/8 MM WS	500	2007170000
DEK 5/8 MM WS	500	2007130000



Screw connection with clamping yoke technology (W-Series)

Feed-through terminal blocks

Universal range

A

WDU 10

10 mm²

WDU 10 IR

10 mm²

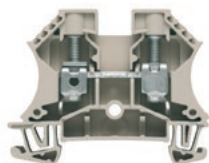

Width/Height/Depth	mm
max. current / max. cond. cross-section	A/mm ²
Max. clamping range	mm ²

9.9 x 60 x 46.5
76 / 16
1.31...16

9.9 x 60 x 46.5
76 / 16
1.31...16

Technical data

Rated data	
Rated voltage	V
Rated current	A
for wire cross-section	mm ²
Rated impulse withstand voltage / Pollution severity	
Gauge to IEC 60947-1 / UL 94 flammability rating	
Approvals	
Clamped conductors (H05V/H07V)	
Solid / Stranded	mm ²
Flexible / Flexible with ferrule	mm ²
Tightening torque / Clamping screw	Nm
Stripping length / Blade size	mm/-
2 conductors with same cross-section (H05V/H07V)	
Solid / Stranded	mm ²
Flexible / Flexible with ferrule	mm ²
Note	

IEC 60947-1				Ex eb II	C Gb	Ex	II 2 G D
IEC	UL	CSA	EN 60079-7				
1000	600	600	690				
57	65	65	57				
10	AWG 18...6	AWG 18...6	10 mm ²				
				8 kV / 3			
				B6 / V-0			
Rated connection		Further connection					
1.5...16 / 1.5...16							
1.5...16 / 1.5...16							
1.2...1.9 / (M 4)							
12 / 1.0 x 5.5 mm							
0.5...6 / 0.5...6							
0.5...6 / 0.5...6							

IEC 60947-1				Ex eb II	C Gb	Ex	II 2 G D
IEC	UL	CSA	EN 60079-7				
1000	600	600	690				
57	65	65	57				
10	AWG 18...6	AWG 18...6	10 mm ²				
				8 kV / 3			
				B6 / V-0			
Rated connection		Further connection					
1.5...16 / 1.5...16							
1.5...16 / 1.5...16							
1.5...1.8 / (M 4)							
12 / TX 15							

Ordering data

Version	
	dark beige
	Blue
	dark beige (combi clip-on foot TS 32/25)
	black (combi clip-on foot TS 32/25)
Note	

Type	Qty.	Order No.
WDU 10	50	1020300000
WDU 10 BL	50	1020380000

Type	Qty.	Order No.
WDU 10 IR	50	1393380000

Accessories

Screwable cross-connection	
	2-pole
	10-pole
End plate / Partition plate	
	dark beige
	Blue
	dark beige
	Blue
End bracket	
	dark beige
Testing / Checking	
	Standard
Cover	
	Blank, yellow
	Blank, white
Hak. Cable lugs	
Marking tags	
For detailed information on other accessories and application in the online catalogue	

Type	Qty.	Order No.	
WQV 10/2	76 A	50	1052560000
WQV 10/10	63 A	20	1052460000
WAP			
WAP 2.5-10		50	1050000000
WAP 2.5-10 BL		50	1050080000
WAP 16+35 WTW 2.5-10		20	1050100000
WAP 16+35 WTW 2.5-10 BL		20	1050180000
WEW			
WEW 35/2		50	1061200000
WTA			
WTA 3 WDU4	6 A	25	1632350000
WAD			
WAD 8 MC NE GE		48	1112950000
WAD 8 MC NE WS		48	1112940000
DEK			
DEK 5/5 MC NE WS	1000		1609801044
WS 12/6.5 MC NE WS	540		1609920000

Type	Qty.	Order No.	
WQV 10/2	76 A	50	1052560000
WQV 10/10	63 A	20	1052460000
WAP			
WAP 2.5-10		50	1050000000
WAP 2.5-10 BL		50	1050080000
WAP 16+35 WTW 2.5-10		20	1050100000
WAP 16+35 WTW 2.5-10 BL		20	1050180000
WEW			
WEW 35/2		50	1061200000
WTA			
WTA 5/1	6 A	25	1051260000
WAD			
WAD 8 MC NE GE		48	1112950000
WAD 8 MC NE WS		48	1112940000
DEK			
DEK 5/5 MC NE WS	1000		1609801044
WS 12/6.5 MC NE WS	540		1609920000

WDU 10/ZR

10 mm²

Additional connection on right 4 mm²

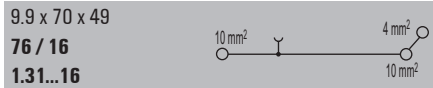
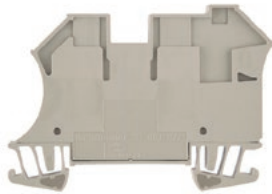

IEC 60947-7-1

IEC	UL	CSA	EN 60079-7
800	600	600	
57	65	65	
10	AWG 16...6	AWG 16...6	
8 kV / 3			
B6, A4 / V-0			

Rated connection		Further connection
1.5...16 / 1.5...16		0.5...6 / 1.5...4
1.5...16 / 1.5...16		0.5...4 / 0.5...4
1.2...1.9 / (M 4)		
12 / 0.6 x 3.5 mm		10 / 0.6 x 3.5 mm

0.5...6
1...6 / 1...6

Type	Qty.	Order No.
WDU 10/ZR	50	1042400000
WDU 10/ZR BL	50	1042480000

Type	Qty.	Order No.
WQV 10/2	76 A 50	1052560000
WQV 10/10	63 A 20	1052460000
WEW 35/2	50	1061200000
WTA 5/1	6 A 25	1051260000
WAD 8 MC NE GE	48	1112950000
WAD 8 MC NE WS	48	1112940000
HBT 1,5 - 4,6 RT	100	1233340000
HBT 2,5 - 4,6 BL	100	1233330000
HBT 6,0 - 4,6 GE	100	1216230000
DEK 5/5 MC NE WS	1000	1609801044
WS 12/6.5 MC NE WS	540	1609920000

WDU 10 SL

10 mm²

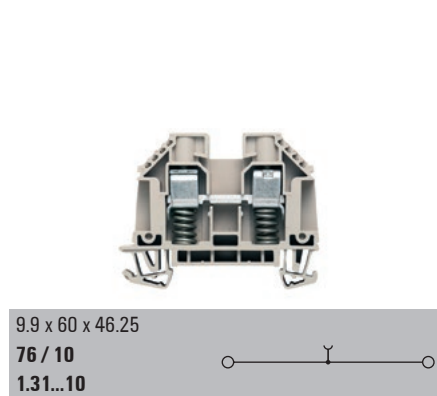

IEC 60947-7-1

IEC	UL	CSA	EN 60079-7
630	150	300	352
57	50	65	55
10	AWG 16...8	AWG 16...6	10 mm ²
6 kV / 2			
A5 / V-0			

Rated connection		Further connection
1.5...10 / 1.5...10		
1...6		
1.2...2.4 / (M 4)		
17 / 1.0 x 5.5 mm		

2.5...4 / 1...4

Type	Qty.	Order No.
WDU 10 SL	50	9537480000

Type	Qty.	Order No.
WQV 10/2	76 A 50	1052560000
WQV 10/10	63 A 20	1052460000
WAP 2.5-10	50	1050000000
WAP 2.5-10 BL	50	1050080000
WAP 16*35 WTW 2.5-10	20	1050100000
WEW 35/2	50	1061200000
WTA 5/1	6 A 25	1051260000
WAD 8 MC NE GE	48	1112950000
WAD 8 MC NE WS	48	1112940000
HBT 1,5 - 4,6 RT	100	1233340000
HBT 2,5 - 4,6 BL	100	1233330000
HBT 6,0 - 4,6 GE	100	1216230000
DEK 5/5 MC NE WS	1000	1609801044
WS 12/6.5 MC NE WS	540	1609920000

WDU 10 SL/EN

10 mm²

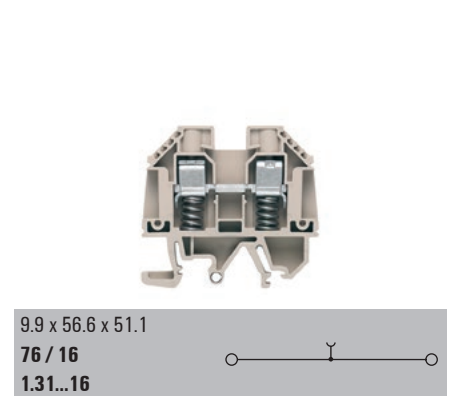

IEC 60947-7-1

IEC	UL	CSA	EN 60079-7
690	600	300	550
57	50	65	55
10	AWG 16...8	AWG 16...6	10 mm ²
6 kV / 3			
A6 / V-0			

Rated connection		Further connection
1.5...16 / 1.5...16		
1...6		
1.2...2.4 / (M 4)		
17 / 1.0 x 5.5 mm		

2.5...4 / 1...4

Type	Qty.	Order No.
WDU 10 SL/EN	50	9537490000
WDU 10 SL/EN SW	50	9537410000

Type	Qty.	Order No.
WQV 10/2	76 A 50	1052560000
WQV 10/10	63 A 20	1052460000
WAP 2.5-10	50	1050000000
WAP 2.5-10 BL	50	1050080000
WAP 16*35 WTW 2.5-10	20	1050100000
WEW 35/2	50	1061200000
WTA 5/1	6 A 25	1051260000
WAD 8 MC NE GE	48	1112950000
WAD 8 MC NE WS	48	1112940000
HBT 1,5 - 4,6 RT	100	1233340000
HBT 2,5 - 4,6 BL	100	1233330000
HBT 6,0 - 4,6 GE	100	1216230000
DEK 5/5 MC NE WS	1000	1609801044
WS 12/6.5 MC NE WS	540	1609920000

Screw connection with clamping yoke technology (W-Series)

Feed-through terminal blocks

Identically contoured design of 2.5 to 10 mm² with identical end plates and partitions. An unmatched combination of many advantages!
The compact terminals are impressive for their small size and rated cross-section capacity.

WDU 16

16 mm²

With peg for higher connection stability

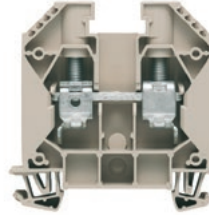

WDUB 16

16 mm²

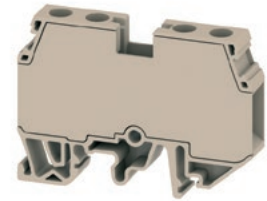

Width/Height/Depth	mm
max. current / max. cond. cross-section	A/mm ²
Max. clamping range	mm ²

11.9 x 60 x 62.5
101 / 25
0.82...25

9.9 x 65 x 47
76 / 16
0.5...16

Technical data

Rated data	
Rated voltage	V
Rated current	A
for wire cross-section	mm ²
Rated impulse withstand voltage / Pollution severity	
Gauge to IEC 60947-1 / UL 94 flammability rating	
Approvals	
Clamped conductors (H05V/H07V)	
Solid / Stranded	mm ²
Flexible / Flexible with ferrule	mm ²
Tightening torque / Clamping screw	Nm
Stripping length / Blade size	mm/-
2 conductors with same cross-section (H05V/H07V)	
Solid / Stranded	mm ²
Flexible / Flexible with ferrule	mm ²
Note	

IEC 60947-7-1

IEC	UL	CSA	EN 60079-7
1000	600	600	690
76	85	85	76
16	AWG 18...4	AWG 18...6	16 mm ²

8 kV / 3
B7 / V-0

Ex eb II
C Gb II 2 G D

DEMKO14ATEX1338U

Rated connection	Further connection
1.5...16 / 1.5...25	
1.5...25 / 1.5...16	
3...4 / (M 5)	
16 / 1.0 x 5.5 mm	
1.5...6 / 1.5...6	
1.5...6 / 1.5...6	

IEC 60947-7-1

IEC	UL	CSA	EN 60079-7
1000	600		
76	65		
16			

8 kV / 3
B6 / V-0

Rated connection	Further connection
0.5...16 / 0.5...16	
0.5...10 / 0.5...10	
1.2...1.9 / (M 4)	
20 / 0.8 x 4.0 mm	

Ordering data

Version	
	dark beige
	without peg / dark beige
	with peg / blue
	with peg / dark beige
Note	

Type	Qty.	Order No.
WDU 16	50	1020400000
WDU 16 BL	50	1020480000
WDU 16/ZA	50	1028900000

Type	Qty.	Order No.
WDUB 16	20	2868370000

Accessories

Screwable cross-connection	
	2-pole
	10-pole
End plate / Partition plate	
	dark beige
	Blue
End bracket	
	dark beige, screwable
	dark beige
Cover	
	black/yellow
	white
	Blank, yellow
	Blank, white
Marking tags	

Type	Qty.	Order No.
WQV 16/2	101 A 50	1053260000
WQV 16/10	101 A 10	1053360000
WAP 16+35 WTW 2.5-10	20	1050100000
WAP 16+35 WTW 2.5-10 BL	20	1050180000
WEW 35/1	50	1059000000
WAD 12 MC B GE/SW	32	2445090000
WAD 12 MC NE WS	32	2445070000
DEK 5/5 MC NE WS	1000	1609801044
WS 12/6.5 MC NE WS	540	1609920000

Type	Qty.	Order No.
WQV 10/2	76 A 50	1052560000
WQV 10/10	63 A 20	1052460000
WEW 35/2	50	1061200000
WAD 8 MC B GE/SW	48	1120470000
WAD 8 MC NE WS	48	1112940000
DEK 5/5 MC NE WS	1000	1609801044
WS 12/5 MC NE WS	720	1609860000

For detailed information on other accessories and application in the online catalogue

WDU 16 IR

16 mm²

WDU 16N

16 mm²

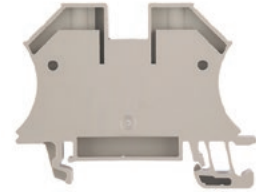
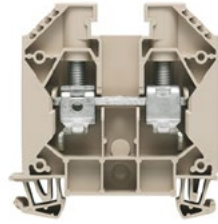

Suitable for power distribution
Compact design

Width/Height/Depth	mm
max. current / max. cond. cross-section	A/mm ²
Max. clamping range	mm ²

11.9 x 60 x 62.5
101 / 25
0.82...25

12 x 60 x 46.5
101 / 25
1.5...25

Technical data

Rated data	
Rated voltage	V
Rated current	A
for wire cross-section	mm ²
Rated impulse withstand voltage / Pollution severity	
Gauge to IEC 60947-1 / UL 94 flammability rating	
Approvals	
Clamped conductors (H05V/H07V)	
Solid / Stranded	mm ²
Flexible / Flexible with ferrule	mm ²
Tightening torque / Clamping screw	Nm
Stripping length / Blade size	mm/-
2 conductors with same cross-section (H05V/H07V)	
Solid / Stranded	mm ²
Flexible / Flexible with ferrule	mm ²
Note	

IEC 60947-7-1

Ex eb II
C Gb II 2 G D

IEC	UL	CSA	EN 60079-7
1000	600	600	690
76	85	85	76
16	AWG 18...4	AWG 18...6	16 mm ²
8 kV / 3			
B7 / V-0			
DEMKO14ATEX1338U			
Rated connection		Further connection	
1.5...16 / 1.5...25			
1.5...25 / 1.5...16			
3...4 / (M 5)			
16 / TX 15			
1.5...6 / 1.5...6			
1.5...6 / 1.5...6			

IEC 60947-7-1

IEC	UL	CSA	EN 60079-7
690	600	300	
76	70	70	
16	AWG 14...6	AWG 14...6	
8 kV / 3			
B7 / V-0			
Rated connection		Further connection	
1.5...16 / 1.5...25			
1.5...16 / 1.5...16			
1.2...2.4 / (M 4)			
12 / 1.0 x 5.5 mm			
1.5...4 / 1.5...4			

Ordering data

Version	
	dark beige
	Blue
Note	

Type	Qty.	Order No.
WDU 16 IR	50	1393390000

Type	Qty.	Order No.
WDU 16N	50	1036100000
WDU 16N BL	50	1036180000

Accessories

Screwable cross-connection	
	2-pole
	10-pole
	4-pole
End plate / Partition plate	
	dark beige
	Blue
End bracket	
	dark beige, screwable
	dark beige
Cover	
	black/yellow
	white
Marking tags	
Testing / Checking	
	Standard

Type	Qty.	Order No.
WQV 16/2	101 A 50	1053260000
WQV 16/10	101 A 10	1053360000
End plate / Partition plate		
WAP 16+35 WTW 2.5-10	20	1050100000
WAP 16+35 WTW 2.5-10 BL	20	1050180000
End bracket		
WEW 35/1	50	1059000000
Cover		
WAD 12 MC B GE/SW	32	2445090000
WAD 12 MC NE WS	32	2445070000
Marking tags		
DEK 5/5 MC NE WS	1000	1609801044
WS 12/5 MC NE WS	720	1609860000
Testing / Checking		

Type	Qty.	Order No.
WQV 16N/2	76 A 50	1636560000
WQV 16N/4	76 A 50	1636580000
WTW EN	20	1058800000
End bracket		
WEW 35/2	50	1061200000
Cover		
WAD 12 MC B GE/SW	32	2445090000
WAD 12 MC NE WS	32	2445070000
Marking tags		
DEK 5/5 MC NE WS	1000	1609801044
WS 10/12 MC NE WS	300	1905970000
Testing / Checking		
WTA 2 WDU2.5-10	6 A 25	1632320000

For detailed information on other accessories and application in the online catalogue



Screw connection with clamping yoke technology (W-Series)

Feed-through terminal blocks

Identically contoured design of 2.5 to 10 mm² with identical end plates and partitions. An unmatched combination of many advantages!
The compact terminals are impressive for their small size and rated cross-section capacity.

Universal range

A

Width/Height/Depth	mm
max. current / max. cond. cross-section	A/mm ²
Max. clamping range	mm ²

Technical data

Rated data	
Rated voltage	V
Rated current	A
for wire cross-section	mm ²
Rated impulse withstand voltage / Pollution severity	
Gauge to IEC 60947-1 / UL 94 flammability rating	
Approvals	
Clamped conductors (H05V/H07V)	
Solid / Stranded	mm ²
Flexible / Flexible with ferrule	mm ²
Tightening torque / Clamping screw	Nm
Stripping length / Blade size	mm/-
2 conductors with same cross-section (H05V/H07V)	
Solid / Stranded	-
Flexible / Flexible with ferrule	mm ²
Note	

Ordering data

Version	
	without peg / dark beige
	with peg / blue
	with peg / dark beige
Note	

Accessories

Screwable cross-connection	
	2-pole
	10-pole
	4-pole
End plate / Partition plate	
	dark beige
	Blue
End bracket	
	dark beige, screwable
	dark beige
Cover	
	black/yellow
	white
	With lightning flash symbol
Marking tags	

For detailed information on other accessories and application in the online catalogue

WDU 35

35 mm²

Clamping screw / spigot for good connection stability

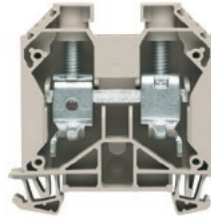

16 x 60 x 62.5
150 / 50
2.5...50

IEC 60947-7-1 Ex eb II C Gb II 2 G D

IEC	UL	CSA	EN 60079-7
1000	1000	600	690
125	150	150	115
35	AWG 12...0	AWG 12...NaN	35 mm ²

8 kV / 3
B8 / V-0

DEMKO14ATEX1338U

Rated connection	Further connection
2.5...16 / 2.5...50	
2.5...35 / 2.5...35	
4...5 / (M 6)	
18 / 6.5 x 1.2 mm	

/ 16...16
2.5...16 / 2.5...16

Type	Qty.	Order No.
WDU 35	40	1020500000
WDU 35 BL	40	1020580000
WDU 35/ZA	40	1028800000

Type	Qty.	Order No.
WQV 35/2	138 A 50	1053060000
WQV 35/10	112 A 10	1053160000

WAP 16+35 WTW 2.5-10	20	1050100000
WAP 16+35 WTW 2.5-10 BL	20	1050180000

WEW 35/1	50	1059000000
----------	----	------------

WAD 12 MC B GE/SW	32	2445090000
WAD 12 MC NE WS	32	2445070000

DEK 5/5 MC NE WS	1000	1609801044
WS 12/6.5 MC NE WS	540	1609920000

WDU 35 IR

35 mm²

Clamping screw / spigot for good connection stability

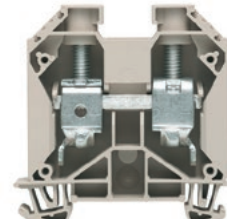

16 x 60 x 62.5
150 / 50
2.5...50

IEC 60947-7-1 Ex eb II C Gb II 2 G D

IEC	UL	CSA	EN 60079-7
1000	1000		690
125	150		115
35	AWG 12...0		35 mm ²

8 kV / 3
B8 / V-0

DEMKO14ATEX1338U

Rated connection	Further connection
2.5...16 / 2.5...50	
2.5...35 / 2.5...35	
4...5 / (M 6)	
18 / TX 20	

/ 16...16
2.5...16 / 2.5...16

Type	Qty.	Order No.
WDU 35 IR	40	1393400000

Type	Qty.	Order No.
WQV 35/2	138 A 50	1053060000
WQV 35/10	112 A 10	1053160000

WAP 16+35 WTW 2.5-10	20	1050100000
WAP 16+35 WTW 2.5-10 BL	20	1050180000

WEW 35/1	50	1059000000
----------	----	------------

WAD 12 MC B GE/SW	32	2445090000
WAD 12 MC NE WS	32	2445070000

DEK 5/5 MC NE WS	1000	1609801044
WS 12/5 MC NE WS	720	1609860000

For detailed information on other accessories and application in the online catalogue

WDU 35 IK

35 mm²

Hexagonal socket / spigot for good connection stability

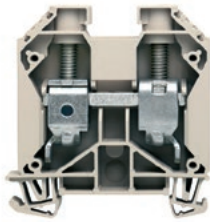

16 x 60 x 62.5
150 / 50
2.5...50

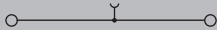

IEC 60947-7-1 Ex eb II C Gb II 2 G D

IEC	UL	CSA	EN 60079-7
1000	600	600	690
125	150	150	115
35	AWG 12...NaN	AWG 12...NaN	35 mm ²

8 kV / 3

B8 / V-0

DEMKO14ATEX1338U

Rated connection	Further connection
2.5...16 / 2.5...50	
2.5...35 / 2.5...35	
4...6 / (M 6)	
18 / S4 (DIN 6911)	
/ 16...16	
2.5...16 / 2.5...16	

Type	Qty.	Order No.
WDU 35/IK	25	1020600000
WDU 35/IK BL	25	1020680000
WDU 35/IK/ZA	25	1029000000

Type	Qty.	Order No.
WQV 35/2	138 A 50	1053060000
WQV 35/10	112 A 10	1053160000
WAP 16+35 WTW 2.5-10	20	1050100000
WAP 16+35 WTW 2.5-10 BL	20	1050180000
WEW 35/1	50	1059000000
WAD 12 MC B GE/SW	32	2445090000
WAD 12 MC NE WS	32	2445070000
DEK 5/5 MC NE WS	1000	1609801044
WS 12/6.5 MC NE WS	540	1609920000

WDU 35N

35 mm²

Suitable for power distribution
Compact design



16 x 66 x 50.5
150 / 50
2.5...50

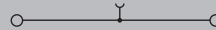

IEC 60947-7-1 Ex eb II C Gb II 2 G D

IEC	UL	CSA	EN 60079-7
500	1000		352
125	150		110
35	AWG 12...0	AWG 12...2	35 mm ²

6 kV / 3

B8 / V-0

DEMKO14ATEX1338U

Rated connection	Further connection
2.5...16 / 2.5...50	
2.5...35 / 2.5...35	
4...5 / (M 6)	
18 / 6.5 x 1.2 mm	
2.5...6 / 2.5...6	

Type	Qty.	Order No.
WDU 35N	20	1040400000
WDU 35N BL	20	1040480000

Type	Qty.	Order No.
WQV 35N/2	125 A 20	1079200000
WQV 35N/4	125 A 20	1079400000
WTW EN	20	1058800000
WEW 35/2	50	1061200000
WAD 16N GE BED	50	1083600000
DEK 5/5 MC NE WS	1000	1609801044
WS 12/6.5 MC NE WS	540	1609920000



Screw connection with clamping yoke technology (W-Series)

Feed-through terminal blocks

Universal range

A

WDU 50N

50 mm²

Compact design



WDU 50N IR

50 mm²

Six-lobe socket



Width/Height/Depth	mm
max. current / max. cond. cross-section	A/mm ²
Max. clamping range	mm ²

18.5 x 70 x 69.6	
192 / 70	
10...70	

18.5 x 70 x 69.6	
192 / 70	
10...70	

Technical data

Rated data	
Rated voltage	V
Rated current	A
for wire cross-section	mm ²
Rated impulse withstand voltage / Pollution severity	
Gauge to IEC 60947-1 / UL 94 flammability rating	
Approvals	
Clamped conductors (H05V/H07V)	
Solid / Stranded	mm ²
Flexible / Flexible with ferrule	mm ²
Tightening torque / Clamping screw	Nm
Stripping length / Blade size	mm/-
2 conductors with same cross-section (H05V/H07V)	
Solid / Stranded	-
Flexible / Flexible with ferrule	mm ²
Note	

IEC 60947-1	Ex eb II C Gb		II 2 G D
IEC	UL	CSA	EN 60079-7
1000	600	600	690
150	150	150	126
50	AWG 10...0	AWG 8...0	50 mm ²
8 kV / 3 B10 / V-0			
DEMKO14ATEX1338U			
Rated connection	Further connection		
10...16 / 10...70			
10...50			
3.5...6 / (M 6)			
24 / S4 (DIN 6911)			
/ 6...16			
6...16 / 6...16			

IEC 60947-1	Ex eb II C Gb		II 2 G D
IEC	UL	CSA	EN 60079-7
1000			690
150			126
50			50 mm ²
8 kV / 3 B10 / V-0			
DEMKO14ATEX1338U			
Rated connection	Further connection		
10...16 / 10...70			
10...50			
3...6 / (M 6)			
24 / TX 20			
/ 6...16			
6...16 / 6...16			

Ordering data

Version	dark beige Blue
Note	

Type	Qty.	Order No.
WDU 50N	10	1820840000
WDU 50N BL	10	1820850000

Type	Qty.	Order No.
WDU 50N IR	10	1186630000

Accessories

Screwable cross-connection	
2-pole	
3-pole	
4-pole	
End bracket	
	dark beige, screwable
Cover	
	With lightning flash symbol
Additional connection	
	10 mm ²
Marking tags	
Screwdriver	
	Standard

Type	Qty.	Order No.
WQV 50N/2	150 A 5	1834060000
WQV 50N/3	150 A 5	1834070000
WQV 50N/4	150 A 5	1834080000
WEW 35/1	50	1059000000
WAD 20 GE WSD	10	9512260000
WZAD 50N	41 A 5	1872720000
DEK 5/5 MC NE WS	1000	1609801044
WS 12/6.5 MC NE WS	540	1609920000
SKS 2,0-8,0 MR	1	9008870000

Type	Qty.	Order No.
WQV 50N/2	150 A 5	1834060000
WQV 50N/3	150 A 5	1834070000
WQV 50N/4	150 A 5	1834080000
WEW 35/1	50	1059000000
WAD 20 GE WSD	10	9512260000
WZAD 50N	41 A 5	1872720000
DEK 5/5 MC NE WS	1000	1609801044
WS 12/6.5 MC NE WS	540	1609920000
TH-S 9-40	1	9008880000

For detailed information on other accessories and application in the online catalogue

WDU 70N

70 mm²

Compact design

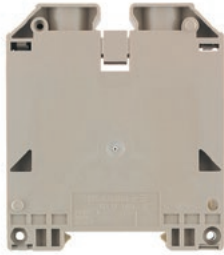

20.5 x 75 x 85
232 / 95
16...95

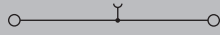

Ex eb II
C Gb II 2 G D

IEC 60947-7-1

IEC	UL	CSA	EN 60079-7
1000	600	600	690
192	150	150	184
70	AWG 6...0	AWG 6...0	70 mm ²

8 kV / 3
B11 / V-0



DEMKO14ATEX1338U

Rated connection	Further connection
16...16 / 16...95	
16...70 / 16...50	
8...12 / (M 8)	
22 / S6 (DIN 6911)	
/ 10...25	
10...25 / 6...25	

Type	Qty.	Order No.
WDU 70N/35	10	9512190000
WDU 70N/35 BL	10	9512420000

Type	Qty.	Order No.
WQV 70N/2	192 A	5 9512240000
WQV 70N/3	192 A	5 9512250000
WQV 70N/4	192 A	5 9531290000
WEW 35/1	50	1059000000
WAD 20 GE WSD	10	9512260000
WZAD 70N	41 A	5 1964830000
DEK 5/5 MC NE WS	1000	1609801044
WS 12/6.5 MC NE WS	540	1609920000
SKS 2,0-8,0 MR	1	9008870000

WDU 70N/35 IR

70 mm²

Compact design

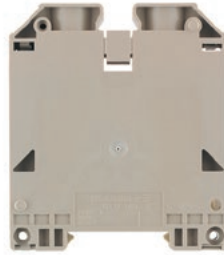

20.5 x 75 x 85
232 / 95
16...95

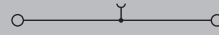

Ex eb II
C Gb II 2 G D

IEC 60947-7-1

IEC	UL	CSA	EN 60079-7
1000	600		
192	150		
70	AWG 6...0		

8 kV / 3
B11 / V-0



Rated connection	Further connection
16...16 / 16...95	
16...70 / 16...50	
8...12 / (M 8)	
22 / TX 40	

Type	Qty.	Order No.
WDU 70N/35 IR	10	1393420000

Type	Qty.	Order No.
WQV 70N/2	192 A	5 9512240000
WQV 70N/3	192 A	5 9512250000
WQV 70N/4	192 A	5 9531290000
WEW 35/1	50	1059000000
WAD 20 GE WSD	10	9512260000
WZAD 70N	41 A	5 1964830000
DEK 5/5 MC NE WS	1000	1609801044
WS 12/5 MC NE WS	720	1609860000
THS 9-40	1	9008880000

WDU 95N/120N

120 mm²

Compact design



27 x 91 x 90
290 / 150
16...150

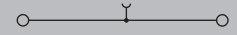

Ex eb II
C Gb II 2 G D

IEC 60947-7-1

IEC	UL	CSA	EN 60079-7
1000	1000	1000	880
269	228	220	221
120	AWG 4...250	AWG 4...0	120 mm ²

8 kV / 3
B13 / V-0



DEMKO14ATEX1338U

Rated connection	Further connection
16...16 / 16...150	
16...120	
12...20 / (M 10)	
27 / S6 (DIN 6911)	
35...10 / 10...35	
16...35 / 10...35	

Type	Qty.	Order No.
WDU 95N/120N	5	1820550000
WDU 95N/120N BL	5	1820560000

Type	Qty.	Order No.
WQV 95N/120N/2	269 A	5 1826890000
WQV 95N/120N/3	269 A	5 1826900000
WQV 95N/120N/4	269 A	5 1826910000
WEW 35/1	50	1059000000
WAD 20 GE WSD	10	9512260000
WZAD 95N/120N	41 A	5 1859580000
DEK 5/5 MC NE WS	1000	1609801044
WS 12/6.5 MC NE WS	540	1609920000
SKS 2,0-8,0 MR	1	9008870000



Screw connection with clamping yoke technology (W-Series)

Feed-through terminal blocks

WDU 240

240 mm²

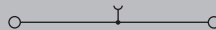

Width/Height/Depth	mm
max. current / max. cond. cross-section	A/mm ²
Max. clamping range	mm ²

36 x 100 x 123.7
415 / 240
70...240

Technical data

Rated data	
Rated voltage	V
Rated current	A
for wire cross-section	mm ²
Rated impulse withstand voltage / Pollution severity	
Gauge to IEC 60947-1 / UL 94 flammability rating	
Approvals	
Clamped conductors (H05V/H07V)	
Solid / Stranded	-
Flexible / Flexible with ferrule	mm ²
Tightening torque / Clamping screw	Nm
Stripping length / Blade size	mm/-
2 conductors with same cross-section (H05V/H07V)	
Solid / Stranded	-
Flexible / Flexible with ferrule	mm ²
Note	

IEC 60947-7-1 Ex e II II 2 G D

IEC	UL	CSA	EN 60079-7
1000	600	600	1100
415	380	400	350
240		AWG 0...500	240 mm ²
8 kV / 3			
B15 / V-0			
CE		KEMA01ATEX2186U	
Rated connection		Further connection	
/ 70...240			
70...240 / 70...185			
25...30 / (M 10)			
40 / S8 (DIN 6911)			
/ 35...95			
50...95 / 35...50			
Note			

Ordering data

Version	
	dark beige
	Blue
Note	

Type	Qty.	Order No.
WDU 240	2	1802780000
WDU 240 BL	2	1822210000
Note		

Accessories

Screwable cross-connection	
	2-pole
	3-pole
	4-pole
End bracket	
	dark beige, screwable
Cover	
	With lightning flash symbol
Additional connection	
	10 mm ²
Marking tags	
Screwdriver	
	Standard

Type	Qty.	Order No.
WQB 240/2	320 A 5	1802790000
WQB 240/3	320 A 5	1802800000
WEW 35/1	50	1059000000
WZAD 240	57 A 5	1802810000
DEK 5/5 MC NE WS	1000	1609801044
WS 12/6.5 MC NE WS	540	1609920000
SKS 2,0-8,0 MR	1	9008870000

For detailed information on other accessories and application in the online catalogue





Leaf clamp

Leaf clamp conductor connection for large cross-sections

It is no longer the case that conductors with large cross-sections have to be forced into the clamping point. Instead, they can now be easily laid in the modular terminal.

In addition to the individual form, every type of terminal can also be supplied in the form of 3-, 4- and 5-pole blocks. All the blocks are permanently screwed together and therefore guarantee additional rigidity. Direct mounting is possible thanks to the elongated holes on the underside of the terminals. Terminal blocks can be screwed directly to mounting plates with a 25 mm pitch.

The other advantages are:

- Constant force transfer through selfadjusting connection system
- Mounting in any direction
- Electric shock protection (finger-proof) to German standard VBG 4, also with cross-connections
- Extremely resistant to distortion

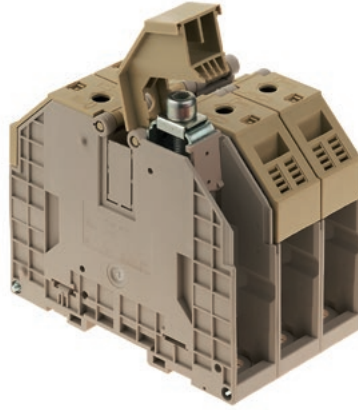

Open cover and remove screw assembly

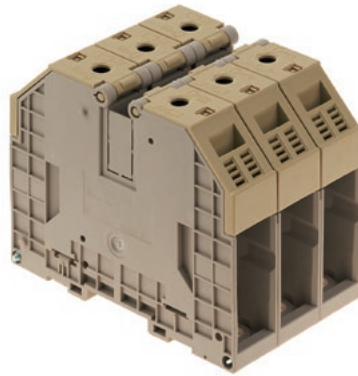

Close cover and tighten screw with Allen key

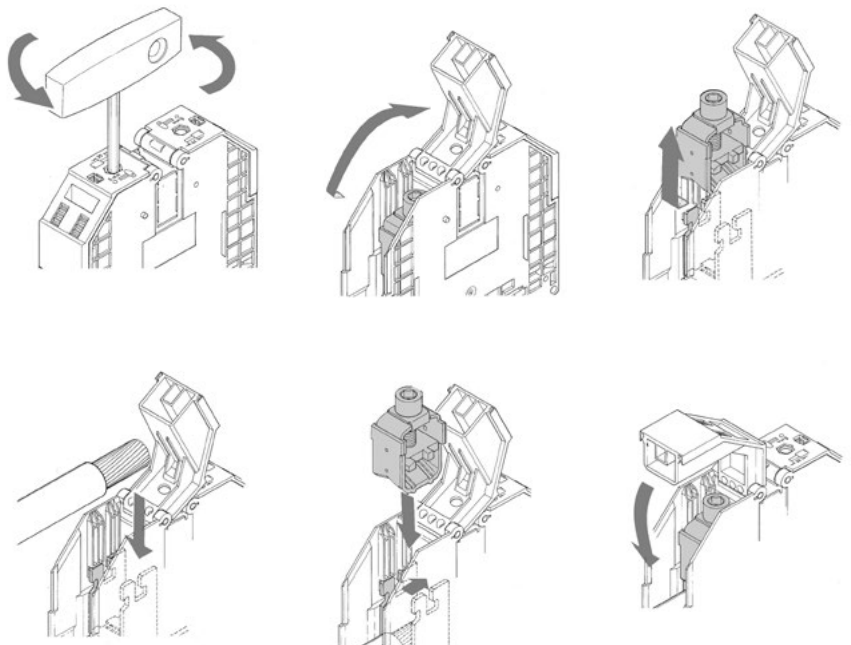

WDU 70/95

95 mm²

Conductor can be inserted from above / leaf spring

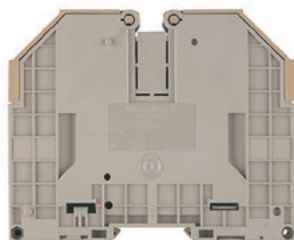

Width/Height/Depth	mm
max. current / max. cond. cross-section	A/mm ²
Max. clamping range	mm ²

27 x 132 x 107
232 / 120
13.3...120

Technical data

Rated data	
Rated voltage	V
Rated current	A
for wire cross-section	mm ²
Rated impulse withstand voltage / Pollution severity	
Gauge to IEC 60947-1 / UL 94 flammability rating	
Approvals	
Clamped conductors (H05V/H07V)	
Solid / Stranded	mm ²
Flexible / Flexible with ferrule	mm ²
Tightening torque / Clamping screw	Nm
Stripping length / Blade size	mm/-
2 conductors with same cross-section (H05V/H07V)	
Solid / Stranded	-
Flexible / Flexible with ferrule	mm ²
Note	

Ordering data

Version	
	dark beige
	Blue
Note	

Accessories

Screwable cross-connection	
	2-pole
	3-pole
End bracket	dark beige, screwable
Cover	With lightning flash symbol Blank, white
Additional connection	4mm ²
Marking tags	
Screwdriver	Standard

For detailed information on other accessories and application in the online catalogue

WDU 120/150

120 mm²

Conductor can be inserted from above / leaf spring

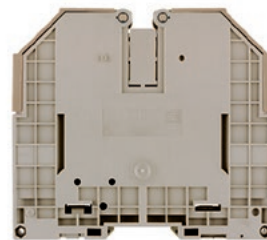

32 x 132 x 117
309 / 150
33.63...150

IEC 60947-1 Ex eb II C Gb Ex II 2 G D

IEC	UL	CSA	EN 60079-7
1000	1000	600	1100
269	225	285	265
120	AWG 2...250	AWG 2...250	150 mm ²
8 kV / 3			
B13 / V-0			

DEMKO14ATEX1338U

Rated connection	Further connection
/ 35...150	
35...150 / 35...50	
10...20 / (M 10)	
35 / S6 (DIN 6911)	
/ 35...70	
35...70 / 35...70	
Note	

Type	Qty.	Order No.
WDU 120/150	10	1024500000
WDU 120/150 BL	10	1024580000

Type	Qty.	Order No.
WQV 120/2	269 A 5	1063300000
WQV 120/3	292 A 5	1063400000
WEW 35/1	50	1059000000
WAD 27 M. BL	10	1062860000
WAD 27 NEUTRAL	10	1062960000
WZAD120	10	1066100000
DEK 5/5 MC NE WS	1000	1609801044
WS 12/6.5 MC NE WS	540	1609920000
SKS 2,0-8,0 MR	1	9008870000

For detailed information on other accessories and application in the online catalogue



WDK 2.5 ZQV

2.5 mm²

Plug-in cross-connection



5.1 x 69 x 62.5
32 / 4
0.05...4



IEC 60947-7-1 Ex eb II C Gb II 2 G D

IEC	UL	CSA	EN 60079-7
400	300	300	275
24	20	25	21
2.5	AWG 22...12	AWG 26...12	4 mm ²

6 kV / 3
A3 / V-0

DEMKO15ATEX1346U

Rated connection	Further connection
0.5...4 / 1.5...4	
0.5...4 / 0.5...2.5	
0.4...0.6 / (M 2.5)	
10 / 0.6 x 3.5 mm	

0.5...1.5 / 0.5...1.5

Type	Qty.	Order No.
WDK 2.5 ZQV	100	1041100000
WDK 2.5 ZQV BL	100	1041180000

Type	Qty.	Order No.
ZQV 2.5N/2	24 A 60	1527540000
ZQV 2.5N/10	24 A 20	1527690000
WAP WDK2.5	20	1059100000
WAP WDK2.5 BL	20	1059180000
WTW EN	20	1058800000
WEW 35/2	50	1061200000
WAD 4 GE BED	50	1072000000
WAD 4 WS	50	1072100000
DEK 5/5 MC NE WS	1000	1609801044
WS 8/5 MC NE WS	720	1640740000
DEK 5/5 MM WS	800	2007110000

WDK 2.5 V

2.5 mm²

Both levels at one potential

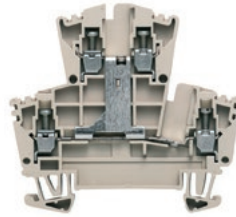

5.1 x 69.5 x 62.5
32 / 4
0.05...4

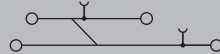

IEC 60947-7-1 Ex eb II C Gb II 2 G D

IEC	UL	CSA	EN 60079-7
400	600	300	275
24	20	10	24
2.5	AWG 30...12	AWG 26...12	4 mm ²

6 kV / 3
A3 / V-0

DEMKO15ATEX1346U

Rated connection	Further connection
0.5...4 / 1.5...4	
0.5...4 / 0.5...2.5	
0.4...0.6 / (M 2.5)	
10 / 0.6 x 3.5 mm	

0.5...1.5 / 0.5...1.5

Type	Qty.	Order No.
WDK 2.5V	50	1022300000
WDK 2.5V BL	50	1022380000

Type	Qty.	Order No.
WQV 2.5/2	32 A 50	1053660000
WQV 2.5/10	32 A 20	1054460000
WAP WDK2.5	20	1059100000
WAP WDK2.5 BL	20	1059180000
WTW EN	20	1058800000
WEW 35/2	50	1061200000
WAD 4 GE BED	50	1072000000
WAD 4 WS	50	1072100000
DEK 5/5 MC NE WS	1000	1609801044
WS 8/5 MC NE WS	720	1640740000
DEK 5/5 MM WS	800	2007110000

WDK 2.5 V ZQV

2.5 mm²



5.1 x 69.5 x 62.5
32 / 4
0.05...4



IEC 60947-7-1 Ex eb II C Gb II 2 G D

IEC	UL	CSA	EN 60079-7
400	600	600	275
24	20	25	21
2.5	AWG 30...12	AWG 30...12	4 mm ²

/ 3
A3 / V-0

DEMKO15ATEX1346U

Rated connection	Further connection
0.5...4 / 0.5...4	
0.5...4 / 0.5...2.5	
/ (M 2.5)	
10 / 0.6 x 3.5 mm	

0.5...1.5 / 0.5...1.5

Type	Qty.	Order No.
WDK 2.5V ZQV	50	2739600000
WDK 2.5V ZQV BL	50	2739610000
WDK 2.5V ZQV OR	50	2732600000

Type	Qty.	Order No.
ZQV 2.5N/2	24 A 60	1527540000
ZQV 2.5N/10	24 A 20	1527690000
WAP WDK2.5	20	1059100000
WAP WDK2.5 BL	20	1059180000
WTW EN	20	1058800000
WEW 35/2	50	1061200000
WAD 4 GE BED	50	1072000000
WAD 4 WS	50	1072100000
DEK 5/5 MC NE WS	1000	1609801044
WS 8/5 MC NE WS	720	1640740000
DEK 5/5 MM WS	800	2007110000



Screw connection with clamping yoke technology (W-Series)

Feed-through terminal blocks

Universal range

A

WDK 2.5 DU-PE

2.5 mm²

Lower level earthed on terminal rail



WDK 2.5N

2.5 mm²

Plug-in cross-connection
Compact design

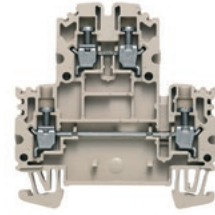

Width/Height/Depth	mm
max. current / max. cond. cross-section	A/mm ²
Max. clamping range	mm ²

5.1 x 69.5 x 62.5	
32 / 4	
0.05...4	

5.1 x 61 x 62	
28 / 4	
0.05...4	

Technical data

Rated data	
Rated voltage	V
Rated current	A
for wire cross-section	mm ²
Rated impulse withstand voltage / Pollution severity	
Gauge to IEC 60947-1 / UL 94 flammability rating	
Approvals	
Clamped conductors (H05V/H07V)	
Solid / Stranded	mm ²
Flexible / Flexible with ferrule	mm ²
Tightening torque / Clamping screw	Nm
Stripping length / Blade size	mm/-
2 conductors with same cross-section (H05V/H07V)	
Solid / Stranded	-
Flexible / Flexible with ferrule	mm ²
Note	

IEC 60947-7-1 (-7-2) Ex eb II C Gb II 2 G D

IEC	UL	CSA	EN 60079-7
400	300	300	275
24	20	20	23
2.5	AWG 22...12	AWG 22...12	4 mm ²
6 kV / 3			
A3 / V-0			

DEMKO15ATEX1346U

Rated connection	Further connection
0.5...4 / 1.5...4	
0.5...4 / 0.5...2.5	
0.4...0.6 / (M 2.5)	
10 / 0.6 x 3.5 mm	

IEC 60947-7-1 Ex eb II C Gb II 2 G D

IEC	UL	CSA	EN 60079-7
800	600	300	550
24	20	20	21
2.5	AWG 26...12	AWG 26...12	4 mm ²
8 kV / 3			
A3 / V-0			

DEMKO15ATEX1346U

Rated connection	Further connection
0.5...4 / 1.5...4	
0.5...4 / 2.5...2.5	
0.4...0.6 / (M 2.5)	
8 / 0.6 x 3.5 mm	

Ordering data

Version	
	dark beige
	Blue
Note	

Type	Qty.	Order No.
WDK 2.5DU-PE	50	1036400000

Type	Qty.	Order No.
WDK 2.5N	50	1041600000
WDK 2.5N BL	50	1041680000

Accessories

Screwable cross-connection	
	2-pole
	10-pole
End plate / Partition plate	
	dark beige
	Blue
	dark beige
End bracket	
	dark beige
Cover	
	With lightning flash symbol
	Blank, white
Marking tags	
Plug-in cross-connection	
	2-pole
	10-pole

Type	Qty.	Order No.
WQV 2.5/2	32 A 50	1053660000
WQV 2.5/10	32 A 20	1054460000
WAP WDK2.5	20	1059100000
WAP WDK2.5 BL	20	1059180000
WTW EN	20	1058800000
WEW 35/2	50	1061200000
WAD 4 GE BED	50	1072000000
WAD 4 WS	50	1072100000
DEK 5/5 MC NE WS	1000	1609801044
WS 8/5 MC NE WS	720	1640740000
DEK 5/5 MM WS	800	2007110000

Type	Qty.	Order No.
WAP WDK2.5/4 N	20	1084000000
WAP WDK2.5/4 N BL	20	1084080000
WTW EN	20	1058800000
WEW 35/2	50	1061200000
DEK 5/5 MC NE WS	1000	1609801044
WS 8/5 MC NE WS	720	1640740000
DEK 5/5 MM WS	800	2007110000
ZQV 2.5N/2	24 A 60	1527540000
ZQV 2.5N/10	24 A 20	1527690000

For detailed information on other accessories and application in the online catalogue

WDK 2.5N V

2.5 mm²

Both levels at one potential
Compact design

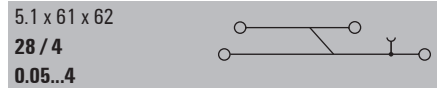
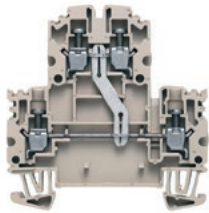

IEC 60947-7-1 Ex eb II C Gb II 2 G D

IEC	UL	CSA	EN 60079-7
800	600	300	550
24	20	20	24
2.5	AWG 26...12	AWG 26...12	4 mm ²

8 kV / 3
A3 / V-0

DEMKO15ATEX1346U

Rated connection	Further connection
0.5...4 / 1.5...4	
0.5...4 / 0.5...2.5	
0.4...0.6 / (M 2.5)	
8 / 0.6 x 3.5 mm	

0.5...1.5 / 0.5...1.5

Type	Qty.	Order No.
WDK 2.5N V	50	1041610000

Type	Qty.	Order No.
WAP WDK2.5/4 N	20	1084000000
WAP WDK2.5/4 N BL	20	1084080000
WTW EN	20	1058800000
WEW 35/2	50	1061200000
DEK 5/5 MC NE WS	1000	1609801044
WS 8/5 MC NE WS	720	1640740000
DEK 5/5 MM WS	800	2007110000
ZQV 2.5N/2	24 A 60	1527540000
ZQV 2.5N/10	24 A 20	1527690000

WDK 2.5 / 800 V

2.5 mm²

Rated voltage 800 V

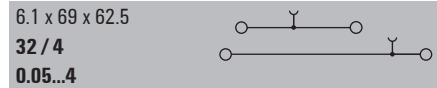
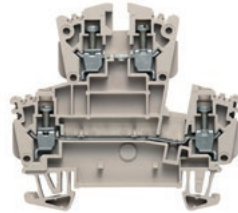

IEC 60947-7-1 Ex eb II C Gb II 2 G D

IEC	UL	CSA	EN 60079-7
800			550
24			22
2.5		AWG 26...12	4 mm ²

8 kV / 3
A3 / V-0

DEMKO15ATEX1346U

Rated connection	Further connection
0.5...4 / 1.5...4	
0.5...4 / 0.5...2.5	
0.4...0.6 / (M 2.5)	
10 / 0.6 x 3.5 mm	

0.5...1.5 / 0.5...1.5

Type	Qty.	Order No.
WDK 2.5/EX	100	1029100000

Type	Qty.	Order No.
Q 2 AKZ4SS	32 A 50	0369000000
Q 10 AKZ4SS	32 A 20	0369300000
WAP WDK2.5	20	1059100000
WAP WDK2.5 BL	20	1059180000
WAP 16*35 WTW 2.5-10	20	1050100000
WEW 35/2	50	1061200000
WAD 4 GE BED	50	1072000000
WAD 4 WS	50	1072100000
DEK 5/6 MC NE WS	1000	1609820000
WS 8/5 MC NE WS	720	1640740000
DEK 5/5 MM WS	800	2007110000

WDK 2.5N DU-PE

2.5 mm²

Lower level earthed on terminal rail
Compact design

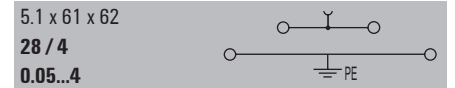
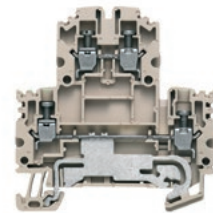

IEC 60947-7-1 (-7-2) Ex eb II C Gb II 2 G D

IEC	UL	CSA	EN 60079-7
800			550
24		20	24
2.5		AWG 26...12	4 mm ²

8 kV / 3
A3 / V-0

DEMKO15ATEX1346U

Rated connection	Further connection
0.5...4 / 1.5...4	
0.5...4 / 0.5...2.5	
0.4...0.6 / (M 2.5)	
8 / 0.6 x 3.5 mm	

0.5...1.5 / 0.5...1.5

Type	Qty.	Order No.
WDK 2.5N DU-PE	50	1041650000

Type	Qty.	Order No.
WAP WDK2.5/4 N	20	1084000000
WAP WDK2.5/4 N BL	20	1084080000
WTW EN	20	1058800000
WEW 35/2	50	1061200000
DEK 5/5 MC NE WS	1000	1609801044
WS 8/5 MC NE WS	720	1640740000
DEK 5/5 MM WS	800	2007110000
ZQV 2.5N/2	24 A 60	1527540000
ZQV 2.5N/10	24 A 20	1527690000

Screw connection with clamping yoke technology (W-Series)
Feed-through terminal blocks

WDK 4N

4 mm²

Solid/stranded
Flexible / flexible with wire-end ferrule

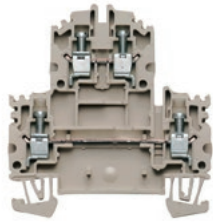

Width/Height/Depth	mm
max. current / max. cond. cross-section	A/mm ²
Max. clamping range	mm ²

6.1 x 60 x 63.25	
35 / 6	
0.13...6	

Technical data

Rated data	
Rated voltage	V
Rated current	A
for wire cross-section	mm ²
Rated impulse withstand voltage / Pollution severity	
Gauge to IEC 60947-1 / UL 94 flammability rating	
Approvals	
Clamped conductors (H05V/H07V)	
Solid / Stranded	mm ²
Flexible / Flexible with ferrule	mm ²
Tightening torque / Clamping screw	Nm
Stripping length / Blade size	mm/-
2 conductors with same cross-section (H05V/H07V)	
Solid / Stranded	-
Flexible / Flexible with ferrule	mm ²
Note	

IEC 60947-7-1

Ex eb II
C Gb II 2 G D

IEC	UL	CSA	EN 60079-7
800	600	300	550
32	35	30	30
4	AWG 26...10	AWG 26...10	6 mm ²
8 kV / 3			
A4 / V-0			

DEMKO15ATEX1346U

Rated connection	Further connection
0.5...6 / 1.5...6	
0.5...4 / 0.5...4	
0.5...1 / (M 3)	
8 / 0.6 x 3.5 mm	
0.5...1.5 / 0.5...1.5	

Ordering data

Version	
	dark beige
	Blue
Note	

Type	Qty.	Order No.
WDK 4N	50	1041900000
WDK 4N BL	50	1041980000

Accessories

Plug-in cross-connection	
	2-pole
	10-pole
End plate / Partition plate	
	dark beige
	Blue
	dark beige
End bracket	
	dark beige
Marking tags	

Type	Qty.	Order No.
ZQV 4N/2	32 A 60	1527930000
ZQV 4N/10	32 A 20	1528090000
WAP WDK2.5/4 N		
	20	1084000000
WAP WDK2.5/4 N BL		
	20	1084080000
WTW EN		
	20	1058800000
WEW 35/2		
	50	1061200000
DEK 5/6 MC NE WS		
	1000	1609820000
WS 8/6 PLUS MC NE WS		
	600	1951880000
DEK 5/6 MM WS		
	600	2007120000

For detailed information on other accessories and application in the online catalogue

WDK 4N V

4 mm²

Both levels at one potential
Compact design

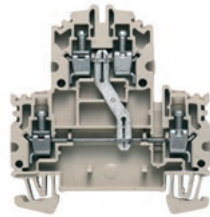

WDK 10

10 mm²

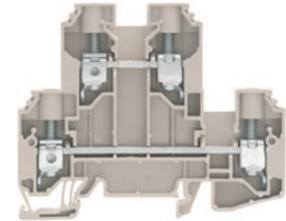

Width/Height/Depth	mm
max. current / max. cond. cross-section	A/mm ²
Max. clamping range	mm ²

6.1 x 60.7 x 63.25	
35 / 6	
0.13...6	

9.9 x 85 x 69	
70 / 16	
1.5...16	

Technical data

Rated data	
Rated voltage	V
Rated current	A
for wire cross-section	mm ²
Rated impulse withstand voltage / Pollution severity	
Gauge to IEC 60947-1 / UL 94 flammability rating	
Approvals	
Clamped conductors (H05V/H07V)	
Solid / Stranded	mm ²
Flexible / Flexible with ferrule	mm ²
Tightening torque / Clamping screw	Nm
Stripping length / Blade size	mm/-
2 conductors with same cross-section (H05V/H07V)	
Solid / Stranded	-
Flexible / Flexible with ferrule	mm ²
Note	

IEC 60947-7-1

IEC	UL	CSA	EN 60079-7
800	600	300	550
32	35	30	30
4	AWG 26...10	AWG 26...10	6 mm ²
8 kV / 3			
A4 / V-0			

Ex eb II C Gb II 2 G D

DEMKO15ATEX1346U	
Rated connection	Further connection
0.5...6 / 1.5...6	
0.5...4 / 0.5...4	
0.5...1 / (M 3)	
8 / 0.6 x 3.5 mm	
Note	

IEC 60947-7-1

IEC	UL	CSA	EN 60079-7
800	600	600	
57	64	64	
10	AWG 18...6	AWG 18...6	
8 kV / 3			
B6 / V-0			

DEMKO15ATEX1346U	
Rated connection	Further connection
1.5...16 / 1.5...16	
1.5...16 / 1.5...16	
1.2...1.9 / (M 4)	
12 / 1.0 x 5.5 mm	
Note	

Ordering data

Version	
	dark beige
	Blue
	dark beige / blue
Note	

Type	Qty.	Order No.
WDK 4N V	50	1041910000
Note		

Type	Qty.	Order No.
WDK 10	50	1186740000
WDK 10 BL	50	1186750000
Note		

Accessories

Plug-in cross-connection	
	2-pole
	10-pole
End plate / Partition plate	
	dark beige
	Blue
	dark beige
End bracket	
	dark beige
Marking tags	
Screwable cross-connection	
	2-pole
	10-pole
Cover	
	Blank, white
	Blank, yellow
Screwdriver	
	Standard

Type	Qty.	Order No.
ZQV 4N/2	32 A 60	1527930000
ZQV 4N/10	32 A 20	1528090000
WAP WDK2.5/4 N	20	1084000000
WAP WDK2.5/4 N BL	20	1084080000
WTW EN	20	1058800000
WEW 35/2	50	1061200000
DEK 5/6 MC NE WS	1000	1609820000
WS 8/6 PLUS MC NE WS	600	1951880000
DEK 5/5 MM WS	800	2007110000
Note		

Type	Qty.	Order No.
WAP WDK10	20	1186720000
WAP WDK10 BL	20	1186730000
WEW 35/2	50	1061200000
DEK 5/5 MC NE WS	1000	1609801044
WQV 10/2	76 A 50	1052560000
WQV 10/10	63 A 20	1052460000
WAD 8 MC NE WS	48	1112940000
WAD 8 MC NE GE	48	1112950000
SDS 1.0X5.5X150	1	2749380000
Note		

For detailed information on other accessories and application in the online catalogue

Screw connection with clamping yoke technology (W-Series)

Feed-through terminal blocks

WDK 10 V

10 mm²

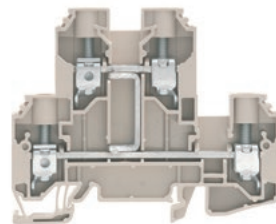

WDK 10 L

10 mm²

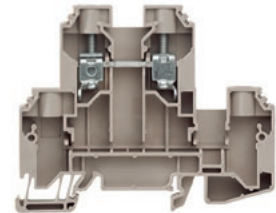

Width/Height/Depth	mm
max. current / max. cond. cross-section	A/mm ²
Max. clamping range	mm ²

9.9 x 85 x 69	
73 / 16	
1.5...16	

9.9 x 85 x 69	
70 / 16	
1.5...16	

Technical data

Rated data	
Rated voltage	V
Rated current	A
for wire cross-section	mm ²
Rated impulse withstand voltage / Pollution severity	
Gauge to IEC 60947-1 / UL 94 flammability rating	
Approvals	
Clamped conductors (H05V/H07V)	
Solid / Stranded	mm ²
Flexible / Flexible with ferrule	mm ²
Tightening torque / Clamping screw	Nm
Stripping length / Blade size	mm/-
2 conductors with same cross-section (H05V/H07V)	
Solid / Stranded	-
Flexible / Flexible with ferrule	-
Note	

IEC 60947-7-1			
IEC	UL	CSA	EN 60079-7
800	600	600	
57	49	49	
10	AWG 18...6	AWG 18...6	
8 kV / 3			
B6 / V-0			
CE CB IEC UL			
Rated connection		Further connection	
1.5...16 / 1.5...16			
1.5...16 / 1.5...16			
1.2...1.9 / (M 4)			
12 / 1.0 x 5.5 mm			
Note			

IEC 60947-7-1			
IEC	UL	CSA	EN 60079-7
800		1000	
57		70	
10	AWG 18...6	AWG 18...6	
8 kV / 3			
B6 / V-0			
CE CB IEC UL			
Rated connection		Further connection	
1.5...16 / 1.5...16			
1.5...16 / 1.5...16			
1.2...1.9 / (M 4)			
12 / 1.0 x 5.5 mm			
Note			

Ordering data

Version	
	dark beige
	Blue
	dark beige / blue
Note	

Type	Qty.	Order No.
WDK 10 V	50	1186770000
WDK 10 V BL	50	1186780000
Note		

Type	Qty.	Order No.
WDK 10 L	50	1415510000
Note		

Accessories

Plug-in cross-connection	
	2-pole
	10-pole
End plate / Partition plate	
	dark beige
	Blue
	dark beige
End bracket	
	dark beige
Marking tags	
	dark beige
Screwable cross-connection	
	2-pole
	10-pole
Cover	
	Blank, white
	Blank, yellow
Screwdriver	
	Standard

Type	Qty.	Order No.
WAP WDK10	20	1186720000
WAP WDK10 BL	20	1186730000
WEW 35/2	50	1061200000
DEK 5/5 MC NE WS	1000	1609801044
WQV 10/2	76 A 50	1052560000
WQV 10/10	63 A 20	1052460000
WAD 8 MC NE WS	48	1112940000
WAD 8 MC NE GE	48	1112950000
SDS 1.0X5.5X150	1	2749380000
Note		

Type	Qty.	Order No.
WAP WDK10	20	1186720000
WAP WDK10 BL	20	1186730000
WEW 35/2	50	1061200000
DEK 5/5 MC NE WS	1000	1609801044
WQV 10/2	76 A 50	1052560000
WQV 10/10	63 A 20	1052460000
WAD 8 MC NE WS	48	1112940000
WAD 8 MC NE GE	48	1112950000
SDS 1.0X5.5X150	1	2749380000
Note		

For detailed information on other accessories and application in the online catalogue

WDK 10 DU-N

10 mm²

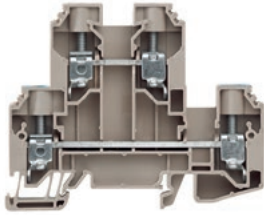

9.9 x 85 x 69
70 / 16
1.5...16

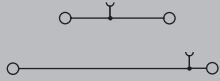

IEC 60947-7-1

IEC	UL	CSA	EN 60079-7
800	600	600	
57	64	64	
10	AWG 18...6	AWG 18...6	
8 kV / 3			
B6 / V-0			

CE ENEC 7A

Rated connection	Further connection
1.5...16 / 1.5...16	
1.5...16 / 1.5...16	
1.2...1.9 / (M 4)	
12 / 1.0 x 5.5 mm	

Type	Qty.	Order No.
WDK 10 DU-N	50	1415520000

Type	Qty.	Order No.
WAP WDK10	20	1186720000
WAP WDK10 BL	20	1186730000
WEW 35/2	50	1061200000
DEK 5/5 MC NE WS	1000	1609801044
WQV 10/2	76 A 50	1052560000
WQV 10/10	63 A 20	1052460000
WAD 8 MC NE WS	48	1112940000
WAD 8 MC NE GE	48	1112950000
SDS 1.0X5.5X150	1	2749380000



Screw connection with clamping yoke technology (W-Series)

Feed-through terminal blocks

Universal range

A

WDK 10 DU-PE

10 mm²

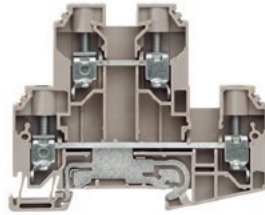

WDK 10 SET BCD

10 mm²

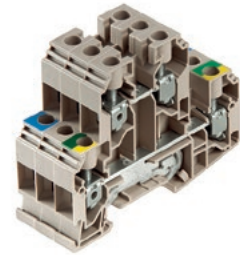

Width/Height/Depth	mm
max. current / max. cond. cross-section	A/mm ²
Max. clamping range	mm ²

9.9 x 85 x 69	
70 / 16	
1.5...16	

29.7 x 85 x 69	
70 / 16	
1.5...16	

Technical data

Rated data	
Rated voltage	V
Rated current	A
for wire cross-section	mm ²
Rated impulse withstand voltage / Pollution severity	
Gauge to IEC 60947-1 / UL 94 flammability rating	
Approvals	
Clamped conductors (H05V/H07V)	
Solid / Stranded	mm ²
Flexible / Flexible with ferrule	mm ²
Tightening torque / Clamping screw	Nm
Stripping length / Blade size	mm/-
2 conductors with same cross-section (H05V/H07V)	
Solid / Stranded	-
Flexible / Flexible with ferrule	-
Note	

IEC 60947-7-1 (-7-2)

IEC	UL	CSA	EN 60079-7
800	600	600	
57	40	40	
10	AWG 18...6	AWG 18...6	
8 kV / 3			
B6 / V-0			

CE CB IEC UL

Rated connection	Further connection
1.5...16 / 1.5...16	
1.5...16 / 1.5...16	
1.2...1.9 / (M 4)	
12 / 1.0 x 5.5 mm	

IEC 60947-7-1 (-7-2)

IEC	UL	CSA	EN 60079-7
800	600	600	
57	64	64	
10	AWG 18...6	AWG 18...6	
8 kV / 3			
B6 / V-0			

CE CB IEC UL

Rated connection	Further connection
1.5...16 / 1.5...16	
1.5...16 / 1.5...16	
1.2...1.9 / (M 4)	
12 / 1.0 x 5.5 mm	

Ordering data

Version	Type	Qty.	Order No.
dark beige with PE foot	WDK 10 DU-PE	50	1415480000
dark beige / green / yellow			
Note			

Type	Qty.	Order No.
WDK 10 DU-PE	50	1415480000

Type	Qty.	Order No.
WDK 10 SET BCD	1	1415540000

Accessories

Accessories	Type	Qty.	Order No.	
Screwable cross-connection	2-pole	76 A	50	1052560000
	10-pole	63 A	20	1052460000
End plate / Partition plate	dark beige	WAP WDK10	20	1186720000
	Blue	WAP WDK10 BL	20	1186730000
End bracket	dark beige	WEW 35/2	50	1061200000
Screwdriver	dark beige, screwable	SDS 1.0X5.5X150	1	2749380000
	Standard	SDS 1.0X5.5X150	1	2749380000
Cover	Blank, white	WAD 8 MC NE WS	48	1112940000
	Blank, yellow	WAD 8 MC NE GE	48	1112950000
Marking tags	DEK 5/5 MC NE WS	1000	1609801044	
Cross-connector	black			
	blue			
	red			

Type	Qty.	Order No.	
WQV 10/2	76 A	50	1052560000
WQV 10/10	63 A	20	1052460000
WAP WDK10	20	1186720000	
WAP WDK10 BL	20	1186730000	
WEW 35/2	50	1061200000	
SDS 1.0X5.5X150	1	2749380000	
WAD 8 MC NE WS	48	1112940000	
WAD 8 MC NE GE	48	1112950000	
DEK 5/5 MC NE WS	1000	1609801044	

Type	Qty.	Order No.	
WQV 10/2	76 A	50	1052560000
WQV 10/10	63 A	20	1052460000
WAP WDK10	20	1186720000	
WAP WDK10 BL	20	1186730000	
WEW 35/2	50	1061200000	
SDS 1.0X5.5X150	1	2749380000	
WAD 8 MC NE WS	48	1112940000	
WAD 8 MC NE GE	48	1112950000	
DEK 5/5 MC NE WS	1000	1609801044	

For detailed information on other accessories and application in the online catalogue

WDK 10 SET LS

10 mm²

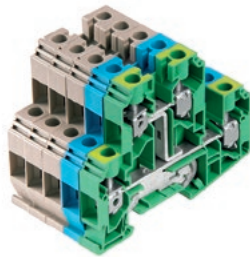

49.5 x 85 x 69
70 / 16
1.5...16

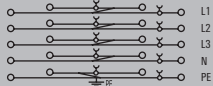

IEC 60947-7-1 (-7-2)

IEC	UL	CSA	EN 60079-7
800	600	600	
57	64	64	
10	AWG 18...6	AWG 18...6	
8 kV / 3			
B6 / V-0			

CE ENEC IEC

Rated connection	Further connection
1.5...16 / 1.5...16	
1.5...16 / 1.5...16	
1.2...1.9 / (M 4)	
12 / 1.0 x 5.5 mm	

Type	Qty.	Order No.
WDK 10 SET LS	1	1415530000

Type	Qty.	Order No.
WQV 10/2	76 A 50	1052560000
WQV 10/10	63 A 20	1052460000
WAP WDK10	20	1186720000
WAP WDK10 BL	20	1186730000
WEW 35/2	50	1061200000
SDS 1.0X5.5X150	1	2749380000
WAD 8 MC NE WS	48	1112940000
WAD 8 MC NE GE	48	1112950000
DEK 5/5 MC NE WS	1000	1609801044

MAK 2.5

2.5 mm²

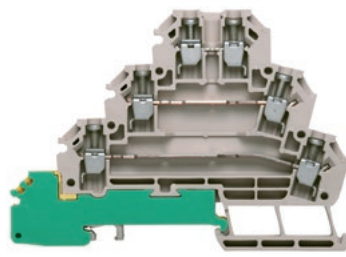

6.2 x 88 x 63
31 / 4
0.13...4

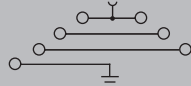

IEC 60947-7-1 (-7-2)

IEC	UL	CSA	EN 60079-7
500	300	300	
24	10	10	
2.5	AWG 26...12	AWG 26...12	
6 kV / 3			
A3 / V-0			

CE ENEC IEC

Rated connection	Further connection
0.5...4 / 0.5...4	
0.5...4 / 0.5...2.5	
0.4...0.6 / (M 2.5)	
8 / 0.6 x 3.5 mm	

0.5...1 / 0.5...1
0.5...1 / 0.5...0.75

Type	Qty.	Order No.
MAK 2.5 DB	50	7917030000

Type	Qty.	Order No.
AP MAK2.5 DB	20	7917000000
WEW 35/1	50	1059000000
SDIS 0.6X3.5X100	1	2749810000
DEK 5/5 MC NE WS	1000	1609801044
VQB 1.5/50 SW	17.5 A 5	1635120000
VQB 1.5/50 BL	17.5 A 5	1633280000
VQB 1.5/50 RT	17.5 A 5	1633290000

VLI 1.5

1.5 mm²

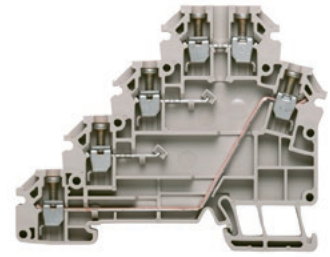

6.15 x 79.5 x 63
24 / 4
0.13...4

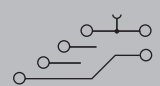

IEC 60947-7-1

IEC	UL	CSA	EN 60079-7
250	300		
17.5	10		
1.5	AWG 26...12		
4 kV / 3			
A3 / V-0			

CE ENEC IEC

Rated connection	Further connection
0.5...4 / 0.5...2.5	
0.5...4 / 0.5...2.5	
0.4...0.6 / (M 2.5)	
8 / 0.6 x 3.5 mm	

Type	Qty.	Order No.
VLI 1.5 DB	50	1784120000
VLI 1.5/PE DB	50	1784130000

Type	Qty.	Order No.
AP VLI1.5 DB	20	1784150000
WEW 35/1	50	1059000000
SDIS 0.6X3.5X100	1	2749810000
DEK 5/5 MC NE WS	1000	1609801044
VQB 1.5/50 SW	17.5 A 5	1635120000
VQB 1.5/50 BL	17.5 A 5	1633280000
VQB 1.5/50 RT	17.5 A 5	1633290000

Screw connection with clamping yoke technology (W-Series)

PE terminal blocks

Universal range

A

WPE 1.5/R3.5

1.5 mm²

Protective earth terminal for TS 15



WPE 1.5/ZZ

1.5 mm²

Twin connection



Width/Height/Depth	mm
max. current / max. cond. cross-section	-/mm ²
Max. clamping range	mm ²

3.5 x 24.5 x 24	
/ 1.5	
0.13...1.5	

5.1 x 60 x 46.5	
/ 2.5	
0.13...2.5	

Technical data

Rated data	
for wire cross-section	mm ²
Rated voltage to adjoining terminal	V
Rated impulse withstand voltage to adjacent terminal	kV
Rated short-time current	
Pollution severity	
Gauge to IEC 60947-1 / UL 94 flammability rating	
Approvals	

IEC 60947-7-2 Ex eb II C Gb II 2 G D

IEC	UL	CSA	EN 60079-7
1.5	AWG 26...18	AWG 26...18	2.5 mm ²
400			
6			
180 A (1.5 mm ²)			
3			
A1 / V-0			

IEC 60947-7-2 Ex eb II C Gb II 2 G D

IEC	UL	CSA	EN 60079-7
1.5	AWG 26...14	AWG 26...14	2.5 mm ²
800			
8			
180 A (1.5 mm ²)			
3			
A1 / V-0			

Clamped conductors (H05V/H07V)

Solid / Stranded	mm ²
Flexible / Flexible with ferrule	mm ²
Tightening torque / Clamping screw	Nm
Tightening torque for fixing screw	
Stripping length / Blade size	mm

Rated connection	
0.5...1.5 / 1.5...1.5	
0.5...1.5 / 0.5...0.5	
0.3...0.3 / (M 2)	
7 / 0.4 x 2.5 mm	

Rated connection	
0.5...2.5 / 1.5...2.5	
0.5...1.5 / 0.5...1.5	
0.4...0.6 / (M 2.5)	
0.4...0.6 Nm	
7 / 0.6 x 3.5 mm	

Note

Ordering data

Version	Green/yellow green/yellow
---------	------------------------------

Type	Qty.	Order No.
WPE 1.5/R3.5	50	1798460000

Type	Qty.	Order No.
WPE 1.5/ZZ	50	1016500000

Note

Accessories

End plate / Partition plate	dark beige
End bracket	dark beige
Screwdriver	Standard
Marking tags	

Type	Qty.	Order No.
WAP WDU1.5/R3.5	20	1754190000
EW 15	50	0382860000
DEK 5/3.5 MC NE WS	500	1755270000
DEK 5/3.5 MM WS	1000	2007100000

Type	Qty.	Order No.
WAP 2.5-10	50	1050000000
WEW 35/2	50	1061200000
SDS 0.6X3.5X100	1	2749340000
DEK 5/5 MC NE WS	1000	1609801044
WS 12/5 MC NE WS	720	1609860000
DEK 5/5 MM WS	800	2007110000
WS 8/5 MM WS	800	2007150000

For detailed information on other accessories and application in the online catalogue

WPE 2.5/1.5/ZR

2.5 mm²

Supplementary connection, right 1.5 mm² & sup 2;



5.1 x 60 x 46.5
/ 4
0.05...4

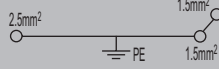

IEC 60947-7-2 Ex eb II C Gb **Ex** II 2 G D

IEC	UL	CSA	EN 60079-7
2.5	AWG 26...12	AWG 26...12	2.5 mm ²
800			
8			
300 A (2.5 mm ²)			
3			
A3 / V-0			



Rated connection

0.5...4 / 1.5...4
0.5...4 / 0.5...2.5
0.4...0.6 / (M 2.5)
0.4...0.6 Nm
10 / 0.6 x 3.5 mm

Type	Qty.	Order No.
WPE 2.5/1.5/ZR	50	1016400000

Type	Qty.	Order No.
WAP 2.5-10	50	1050000000
WEW 35/2	50	1061200000
SDS 0.6X3.5X100	1	2749340000
DEK 5/5 MC NE WS	1000	1609801044
WS 12/5 MC NE WS	720	1609860000
DEK 5/5 MM WS	800	2007110000
WS 8/5 MM WS	800	2007150000

AKE 2.5

2.5 mm²

Protective earth terminal for TS 15



5.1 x 28 x 26
/ 4
0.13...4

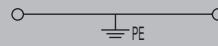

IEC 60947-7-2 Ex eb II C Gb **Ex** II 2 G D

IEC	UL	CSA	EN 60079-7
2.5	AWG 26...12	AWG 26...12	4 mm ²
250			
4			
300 A (2.5 mm ²)			
3			
A3 / V-2			



Rated connection

0.5...4 / 1.5...2.5
0.5...2.5 / 0.5...2.5
0.4...0.6 / (M 2.5)
7 / 3.0 x 0.5 mm

Type	Qty.	Order No.
AKE 2.5	100	1303360000

Type	Qty.	Order No.
WAP 2.5-10	50	1050000000
EW 15	50	0382860000
SDS 0.6X3.5X100	1	2749340000
DEK 5/5 MC NE WS	1000	1609801044

WPE 2.5

2.5 mm²

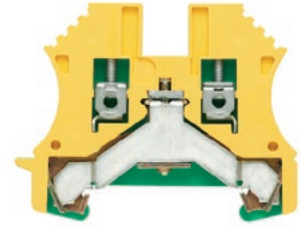

5.1 x 60 x 46.5
/ 4
0.05...4

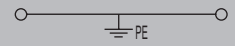

IEC 60947-7-2 Ex eb II C Gb **Ex** II 2 G D

IEC	UL	CSA	EN 60079-7
2.5	AWG 26...12	AWG 26...12	2.5 mm ²
800			
8			
300 A (2.5 mm ²)			
3			
A3 / V-0			



Rated connection

0.5...4 / 0.5...4
0.5...4 / 0.5...2.5
0.4...0.6 / (M 2.5)
0.4...0.8 Nm
10 / 0.6 x 3.5 mm

Type	Qty.	Order No.
WPE 2.5	100	1010000000

Type	Qty.	Order No.
WAP 2.5-10	50	1050000000
WEW 35/2	50	1061200000
SDS 0.6X3.5X100	1	2749340000
DEK 5/5 MC NE WS	1000	1609801044
WS 12/5 MC NE WS	720	1609860000



Screw connection with clamping yoke technology (W-Series)

PE terminal blocks

Universal range

A

WPE 2.5N

2.5 mm²

Compact design



AKE 4

4 mm²

Protective earth terminal for TS 15

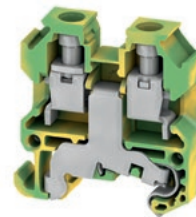

Width/Height/Depth	mm
max. current / max. cond. cross-section	-/mm ²
Max. clamping range	mm ²

5.1 x 54 x 37	
/ 4	
0.05...4	

6.1 x 27 x 29	
/ 4	
0.13...4	

Technical data

Rated data	
for wire cross-section	mm ²
Rated voltage to adjoining terminal	V
Rated impulse withstand voltage to adjacent terminal	kV
Rated short-time current	
Pollution severity	
Gauge to IEC 60947-1 / UL 94 flammability rating	
Approvals	

IEC 60947-7-2 Ex eb II C Gb II 2 G D

IEC	UL	CSA	EN 60079-7
2.5	AWG 26...12	AWG 26...12	2.5 mm ²
500			
6			
300 A (2.5 mm ²)			
3			
A3 / V-0			

IEC 60947-7-2 Ex eb II C Gb II 2 G D

IEC	UL	CSA	EN 60079-7
4	AWG 26...12	AWG 26...12	4 mm ²
500			
6			
480 A (4 mm ²)			
3			
A3 / V-0			

Clamped conductors (H05V/H07V)

Solid / Stranded	mm ²
Flexible / Flexible with ferrule	mm ²
Tightening torque / Clamping screw	Nm
Tightening torque for fixing screw	
Stripping length / Blade size	mm

Rated connection	
0.5...4 / 1.5...4	
0.5...4 / 0.5...2.5	
0.4...0.6 / (M 2.5)	
0.4...0.6 Nm	
10 / 0.6 x 3.5 mm	

Rated connection	
0.5...4 / 1.5...4	
0.5...4 / 0.5...2.5	
0.5...1 / (M 3)	
9 / 0.6 x 3.5 mm	

Note

Ordering data

Version	Green/yellow green/yellow
---------	------------------------------

Note

Type	Qty.	Order No.
WPE 2.5N	50	1016200000

Type	Qty.	Order No.
AKE 4	100	0380260000

Accessories

End plate / Partition plate	dark beige
End bracket	dark beige
Screwdriver	Standard
Marking tags	

Type	Qty.	Order No.
WAP WDU2.5N/4N	50	1060000000
WEW 35/2	50	1061200000
SDS 0.6X3.5X100	1	2749340000
DEK 5/5 MC NE WS	1000	1609801044
WS 12/5 MC NE WS	720	1609860000
DEK 5/5 MM WS	800	2007110000
WS 8/5 MM WS	800	2007150000

Type	Qty.	Order No.
AP AKZ4	20	0294460000
EW 15	50	0382860000
SDS 0.6X3.5X100	1	2749340000
DEK 5/6 MC NE WS	1000	1609820000
DEK 5/6 MM WS	600	2007120000

For detailed information on other accessories and application in the online catalogue

WPE 4

4 mm²



6.1 x 56 x 46.5
/ 6
0.13...6

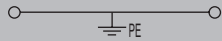

IEC 60947-7-2 Ex eb II C Gb II 2 G D

IEC	UL	CSA	EN 60079-7
4	AWG 26...10	AWG 26...10	4 mm ²
800			
8			
480 A (4 mm ²)			
3			
A4 / V-0			



Rated connection

0.5...6 / 0.5...6
0.5...6 / 0.5...4
0.5...1 / (M 3)
0.4...0.8 Nm
10 / 0.6 x 3.5 mm

WPE 4/ZZ

4 mm²

Twin connection

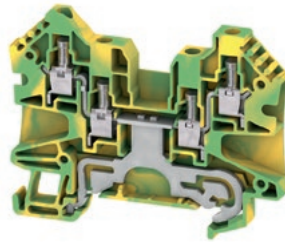

6.1 x 70 x 53
/ 6
0.05...6

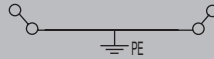

IEC 60947-7-2 Ex eb II C Gb II 2 G D

IEC	UL	CSA	EN 60079-7
4	AWG 30...10	AWG 30...10	4 mm ²
800			
8			
480 A (4 mm ²)			
3			
A4 / V-0			



Rated connection

0.5...6 / 0.5...4
0.5...4 / 0.5...4
0.5...0.8 / (M 3)
10 / 0.6 x 3.5 mm

WPE 4/ZR

4 mm²

Additional connection, right side

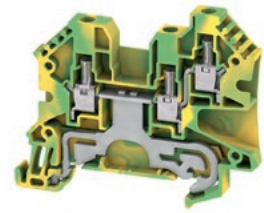

6.1 x 63.5 x 52.8
/ 6
0.05...6

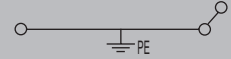

IEC 60947-7-2 Ex eb II C Gb II 2 G D

IEC	UL	CSA	EN 60079-7
4	AWG 30...10	AWG 30...10	4 mm ²
800			
8			
480 A (4 mm ²)			
3			
A4 / V-0			



Rated connection

0.5...6 / 0.5...4
0.5...4 / 0.5...4
0.5...0.8 / (M 3)
10 / 0.6 x 3.5 mm

Type	Qty.	Order No.
WPE 4	100	1010100000

Type	Qty.	Order No.
WPE 4/ZZ	50	1905130000

Type	Qty.	Order No.
WPE 4/ZR	50	1905120000

Type	Qty.	Order No.
WEW 35/2	50	1061200000
SDS 0.6X3.5X100	1	2749340000
DEK 5/6 MC NE WS	1000	1609820000
DEK 5/6 MM WS	600	2007120000
WS 8/6 MM WS	600	2007160000

Type	Qty.	Order No.
WAP WDU/WTR4/ZZ	50	1905150000
WEW 35/2	50	1061200000
SDS 0.6X3.5X100	1	2749340000
DEK 5/6 MC NE WS	1000	1609820000
DEK 5/6 MM WS	600	2007120000
WS 8/6 MM WS	600	2007160000

Type	Qty.	Order No.
WAP WDU/WTR4/ZR	50	1905070000
WEW 35/2	50	1061200000
SDS 0.6X3.5X100	1	2749340000
DEK 5/6 MC NE WS	1000	1609820000
DEK 5/6 MM WS	600	2007120000
WS 8/6 MM WS	600	2007160000



WPE 10

10 mm²



9.9 x 56 x 46.5
/ 16
1.31...16

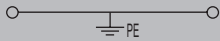

IEC 60947-7-2 Ex eb II C Gb II 2 G D

IEC	UL	CSA	EN 60079-7
10	AWG 16...6	AWG 16...6	10 mm ²
800			
8			
1200 A (10 mm ²)			
3			
B6 / V-0			

Rated connection

1.5...16 / 1.5...16
1.5...16 / 1.5...16
1.2...2.4 / (M 4)
0.5...1.0 Nm
12 / 1.0 x 5.5 mm

Type	Qty.	Order No.
WPE 10	50	1010300000

Type	Qty.	Order No.
WEW 35/2	50	1061200000
SDS 1.0x5.5x150	1	2749380000
DEK 5/5 MC NE WS	1000	1609801044
WS 12/6.5 MC NE WS	540	1609920000
WQB-PEN 10	57 A 10	1060300000

WPE 10/ZR

10 mm²

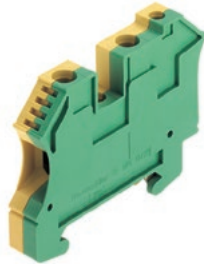

9.9 x 66 x 49
/ 16
1.31...16

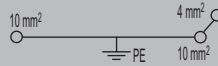

IEC 60947-7-2

IEC	UL	CSA	EN 60079-7
10	AWG 16...6	AWG 14...6	
1000			
8			
1200 A (10 mm ²)			
3			
B6, A4 / V-0			

Rated connection

1.5...16 / 1.5...16
1.5...16 / 1.5...16
1.2...1.9 / (M 4)
0.5...1.0 Nm
12 / 0.6 x 3.5 mm

Type	Qty.	Order No.
WPE 10/ZR	50	1042500000

Type	Qty.	Order No.
WEW 35/2	50	1061200000
SDS 0.6x3.5x100	1	2749340000
DEK 5/5 MC NE WS	1000	1609801044
WS 12/6.5 MC NE WS	540	1609920000
WQB-PEN 10	57 A 10	1060300000

WPE 16

16 mm²



11.9 x 56 x 62.5
/ 25
1.5...25

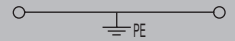

IEC 60947-7-2 Ex eb II C Gb II 2 G D

IEC	UL	CSA	EN 60079-7
16	AWG 14...4	AWG 14...6	16 mm ²
1000			
8			
1920 A (16 mm ²)			
3			
B7 / V-0			

Rated connection

1.5...16 / 1.5...25
1.5...25 / 1.5...16
2...3.6 / (M 5)
1.2...2.4 Nm
16 / 1.0 x 5.5 mm

Type	Qty.	Order No.
WPE 16	50	1010400000

Type	Qty.	Order No.
WEW 35/1	50	1059000000
SDS 1.0x5.5x150	1	2749380000
DEK 5/5 MC NE WS	1000	1609801044
WS 12/6.5 MC NE WS	540	1609920000
WQB-PEN 16	76 A 10	1060200000



Screw connection with clamping yoke technology (W-Series)

PE terminal blocks

Universal range

A

WPE 16N

16 mm²

Compact design



WPE 35

35 mm²

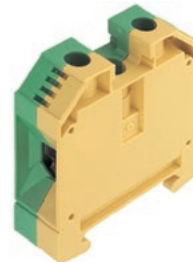

Width/Height/Depth	mm
max. current / max. cond. cross-section	-/mm ²
Max. clamping range	mm ²

12 x 56 x 46.5	
/ 25	
1.5...25	

16 x 56 x 62.5	
/ 35	
2.5...35	

Technical data

Rated data	
for wire cross-section	mm ²
Rated voltage to adjoining terminal	V
Rated impulse withstand voltage to adjacent terminal	kV
Rated short-time current	
Pollution severity	
Gauge to IEC 60947-1 / UL 94 flammability rating	
Approvals	

IEC 60947-7-2			
IEC	UL	CSA	EN 60079-7
16	AWG 14...6	AWG 14...6	
400			
6			
1920 A (16 mm ²)			
3			
B7 / V-0			

IEC 60947-7-2				Ex eb II	C Gb	II 2 G D
IEC	UL	CSA	EN 60079-7			
35	AWG 12...2	AWG 12...2	35 mm ²			
800						
8						
4200 A (35 mm ²)						
3						
B8 / V-0						

Clamped conductors (H05V/H07V)

Solid / Stranded	mm ²
Flexible / Flexible with ferrule	mm ²
Tightening torque / Clamping screw	Nm
Tightening torque for fixing screw	
Stripping length / Blade size	mm

Rated connection			
1.5...16 / 1.5...25			
1.5...16 / 4...16			
1.2...2.4 / (M 4)			
0.5...1.0 Nm			
12 / 1.0 x 5.5 mm			

Rated connection			
2.5...50 / 2.5...50			
2.5...35 / 2.5...35			
4...5 / (M 6)			
1.2...2.4 Nm			
18 / 6.5 x 1.2 mm			

Note

Ordering data

Version	
	Green/yellow
	green/yellow

Note

Type	Qty.	Order No.
WPE 16N	50	1019100000

Type	Qty.	Order No.
WPE 35	25	1010500000

Accessories

PEN bridge	
End bracket	dark beige dark beige, screwable
Screwdriver	Standard
Marking tags	

Type	Qty.	Order No.
WQV 16N-PEN BL	76 A 10	1071360000
WEW 35/2	50	1061200000
SDS 1.0X5.5X150	1	2749380000
DEK 5/5 MC NE WS	1000	1609801044
WS 12/6.5 MC NE WS	540	1609920000

Type	Qty.	Order No.
WQB-PEN 35	135 A 10	1060100000
WEW 35/1	50	1059000000
SDS 1.2X6.5X150	1	2749390000
DEK 5/5 MC NE WS	1000	1609801044
WS 12/6.5 MC NE WS	540	1609920000

For detailed information on other accessories and application in the online catalogue

WPE 35/IKSC

35 mm²

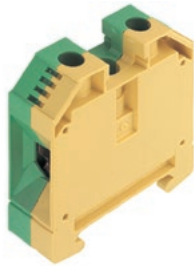

16 x 56 x 62.5
/ 35
2.5...35

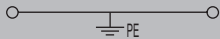

IEC 60947-7-2 Ex eb II C Gb II 2 G D

IEC	UL	CSA	EN 60079-7
35	AWG 12...1	AWG 12...2	35 mm ²
800			
8			
4200 A (35 mm ²)			
3			
B8 / V-0			

Rated connection

2.5...16 / 2.5...35
2.5...35 / 2.5...35
5 / (M 6)
1.2...2.4 Nm
18 / S4 (DIN 6911)

WPE 35N

35 mm²



16 x 66 x 50.5
/ 50
2.5...50

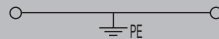

IEC 60947-7-2 Ex eb II C Gb II 2 G D

IEC	UL	CSA	EN 60079-7
35	AWG 12...2		35 mm ²
400			
6			
4200 A (35 mm ²)			
3			
B8 / V-0			

Rated connection

2.5...16 / 2.5...50
2.5...35 / 2.5...35
4...5 / (M 6)
1.2...2.4 Nm
18 / 6.5 x 1.2 mm

WPE 50N

50 mm²



18.5 x 71 x 69.6
/ 70
5.26...70

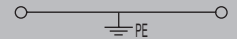

IEC 60947-7-2 Ex eb II C Gb II 2 G D

IEC	UL	CSA	EN 60079-7
50	AWG 10...0	AWG 14...0	50 mm ²
1000			
8			
6000 A (50 mm ²)			
3			
B10 / V-0			

Rated connection

10...16 / 10...70
10...50
4...6 / (M 6)
3.0...4.0 Nm
24 / S4 (DIN 6911)

Type	Qty.	Order No.
WPE 35/IKSC	25	1012600000

Type	Qty.	Order No.
WPE 35N	20	1717740000

Type	Qty.	Order No.
WPE 50N	10	1846040000

Type	Qty.	Order No.
WQB-PEN 35	135 A 10	1060100000
WEW 35/1	50	1059000000
SDS 1.2X6.5X150	1	2749390000
DEK 5/5 MC NE WS	1000	1609801044
WS 12/6.5 MC NE WS	540	1609920000

Type	Qty.	Order No.
WEW 35/2	50	1061200000
SDS 1.2X6.5X150	1	2749390000
DEK 5/5 MC NE WS	1000	1609801044
WS 12/6.5 MC NE WS	540	1609920000

Type	Qty.	Order No.
WQV PEN 50N	150 A 5	9201610000
WEW 35/1	50	1059000000
SKS 2,0-8,0 MR	1	9008870000
DEK 5/8 MC NE WS	800	1856740000
WS 12/6.5 MC NE WS	540	1609920000



Screw connection with clamping yoke technology (W-Series)

PE terminal blocks

Universal range

A

WPE 70N/35

70 mm²

Compact design



WPE 95N/120N

95 mm²

Compact design



Width/Height/Depth	mm
max. current / max. cond. cross-section	-/mm ²
Max. clamping range	mm ²

20.5 x 75 x 85	
/ 95	
16...95	

27 x 91 x 90	
/ 150	
16...150	

Technical data

Rated data	
for wire cross-section	mm ²
Rated voltage to adjoining terminal	V
Rated impulse withstand voltage to adjacent terminal	kV
Rated short-time current	
Pollution severity	
Gauge to IEC 60947-1 / UL 94 flammability rating	
Approvals	

IEC 60947-7-2

Ex eb II C Gb II 2 G D			
IEC	UL	CSA	EN 60079-7
70	AWG 6...0	AWG 6...0	70 mm ²
1000			
8			
8400 A (70 mm ²)			
3			
B11 / V-0			

IEC 60947-7-2

Ex eb II C Gb II 2 G D			
IEC	UL	CSA	EN 60079-7
95	AWG 4...0	AWG 4...0	120 mm ²
1000			
8			
11400 A (95 mm ²)			
3			
B13 / V-0			

Clamped conductors (H05V/H07V)	
Solid / Stranded	mm ²
Flexible / Flexible with ferrule	mm ²
Tightening torque / Clamping screw	Nm
Tightening torque for fixing screw	
Stripping length / Blade size	mm

Rated connection	
16...16 / 16...95	
16...70 / 16...50	
8...12 / (M 8)	
2.0...4.0 Nm	
22 / S6 (DIN 6911)	

Rated connection	
16...16 / 16...150	
16...120	
16...20 / (M 10)	
3.0...4.0 Nm	
27 / S6 (DIN 6911)	

Note

Ordering data

Version	Green/yellow green/yellow
---------	------------------------------

Type	Qty.	Order No.
WPE 70N/35	10	9512200000

Type	Qty.	Order No.
WPE 95N/120N	5	1846030000

Note

Accessories

PEN bridge	
End bracket	
	dark beige dark beige, screwable
Screwdriver	
	Standard
Marking tags	

Type	Qty.	Order No.
WQV 70N-PEN	192 A	5 9525840000
WEW 35/1	50	1059000000
SKS 2,0-8,0 MR	1	9008870000
DEK 5/5 MC NE WS	1000	1609801044
WS 12/6.5 MC NE WS	540	1609920000

Type	Qty.	Order No.
WQV PEN 95N/120N	269 A	5 9201630000
WEW 35/1	50	1059000000
SKS 2,0-8,0 MR	1	9008870000
DEK 5/5 MC NE WS	1000	1609801044
WS 12/6.5 MC NE WS	540	1609920000

For detailed information on other accessories and application in the online catalogue

WPE 70/95

95 mm²

Conductor can be inserted from above / leaf spring

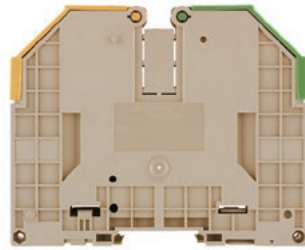

Width/Height/Depth	mm
max. current / max. cond. cross-section	-/mm ²
Max. clamping range	mm ²

27 x 132 x 107	
/ 120	
13.3...120	

Technical data

Rated data	
for wire cross-section	mm ²
Rated voltage to adjoining terminal	V
Rated impulse withstand voltage to adjacent terminal	kV
Rated short-time current	
Pollution severity	
Gauge to IEC 60947-1 / UL 94 flammability rating	
Approvals	

Clamped conductors (H05V/H07V)

Solid / Stranded	mm ²
Flexible / Flexible with ferrule	mm ²
Tightening torque / Clamping screw	Nm
Tightening torque for fixing screw	
Stripping length / Blade size	mm

Note

Ordering data

Version	green/yellow
Note	

Accessories

PEN bridge	
End bracket	dark beige, screwable
Marking tags	
Screwdriver	Standard

IEC 60947-2

IEC	UL	CSA	EN 60079-7
95	AWG 6...0	AWG 6...0	95 mm ²
1000			
8			
11400 A (95 mm ²)			
3			
B12 / V-0			

Ex eb II C Gb II 2 G D

Rated connection

16...16 / 16...120
16...95 / 35...50
6...12 / (M 8)
3.0...6.0 Nm
30 / S6 (DIN 6911)

WPE 120/150

120 mm²

Conductor can be inserted from above / leaf spring

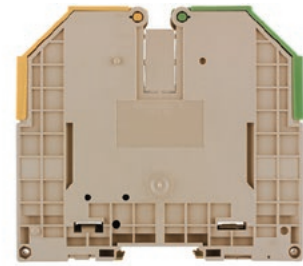

32 x 132 x 117	
/ 150	
33.62...150	

IEC 60947-2 Ex eb II C Gb II 2 G D

IEC	UL	CSA	EN 60079-7
120	AWG 2...250	AWG 2...250	150 mm ²
1000			
8			
14400 A (120 mm ²)			
3			
B13 / V-0			

Rated connection

/ 35...150
35...150 / 35...50
10...20 / (M 10)
3.0...6.0 Nm
35 / S6 (DIN 6911)

Type	Qty.	Order No.
WPE 120/150	10	1019700000

Type	Qty.	Order No.
WQV 120-PEN	292 A 5	1072400000
WEW 35/1	50	1059000000
DEK 5/5 MC NE WS	1000	1609801044
WS 12/6.5 MC NE WS	540	1609920000
SKS 2,0-8,0 MR	1	9008870000

For detailed information on other accessories and application in the online catalogue



Screw connection with clamping yoke technology (W-Series)

PE terminal blocks

Universal range

A

WDK 2.5 PE

2.5 mm²



WDK 2.5N PE

2.5 mm²

Compact design

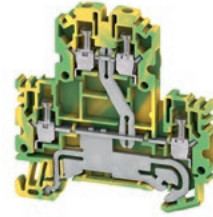

Width/Height/Depth	mm
max. current / max. cond. cross-section	-/mm ²
Max. clamping range	mm ²

5.1 x 69.5 x 62.5	
/ 4	
0.05...4	

5.1 x 60.7 x 54.95	
/ 4	
0.05...4	

Technical data

Rated data	
for wire cross-section	mm ²
Rated voltage to adjoining terminal	V
Rated impulse withstand voltage to adjacent terminal	kV
Rated short-time current	
Pollution severity	
Gauge to IEC 60947-1 / UL 94 flammability rating	
Approvals	

IEC 60947-7-2	Ex eb II	C Gb		II 2 G D
IEC	UL	CSA	EN 60079-7	
2.5	AWG 22...12	AWG 26...12	4 mm ²	
400				
6				
	300 A (2.5 mm ²)			
	3			
	A3 / V-0			

IEC 60947-7-2	Ex eb II	C Gb		II 2 G D
IEC	UL	CSA	EN 60079-7	
2.5		AWG 26...12	4 mm ²	
800				
8				
	300 A (2.5 mm ²)			
	3			
	A3 / V-0			

Clamped conductors (H05V/H07V)

Solid / Stranded	mm ²
Flexible / Flexible with ferrule	mm ²
Tightening torque / Clamping screw	Nm
Stripping length / Blade size	mm

Rated connection	
0.5...4 / 1.5...4	
0.5...4 / 0.5...2.5	
0.4...0.6 / (M 2.5)	
10 / 0.6 x 3.5 mm	

Rated connection	
0.5...4 / 1.5...4	
0.5...4 / 0.5...2.5	
0.4...0.6 / (M 2.5)	
8 / 0.6 x 3.5 mm	

Note

Ordering data

Version	green/yellow
Note	

Type	Qty.	Order No.
WDK 2.5PE	50	1036300000

Type	Qty.	Order No.
WDK 2.5N PE	50	1041620000

Accessories

Screwable cross-connection	
	2-pole
	10-pole
End plate / Partition plate	
	dark beige
	Blue
	dark beige
End bracket	
	dark beige
Screwdriver	
	Standard
Marking tags	
Cover	
	Blank, white
	Blank, yellow

Type	Qty.	Order No.
WQV 2.5/2	32 A 50	1053660000
WQV 2.5/10	32 A 20	1054460000
WAP WDK2.5	20	1059100000
WEW 35/2	50	1061200000
SDS 0.6X3.5X100	1	2749340000
DEK 5/5 MC NE WS	1000	1609801044
WS 8/5 MC NE WS	720	1640740000
DEK 5/5 MM WS	800	2007110000

Type	Qty.	Order No.
WAP WDK2.5/4 N	20	1084000000
WAP WDK2.5/4 N BL	20	1084080000
WTW EN	20	1058800000
WEW 35/2	50	1061200000
SDS 0.6X3.5X100	1	2749340000
DEK 5/5 MC NE WS	1000	1609801044
WS 8/5 MC NE WS	720	1640740000
DEK 5/5 MM WS	800	2007110000

For detailed information on other accessories and application in the online catalogue

WDK 4N PE

4 mm²

Compact design

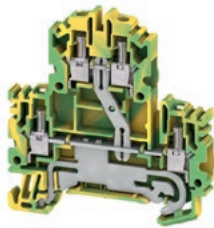

6.1 x 60.7 x 63.25
/ 6
0.13...6



Ex eb II
C Gb II 2 G D

IEC 60947-7-2

IEC	UL	CSA	EN 60079-7
4	AWG 26...10	AWG 26...10	6 mm ²
800			
8			
	480 A (4 mm ²)		
	3		
	A3 / V-0		

Rated connection

0.5...6 / 1.5...6
0.5...4 / 1.5...4
0.5...1 / (M 3)
8 / 0.6 x 3.5 mm

WDK 10 PE

10 mm²

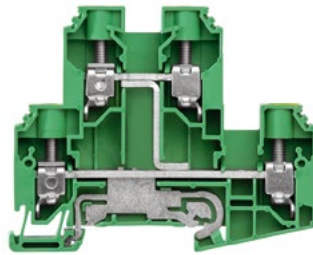

9.9 x 85 x 69
70 / 16
1.5...16



IEC 60947-7-2

IEC	UL	CSA	EN 60079-7
10	AWG 18...6	AWG 18...6	
800			
8			
	1200 A (10 mm ²)		
	3		
	B6 / V-0		

Rated connection

1.5...16 / 1.5...16
1.5...16 / 1.5...16
1.2...1.9 / (M 4)
12 / 1.0 x 5.5 mm

Type	Qty.	Order No.
WDK 4N PE	50	1041920000

Type	Qty.	Order No.
WDK 10 PE	50	1415470000

Type	Qty.	Order No.
WAP WDK2.5/4 N	20	1084000000
WEW 35/2	50	1061200000
SDS 0.6X3.5X100	1	2749340000
DEK 5/6 MC NE WS	1000	1609820000
WS 8/5 MM WS	800	2007150000
DEK 5/5 MM WS	800	2007110000

Type	Qty.	Order No.	
WQV 10/2	76 A	50	1052560000
WQV 10/10	63 A	20	1052460000
WAP WDK10	20	1186720000	
WAP WDK10 BL	20	1186730000	
WEW 35/2	50	1061200000	
SDS 1.0X5.5X150	1	2749380000	
DEK 5/5 MC NE WS	1000	1609801044	
WAD 8 MC NE WS	48	1112940000	
WAD 8 MC NE GE	48	1112950000	



Screw connection with clamping yoke technology (W-Series)

Fuse terminal blocks

WFS 4

4 mm²

WFS 4

Overload and short-circuit protection



Width/Height/Depth	mm
max. current / max. cond. cross-section	A/mm ²
Max. clamping range	mm ²

6.1 x 62.5 x 75
6.3 / 6
0.22...6

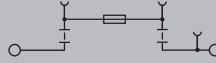

Technical data

Rated data	
Rated voltage to adjoining terminal	V
Rated current	A
for wire cross-section	mm ²
Rated impulse withstand voltage / Pollution severity	
UL 94 flammability rating	
Approvals	
Clamped conductors (H05V/H07V)	
Solid / Stranded	mm ²
Flexible / Flexible with ferrule	mm ²
Tightening torque / Clamping screw	Nm
Blade size	

IEC 60947-7-3

IEC	UL	CSA	EN 60079-7
400	300 (D)	300 (D)	
6.3	10	10	6.3
4	AWG 22...10	AWG 22...10	6 mm ²
6 kV / 3			
V-0			

CE TÜV20ATEX8502U

Rated connection	
0.5...6 / 1.5...6	
0.5...4 / 0.5...4	
0.5...0.6 / (M 3)	
0.6 x 3.5 mm	

Note

Ordering data

Version	
black, 500 V AC/DC, without LED	
blue, 500 V AC/DC, without LED	
dark beige, 500 V AC/DC, without LED	

Note

Accessories

End bracket	dark beige
Screwdriver	With "swifty set" cutting device Standard
G-fuse cartridge, 5 x 20 mm (IEC 60127-2)	0.25 A fast 0.50 A fast 1.00 A fast 2.00 A fast
Marking tags	

Type	Qty.	Order No.
WFS 4	50	2561900000
WFS 4 BL	50	2562000000
WFS 4 DB	50	2562050000

Type	Qty.	Order No.
WEW 35/2	50	1061200000
SWIFTY SET	1	9006060000
SDS 0.6X3.5X100	1	2749340000
G 20/0.25A/F	0.25 A 10	0430500000
G 20/0.50A/F	0.5 A 10	0430600000
G 20/1.00A/F	1 A 10	0430700000
G 20/2.00A/F	2 A 10	0430900000
DEK 5/6 MC NE WS	1000	1609820000
WS 12/6 MC NE WS	600	1609900000

For detailed information on other accessories and application in the online catalogue

Type	Order No.
WFS 4 10-36V	2562070000

Arrangement	Applications			
	Only short-circuit protection		Overload and short-circuit protection	
	T _A max.	Nominal values	T _A max.	Nominal values
Individual	55 °C	4.0 W / 10 A	35 °C	2.5 W / 2.5 A
In combination	68 °C	2.5 W / 2.5 A	41 °C	1.6 W / 1.0 A

WFS 4 LED

4 mm²

WFS 4 LED

Overload and short-circuit protection

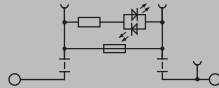

Width/Height/Depth	mm
max. current / max. cond. cross-section	A/mm ²
Max. clamping range	mm ²

6.1 x 62.5 x 75
6.3 / 6
0.22...6

Technical data

Rated data	
Rated voltage to adjoining terminal	V
Rated current	A
for wire cross-section	mm ²
Rated impulse withstand voltage / Pollution severity	
UL 94 flammability rating	
Approvals	
Clamped conductors (H05V/H07V)	
Solid / Stranded	mm ²
Flexible / Flexible with ferrule	mm ²
Tightening torque / Clamping screw	Nm
Blade size	

IEC 60947-7-3

IEC	UL	CSA	EN 60079-7
400	300 (D)	300 (D)	
6.3	10	10	
4	AWG 22...10	AWG 22...10	6 mm ²
6 kV / 3			
V-0			

CE TÜV20ATEX8502U

Rated connection	
0.5...6 / 1.5...6	
0.5...4 / 0.5...4	
0.5...0.6 / (M 3)	
0.6 x 3.5 mm	

Note

Ordering data

Version	
	10-36 V AC/DC, with LED
	30-70 V AC/DC, with LED
	60-150 V AC/DC, with LED
	100 - 250 V AC/DC, with LED

Note

Type	Qty.	Order No.
WFS 4 10-36V	50	2562070000
WFS 4 30-70V	50	2561990000
WFS 4 60-150V	50	2561970000
WFS 4 100-250V	50	2561960000

Accessories

End plate / Partition plate	dark beige
End bracket	dark beige
Screwdriver	With "swifty set" cutting device Standard
G-fuse cartridge, 5 x 20 mm (IEC 60127-2)	0.25 A fast 0.50 A fast 1.00 A fast
Marking tags	

Type	Qty.	Order No.
WAP 2.5-10	50	1050000000
WEW 35/2	50	1061200000
SWIFTY SET	1	9006060000
SDS 0.6X3.5X100	1	2749340000
G 20/0.25A/F	0.25 A 10	0430500000
G 20/0.50A/F	0.5 A 10	0430600000
G 20/1.00A/F	1 A 10	0430700000
DEK 5/6 MC NE WS	1000	1609820000
WS 12/6 MC NE WS	600	1609900000

For detailed information on other accessories and application in the online catalogue



Screw connection with clamping yoke technology (W-Series)

Fuse terminal blocks

WSI 4

4 mm²

WSI 4

Overload and short-circuit protection



Width/Height/Depth	mm
max. current / max. cond. cross-section	A/mm ²
Max. clamping range	mm ²

8 x 50.7 x 42.5
6.3 / 4
0.5...4



Technical data

Rated data	
Rated voltage to adjoining terminal	V
Rated current	A
for wire cross-section	mm ²
Rated impulse withstand voltage / Pollution severity	
UL 94 flammability rating	
Approvals	
Clamped conductors (H05V/H07V)	
Solid / Stranded	mm ²
Flexible / Flexible with ferrule	mm ²
Tightening torque / Clamping screw	Nm
Blade size	

IEC 60947-7-3

IEC	UL	CSA	EN 60079-7
500	300 (C)	300 (C)	
6.3	15	15	
4	AWG 30...12	AWG 30...12	
6 kV / 3			
V-0			

CE, RoHS, REACH, WEEE, EN 60947-7-3

Rated connection	
0.5...4 / 1.5...4	
0.5...4	
0.4...0.4 / (M 3)	
0.6 x 3.5 mm	

Note

Ordering data

Version	
500 V AC/DC, without LED	
10-36 V AC/DC, with LED	
30-70 V AC/DC, with LED	
60-150 V AC/DC, with LED	
140-250 V AC/DC, with LED	

Note

Accessories

End bracket	dark beige
Screwdriver	With "swifty set" cutting device Standard
G-fuse cartridge, 5 x 20 mm (IEC 60127-2)	0.25 A fast 0.50 A fast 1.00 A fast 2.00 A fast
Marking tags	

Type	Qty.	Order No.
WSI 4	50	1886580000
WSI 4/LD 10-36V AC/DC	50	1886590000
WSI 4/LD 30-70V AC/DC	50	1886560000
WSI 4/LD 60-150V AC/DC	50	1886570000
WSI 4/LD 140-250V AC/DC	50	1886550000

Type	Qty.	Order No.
WEW 35/2	50	1061200000
SWIFTY SET	1	9006060000
SDS 0.6X3.5X100	1	2749340000
G 20/0.25A/F	0.25 A 10	0430500000
G 20/0.50A/F	0.5 A 10	0430600000
G 20/1.00A/F	1 A 10	0430700000
G 20/2.00A/F	2 A 10	0430900000
DEK 5/5 MC NE WS	1000	1609801044
WS 12/6 MC NE WS	600	1609900000

For detailed information on other accessories and application in the online catalogue

Type	Order No.
WSI 4	1886580000

Arrangement	Applications			
	Only short-circuit protection		Overload and short-circuit protection	
	T _A max.	Nominal values	T _A max.	Nominal values
Individual	63 °C	4.0 W / 6.3 A	34 °C	1.6 W / 6.3 A
In combination	47 °C	2.5 W / 6.3 A	23 °C	1.6 W / 6.3 A

WSI 4 Ex

4 mm²



Width/Height/Depth	mm
max. current / max. cond. cross-section	A/mm ²
Max. clamping range	mm ²

8 x 50.7 x 42.5
6.3 / 4
0.5...4



Technical data

Rated data	
Rated voltage to adjoining terminal	V
Rated current	A
for wire cross-section	mm ²
Rated impulse withstand voltage / Pollution severity	
UL 94 flammability rating	
Approvals	
Clamped conductors (H05V/H07V)	
Solid / Stranded	mm ²
Flexible / Flexible with ferrule	mm ²
Tightening torque / Clamping screw	Nm
Blade size	

IEC 60947-7-3

Ex ec II C Gc II
3 G D

IEC	UL	CSA	EN 60079-7
500	300 (C)	300 (C)	
6.3	15	15	6.3
4	AWG 30...12	AWG 30...12	4 mm ²

6 kV / 3

V-0

© CE CB eUL VDE DEMK014ATEX1389U

Rated connection	
0.5...4 / 1.5...4	
0.5...4	
0.4...0.4 / (M 3)	
0.6 x 3.5 mm	

Note

Ordering data

Version	
	500 V AC/DC, without LED
	10-36 V AC/DC, with LED
	30-70 V AC/DC, with LED
	60-150 V AC/DC, with LED
	140-250 V AC/DC, with LED

Note

Type	Qty.	Order No.
WSI 4	50	2562590000
WSI 4/LD 10-36V AC/DC	50	2564350000
WSI 4/LD 30-70V AC/DC	50	2564360000
WSI 4/LD 60-150V AC/DC	50	2564370000
WSI 4/LD 140-250V AC/DC	50	2564380000

Accessories

End bracket	dark beige
Screwdriver	With "swifty set" cutting device Standard
G-fuse cartridge, 5 x 20 mm (IEC 60127-2)	0.25 A fast
	0.50 A fast
	1.00 A fast
	2.00 A fast
Marking tags	

Type	Qty.	Order No.
WEW 35/2	50	1061200000
SWIFTY SET	1	9006060000
SDS 0.6X3.5X100	1	2749340000
G 20/0.25A/F	0.25 A 10	0430500000
G 20/0.50A/F	0.5 A 10	0430600000
G 20/1.00A/F	1 A 10	0430700000
G 20/2.00A/F	2 A 10	0430900000
DEK 5/5 MC NE WS	1000	1609801044
WS 12/6 MC NE WS	600	1609900000

For detailed information on other accessories and application in the online catalogue



Screw connection with clamping yoke technology (W-Series)

Fuse terminal blocks

WSI 4/2

4 mm²

WSI 4/2

Overload and short-circuit protection

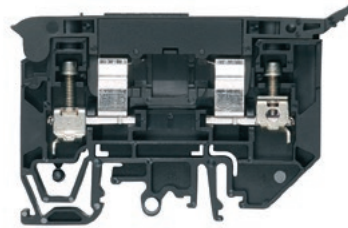

Width/Height/Depth	mm
max. current / max. cond. cross-section	A/mm ²
Max. clamping range	mm ²

9.1 x 81.6 x 53.5
6.3 / 6
0.5...6



Technical data

Rated data	
Rated voltage to adjoining terminal	V
Rated current	A
for wire cross-section	mm ²
Rated impulse withstand voltage / Pollution severity	
UL 94 flammability rating	
Approvals	
Clamped conductors (H05V/H07V)	
Solid / Stranded	mm ²
Flexible / Flexible with ferrule	mm ²
Tightening torque / Clamping screw	Nm
Blade size	

IEC 60947-7-3

IEC	UL	CSA	EN 60079-7
500	300 (C)	300 (C)	
6.3	15	15	
4	AWG 30...10	AWG 30...10	
6 kV / 3			
V-0			

CE

Rated connection	
Solid / Stranded	mm ²
Flexible / Flexible with ferrule	mm ²
Tightening torque / Clamping screw	Nm
Blade size	

Note

Ordering data

Version	
500 V AC/DC, without LED	
10-36 V AC/DC, with LED	
30-70 V AC/DC, with LED	
60-150 V AC/DC, with LED	
140-250 V AC/DC, with LED	

Note

Type	Qty.	Order No.
WSI 4/2	25	1880430000
WSI 4/2/LD 10-36V AC/DC	25	1880410000
WSI 4/2/LD 30-70V AC/DC	25	1880440000
WSI 4/2/LD 60-150V AC/DC	25	1880420000
WSI 4/2/LD 140-250V AC/DC	25	1880390000

Accessories

End plate / Partition plate	dark beige
End bracket	dark beige
Screwdriver	With "swifty set" cutting device Standard
Marking tags	

Type	Qty.	Order No.
WAP WSI4/2	50	1880450000
WEW 35/2	50	1061200000
SWIFTY SET	1	9006060000
SDS 0.6X3.5X100	1	2749340000
DEK 5/5 MC NE WS	1000	1609801044
WS 12/6 MC NE WS	600	1609900000

For detailed information on other accessories and application in the online catalogue

Type	Order No.
WSI 4/2	1880430000

Arrangement	Applications			
	Only short-circuit protection		Overload and short-circuit protection	
	T _A max.	Nominal values	T _A max.	Nominal values
Individual	55 °C	4.0 W / 10 A	35 °C	2.5 W / 2.5 A
In combination	68 °C	2.5 W / 2.5 A	41 °C	1.6 W / 1.0 A

WSI 6

6 mm²

WSI 6

Metric fuses

Overload and short-circuit protection

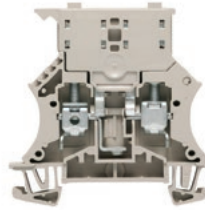

Width/Height/Depth	mm
max. current / max. cond. cross-section	A/mm ²
Max. clamping range	mm ²

7.9 x 60 x 61
6.3 / 10
0.5...10

Technical data

Rated data	
Rated voltage to adjoining terminal	V
Rated current	A
for wire cross-section	mm ²
Rated impulse withstand voltage / Pollution severity	
UL 94 flammability rating	
Approvals	
Clamped conductors (H05V/H07V)	
Solid / Stranded	mm ²
Flexible / Flexible with ferrule	mm ²
Tightening torque / Clamping screw	Nm
Blade size	

IEC 60947-7-3, IEC 60947-7-1

IEC	UL	CSA	EN 60079-7
500	600 (C)	600 (C)	
6.3	9.5	10	
6	AWG 22...8	AWG 20...8	
6 kV / 3			
V-0			

CE TÜV SÜD VDE

Rated connection	
0.5...10 / 1.5...10	
0.5...10 / 0.5...6	
0.8...1.6 / (M 3.5)	
0.8 x 4.0 mm	

Note

Ordering data

Version	
	500 V AC/DC, without LED
	10-36 V AC/DC, with LED
	30-70 V AC/DC, with LED
	60-150 V AC/DC, with LED
	140-250 V AC/DC, with LED
Note	

Type	Qty.	Order No.
WSI 6	50	1011000000
Note		

Accessories

Screwable cross-connection	
	2-pole
	10-pole
	Lock washer
	Mounting screw
End plate / Partition plate	
	dark beige
	dark beige
Screwdriver	
	Standard
End bracket	
	dark beige
G-fuse cartridge, 5 x 20 mm (IEC 60127-2)	
	0.25 A fast
	0.50 A fast
	1.00 A fast
	2.00 A fast
Marking tags	

Type	Qty.	Order No.
QL 2 SAK6N	41 A 50	0194300000
QL 10 SAK6N	41 A 20	0338300000
SS M3 D 128-A 3	50	0164400000
KISC M3X5	100	1052100000
WAP 2.5-10	50	1050000000
WAP 16+35 WTW 2.5-10	20	1050100000
SDS 0.8X4.0X100	1	2749360000
WEW 35/2	50	1061200000
G 20/0.25A/F	0.25 A 10	0430500000
G 20/0.50A/F	0.5 A 10	0430600000
G 20/1.00A/F	1 A 10	0430700000
G 20/2.00A/F	2 A 10	0430900000
DEK 5/8 MC NE WS	800	1856740000
WS 12/6.5 MC NE WS	540	1609920000
DEK 5/8 MM WS	500	2007130000
WS 8/8 MM WS	500	2007170000

Type	Order No.
WSI 6	1011000000

Arrangement	Applications			
	Only short-circuit protection		Overload and short-circuit protection	
	T _A max.	Nominal values	T _A max.	Nominal values
Individual	42 °C	4.0 W / 6.3 A	31 °C	1.6 W / 3.0 A
In combination	36 °C	2.5 W / 6.3 A	27 °C	1.6 W / 3.0 A

For detailed information on other accessories and application in the online catalogue



Screw connection with clamping yoke technology (W-Series)

Fuse terminal blocks

WSI 6 LED

6 mm²

Metric fuses / bipolar LED

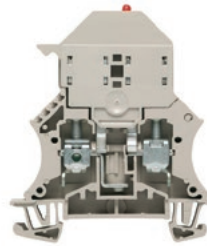

WSI 6 LED

Overload and short-circuit protection

Width/Height/Depth	mm
max. current / max. cond. cross-section	A/mm ²
Max. clamping range	mm ²

7.9 x 60 x 71.5
6.3 / 10
0.5...10

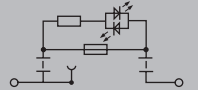

Technical data

Rated data	
Rated voltage to adjoining terminal	V
Rated current	A
for wire cross-section	mm ²
Rated impulse withstand voltage / Pollution severity	
UL 94 flammability rating	
Approvals	
Clamped conductors (H05V/H07V)	
Solid / Stranded	mm ²
Flexible / Flexible with ferrule	mm ²
Tightening torque / Clamping screw	Nm
Blade size	

IEC 60947-7-3

IEC	UL	CSA	EN 60079-7
500			
6.3			
6	AWG 22...8	AWG 20...8	
6 kV / 3			
V-0			

CE G B IEC 60947-7-3

Rated connection	
0.5...10 / 1.5...10	
0.5...10 / 0.5...6	
0.8...1.6 / (M 3.5)	
0.8 x 4.0 mm	

Note

Ordering data

Version	
	500 V AC/DC, without LED
	10-36 V AC/DC, with LED
	30-70 V AC/DC, with LED
	60-150 V AC/DC, with LED
	140-250 V AC/DC, with LED
Note	

Type	Qty.	Order No.
WSI 6/LD 10-36V DC/AC	10	1011300000
WSI 6/LD 30-70V DC/AC	10	1012200000
WSI 6/LD 60-150V DC/AC	10	1012300000
WSI 6/LD 250AC	10	1012400000

Accessories

Screwable cross-connection	
	2-pole
	10-pole
	Lock washer
	Mounting screw
End plate / Partition plate	
	dark beige
	dark beige
Screwdriver	
	Standard
End bracket	
	dark beige
G-fuse cartridge, 5 x 20 mm (IEC 60127-2)	
	0.25 A fast
	0.50 A fast
	1.00 A fast
	2.00 A fast
Marking tags	

Type	Qty.	Order No.
QL 2 SAK6N	41 A 50	0194300000
QL 10 SAK6N	41 A 20	0338300000
SS M3 D 128-A 3	50	0164400000
KISC M3X5	100	1052100000
WAP 2.5-10	50	1050000000
WAP 16+35 WTW 2.5-10	20	1050100000
SDS 0.8X4.0X100	1	2749360000
WEW 35/2	50	1061200000
G 20/0.25A/F	0.25 A 10	0430500000
G 20/0.50A/F	0.5 A 10	0430600000
G 20/1.00A/F	1 A 10	0430700000
G 20/2.00A/F	2 A 10	0430900000
DEK 5/8 MC NE WS	800	1856740000
WS 12/6.5 MC NE WS	540	1609920000
DEK 5/8 MM WS	500	2007130000
WS 8/8 MM WS	500	2007170000

For detailed information on other accessories and application in the online catalogue

Type	Order No.
WSI 6/LD 10-36V DC/AC	1011300000

Arrangement	Applications			
	Only short-circuit protection		Overload and short-circuit protection	
	T _A max.	Nominal values	T _A max.	Nominal values
Individual	42 °C	4.0 W / 6.3 A	31 °C	1.6 W / 3.0 A
In combination	36 °C	225 W / 6.3 A	27 °C	1.6 W / 3.0 A

WSI 6/2

6 mm²

Imperial fuses

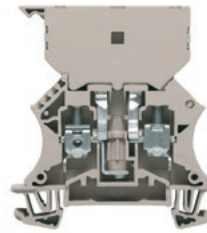

11.9 x 60 x 66.5
6.3 / 10
0.5...10



WSI 6/2

Overload and short-circuit protection

Width/Height/Depth	mm
max. current / max. cond. cross-section	A/mm ²
Max. clamping range	mm ²

Technical data

Rated data	
Rated voltage to adjoining terminal	V
Rated current	A
for wire cross-section	mm ²
Rated impulse withstand voltage / Pollution severity	
UL 94 flammability rating	
Approvals	
Clamped conductors (H05V/H07V)	
Solid / Stranded	mm ²
Flexible / Flexible with ferrule	mm ²
Tightening torque / Clamping screw	Nm
Blade size	

Note

Ordering data

Version	
	500 V AC/DC, without LED
	10-36 V AC/DC, with LED
	30-70 V AC/DC, with LED
	60-150 V AC/DC, with LED
	140-250 V AC/DC, with LED
Note	

Accessories

Screwable cross-connection	
	2-pole
	10-pole
	Lock washer
	Mounting screw
End plate / Partition plate	
	dark beige
	dark beige
Marking tags	

IEC 60947-7-3, IEC 60947-7-1

IEC	UL	CSA	EN 60079-7
500	600 (C)	150 (C)	
6.3	16	16	
6	AWG 22...8	AWG 20...6	
6 kV / 3			
V-0			

CE, RoHS, REACH, VDE, TÜV

Rated connection	
	0.5...10 / 1.5...10
	0.5...10 / 0.5...6
	0.8...1.6 / (M 3.5)
	0.8 x 4.0 mm

Type	Qty.	Order No.
WSI 6/2 GZ/DEF63	25	1014000000

Type	Qty.	Order No.
QL 2 SAK16	76 A 50	0470700000
QL 10 SAK16	76 A 20	0471000000
SS M3 D 128-A 3	50	0164400000
KISC M3x5	100	1052100000
WAP 2.5-10	50	1050000000
WAP 16+35 WTW 2.5-10	20	1050100000
DEK 5/8 MC NE WS	800	1856740000
WS 12/6.5 MC NE WS	540	1609920000

Type	Order No.
WSI 6/2 GZ/DEF63	1014000000

Arrangement	Applications			
	Only short-circuit protection		Overload and short-circuit protection	
	T _A max.	Nominal values	T _A max.	Nominal values
Individual	52 °C	4.0 W / 10.0 A	42 °C	2.5 W / 2.5 A
In combination	62 °C	2.5 W / 2.5 A	30 °C	2.5 W / 2.5 A

For detailed information on other accessories and application in the online catalogue

Screw connection with clamping yoke technology (W-Series)

Fuse terminal blocks

WSI 6/2 LED

6 mm²

Imperial fuses / bipolar LED

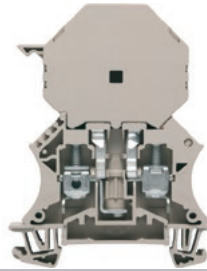

11.9 x 60 x 78.5

6.3 / 10

0.5...10

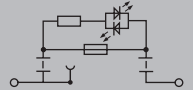

WSI 6/2 LED

Overload and short-circuit protection

Width/Height/Depth	mm
max. current / max. cond. cross-section	A/mm ²
Max. clamping range	mm ²

Technical data

Rated data	
Rated voltage to adjoining terminal	V
Rated current	A
for wire cross-section	mm ²
Rated impulse withstand voltage / Pollution severity	
UL 94 flammability rating	
Approvals	
Clamped conductors (H05V/H07V)	
Solid / Stranded	mm ²
Flexible / Flexible with ferrule	mm ²
Tightening torque / Clamping screw	Nm
Blade size	

Note

Ordering data

Version	
500 V AC/DC, without LED	
10-36 V AC/DC, with LED	
30-70 V AC/DC, with LED	
60-150 V AC/DC, with LED	
140-250 V AC/DC, with LED	

Note

Accessories

Screwable cross-connection	
2-pole	
10-pole	
Lock washer	
Mounting screw	

End plate / Partition plate	
dark beige	
dark beige	

Marking tags	

IEC 60947-7-3

IEC	UL	CSA	EN 60079-7
500			
6.3			
6	AWG 22...8	AWG 20...6	
	6 kV / 3		
	V-0		

CE CB CCC CUL

Rated connection	
0.5...10 / 1.5...10	
0.5...10 / 0.5...6	
0.8...1.6 / (M 3.5)	
0.8 x 4.0 mm	

Type	Qty.	Order No.
WSI 6/2/LD 10-36V DC/AC	25	1014100000
WSI 6/2/LD 30-70V DC/AC	25	1014200000
WSI 6/2/LD 60-150VDC/AC	25	1014300000
WSI 6/2/LD 250AC	25	1014400000

Type	Qty.	Order No.
QL 2 SAK16	76 A 50	0470700000
QL 10 SAK16	76 A 20	0471000000
SS M3 D 128-A 3	50	0164400000
KISC M3x5	100	1052100000
WAP 2.5-10	50	1050000000
WAP 16+35 WTW 2.5-10	20	1050100000
DEK 5/8 MC NE WS	800	1856740000
WS 12/6.5 MC NE WS	540	1609920000

Type	Order No.
WSI 6/2/LD 10-36V DC/AC	1014100000

Arrangement	Applications			
	Only short-circuit protection		Overload and short-circuit protection	
	T _A max.	Nominal values	T _A max.	Nominal values
Individual	52 °C	4.0 W / 10.0 A	42 °C	2.5 W / 2.5 A
In combination	62 °C	2.5 W / 2.5 A	30 °C	2.5 W / 2.5 A

For detailed information on other accessories and application in the online catalogue

WSI 6/LD LLC

6 mm²

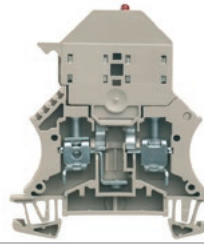

Width/Height/Depth	mm
max. current / max. cond. cross-section	A/mm ²
Max. clamping range	mm ²

7.9 x 60 x 71.5
6.3 / 10
0.5...10

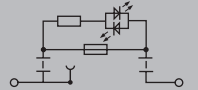

Technical data

Rated data	
Rated voltage to adjoining terminal	V
Rated current	A
for wire cross-section	mm ²
Rated impulse withstand voltage / Pollution severity	
UL 94 flammability rating	
Approvals	
Clamped conductors (H05V/H07V)	
Solid / Stranded	mm ²
Flexible / Flexible with ferrule	mm ²
Tightening torque / Clamping screw	Nm
Blade size	

IEC 60947-7-3

IEC	UL	CSA	EN 60079-7
500			
6.3			
6	AWG 22...8	AWG 20...8	
			/ 3
			V-0

CE 0100000000

Rated connection	
Solid / Stranded	mm ²
Flexible / Flexible with ferrule	mm ²
Tightening torque / Clamping screw	Nm
Blade size	

Note

Ordering data

Version	
	10-36 V AC/DC, with LED
	30-70 V AC/DC, with LED
	60-150 V AC/DC, with LED
	140-250 V AC/DC, with LED

Note

Type	Qty.	Order No.
WSI 6/LD 10-36V LLC	10	1119840000
WSI 6/LD 30-70V LLC	10	1119830000
WSI 6/LD 60-150V LLC	10	1119850000
WSI 6/LD 250AC LLC	10	1119870000

Accessories

Screwable cross-connection	
	2-pole
	10-pole
	Mounting screw

End plate / Partition plate	
	dark beige
	dark beige

End bracket	
	dark beige

G-fuse cartridge, 5 x 20 mm (IEC 60127-2)	
	0.25 A fast
	0.50 A fast
	1.00 A fast
	2.00 A fast

Screwdriver	
	Standard

Marking tags

Type	Qty.	Order No.
QL 2 SAK6N	41 A 50	0194300000
QL 10 SAK6N	41 A 20	0338300000
KISC M3X20 SAK10 CU5	100	0377100000

WAP 2.5-10	50	1050000000
WAP 16+35 WTW 2.5-10	20	1050100000

WEW 35/2	50	1061200000
----------	----	------------

G 20/0.25A/F	0.25 A	10	0430500000
G 20/0.50A/F	0.5 A	10	0430600000
G 20/1.00A/F	1 A	10	0430700000
G 20/2.00A/F	2 A	10	0430900000

SDS 0.8X4.0X100	1	2749360000
-----------------	---	------------

DEK 5/8 MC NE WS	800	1856740000
WS 12/6.5 MC NE WS	540	1609920000
DEK 5/8 MM WS	500	2007130000
WS 8/8 MM WS	500	2007170000

For detailed information on other accessories and application in the online catalogue



Screw connection with clamping yoke technology (W-Series)

Fuse terminal blocks

WSI 6/2/LD LLC

6 mm²

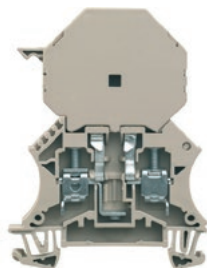

Width/Height/Depth	mm
max. current / max. cond. cross-section	A/mm ²
Max. clamping range	mm ²

11.9 x 60 x 78.5
6.3 / 10
0.5...10

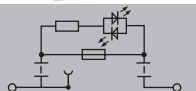

Technical data

Rated data	
Rated voltage to adjoining terminal	V
Rated current	A
for wire cross-section	mm ²
Rated impulse withstand voltage / Pollution severity	
UL 94 flammability rating	
Approvals	
Clamped conductors (H05V/H07V)	
Solid / Stranded	mm ²
Flexible / Flexible with ferrule	mm ²
Tightening torque / Clamping screw	Nm
Blade size	

IEC 60947-7-3

IEC	UL	CSA	EN 60079-7
500			
6.3			
6	AWG 22...8	AWG 20...8	
			/ 3
			V-0

CE G B K

Rated connection	
Solid / Stranded	mm ²
Flexible / Flexible with ferrule	mm ²
Tightening torque / Clamping screw	Nm
Blade size	

Note

Ordering data

Version	
	10-36 V AC/DC, with LED
	30-70 V AC/DC, with LED
	60-150 V AC/DC, with LED
	140-250 V AC/DC, with LED

Type	Qty.	Order No.
WSI 6/2/LD 10-36V LLC	25	1119800000
WSI 6/2/LD 30-70V LLC	25	1119810000
WSI 6/2/LD 60-150V LLC	25	1119820000
WSI 6/2/LD 250AC LLC	25	1119790000

Note

Accessories

Screwable cross-connection	
	2-pole
	10-pole
	Lock washer
	Mounting screw
End plate / Partition plate	
	dark beige
	dark beige
End bracket	
	dark beige
Screwdriver	
	Standard
Marking tags	

Type	Qty.	Order No.
QL 2 SAK16	76 A 50	0470700000
QL 10 SAK16	76 A 20	0471000000
SS M3 D 128-A 3	50	0164400000
KISC M3X5	100	1052100000
WAP 2.5-10	50	1050000000
WAP 16*35 WTW 2.5-10	20	1050100000
WEW 35/2	50	1061200000
SDS 0.8X4.0X100	1	2749360000
DEK 5/8 MC NE WS	800	1856740000
WS 12/6.5 MC NE WS	540	1609920000

For detailed information on other accessories and application in the online catalogue



WSI 25 10x38

25 mm²

WSI 25 CC

25 mm²



Width/Height/Depth	mm
max. current / max. cond. cross-section	A/mm ²
Max. clamping range	mm ²

18 x 81 x 58
32 / 25
1.5...25



18 x 81 x 58
32 / 25
1.5...25



Technical data

Rated data	
Rated voltage to adjoining terminal	V
Rated current	A
for wire cross-section	mm ²
Rated impulse withstand voltage / Pollution severity	
UL 94 flammability rating	
Approvals	
Clamped conductors (H05V/H07V)	
Solid / Stranded	mm ²
Flexible / Flexible with ferrule	mm ²
Tightening torque / Clamping screw	Nm
Blade size	

IEC 60947-7-3			
IEC	UL	CSA	EN 60079-7
690			
32			
25		AWG 18...3	
		6 kV / 3	
		V-0	
CE CB CB			
Rated connection			
1.5...25 / 1.5...25			
1.5...25 / 1.5...25			
2...2.5 /			

IEC 60947-7-3			
IEC	UL	CSA	EN 60079-7
690			
32			
25		AWG 18...3	
		6 kV / 3	
		V-0	
CE CB CB			
Rated connection			
1.5...25 / 1.5...25			
1.5...25 / 1.5...25			
2...2.5 /			

Note

Ordering data

Version	
1-pole, without LED	
2-pole, without LED	
3-pole, without LED	
1-pole, with LED	

Note

Accessories

Marking tags	
Marking tags	
End bracket	
dark beige	

Type	Qty.	Order No.
WSI 25/1 10X38	12	1966020000
WSI 25/2 10X38	6	1966090000
WSI 25/3 10X38	4	1966080000
WSI 25/1 10X38/LED 690V	12	1966060000

Type	Qty.	Order No.
ESG 6/15 K MC NE WS	200	1880100000
WEW 35/2	50	1061200000

Type	Qty.	Order No.
WSI 25/1 CC	12	1966050000
WSI 25/2 CC	6	1966040000
WSI 25/3 CC	4	1966030000
WSI 25/1 CC/LED	12	1966070000

Type	Qty.	Order No.
ESG 6/15 K MC NE WS	200	1880100000
WEW 35/2	50	1061200000

For detailed information on other accessories and application in the online catalogue



Screw connection with clamping yoke technology (W-Series)

Fuse terminal blocks

WSI 25/1 10x38 1KV

25 mm²



Width/Height/Depth	mm
max. current / max. cond. cross-section	A/mm ²
Max. clamping range	mm ²

18 x 81 x 58
30 / 25
1.5...25

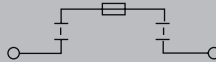

Technical data

Rated data	
Rated voltage to adjoining terminal	V
Rated current	A
for wire cross-section	mm ²
Rated impulse withstand voltage / Pollution severity	
UL 94 flammability rating	
Approvals	
Clamped conductors (H05V/H07V)	
Solid / Stranded	mm ²
Flexible / Flexible with ferrule	mm ²
Tightening torque / Clamping screw	Nm
Blade size	

IEC 60269-1

IEC	UL	CSA	EN 60079-7
1000			
30			
25		AWG 18...8	
		6 kV / 3	
		V-0	

CE   

Rated connection	
1.5...25 / 1.5...25	
1.5...25 / 1.5...25	
2...2.5 /	

Note

Ordering data

Version	
	1-pole, without LED
	1-pole, with LED

Note

Type	Qty.	Order No.
WSI 25/1 10X38 1KV	12	1137790000
WSI 25/1 10X38/LED 1KV	12	1137780000

For detailed information on other accessories and application in the online catalogue



SAKS 2/35 DB

10 mm²

D fuses E 16



27.6 x 80 x 73.5
10 / 16
0.22...16



SAKS 4/35 DB

10 mm²

D 01 fuses E 14



24 x 75 x 65
16 / 16
0.22...16



Width/Height/Depth mm
max. current / max. cond. cross-section A/mm²
Max. clamping range mm²

Technical data

Rated data	
Rated voltage to adjoining terminal	V
Rated current	A
for wire cross-section	mm ²
Rated impulse withstand voltage / Pollution severity	
UL 94 flammability rating	
Approvals	
Clamped conductors (H05V/H07V)	
Solid / Stranded	mm ²
Flexible / Flexible with ferrule	mm ²
Tightening torque / Clamping screw	Nm
Blade size	

Note

Ordering data

Version	
	500 V AC/DC, without LED
Note	

Accessories

Screwable cross-connection	
	2-pole
	10-pole
	Lock washer
Mounting screw	
	Mounting screw
	dark beige
End plate / Partition plate	
	dark beige
Screw cover cap	
	SK
Safety fuses	
Gauge rings	
Marking tags	

For detailed information on other accessories and application in the online catalogue

IEC 60947-7-3

IEC	UL	CSA	EN 60079-7
500		600 (C)	
10		25	
10		AWG 22...8	
6 kV / 3			
V-0, 5VA			

CE

Rated connection	
0.5...16 / 0.5...10	
0.5...10	
1.2...2.4 / (M 4)	
1.0 x 5.5 mm	

Type	Qty.	Order No.
SAKS 2/35 DB	20	1368700000

Type	Qty.	Order No.
QL 2 SAKS2	36 A 20	0207800000
QL 10 SAKS2	36 A 20	0338900000
SS M4 D 128-A 4	100	0136400000
BFSC M4X9T	100	0103300000
WTW EN	20	1058800000
SK E16/SAKS2	25	0284110000
E 16/10A RT TNDZ	10 A 25	0208500000
E 16/16A GR TNDZ	16 A 25	0208600000
E 16/20A BL TNDZ	20 A 25	0208700000
E 16/25A GE TNDZ	25 A 25	0208800000
DEK 5/5 MC NE WS	1000	1609801044

IEC 60947-7-3

IEC	UL	CSA	EN 60079-7
400	600 (C)	600 (C)	
16	30	30	
10	AWG 26...8	AWG 22...8	
6 kV / 3			
V-0, 5VA			

CE

Rated connection	
0.5...16 / 0.5...10	
0.5...10	
1.2...2.4 / (M 4)	
1.0 x 5.5 mm	

Type	Qty.	Order No.
SAKS 4/35 DB	20	0501800000

Type	Qty.	Order No.
QL 2 SAKS4	47 A 20	0328000000
QL 10 SAKS4	47 A 20	0339000000
SS M4 D 128-A 4	100	0136400000
BFSC M4X9T	100	0103300000
WTW EN	20	1058800000
SK E14 SAKS4	20	0339410000
E 14/2A RS	2 A 10	0137400000
E 14/4A BR	4 A 10	0137500000
E 14/6A GN	6 A 10	0328300000
E 14/10A RT	10 A 10	0328400000
P 14/2 D01 RS SAKS4	2 A 50	0138000000
P 14/4 D01 BR SAKS4	4 A 50	0138100000
DEK 5/5 MC NE WS	1000	1609801044

For detailed information on other accessories and application in the online catalogue



Screw connection with clamping yoke technology (W-Series)

Fuse terminal blocks

SAKS 5/35 DB

16 mm²

D 02 fuse E 18



Width/Height/Depth	mm
max. current / max. cond. cross-section	A/mm ²
Max. clamping range	mm ²

28 x 80 x 65
63 / 16
1.5...16

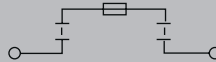

Technical data

Rated data	
Rated voltage to adjoining terminal	V
Rated current	A
for wire cross-section	mm ²
Rated impulse withstand voltage / Pollution severity	
UL 94 flammability rating	
Approvals	
Clamped conductors (H05V/H07V)	
Solid / Stranded	mm ²
Flexible / Flexible with ferrule	mm ²
Tightening torque / Clamping screw	Nm
Blade size	

IEC 60947-7-3

IEC	UL	CSA	EN 60079-7
400	600 (C)	600 (C)	
63	40	63	
16	AWG 14...6	AWG 14...6	
6 kV / 3			
V-0, 5VA			

CE G B T

Rated connection	
Solid / Stranded	mm ²
Flexible / Flexible with ferrule	mm ²
Tightening torque / Clamping screw	Nm
Blade size	

Note

Ordering data

Version	500 V AC/DC, without LED
Note	

Type	Qty.	Order No.
SAKS 5/35 DB	20	0502100000

Accessories

Screwable cross-connection	
	2-pole
	10-pole
	Lock washer
Mounting screw	Mounting screw
End plate / Partition plate	dark beige
Screw cover cap	SK
Safety fuses	
Gauge rings	
Marking tags	

Type	Qty.	Order No.
QL 2 SAKS2	36 A 20	0207800000
QL 10 SAKS2	36 A 20	0338900000
SS M4 D 128-A 4	100	0136400000
BFSC M4X9T	100	0103300000
WTW EN	20	1058800000
SK E18 SAKS5	20	0359310000
E 18/20A BL	20 A 10	0361300000
E 18/25A GE	25 A 10	0361400000
E 18/35A SW	35 A 10	0361500000
P 18/20 D02 BL SAKS5	20 A 50	0361800000
P 18/25 D02 GE SAKS5	25 A 50	0361900000
P 18/35 D02 SW SAKS5	35 A 50	0362000000
P 18/50 D02 WS SAKS5	50 A 50	0362100000
DEK 5/5 MC NE WS	1000	1609801044

For detailed information on other accessories and application in the online catalogue



WTR 2.5/SI

2.5 mm²



Width/Height/Depth	mm
max. current / max. cond. cross-section	A/mm ²
Max. clamping range	mm ²

5.1 x 60 x 97
6.3 / 4
0.05...4

Technical data

Rated data	
Rated voltage to adjoining terminal	V
Rated current	A
for wire cross-section	mm ²
Rated impulse withstand voltage / Pollution severity	
UL 94 flammability rating	
Approvals	
Clamped conductors (H05V/H07V)	
Solid / Stranded	mm ²
Flexible / Flexible with ferrule	mm ²
Tightening torque / Clamping screw	Nm
Blade size	

IEC 60947-7-3

IEC	UL	CSA	EN 60079-7
400		300 (D)	
6.3		10	
2.5	AWG 22...12	AWG 26...12	
6 kV / 3			
V-0			

CE

Rated connection	
0.5...4 / 1.5...4	
0.5...4 / 0.5...2.5	
0.4...0.8 / (M 2.5)	
0.6 x 3.5 mm	

Note

Ordering data

Version	
	400 V AC/DC, without LED
	10-36 V AC/DC, with LED

Note

Type	Qty.	Order No.
WTR 2.5/SI	25	1763940000
WTR 2.5/SI LD 36V	25	1763950000

Accessories

Plug-in cross-connection	
	2-pole
	10-pole
End plate / Partition plate	
	dark beige
	dark beige
G-fuse cartridge, 5 x 20 mm (IEC 60127-2)	
	0.25 A fast
	0.50 A fast
	1.00 A fast
	2.00 A fast
Screwdriver	
	Standard
Marking tags	

Type	Qty.	Order No.
ZQV 2.5N/2	24 A 60	1527540000
ZQV 2.5N/10	24 A 20	1527690000
WAP 2.5-10	50	1050000000
WAP 16*35 WTW 2.5-10	20	1050100000
G 20/0.25A/F	0.25 A 10	0430500000
G 20/0.50A/F	0.5 A 10	0430600000
G 20/1.00A/F	1 A 10	0430700000
G 20/2.00A/F	2 A 10	0430900000
SDS 0.6X3.5X100	1	2749340000
DEK 5/5 MC NE WS	1000	1609801044
WS 12/5 MC NE WS	720	1609860000
DEK 5/5 MM WS	800	2007110000
WS 8/5 MM WS	800	2007150000

For detailed information on other accessories and application in the online catalogue



Screw connection with clamping yoke technology (W-Series)

Fuse terminal blocks

WTR 4 SI SL

4 mm²

With fuse holder

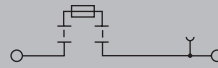
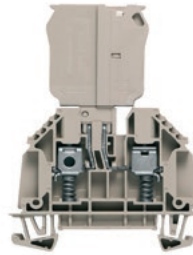

Width/Height/Depth	mm
max. current / max. cond. cross-section	A/mm ²
Max. clamping range	mm ²

6.1 x 61.5 x 97
6.3 / 6
0.22...6

Technical data

Rated data	
Rated voltage to adjoining terminal	V
Rated current	A
for wire cross-section	mm ²
Rated impulse withstand voltage / Pollution severity	
UL 94 flammability rating	
Approvals	
Clamped conductors (H05V/H07V)	
Solid / Stranded	mm ²
Flexible / Flexible with ferrule	mm ²
Tightening torque / Clamping screw	Nm
Blade size	

IEC 60947-7-1

IEC	UL	CSA	EN 60079-7
400	300 (D)	300 (D)	
6.3	6.3	6.3	
4	AWG 22...10	AWG 22...10	
6 kV / 3			
V-0			

CE

Rated connection	
0.5...6 / 1.5...6	
0.5...4	
0.5...1 / (M 3)	
0.6 x 3.5 mm	

Note

Ordering data

Version	
	400 V AC/DC, without LED
Note	

Type	Qty.	Order No.
WTR 4 SI SL	25	7910330000

Accessories

Plug-in cross-connection	
	2-pole
	10-pole
End plate / Partition plate	
	dark beige
	Black
	dark beige
G-fuse cartridge, 5 x 20 mm (IEC 60127-2)	
	0.25 A fast
	0.50 A fast
	1.00 A fast
	2.00 A fast
End bracket	
	dark beige
Hak. Cable lugs	
Marking tags	

Type	Qty.	Order No.
ZQV 4N/2	32 A 60	1527930000
ZQV 4N/10	32 A 20	1528090000
WAP 2.5-10	50	1050000000
WAP 2.5-10 SW	50	1050010000
WAP 16*35 WTW 2.5-10	20	1050100000
G 20/0.25A/F	0.25 A 10	0430500000
G 20/0.50A/F	0.5 A 10	0430600000
G 20/1.00A/F	1 A 10	0430700000
G 20/2.00A/F	2 A 10	0430900000
WEW 35/2	50	1061200000
HBT 1,5 - 3,0 RT	100	1312440000
HBT 2,5 - 3,0 BL	100	1312450000
DEK 5/6 MC NE WS	1000	1609820000
WS 12/6 MC NE WS	600	1609900000
DEK 5/6 MM WS	600	2007120000

For detailed information on other accessories and application in the online catalogue

KDKS 1/35 DB

4 mm²

Metric fuses 5 x 20 mm

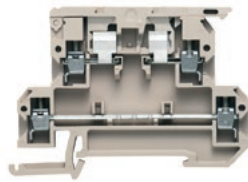

KDKS 1EN/LLC

4 mm²



Width/Height/Depth	mm
max. current / max. cond. cross-section	A/mm ²
Max. clamping range	mm ²

8 x 73.5 x 55.6	
6.3 / 4	
0.22...4	

8 x 76.5 x 54.6	
/ 4	
0.22...4	

Technical data

Rated data	
Rated voltage to adjoining terminal	V
Rated current	A
for wire cross-section	mm ²
Rated impulse withstand voltage / Pollution severity	
UL 94 flammability rating	
Approvals	
Clamped conductors (H05V/H07V)	
Solid / Stranded	mm ²
Flexible / Flexible with ferrule	mm ²
Tightening torque / Clamping screw	Nm
Blade size	

IEC 60947-7-3			
IEC	UL	CSA	EN 60079-7
500	300 (C)	300 (D)	
6.3	10	10	
4	AWG 26...12	AWG 26...12	
6 kV / 3			
V-0			
CE			
Rated connection			
0.5...4 / 1.5...4			
0.5...4			
0.5...0.8 / (M 3)			
0.6 x 3.5 mm			

IEC 60947-7-3			
IEC	UL	CSA	EN 60079-7
500	300 (C)	150 (C)	
6.3	20	25	
4	AWG 26...12	AWG 26...12	
/ 3			
V-0			
CE			
Rated connection			
0.5...4 / 1.5...4			
0.5...4			
0.5...0.8 / (M 3)			
0.6 x 3.5 mm			

Note

Ordering data

Version	500 V AC/DC, without LED 10-36 V AC/DC, with LED 30-70 V AC/DC, with LED 60-150 V AC/DC, with LED 100 - 250 V AC/DC, with LED
Note	

Type	Qty.	Order No.
KDKS 1/35 DB	50	9532440000

Type	Qty.	Order No.
KDKS 1EN/LLC 10-36V AC/DC	50	9802720001
KDKS 1EN/LLC 30-70V AC/DC	50	9908510001
KDKS 1EN/LLC 100-250V AC/DC	50	9915820001

Accessories

End plate / Partition plate	dark beige
G-fuse cartridge, 5 x 20 mm (IEC 60127-2)	0.25 A fast 0.50 A fast 1.00 A fast 2.00 A fast
Marking tags	

Type	Qty.	Order No.
AP KDKS1 DB	20	9532470000
G 20/0.25A/F	0.25 A 10	0430500000
G 20/0.50A/F	0.5 A 10	0430600000
G 20/1.00A/F	1 A 10	0430700000
G 20/2.00A/F	2 A 10	0430900000
DEK 5/8 MC NE WS	800	1856740000

Type	Qty.	Order No.
AP KDKS1 DB	20	9532470000
G 20/0.25A/F	0.25 A 10	0430500000
G 20/0.50A/F	0.5 A 10	0430600000
G 20/1.00A/F	1 A 10	0430700000
G 20/2.00A/F	2 A 10	0430900000
DEK 5/8 MC NE WS	800	1856740000

For detailed information on other accessories and application in the online catalogue

Screw connection with clamping yoke technology (W-Series)

Fuse terminal blocks

KDKS 1PE/LLC

4 mm²

KDKS 1/35 DB

Overload and short-circuit protection

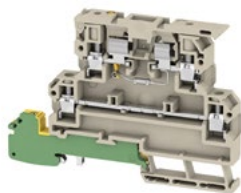

Width/Height/Depth	mm
max. current / max. cond. cross-section	-/mm ²
Max. clamping range	mm ²

8 x 91 x 65	
/ 4	
0.33...4	

IEC 60947-7-1, IEC 60947-7-2, IEC 60947-7-3

Technical data

Rated data	
Rated voltage to adjoining terminal	V
Rated current	A
for wire cross-section	mm ²
Rated impulse withstand voltage / Pollution severity	
UL 94 flammability rating	
Approvals	
Clamped conductors (H05V/H07V)	
Solid / Stranded	mm ²
Flexible / Flexible with ferrule	mm ²
Tightening torque / Clamping screw	Nm
Blade size	

IEC	UL	CSA	EN 60079-7
500	300 (C)	150 (C)	
6.3	20	25	
4	AWG 26...12	AWG 26...12	
6 kV / 3			
V-0			

CE

Rated connection	
0.5...4 / 1.5...4	
0.5...4	
0.5...1 / (M 3)	
0.6 x 3.5 mm	

Note

Ordering data

Version
500 V AC/DC, without LED
10-36 V AC/DC, with LED
30-70 V AC/DC, with LED
60-150 V AC/DC, with LED
100 - 250 V AC/DC, with LED
Note

Type	Qty.	Order No.
KDKS 1PE/LLC 10-36V AC/DC	50	1518300000
KDKS 1PE/LLC 30-70V AC/DC	50	1518330000
KDKS 1PE/LLC 60-150V AC/DC	50	1518340000
KDKS 1PE/LLC 100-250V AC/DC	50	1518370000

Accessories

End plate / Partition plate	
	dark beige
G-fuse cartridge, 5 x 20 mm (IEC 60127-2)	
0.25 A fast	
0.50 A fast	
1.00 A fast	
2.00 A fast	
Marking tags	

Type	Qty.	Order No.
AP KDKS1 DB	20	9532470000
G 20/0.25A/F	0.25 A 10	0430500000
G 20/0.50A/F	0.5 A 10	0430600000
G 20/1.00A/F	1 A 10	0430700000
G 20/2.00A/F	2 A 10	0430900000
DEK 5/8 MC NE WS	800	1856740000

Type	Order No.
KDKS 1/35 DB	9532440000

Arrangement	Applications			
	Only short-circuit protection		Overload	
	T _A max.	Nominal values	T _A max.	Nominal values
Individual	23 °C*	4.0 W / 10 A*	41 °C	1.6 W / 6.3 A
In combination	50 °C*	1.6 W / 6.3 A	23 °C	1.6 W / 6.3 A

*) Values not available → The values specified were not measured but instead read from the derating curves and transferred to the "only short-circuit protection" operating mode.

For detailed information on other accessories and application in the online catalogue



Fuse cartridges

Technical data

for terminal type:
 PSI 6/10
 WSI 4
 WSI 6
 AFS 4 2C BK
 PSI 6/10 SW
 ZSI 2.5
 ZSI 2.5-2/2X2AN/G20
 ZSI 6-2 2X2.5/G20
 KDKS 1/35 DB



Ordering data

G-type fuse cartridges 5 x 20 without indicator in accordance with IEC 60127-2 (VDE 0820 T.2 BI) ¹⁾						
Size (mm)	Rated current	Characteristics	Type	Qty.	Order No.	
Cartridge fuse Rated breaking capacity	G-Si. 5 x 20 1.5 kA	0.1	quick-acting	G 20/0.10A/F	10	0430300000
		0.2	quick-acting	G 20/0.20A/F	10	0430400000
		0.25	quick-acting	G 20/0.25A/F	10	0430500000
		0.5	quick-acting	G 20/0.50A/F	10	0430600000
		0.63	quick-acting	G 20/0.63A/F	10	0439000000
		1	quick-acting	G 20/1.00A/F	10	0430700000
		1.6	quick-acting	G 20/1.60A/F	10	0430800000
		2	quick-acting	G 20/2.00A/F	10	0430900000
		2.5	quick-acting	G 20/2.50A/F	10	0431000000
		3.15	quick-acting	G 20/3.15A/F	10	0431100000
		4	quick-acting	G 20/4.00A/F	10	0431200000
5	quick-acting	G 20/5.00A/F	10	0431300000		
6.3	quick-acting	G 20/6.30A/F	10	0431400000		

(M) = medium time-lag; (F) = quick-acting

Technical data

for terminal type:
 WSI 6



Ordering data

G-type fuse cartridges 5 x 25 with code in acc. with DIN 41576 ¹⁾						
Size (mm)	Rated current	Characteristics	Type	Qty.	Order No.	
Cartridge fuse Rated breaking capacity	G-Si. 5 x 25 80 A	0.25	medium time-lag	G 25/0.25A/M GE	10	0546900000
		0.5	medium time-lag	G 25/0.50A/M WS	10	0510300000
		0.8	medium time-lag	G 25/0.80A/M GR	10	0646400000
		1	medium time-lag	G 25/1.00A/M RT	10	0265800000
		2	quick-acting	G 25/2.00A/F BL	10	0192700000
		4	quick-acting	G 25/4.00A/F BR	10	0192800000
		6.3	quick-acting	G 25/6.30A/F GN	10	0192900000
		10	medium time-lag	G 25/10.0A/M RT	10	0193100000

(M) = medium time-lag; (F) = quick-acting

Technical data

for terminal type:
 WSI 4/2
 WSI 6/2 GZ/DEF63



Ordering data

Fuse cartridges 1/4" x 1/4" without indicator in acc. with BS 88						
Size (mm)	Rated current	Characteristics	Type	Qty.	Order No.	
Cartridge fuse Rated breaking capacity	G-Si. 6.3 x 32 50 kA	0.5	quick-acting	GZ 0.5A/F	10	1460580000
		1	quick-acting	GZ 1.0A/F	10	1460590000
		2	quick-acting	GZ 2.0A/F	10	1460600000
		3	quick-acting	GZ 3.0A/F	10	1460610000
		5	quick-acting	GZ 5.0A/F	10	1460620000
		7	quick-acting	GZ 7.0A/F	10	1460630000
		10	quick-acting	GZ 10.0A/F	10	1460640000
		12.5	quick-acting	GZ 12.5A/F	10	1460650000

(M) = medium time-lag; (F) = quick-acting

Technical data

for terminal type:
 SAKS 2/35 DB



Ordering data

D-type fuse cartridge E 16 with indicator in acc. with DIN 49360 (Diazed)						
Size (mm)	Rated current	Characteristics	Type	Qty.	Order No.	
Cartridge fuse Rated breaking capacity	25	10	slo-blo	E 16/10A RT TNDZ	25	0208500000
		16	slo-blo	E 16/16A GR TNDZ	25	0208600000
		20	slo-blo	E 16/20A BL TNDZ	25	0208700000
		25	slo-blo	E 16/25A GE TNDZ	25	0208800000

(M) = medium time-lag; (F) = quick-acting

Technical data

for terminal type:
 SAKS 4/35 DB



Ordering data

D-type fuse cartridges E 14 size D 01 and E 18 size D 02 with indicator in acc. with DIN 49522 (Neozed) ³⁾						
Size (mm)	Rated current	Characteristics	Type	Qty.	Order No.	
Cartridge fuse Rated breaking capacity	25	10	slo-blo	E 14/10A RT	10	0328400000
		16	slo-blo	E 14/16A GR	10	0328500000
		2	slo-blo	E 14/2A RS	10	0137400000
		4	slo-blo	E 14/4A BR	10	0137500000
		6	slo-blo	E 14/6A GN	10	0328300000

(M) = medium time-lag; (F) = quick-acting

Fuse cartridges

Technical data

for terminal type:
SAKS 5/35 DB



Ordering data

D-type fuse cartridges E 14 size D 01 and E 18 size D 02 with indicator in acc. with DIN 49522 (Neozed)³⁾

Size (mm)	Rated current	Characteristics	Type	Qty.	Order No.
	20	slo-blo	E 18/20A BL	10	0361300000
	25	slo-blo	E 18/25A GE	10	0361400000
Cartridge fuse	35	slo-blo	E 18/35A SW	10	0361500000
Rated breaking capacity	50	slo-blo	E 18/50A WS	10	0361600000
	63	slo-blo	E 18/63A KU	10	0361700000

(M) = medium time-lag; (F) = quick-acting

- 1) The company SIBA supplies G-type fuse cartridges 5 x 25 with indicator, also in marine engineering version for 450 V~.
- 2) Fuse cartridges 5 x 30 (500 V~) für SAKS 3 are available from the company WICKMANN.
- 3) The company LINDNER supplies Neozed fuse cartridges, also in a further marine engineering version for 440 V~.
- 4) Fuse cartridges with the dimensions 1"x1/4" = 25.4x6.35 mm and 13/32"x11/2" = 10.3x38.1 mm are not in the programme.
- 5) Only for SAKS 1 and SAKS 7.

Gauge rings

Technical data

for terminal type:
SAKS 4/35 DB



Ordering data

Type	Cartridge fuse	Current	Colour	Qty.	Order No.
P 14/2 D01 RS SAKS4	E14 / 2	2 A	pink	50	0138000000
P 14/4 D01 BR SAKS4	E14 / 4	4 A	brown	50	0138100000
P 14/6 D01 GN SAKS4	E14 / 6	6 A	green	50	0328600000
P 14/10 D01 RT SAKS4	E14 / 10	10 A	red	50	0328700000

Technical data

for terminal type:
SAKS 5/35 DB



Ordering data

Type	Cartridge fuse	Current	Colour	Qty.	Order No.
P 18/20 D02 BL SAKS5	E18 / 20	20 A	blue	50	0361800000
P 18/25 D02 GE SAKS5	E18 / 25	25 A	yellow	50	0361900000
P 18/35 D02 SW SAKS5	E18 / 35	35 A	black	50	0362000000
P 18/50 D02 WS SAKS5	E18 / 50	50 A	white	50	0362100000



Separate potentials simply and safely in confined spaces

Klippon® Connect test-disconnect terminal blocks

In marshalling cabinets of industrial control systems, signal lines from the field are often connected with terminal blocks. These are known as a robust, simple, and tidy connection option. However, their use requires sufficient current protection and a reliable disconnection circuit.

Our WDTR test-disconnect terminal blocks enable a safe and simple electrical isolation in confined spaces. Two potentials can be operated with only one terminal block, resulting in space-savings of 50%. The multifunctional disconnect section can be converted into a fuse terminal or equipped with a component plug to enable the integration of electronic components.

Your special advantages:

- Separation of two different potentials on one terminal block
- Maximum safety due to colour-contrasted disconnect levers
- Combination foot for maximum flexibility on TS 32 and TS 35 mounting rails
- Multifunctional separation area for individual applications

Space-saving on the mounting rail

The design of the terminal block makes it possible to switch two potentials with only one terminal. This results in a space-savings of 50 % compared to conventional superstructures.



Increased clarity and security

The two potentials are marked in different colours and assigned to the connection areas. This reduces the risk of misconnections and guarantees maximum safety.

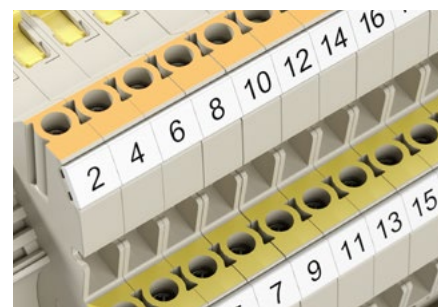

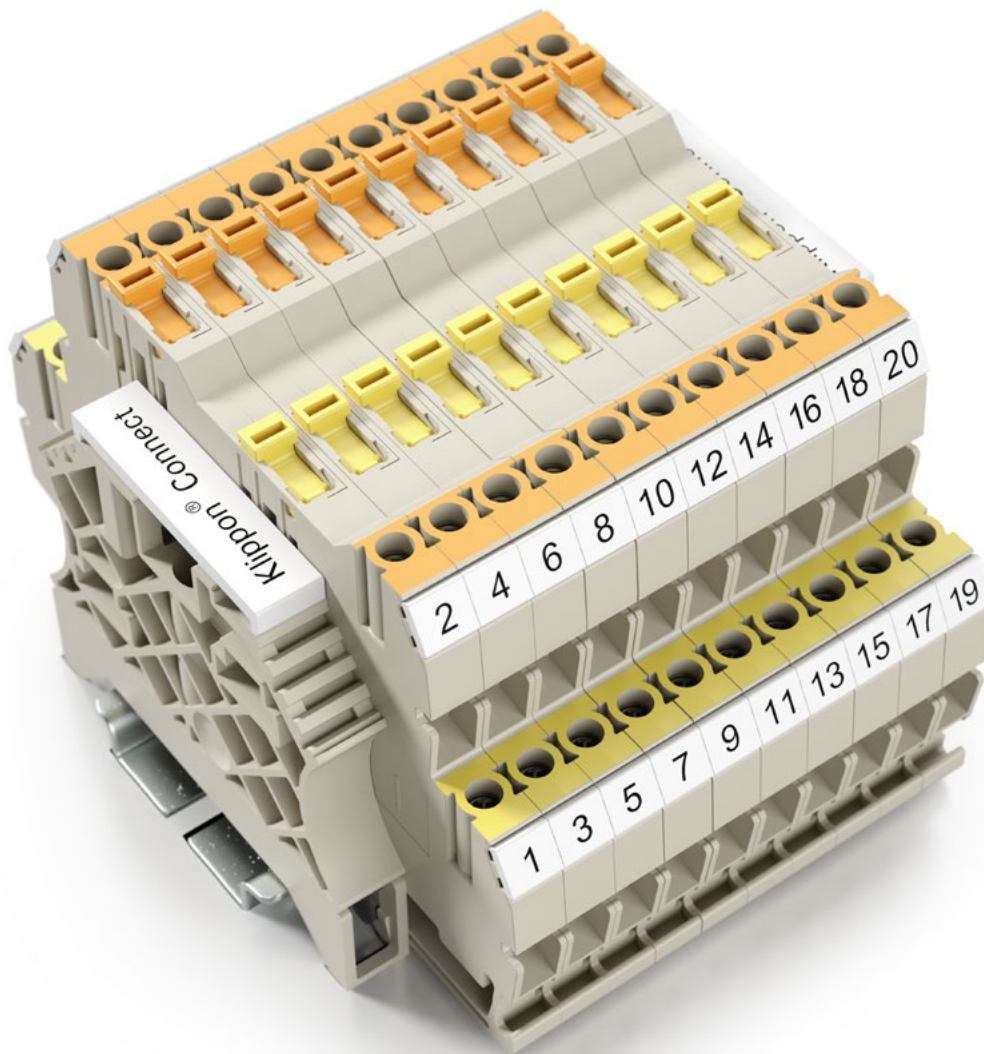

Time-saving in testing and revision

Easily accessible test facilities in front of and behind the clamping point allow the system to be tested quickly and safely. A 2.0 standard test adapter can also be mounted on the screw heads in wired condition.

Individual application solutions

The multifunctional disconnection area allows either a fuse holder or a component plug to be accommodated. Depending on the application, it can be used as a fuse terminal or as a terminal block with electronic components.

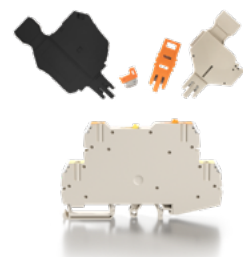
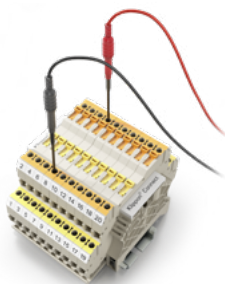

Screw connection with clamping yoke technology (W-Series)

Test-disconnect terminal blocks

WTR 2.5

2.5 mm²

With clamping screw

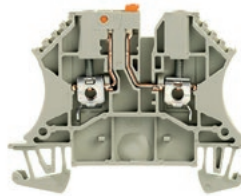

Width/Height/Depth	mm
max. current / max. cond. cross-section	A/mm ²
Max. clamping range	mm ²

5.1 x 60 x 48
24 / 4
0.05...4

Technical data

Rated data	
Rated voltage of feed-through terminal	V
Rated current	A
for wire cross-section	mm ²
Rated impulse withstand voltage / Pollution severity	
Gauge to IEC 60947-1 / UL 94 flammability rating	
Number of operating cycles	
Approvals	
Clamped conductors (H05V/H07V)	
Solid / Stranded	mm ²
Flexible / Flexible with ferrule	mm ²
Tightening torque / Clamping screw	Nm
Stripping length / Blade size	mm/-
Note	

IEC 60947-7-1

IEC	UL	CSA	EN 60079-7
500	600	300	
24	20	10	
2.5	AWG 30...12	AWG 26...12	
6 kV / 3			
A3 / V-0			



Rated connection	
0.5...4 / 1.5...4	
0.5...4	
0.4...0.8 / (M 2.5)	
10 / 0.6 x 3.5 mm	

Ordering data

Version	
	dark beige
	Blue
	without isolator, dark beige
Note	

Accessories

Plug-in cross-connection	
	2-pole
	10-pole
	2-pole
	10-pole
End plate / Partition plate	
	dark beige
	dark beige
End bracket	
	dark beige
Holder for cartridge fuse 5 x 20 mm	
	400 V AC/DC, without LED
	10 - 36 V AC/DC, red LED
	140 - 250 V AC/DC, red LED
Module connector (max. 250 V)	
	without fittings
	with wire jumper
	With 1N4007 diode
Screwdriver	
	Standard
Testing / Checking	
	Test adapter
	Test plug
Marking tags	

For detailed information on other accessories and application in the online catalogue

WTR 2.5 STB

2.5 mm²

With sockets

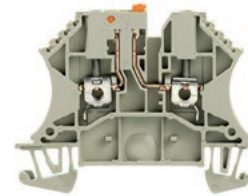

5.1 x 60 x 48
24 / 4
0.05...4

IEC 60947-7-1

IEC	UL	CSA	EN 60079-7
500	300	300	
24	20	10	
2.5	AWG 30...12	AWG 26...12	
6 kV / 3			
A3 / V-0			



Rated connection	
0.5...4 / 1.5...4	
0.5...4 / 0.5...2.5	
0.5...0.7 / (M 3)	
10 / 0.6 x 3.5 mm	

Type	Qty.	Order No.
WTR 2.5 STB2.3	100	1855620000
WTR 2.5 STB2.3 BL	100	8731660000
WTR 2.5/0.TNHE STB2.3	100	8731670000

Type	Qty.	Order No.
ZQV 2.5N/2	24 A 60	1527540000
ZQV 2.5N/10	24 A 20	1527690000
WAP 2.5-10	50	1050000000
WEW 35/2	50	1061200000
SIHA 3/G20	6.3 A 25	7921560000
SIHA 3/G20/LD 10-36V	25	7921570000
SIHA 3/G20/LD 140-250V	25	7921600000
BEST	50	1833100000
BEST/DRBR	22 A 50	1878570000
BEST/D	1 A 50	1878560000
SDS 0.6X3.5X100	1	2749340000
WTA 6 WTR2.5	6 A 25	1632380000
PS 2.3 RT	20 mA 20	0180400000
DEK 5/5 MC NE WS	1000	1609801044
WS 12/5 MC NE WS	720	1609860000
WS 8/5 MM WS	800	2007150000
DEK 5/5 MM WS	800	2007110000

For detailed information on other accessories and application in the online catalogue

WTR 2.5/ZZ

2.5 mm²

Twin connection

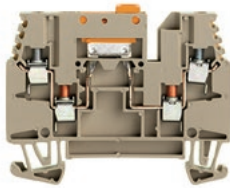

5.1 x 60 x 46.5
16 / 4
0.13...4



IEC	UL	CSA	EN 60079-7
400	300	300	
16	10	10	
2.5	AWG 26...12	AWG 26...12	
6 kV / 3			
A3 / V-0			

CE ENEC IEC

Rated connection

0.5...4 / 1.5...4
0.5...4 / 0.5...2.5
0.5...1 / (M 3)
7 / 0.6 x 3.5 mm

Type	Qty.	Order No.
WTR 2.5/ZZ	50	1039900000
WTR 2.5/ZZ BL	50	1039980000
WTR 2.5/ZZ 0.TNHE	50	1774670000

Type	Qty.	Order No.
ZQV 2.5N/2	24 A 60	1527540000
ZQV 2.5N/10	24 A 20	1527690000
WAP WTR2.5/ZZ	20	1074600000
WEW 35/2	50	1061200000
SIHA 1/G20	6.3 A 25	9537550000
SIHA 1/G20 10-36V	6.3 A 25	9537560000
SDS 0.6X3.5X100	1	2749340000
DEK 5/5 MC NE WS	1000	1609801044
WS 12/5 MC NE WS	720	1609860000
WS 8/5 MM WS	800	2007150000
DEK 5/5 MM WS	800	2007110000

WTR 4

4 mm²

With clamping screw

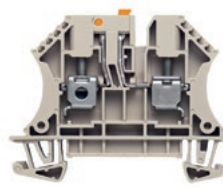

6.1 x 60 x 48
32 / 6
0.22...6

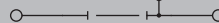

IEC	UL	CSA	EN 60079-7
500	300	300	
32	10	10	
4	AWG 22...10	AWG 22...10	
6 kV / 3			
A4 / V-0			

CE ENEC IEC

Rated connection

0.5...6 / 1.5...6
0.5...4 / 0.5...2.5
0.5...0.6 / (M 3)
13 / 0.6 x 3.5 mm

Type	Qty.	Order No.
WTR 4	50	7910180000
WTR 4 BL	50	7910190000
WTR 4/0.TNHE	50	2436380000

Type	Qty.	Order No.
ZQV 4N/2	32 A 60	1527930000
ZQV 4N/10	32 A 20	1528090000
WAP 2.5-10	50	1050000000
WAP 16+35 WTW 2.5-10	20	1050100000
WEW 35/2	50	1061200000
SIHA 3/G20	6.3 A 25	7921560000
SIHA 3/G20/LD 10-36V	25	7921570000
SIHA 3/G20/LD 140-250V	25	7921600000
BEST	50	1833100000
BEST/DRBR	22 A 50	1878570000
BEST/D	1 A 50	1878560000
SDS 0.6X3.5X100	1	2749340000
WS 12/5 MC NE WS	720	1609860000
WS 8/6 MM WS	600	2007160000
DEK 5/6 MM WS	600	2007120000

WTR 4 STB

4 mm²

With socket

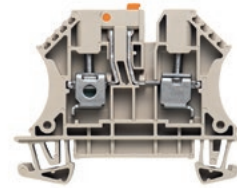

6.1 x 60 x 48
32 / 6
0.22...6



IEC	UL	CSA	EN 60079-7
500	300	300	
32	10	10	
4	AWG 22...10	AWG 22...10	
6 kV / 3			
A4 / V-0			

CE ENEC IEC

Rated connection

0.5...6 / 1.5...6
0.5...4 / 0.5...2.5
0.5...0.6 / (M 3)
13 / 0.6 x 3.5 mm

Type	Qty.	Order No.
WTR 4 STB	50	7910210000
WTR 4 STB BL	50	7910220000
WTR 4 STB/0.TNHE	50	2436390000

Type	Qty.	Order No.
ZQV 4N/2	32 A 60	1527930000
ZQV 4N/10	32 A 20	1528090000
WAP 2.5-10	50	1050000000
WAP 16+35 WTW 2.5-10	20	1050100000
WEW 35/2	50	1061200000
SIHA 3/G20	6.3 A 25	7921560000
SIHA 3/G20/LD 10-36V	25	7921570000
SIHA 3/G20/LD 140-250V	25	7921600000
BEST	50	1833100000
BEST/DRBR	22 A 50	1878570000
BEST/D	1 A 50	1878560000
SDS 0.6X3.5X100	1	2749340000
PS 2.3 RT	20 mA 20	0180400000
WS 12/5 MC NE WS	720	1609860000
WS 8/6 MM WS	600	2007160000
DEK 5/6 MM WS	600	2007120000

WTR 4/ZR

4 mm²

Supplementary connection, right, with clamping screw

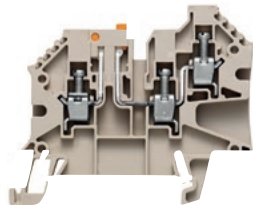

6.1 x 63.5 x 53
27 / 6
0.05...6

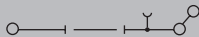

IEC	UL	CSA	EN 60079-7
500	600	600	
27	25	25	
4	AWG 30...10	AWG 30...10	
		6 kV / 3	
		A4 / V-0	

CE

Rated connection

0.5...6 / 1.5...6
0.5...4 / 0.5...2.5
0.5...1 / (M 3)
10 / 0.6 x 3.5 mm

Type	Qty.	Order No.
WTR 4/ZR	50	1905080000
WTR 4/ZR/O.TNHE	50	2436400000

Type	Qty.	Order No.
ZQV 4N/2	32 A 60	1527930000
ZQV 4N/10	32 A 20	1528090000
WAP WDU/WTR4/ZR	50	1905070000
WEW 35/2	50	1061200000
SIHA 3/G20	6.3 A 25	7921560000
SIHA 3/G20/LD 10-36V	25	7921570000
SIHA 3/G20/LD 140-250V	25	7921600000
BEST	50	1833100000
BEST/DRBR	22 A 50	1878570000
BEST/D	1 A 50	1878560000
TNST	20 A 50	1833090000
SDS 0.6X3.5X100	1	2749340000
DEK 5/5 MC NE WS	1000	1609801044
WS 8/6 MM WS	600	2007160000
DEK 5/6 MM WS	600	2007120000
WS 12/5 MC NE WS	720	1609860000

WTR 4/ZR STB

4 mm²

Supplementary connection with socket

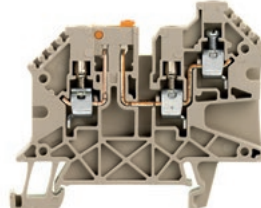

6.1 x 63.5 x 53
27 / 6
0.05...6

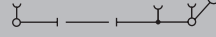

IEC	UL	CSA	EN 60079-7
500	600	600	
27	25	25	
4	AWG 30...10	AWG 30...10	
		6 kV / 3	
		A4 / V-0	

CE

Rated connection

0.5...6 / 1.5...6
0.5...4 / 0.5...2.5
0.5...1 / (M 3)
10 / 0.6 x 3.5 mm

Type	Qty.	Order No.
WTR 4/ZR STB	50	1905110000
WTR 4/ZR STB/O.TNHE	50	2436410000

Type	Qty.	Order No.
ZQV 4N/2	32 A 60	1527930000
ZQV 4N/10	32 A 20	1528090000
WAP WDU/WTR4/ZR	50	1905070000
WEW 35/2	50	1061200000
SIHA 3/G20	6.3 A 25	7921560000
SIHA 3/G20/LD 10-36V	25	7921570000
SIHA 3/G20/LD 140-250V	25	7921600000
BEST	50	1833100000
BEST/DRBR	22 A 50	1878570000
BEST/D	1 A 50	1878560000
TNST	20 A 50	1833090000
SDS 0.6X3.5X100	1	2749340000
DEK 5/5 MC NE WS	1000	1609801044
WS 8/6 MM WS	600	2007160000
DEK 5/6 MM WS	600	2007120000
WS 12/5 MC NE WS	720	1609860000
PS 2.3 RT	20 mA 20	0180400000

WTR 4 SL

4 mm²

With clamping screw

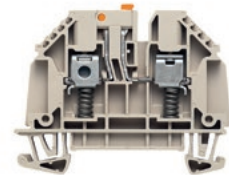

6.1 x 61.5 x 46.5
32 / 6
0.22...6



IEC 60947-7-1

IEC	UL	CSA	EN 60079-7
630	300	300	
32	22	10	
4	AWG 22...10	AWG 22...10	
		6 kV / 2	
		A4 / V-0	

CE

Rated connection

0.5...6 / 1.5...6
0.5...4
0.5...0.6 / (M 3)
13 / 0.6 x 3.5 mm

Type	Qty.	Order No.
WTR 4 SL	50	7910270000
WTR 4 SL BL	50	7910280000

Type	Qty.	Order No.
ZQV 4N/2	32 A 60	1527930000
ZQV 4N/10	32 A 20	1528090000
WAP 2.5-10	50	1050000000
WAP 16+35 WTW 2.5-10	20	1050100000
WEW 35/2	50	1061200000
SIHA 3/G20	6.3 A 25	7921560000
SIHA 3/G20/LD 10-36V	25	7921570000
SIHA 3/G20/LD 140-250V	25	7921600000
BEST	50	1833100000
BEST/DRBR	22 A 50	1878570000
BEST/D	1 A 50	1878560000
TNST	20 A 50	1833090000
SDS 0.6X3.5X100	1	2749340000
HBT 1,5 - 3,0 RT	100	1312440000
HBT 2,5 - 3,0 BL	100	1312450000
DEK 5/6 MC NE WS	1000	1609820000
WS 12/6 MC NE WS	600	1609900000
DEK 5/6 MM WS	600	2007120000



Screw connection with clamping yoke technology (W-Series)

Test-disconnect terminal blocks

Universal range

A

WTR 4 SL STB

4 mm²

With socket

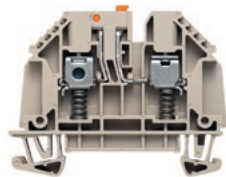

WTR 4 SL/EN

4 mm²

with clamping screw

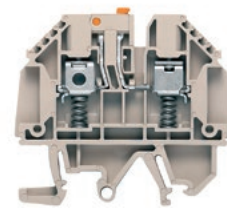

Width/Height/Depth	mm
max. current / max. cond. cross-section	A/mm ²
Max. clamping range	mm ²

6.1 x 61.5 x 46.5
32 / 6
0.22...6

6.1 x 61.5 x 51
32 / 6
0.22...6

Technical data

Rated data	
Rated voltage of feed-through terminal	V
Rated current	A
for wire cross-section	mm ²
Rated impulse withstand voltage / Pollution severity	
Gauge to IEC 60947-1 / UL 94 flammability rating	
Number of operating cycles	
Approvals	
Clamped conductors (H05V/H07V)	
Solid / Stranded	mm ²
Flexible / Flexible with ferrule	mm ²
Tightening torque / Clamping screw	Nm
Stripping length / Blade size	mm/-
Note	

IEC 60947-7-1

IEC	UL	CSA	EN 60079-7
500	300	300	
32	22	10	
4	AWG 22...10	AWG 22...10	
6 kV / 3			
A4 / V-0			

CE

Rated connection	
0.5...6 / 1.5...6	
0.5...4	
0.5...0.6 / (M 3)	
13 / 0.6 x 3.5 mm	

IEC 60947-7-1

IEC	UL	CSA	EN 60079-7
630	300	300	
32	22	10	
4	AWG 22...10	AWG 22...10	
6 kV / 2			
A4 / V-0			

CE

Rated connection	
0.5...6 / 1.5...6	
0.5...4	
0.5...1 / (M 3)	
13 / 0.6 x 3.5 mm	

Ordering data

Version	
	dark beige
	Blue
Note	

Type	Qty.	Order No.
WTR 4 STB SL	50	7910300000
WTR 4 STB SL BL	50	7910310000

Type	Qty.	Order No.
WTR4 SL/EN	50	7910360000
WTR4 SL/EN BL	50	7910370000

Accessories

Plug-in cross-connection	2-pole
	10-pole
End plate / Partition plate	dark beige
	dark beige
End bracket	dark beige
Hak. Cable lugs	dark beige
Testing / Checking	Test plug
Marking tags	

Type	Qty.	Order No.
ZQV 4N/2	32 A 60	1527930000
ZQV 4N/10	32 A 20	1528090000
WAP 2.5-10	50	1050000000
WAP 16+35 WTW 2.5-10	20	1050100000
WEW 35/2	50	1061200000
HBT 1.5 - 3,0 RT	100	1312440000
HBT 2,5 - 3,0 BL	100	1312450000
PS 2.3 RT	20 mA 20	0180400000
DEK 5/6 MC NE WS	1000	1609820000
WS 12/6 MC NE WS	600	1609900000
DEK 5/6 MM WS	600	2007120000

Type	Qty.	Order No.
ZQV 4N/2	32 A 60	1527930000
ZQV 4N/10	32 A 20	1528090000
WAP 2.5-10	50	1050000000
WAP 16+35 WTW 2.5-10	20	1050100000
WEW 35/2	50	1061200000
HBT 1,5 - 3,0 RT	100	1312440000
HBT 2,5 - 3,0 BL	100	1312450000
DEK 5/6 MC NE WS	1000	1609820000
WS 12/6 MC NE WS	600	1609900000
DEK 5/6 MM WS	600	2007120000

For detailed information on other accessories and application in the online catalogue

WTR 4 STB SL/EN

4 mm²

With socket

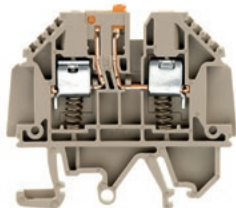

6.1 x 61.5 x 51
32 / 6
0.22...6



IEC 60947-7-1

IEC	UL	CSA	EN 60079-7
500	300	300	
32	22	10	
4	AWG 22...10	AWG 22...10	
6 kV / 3			
A4 / V-0			

CE

Rated connection

0.5...6 / 1.5...6

0.5...4

0.5...1 / (M 3)

13 / 0.6 x 3.5 mm

Type	Qty.	Order No.
WTR4 SL/EN STB	50	7910390000

Type	Qty.	Order No.
ZQV 4N/2	32 A 60	1527930000
ZQV 4N/10	32 A 20	1528090000
WAP 2.5-10	50	1050000000
WAP 16+35 WTW 2.5-10	20	1050100000
WEW 35/2	50	1061200000
HBT 1,5 - 3,0 RT	100	1312440000
HBT 2,5 - 3,0 BL	100	1312450000
DEK 5/6 MC NE WS	1000	1609820000
WS 12/6 MC NE WS	600	1609900000
DEK 5/6 MM WS	600	2007120000



Screw connection with clamping yoke technology (W-Series)

Test-disconnect terminal blocks

WDT 1.5/1

1.5 mm²

Disconnection lower level

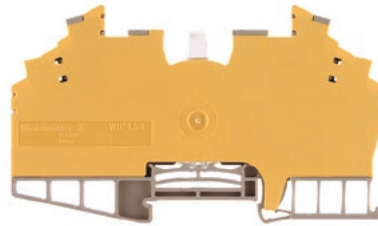

WDT 1.5/2

1.5 mm²

Disconnection both levels

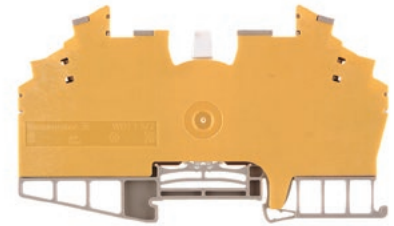

Width/Height/Depth	mm
max. current / max. cond. cross-section	A/mm ²
Max. clamping range	mm ²

6.4 x 112 x 66	
10 / 2.5	
0.13...2.5	

6.4 x 112 x 66	
10 / 2.5	
0.13...2.5	

Technical data

Rated data	
Rated voltage of feed-through terminal	V
Rated current	A
for wire cross-section	mm ²
Rated impulse withstand voltage / Pollution severity	
Gauge to IEC 60947-1 / UL 94 flammability rating	
Number of operating cycles	
Approvals	
Clamped conductors (H05V/H07V)	
Solid / Stranded	mm ²
Flexible / Flexible with ferrule	mm ²
Tightening torque / Clamping screw	Nm
Stripping length / Blade size	mm/-

IEC 60947-7-1

IEC	UL	CSA	EN 60079-7
250	300	300	
10	10	10	
1.5	AWG 26...14	AWG 26...14	
4 kV / 3			
A2 / V-0			

CE

Rated connection	
0.5...2.5 / 1.5...2.5	
0.5...1.5 / 0.5...1.5	
0.4...0.6 / (M 2.5)	
10 / 0.6 x 3.5 mm	

IEC 60947-7-1

IEC	UL	CSA	EN 60079-7
250	300	300	
10	10	10	
1.5	AWG 26...14	AWG 26...14	
4 kV / 3			
A2 / V-0			

CE

Rated connection	
0.5...2.5 / 1.5...2.5	
0.5...1.5 / 0.5...1.5	
0.4...0.6 / (M 2.5)	
10 / 0.6 x 3.5 mm	

Note

Ordering data

Version	
	dark beige
Note	

Type	Qty.	Order No.
WDT 1.5/1 DB/GE	25	1015800000

Type	Qty.	Order No.
WDT 1.5/2 DB/GE	25	1015900000

Accessories

End bracket	
	dark beige
Screwdriver	
	Standard
Locking lever	
Marking tags	

Type	Qty.	Order No.
WEW 35/2	50	1061200000
SDS 0.6X3.5X100	1	2749340000
RAHE LN WDT1.5	10	1865410000
DEK 5/6.5 MC NE WS	900	1609840000
WS 8/5 MC NE WS	720	1640740000

Type	Qty.	Order No.
WEW 35/2	50	1061200000
SDS 0.6X3.5X100	1	2749340000
RAHE LN WDT1.5	10	1865410000
DEK 5/6.5 MC NE WS	900	1609840000
WS 8/5 MC NE WS	720	1640740000

For detailed information on other accessories and application in the online catalogue

WDT 1.5/3

1.5 mm²

Disconnection lower level or both levels

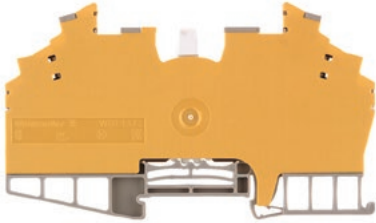

6.4 x 112 x 66
10 / 2.5
0.13...2.5



IEC 60947-7-1

IEC	UL	CSA	EN 60079-7
250	300	300	
10	10	10	
1.5	AWG 26...14	AWG 26...14	
4 kV / 3			
A2 / V-0			

CE

Rated connection

0.5...2.5 / 1.5...2.5

0.5...1.5 / 0.5...1.5

0.4...0.6 / (M 2.5)

10 / 0.6 x 3.5 mm

Type	Qty.	Order No.
WDT 1.5/3 DB/GE	25	1016000000

Type	Qty.	Order No.
WEW 35/2	50	1061200000
SDS 0.6X3.5X100	1	2749340000
RAHE LN WDT1.5	10	1865410000
DEK 5/6.5 MC NE WS	900	1609840000
WS 8/5 MC NE WS	720	1640740000



Screw connection with clamping yoke technology (W-Series)

Test-disconnect terminal blocks

WDTR 2.5

2.5 mm²

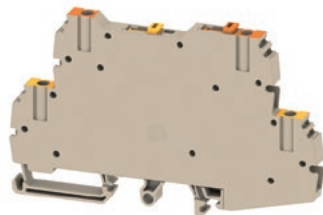

WDTR 2.5/WE

2.5 mm²

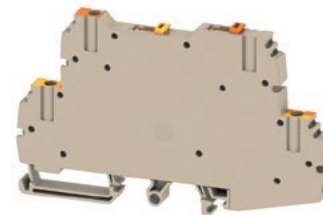

Width/Height/Depth	mm
max. current / max. cond. cross-section	A/mm ²
Max. clamping range	mm ²

6.15 x 94 x 65	
17 / 4	
0.05...4	

6.15 x 94 x 65	
17 / 4	
0.05...4	

Technical data

Rated data	
Rated voltage of feed-through terminal	V
Rated current	A
for wire cross-section	mm ²
Rated impulse withstand voltage / Pollution severity	
Gauge to IEC 60947-1 / UL 94 flammability rating	
Number of operating cycles	
Approvals	
Clamped conductors (H05V/H07V)	
Solid / Stranded	mm ²
Flexible / Flexible with ferrule	mm ²
Tightening torque / Clamping screw	Nm
Stripping length / Blade size	mm/-
Note	

IEC 60947-7-1			
IEC	UL	CSA	EN 60079-7
500	150		
17	20		
2.5	AWG 30...12		
6 kV / 3			
A3 / V-0			
CE			
Rated connection			
0.5...4 / 1.5...4			
0.5...2.5 / 0.5...2.5			
0.5...0.6 /			
8 / 0.6 x 3.5 mm			
Note			

IEC 60947-7-1			
IEC	UL	CSA	EN 60079-7
500	300		
17	17		
2.5	AWG 26...12		
6 kV / 3			
A3 / V-0			
CE			
Rated connection			
0.5...4 / 1.5...4			
0.5...2.5 / 0.5...2.5			
0.5...0.6 /			
8 / 0.6 x 3.5 mm			
Note			

Ordering data

Version	
	dark beige
	without STB
	Blue
	Blue, without STB
Note	

Type	Qty.	Order No.
WDTR 2.5	25	2456000000
WDTR 2.5 O.STB	25	2456030000
WDTR 2.5 BL	25	2456010000
WDTR 2.5 BL O.STB	25	2910900000
Note		

Type	Qty.	Order No.
WDTR 2.5/WE	25	2456020000
Note		

Accessories

Cross-connector	black
	red
	blue
End bracket	dark beige
	black
Screwdriver	Standard
Holder for cartridge fuse 5 x 20 mm	400 V AC/DC, without LED
	10 - 36 V AC/DC, red LED
	35 - 70 V AC/DC, red LED
	60 - 150 V AC/DC, red LED
	140 - 250 V AC/DC, red LED
Disconnect plug	removable, as replacement for release lever
	orange
Module connector (max. 250 V)	without fittings
	With 1N4007 diode
	with wire jumper
Marking tags	
For detailed information on other accessories and application in the online catalogue	

Type	Qty.	Order No.
VQB 1.5/50 SW	17.5 A 5	1635120000
VQB 1.5/50 RT	17.5 A 5	1633290000
VQB 1.5/50 BL	17.5 A 5	1633280000
WEW 35/2	50	1061200000
WEW 35/2 SW	50	1061210000
SDIS SLIM 0.6X3.5X100	1	2749610000
SIHA 3/G20	6.3 A 25	7921560000
SIHA 3/G20/LD 10-36V	25	7921570000
SIHA 3/G20/LD 35-70V	25	7921580000
SIHA 3/G20/LD 60-150V	25	7921590000
SIHA 3/G20/LD 140-250V	25	7921600000
TNST	20 A 50	1833090000
TNST OR	20 A 50	2463540000
WSD 2.5/SCAN WTR2.5	25	1058760000
BEST	50	1833100000
BEST/D	50	1878560000
BEST/DRBR	50	1878570000
WS 8/5 MC NE WS	720	1640740000
DEK 5/6 MC NE WS	1000	1609820000
Note		

Type	Qty.	Order No.
VQB 1.5/50 SW	17.5 A 5	1635120000
VQB 1.5/50 RT	17.5 A 5	1633290000
VQB 1.5/50 BL	17.5 A 5	1633280000
WEW 35/2	50	1061200000
WEW 35/2 SW	50	1061210000
SDIS SLIM 0.6X3.5X100	1	2749610000
SIHA 3/G20	6.3 A 25	7921560000
SIHA 3/G20/LD 10-36V	25	7921570000
SIHA 3/G20/LD 35-70V	25	7921580000
SIHA 3/G20/LD 60-150V	25	7921590000
SIHA 3/G20/LD 140-250V	25	7921600000
TNST	20 A 50	1833090000
TNST OR	20 A 50	2463540000
WSD 2.5/SCAN WTR2.5	25	1058760000
BEST	50	1833100000
BEST/D	50	1878560000
BEST/DRBR	50	1878570000
WS 8/5 MC NE WS	720	1640740000
DEK 5/6 MC NE WS	1000	1609820000
Note		



Screw connection with clamping yoke technology (W-Series)

Test-disconnect terminal blocks

WDK 2.5/TR-DU

2.5 mm²

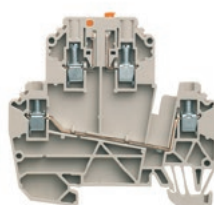

WDK 2.5/TR-DU/STB

2.5 mm²

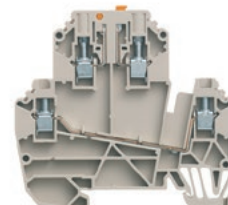

Width/Height/Depth	mm
max. current / max. cond. cross-section	A/mm ²
Max. clamping range	mm ²

5.1 x 72.5 x 67.5	
24 / 4	
0.5...4	

5.1 x 72.5 x 67.5	
24 / 4	
0.5...4	

Technical data

Rated data	
Rated voltage of feed-through terminal	V
Rated current	A
for wire cross-section	mm ²
Rated impulse withstand voltage / Pollution severity	
Gauge to IEC 60947-1 / UL 94 flammability rating	
Number of operating cycles	
Approvals	

Clamped conductors (H05V/H07V)	
Solid / Stranded	mm ²
Flexible / Flexible with ferrule	mm ²
Tightening torque / Clamping screw	Nm
Stripping length / Blade size	mm/-

Note

IEC	UL	CSA	EN 60079-7
500		300	
24		20	
2.5		AWG 30...12	
		8 kV / 3	
		A2 / V-0	

Rated connection	
0.5...4 / 1.5...4	
0.5...4 / 0.5...2.5	
0.5...0.6 / (M 3)	
8 / 0.6 x 3.5 mm	

IEC	UL	CSA	EN 60079-7
500		300	
24		20	
2.5		AWG 30...12	
		8 kV / 3	
		A2 / V-0	

Rated connection	
0.5...4 / 1.5...4	
0.5...4 / 0.5...2.5	
0.5...0.6 / (M 3)	
8 / 0.6 x 3.5 mm	

Ordering data

Version	
	dark beige
	without isolator, dark beige

Note

Type	Qty.	Order No.
WDK 2.5/TR-DU	50	1247290000
WDK 2.5/TR-DU/0 TNHE	50	1833600000

Type	Qty.	Order No.
WDK 2.5/TR-DU STB	50	1247310000

Accessories

Screwable cross-connection	
	2-pole
	10-pole

End plate / Partition plate

End bracket

Holder for cartridge fuse 5 x 20 mm

Type	Qty.	Order No.
WQV 2.5/2	32 A 50	1053660000
WQV 2.5/10	32 A 20	1054460000
WAP WDK 2.5N/TR-DU	50	1839850000
WEW 35/1	50	1059000000
SIHA 3/G20	6.3 A 25	7921560000
SIHA 3/G20/LD 10-36V	25	7921570000
SIHA 3/G20/LD 140-250V	25	7921600000

Module connector (max. 250 V)	
	without fittings
	With 1N4007 diode
	with wire jumper

Disconnect plug

Screwdriver

Testing / Checking

Marking tags

Type	Qty.	Order No.
WQV 2.5/2	32 A 50	1053660000
WQV 2.5/10	32 A 20	1054460000
WAP WDK 2.5N/TR-DU	50	1839850000
WEW 35/1	50	1059000000
SIHA 3/G20	6.3 A 25	7921560000
SIHA 3/G20/LD 10-36V	25	7921570000
SIHA 3/G20/LD 140-250V	25	7921600000

WAP WDK 2.5N/TR-DU

WEW 35/1

SIHA 3/G20

SIHA 3/G20/LD 10-36V

SIHA 3/G20/LD 140-250V

BEST

BEST/D

BEST/DRBR

TNST

SDS 0.6X3.5X100

PS 2.3 RT

DEK 5/5 MC NE WS

WS 8/5 MC NE WS

DEK 5/5 MM WS

Type	Qty.	Order No.
WQV 2.5/2	32 A 50	1053660000
WQV 2.5/10	32 A 20	1054460000
WAP WDK 2.5N/TR-DU	50	1839850000
WEW 35/1	50	1059000000
SIHA 3/G20	6.3 A 25	7921560000
SIHA 3/G20/LD 10-36V	25	7921570000
SIHA 3/G20/LD 140-250V	25	7921600000

WAP WDK 2.5N/TR-DU

WEW 35/1

SIHA 3/G20

SIHA 3/G20/LD 10-36V

SIHA 3/G20/LD 140-250V

BEST

BEST/D

BEST/DRBR

TNST

SDS 0.6X3.5X100

PS 2.3 RT

DEK 5/5 MC NE WS

WS 8/5 MC NE WS

DEK 5/5 MM WS

For detailed information on other accessories and application in the online catalogue

WDK 2.5/TR-DU-PE

2.5 mm²

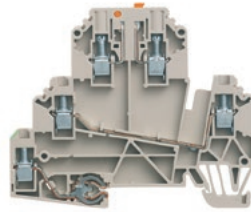

5.1 x 80.5 x 67.5
24 / 4
0.5...4

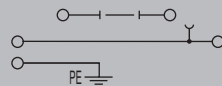

WDK 2.5/TR-DU-PE/STB

2.5 mm²

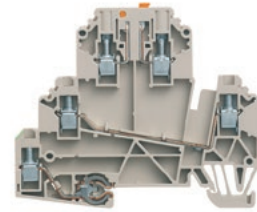

5.1 x 80.5 x 67.5
24 / 4
0.5...4

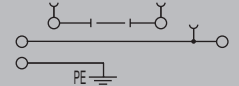

Width/Height/Depth mm
max. current / max. cond. cross-section A/mm²
Max. clamping range mm²

Technical data

Rated data	
Rated voltage of feed-through terminal	V
Rated current	A
for wire cross-section	mm ²
Rated impulse withstand voltage / Pollution severity	
Gauge to IEC 60947-1 / UL 94 flammability rating	
Number of operating cycles	
Approvals	
Clamped conductors (H05V/H07V)	
Solid / Stranded	mm ²
Flexible / Flexible with ferrule	mm ²
Tightening torque / Clamping screw	Nm
Stripping length / Blade size	mm/-
Note	

IEC	UL	CSA	EN 60079-7
500			
24			
2.5			
	8 kV / 3		
	A2 / V-0		
C E EMC			
Rated connection			
0.5...4 / 1.5...4			
0.5...4 / 0.5...2.5			
0.5...0.6 / (M 3)			
8 / 0.6 x 3.5 mm			
Note			

IEC	UL	CSA	EN 60079-7
500			
24			
2.5			
	8 kV / 3		
	A2 / V-0		
C E EMC			
Rated connection			
0.5...4 / 1.5...4			
0.5...4 / 0.5...2.5			
0.5...0.6 / (M 3)			
8 / 0.6 x 3.5 mm			
Note			

Ordering data

Version	
	dark beige
	without isolator, dark beige
Note	

Type	Qty.	Order No.
WDK 2.5/TR-DU-PE	50	1247420000
WDK 2.5/TR-DU-PE/O TNHE	50	1833640000
Note		

Type	Qty.	Order No.
WDK 2.5/TR-DU-PE STB	50	1247430000
Note		

Accessories

Screwable cross-connection	
	2-pole
	10-pole
End plate / Partition plate	dark beige
End bracket	dark beige, screwable
Holder for cartridge fuse 5 x 20 mm	400 V AC/DC, without LED
	10 - 36 V AC/DC, red LED
	140 - 250 V AC/DC, red LED
Module connector (max. 250 V)	without fittings
	With 1N4007 diode
	with wire jumper
Disconnect plug	removable, as replacement for release lever
Screwdriver	Standard
Testing / Checking	Test plug
Marking tags	

Type	Qty.	Order No.
WQV 2.5/2	32 A 50	1053660000
WQV 2.5/10	32 A 20	1054460000
WAP WDK 2.5N/TR-DU	50	1839850000
WEW 35/1	50	1059000000
SIHA 3/G20	6.3 A 25	7921560000
SIHA 3/G20/LD 10-36V	25	7921570000
SIHA 3/G20/LD 140-250V	25	7921600000
BEST	50	1833100000
BEST/D	1 A 50	1878560000
BEST/DRBR	22 A 50	1878570000
TNST	20 A 50	1833090000
SDS 0.6X3.5X100	1	2749340000
DEK 5/5 MC NE WS	1000	1609801044
WS 8/5 MC NE WS	720	1640740000
DEK 5/5 MM WS	800	2007110000
Note		

Type	Qty.	Order No.
WQV 2.5/2	32 A 50	1053660000
WQV 2.5/10	32 A 20	1054460000
WAP WDK 2.5N/TR-DU	50	1839850000
WEW 35/1	50	1059000000
SIHA 3/G20	6.3 A 25	7921560000
SIHA 3/G20/LD 10-36V	25	7921570000
SIHA 3/G20/LD 140-250V	25	7921600000
BEST	50	1833100000
BEST/D	1 A 50	1878560000
BEST/DRBR	22 A 50	1878570000
TNST	20 A 50	1833090000
SDS 0.6X3.5X100	1	2749340000
PS 2.3 RT	20 mA 20	0180400000
DEK 5/5 MC NE WS	1000	1609801044
WS 8/5 MC NE WS	720	1640740000
DEK 5/5 MM WS	800	2007110000
Note		

For detailed information on other accessories and application in the online catalogue



Screw connection with clamping yoke technology (W-Series)

Pluggable terminal blocks

Universal range

A

WT 2.5

2.5 mm²

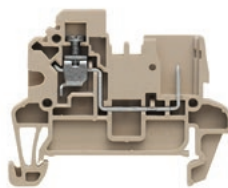

WDT 2.5 BT

2.5 mm²

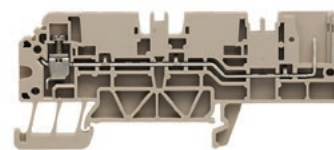

Width/Height/Depth	mm
max. current / max. cond. cross-section	A/mm ²
Max. clamping range	mm ²

5.1 x 50.5 x 40	
27 / 4	
0.13...4	

5.1 x 85.5 x 36	
27 / 4	
0.13...4	

Technical data

Rated data	
Rated voltage of feed-through terminal	V
Rated current	A
for wire cross-section	mm ²
Rated impulse withstand voltage / Pollution severity	
Gauge to IEC 60947-1 / UL 94 flammability rating	
Approvals	
Clamped conductors (H05V/H07V)	
Solid / Stranded	mm ²
Flexible / Flexible with ferrule	mm ²
Tightening torque / Clamping screw	Nm
Stripping length / Blade size	mm/-

IEC 60947-7-1, IEC 61984

IEC	UL	CSA	EN 60079-7
500	300	300	
24	20	20	
2.5	AWG 26...12	AWG 16...12	
6 kV / 3			
A4 / V-0			

CE

Rated connection	
0.5...4 / 1.5...4	
0.5...4 / 0.5...2.5	
0.4...0.6 / (M 2.5)	
7 / 0.6 x 3.5 mm	

IEC 60947-7-1, IEC 61984

IEC	UL	CSA	EN 60079-7
500	300	300	
24	20	20	
2.5	AWG 26...12	AWG 26...12	
6 kV / 3			
A4 / V-0			

CE

Rated connection	
0.5...4 / 1.5...4	
0.5...4 / 0.5...2.5	
0.4...0.6 / (M 2.5)	
7 / 0.6 x 3.5 mm	

Note

Ordering data

Type	Qty.	Order No.
WT 2.5	50	1305330000

Plug-in connector

Type	Qty.	Order No.
WP 2.5/1AN/1	50	1305270000
WP 2.5/1AN/10	50	1305280000

Note

Type	Qty.	Order No.
WT 2.5	50	1305330000

Plug-in connector

Type	Qty.	Order No.
WP 2.5/1AN/1	50	1305270000
WP 2.5/1AN/10	50	1305280000

Type	Qty.	Order No.
WDT 2.5 BT	50	1305310000

Plug-in connector

Type	Qty.	Order No.
WP 2.5/1AN/1	50	1305270000
WP 2.5/1AN/10	50	1305280000

Accessories

Plug-in cross-connection	
	2-pole
	10-pole
End plate	
Cover	
End bracket	
	dark beige
Strain relief	
Coding	
Interlock	
Screwdriver	
	Standard
Plug	
	dark beige
Marking tags	
Vertical jumpers	
	1-pole

Type	Qty.	Order No.
ZQV 2.5N/2	24 A 60	1527540000
ZQV 2.5N/10	24 A 20	1527690000
WAP WDT 2.5 AT	50	1305250000
WEW 35/2	50	1061200000
APGSR 2.5/4	25	2457580000
APGCE	50	1514490000
APGLE 2.5/4	25	2457570000
SDS 0.6X3.5X100	1	2749340000
DEK 5/5 MC NE WS	1000	1609801044
WS 10/5 MC NE WS	720	1635000000
DEK 5/5 MM WS	800	2007110000

Type	Qty.	Order No.
ZQV 2.5N/2	24 A 60	1527540000
ZQV 2.5N/10	24 A 20	1527690000
WAP WDT 2.5 BT	50	1305240000
AH WDT 2.5 BT	50	1305230000
WEW 35/2	50	1061200000
APGSR 2.5/4	25	2457580000
APGCE	50	1514490000
APGLE 2.5/4	25	2457570000
SDS 0.6X3.5X100	1	2749340000
WDT 2.5 AT	24 A 50	1305320000
DEK 5/5 MC NE WS	1000	1609801044
WS 10/5 MC NE WS	720	1635000000
DEK 5/5 MM WS	800	2007110000

For detailed information on other accessories and application in the online catalogue

WDT 2.5 AT

2.5 mm²

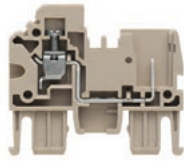

5.1 x 42 x 24.6
27 / 4
0.13...4



In accordance with IEC 60947-7-1

IEC	UL	CSA	EN 60079-7
500	300	300	
24	20	20	
2.5	AWG 26...12	AWG 26...12	
6 kV / 3			
A4 / V-0			

CE e-NSI ENEC

Rated connection

0.5...4 / 1.5...4
0.5...4 / 0.5...2.5
0.4...0.6 / (M 2.5)
7 / 0.6 x 3.5 mm

WDT 2.5/2

2.5 mm²

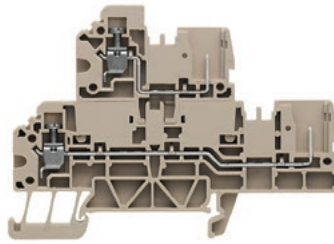

5.1 x 85.5 x 60.5
27 / 4
0.13...4

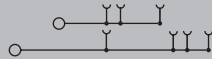

IEC 60947-7-1, IEC 61984

IEC	UL	CSA	EN 60079-7
500	300	300	
24	20	20	
2.5	AWG 26...12	AWG 26...12	
6 kV / 3			
A4 / V-0			

CE e-NSI ENEC

Rated connection

0.5...4 / 1.5...4
0.5...4 / 0.5...2.5
0.4...0.6 / (M 2.5)
7 / 0.6 x 3.5 mm

WDT 2.5/2 V

2.5 mm²

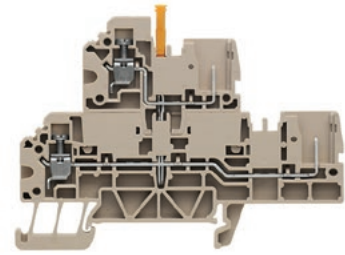

5.1 x 85.5 x 60.5
27 / 4
0.13...4

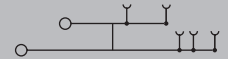

IEC 60947-7-1, IEC 61984

IEC	UL	CSA	EN 60079-7
400	300	300	
24	20.1	10	
2.5	AWG 26...12	AWG 26...12	
6 kV / 3			
A4 / V-0			

CE e-NSI ENEC

Rated connection

0.5...4 / 1.5...4
0.5...4 / 0.5...2.5
0.4...0.6 / (M 2.5)
7 / 0.6 x 3.5 mm

Type	Qty.	Order No.
WDT 2.5 AT	50	1305320000
WP 2.5/1AN/1	50	1305270000
WP 2.5/1AN/10	50	1305280000

Type	Qty.	Order No.
WDT 2.5/2	50	1305290000
WP 2.5/1AN/1	50	1305270000
WP 2.5/1AN/10	50	1305280000

Type	Qty.	Order No.
WDT 2.5/2 V	50	1305300000
WP 2.5/1AN/1	50	1305270000
WP 2.5/1AN/10	50	1305280000

Type	Qty.	Order No.
ZQV 2.5N/2	24 A 60	1527540000
ZQV 2.5N/10	24 A 20	1527690000
WAP WDT 2.5 AT	50	1305250000
APGSR 2.5/4	25	2457580000
APGCE	50	1514490000
APGLE 2.5/4	25	2457570000
SDS 0.6X3.5X100	1	2749340000
DEK 5/5 MC NE WS	1000	1609801044
WS 10/5 MC NE WS	720	1635000000
DEK 5/5 MM WS	800	2007110000

Type	Qty.	Order No.
ZQV 2.5N/2	24 A 60	1527540000
ZQV 2.5N/10	24 A 20	1527690000
WAP WDT 2.5/2	50	1305260000
WEW 35/2	50	1061200000
APGSR 2.5/4	25	2457580000
APGCE	50	1514490000
APGLE 2.5/4	25	2457570000
SDS 0.6X3.5X100	1	2749340000
DEK 5/5 MC NE WS	1000	1609801044
WS 10/5 MC NE WS	720	1635000000
DEK 5/5 MM WS	800	2007110000
ZVQ 2.5/1.5	24 A 50	1720700000

Type	Qty.	Order No.
ZQV 2.5N/2	24 A 60	1527540000
ZQV 2.5N/10	24 A 20	1527690000
WAP WDT 2.5/2	50	1305260000
WEW 35/2	50	1061200000
APGSR 2.5/4	25	2457580000
APGCE	50	1514490000
APGLE 2.5/4	25	2457570000
SDS 0.6X3.5X100	1	2749340000
DEK 5/5 MC NE WS	1000	1609801044
WS 10/5 MC NE WS	720	1635000000
DEK 5/5 MM WS	800	2007110000



Screw connection with clamping yoke technology (W-Series)

Pluggable terminal blocks

WT4 4 AN/2

4 mm²

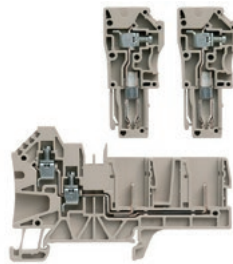

Width/Height/Depth	mm
max. current / max. cond. cross-section	A/mm ²
Max. clamping range	mm ²

6.1 x 84.3 x 50

32 / 6

0.5...6

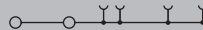

Technical data

Rated data	
Rated voltage	V
Rated current	A
for wire cross-section	mm ²
Rated impulse withstand voltage / Pollution severity	
Gauge to IEC 60947-1 / UL 94 flammability rating	
Approvals	
Clamped conductors (H05V/H07V)	
Solid / Stranded	mm ²
Flexible / Flexible with ferrule	mm ²
Tightening torque / Clamping screw	Nm
Stripping length / Blade size	mm/-

In accordance with IEC 60947-7-1

IEC	UL	CSA	EN 60079-7
800	600		
32	30		
4	AWG 26...10		
	8 kV / 3		
	A4 / V-0		

CE RoHS

Rated connection	Plug-in connection
0.5...6 / 0.5...6	
0.5...4 / 0.5...4	
0.5...0.6 / (M 3)	
9 / 0.6 x 3.5 mm	

Note

Ordering data

Version	dark beige
Note	

Type	Qty.	Order No.
WT4 4AN/2	50	1107680000

Accessories

Plug-in cross-connection	
	2-pole
	10-pole
End plate / Partition plate	dark beige
End bracket	dark beige
Miscellaneous accessories WeiCoS	
	Locking element
	Coding element
	Strain relief
Plug-in connector	
Screwdriver	Standard
Marking tags	

Type	Qty.	Order No.	
ZQV 4N/2	32 A	60	1527930000
ZQV 4N/10	32 A	20	1528090000
WAP WT4/4AN/2	50	1107780000	
WEW 35/2	50	1061200000	
ZVR ZP4	25	1855250000	
KOSF ZT4	50	1856860000	
ZZE ZP4	25	1855260000	
WP4/1AN/1	32 A	50	1107790000
WP4/1AN/1 ZA	32 A	50	1108490000
WP4/1AN/10	32 A	10	1107800000
SDS 0.6X3.5X100	1	2749340000	
DEK 5/6 MC NE WS	1000	1609820000	
DEK 5/6 MM WS	600	2007120000	
WS 8/6 MM WS	600	2007160000	

For detailed information on other accessories and application in the online catalogue





**Screw connection with clamping-yoke technology (W series)
Accessories – Pluggable terminal blocks**

Single plates for individual assembly

WeiCoS individual plates increase flexibility by providing a solution for every task. The plug-in connector is assembled directly on-site in line with application requirements. Each individual plate is available in green (GN) and beige (BE).

WeiCoS plug

- Single plates, plug ZP 2.5/1AN
- Marking option

Ordering data
2.5 mm ²
4.0 mm ²
Note

WP 2.5/1AN/1

Start plate



Type	Qty.	Order No.
WP 2.5/1AN/1	50	1305270000
WP4/1AN/1	50	1107790000

WP 2.5/1AN ZA 0.RA

Middle plate or end plate



Type	Qty.	Order No.
WP 2.5/1AN/1 ZA 0.RA	50	1351000000

WP 2.5/1AN ZA

Middle plate or end plate



Type	Qty.	Order No.
WP 2.5/1AN/1 ZA	50	1350990000
WP4/1AN/1 ZA	50	1108490000

Coding elements

- For specific coding of the plug-in stations
- Protection against accidental mistake ensures process reliability

Ordering data
2.5 mm ²
4.0 mm ²
Note

Coding

Coding elements



Type	Qty.	Order No.
APGCE	50	1514490000
KOSF ZT4	50	1856860000

Application



Interlock

- APGLE to interlock with the terminal block
- APGLE interlock, plug - socket

Ordering data
2.5 mm ² / 4 mm ²
Note

APGLE

Locking element



Type	Qty.	Order No.
APGLE 2.5/4	25	2457570000

Application APGLE



Strain reliefs / Protective cover

- APGSR Strain relief transmits mechanical forces to the plastic housing and protects the contact point

APGSR

Strain reliefs



Type	Qty.	Order No.
APGSR 2.5/4	25	2457580000
APGSR 2.5/4 - 4P	25	2457590000
APGSR 2.5/4 - 8P	25	2457600000
ZVR ZP4	25	1855250000

ZAD ZT / ZPS

Protective cover



Type	Qty.	Order No.
ZAD ZT/ZPS2.5	25	1861030000

Application APGSR



Ordering data
2.5 mm ²
2.5 mm ² / 4 mm ²
2.5 mm ² / 4 mm ²
2.5 mm ² / 4 mm ²
4.0 mm ²
Note



Screw connection with clamping-yoke technology (W-Series)
Pluggable terminal blocks

Universal range

A

WDU 2.5 F

2.5 mm²

Spade connection right

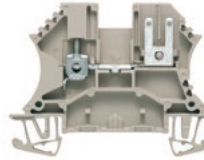

Width/Height/Depth	mm
max. current / max. cond. cross-section	A/mm ²
Max. clamping range	mm ²

5.1 x 60 x 46.25	F2.8 F2.8
12 / 4	
0.13...4	

IEC 61210, In accordance with IEC 60947-7-1

IEC	UL	CSA	EN 60079-7
500	300	300	
12	16	10	
2.5	AWG 22...12	AWG 26...12	
6 kV / 3			
A3 / V-0			

CE TÜV KECH UL NEMA

Rated connection	Plug-in connection
0.5...4 / 1.5...4	
0.5...4 / 0.5...2.5	
0.4...0.8 / (M 2.5)	
10 / 0.6 x 3.5 mm	

Technical data

Rated data	
Rated voltage	V
Rated current	A
for wire cross-section	mm ²
Rated impulse withstand voltage / Pollution severity	
Gauge to IEC 60947-1 / UL 94 flammability rating	
Approvals	
Clamped conductors (H05V/H07V)	
Solid / Stranded	mm ²
Flexible / Flexible with ferrule	mm ²
Tightening torque / Clamping screw	Nm
Stripping length / Blade size	mm/-

Note

Ordering data

Version	
	dark beige
Note	

Accessories

Screwable cross-connection	
	2-pole
	10-pole
End plate / Partition plate	
	dark beige
	Blue
	dark beige
	Blue
End bracket	
	dark beige
Cover	
	With lightning flash symbol
	Blank, white
Marking tags	

For detailed information on other accessories and application in the online catalogue

WDU 2.5 FF 2*2.8

1 mm²

Spade connection left and right

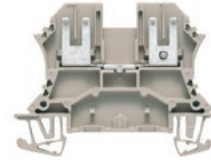

5.1 x 60 x 46.25	F2.8 F2.8	F2.8 F2.8
12 / 1		
...1		

IEC 61210, In accordance with IEC 60947-7-1

IEC	UL	CSA	EN 60079-7
500	300	300	
12	16	10	
1	AWG 22...14	AWG 26...12	
6 kV / 3			
/ V-0			

CE TÜV KECH UL NEMA

Rated connection	Plug-in connection
/	

Note

Ordering data

Type	Qty.	Order No.
WDU 2.5 FF 2X2.8	100	1021900000

Type	Qty.	Order No.
WQV 2.5/2	32 A 50	1053660000
WQV 2.5/10	32 A 20	1054460000
WAP 2.5-10	50	1050000000
WAP 2.5-10 BL	50	1050080000
WAP 16+35 WTW 2.5-10	20	1050100000
WAP 16+35 WTW 2.5-10 BL	20	1050180000
WEW 35/2	50	1061200000
WAD 4 GE BED	50	1072000000
WAD 4 WS	50	1072100000
DEK 5/5 MC NE WS	1000	1609801044
WS 12/5 MC NE WS	720	1609860000
DEK 5/5 MM WS	800	2007110000
WS 8/5 MM WS	800	2007150000

For detailed information on other accessories and application in the online catalogue

WDK 2.5 FF

1 mm²

Spade connection left and right

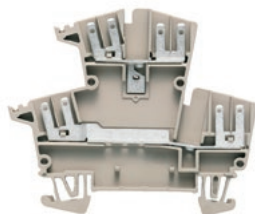

Width/Height/Depth	mm
max. current / max. cond. cross-section	A/mm ²
Max. clamping range	-

5.1 x 75.5 x 62.5
12 / 1
... 1

IEC 61210, In accordance with IEC 60947-7-1

Technical data

Rated data	
Rated voltage	V
Rated current	A
for wire cross-section	mm ²
Rated impulse withstand voltage / Pollution severity	
Gauge to IEC 60947-1 / UL 94 flammability rating	
Approvals	
Clamped conductors (H05V/H07V)	
Solid / Stranded	-
Flexible / Flexible with ferrule	-
Tightening torque / Clamping screw	-
Stripping length / Blade size	-/-

IEC	UL	CSA	EN 60079-7
400		300	
12		10	
1		AWG 26...12	
6 kV / 3			
/ V-0			

CE, TÜV, RoHS, N

Rated connection	Plug-in connection
/	/

Note

Ordering data

Version	dark beige
Note	

Type	Qty.	Order No.
WDK 2.5 FF	50	1021700000

Accessories

Screwable cross-connection	
	2-pole
	10-pole
End plate / Partition plate	
	dark beige
	Blue
	dark beige
End bracket	
	dark beige
Cover	
	With lightning flash symbol
	Blank, white
Marking tags	

Type	Qty.	Order No.
WQV 2.5/2	32 A 50	1053660000
WQV 2.5/10	32 A 20	1054460000
WAP WDK2.5	20	1059100000
WAP WDK2.5 BL	20	1059180000
WTW EN	20	1058800000
WEW 35/2	50	1061200000
WAD 4 GE BED	50	1072000000
WAD 4 WS	50	1072100000
DEK 5/5 MC NE WS	1000	1609801044
WS 8/5 MC NE WS	720	1640740000
DEK 5/5 MM WS	800	2007110000

For detailed information on other accessories and application in the online catalogue



**Screw connection with clamping-yoke technology (W-Series)
Pluggable terminal blocks**

WDU 1.5 BLZ 5.08 WQV

1.5 mm²

Screwable cross-connection

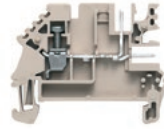

Width/Height/Depth	mm
max. current / max. cond. cross-section	A/mm ²
Max. clamping range	mm ²

5.08 x 49 x 37	WQV	BLZ 5.08
16 / 4		
0.13...4		BLZ 5.08

Technical data

Rated data	
Rated voltage	V
Rated current	A
for wire cross-section	mm ²
Rated impulse withstand voltage / Pollution severity	
Gauge to IEC 60947-1 / UL 94 flammability rating	
Approvals	
Clamped conductors (H05V/H07V)	
Solid / Stranded	mm ²
Flexible / Flexible with ferrule	mm ²
Tightening torque / Clamping screw	Nm
Stripping length / Blade size	mm/-

IEC 61210, In accordance with IEC 60947-7-1

IEC	UL	CSA	EN 60079-7
250	300	300	
16	20	10	
1.5	AWG 26...12	AWG 26...12	
4 kV / 3			
A3 / V-0			

CE		UL		CSA		EN	
Rated connection		Plug-in connection		Rated connection		Plug-in connection	
0.5...4 / 1.5...4		0.5...4 / 1.5...4		0.5...4 / 1.5...4		0.5...4 / 1.5...4	
0.5...4 / 0.5...2.5		0.5...4 / 0.5...2.5		0.5...4 / 0.5...2.5		0.5...4 / 0.5...2.5	
0.4...0.6 / (M 2.5)		0.4...0.6 / (M 2.5)		0.4...0.6 / (M 2.5)		0.4...0.6 / (M 2.5)	
10 / 0.6 x 3.5 mm		10 / 0.6 x 3.5 mm		10 / 0.6 x 3.5 mm		10 / 0.6 x 3.5 mm	

Note

Ordering data

Version	dark beige
Note	

Accessories

Plug-in cross-connection	
	2-pole
	10-pole
Screwable cross-connection	
	2-pole
	10-pole
End plate / Partition plate	
	Without peg
	With spigot
End bracket	
	dark beige
	dark beige, screwable
Mounting block for socket connector	
	Without peg
	With spigot
Plug-in connector	
Marking tags	
Miscellaneous accessories	
	Cover for unused pins
For detailed information on other accessories and application in the online catalogue	

Type	Qty.	Order No.
WDU 1.5/BLZ 5.08	100	1577340000

Type	Qty.	Order No.
WQV 2.5/2	32 A 50	1053660000
WQV 2.5/10	32 A 20	1054460000
WAP WDU1.5/BLZ	50	1577330000
WAP WDU1.5/BLZ/ZA	50	1577320000
WEW 35/2	50	1061200000
WBB WDU1.5/BL...	10	1068160000
WBB ZA WDU1.5/BL 10/10	10	1068260000
BLZP 5.08HC/04/180 SN OR BX	90	1943600000
BLZP 5.08HC/06/180 SN OR BX	60	1943620000
BLZP 5.08HC/08/180 SN OR BX	42	1943640000
BLZP 5.08HC/04/180F SN OR BX	60	1944110000
BLZP 5.08HC/06/180F SN OR BX	42	1944130000
BLZP 5.08HC/08/180F SN OR BX	36	1944150000
DEK 5/5 MC NE WS	1000	1609801044
WS 12/5 MC SDR	144	1609870000
DEK 5/5 MM WS	800	2007110000

WDU 1.5 BLZ 5.08 ZQV

1.5 mm²

Plug-in cross-connection

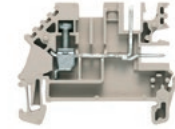

5.08 x 49 x 37	ZQV	BLZ5.08
16 / 4		
0.13...4		BLZ5.08

IEC 61984, In accordance with IEC 60947-7-1

IEC	UL	CSA	EN 60079-7
250	300	300	
16	20	20	
1.5	AWG 26...12	AWG 26...12	
4 kV / 3			
A3 / V-0			

CE		UL		CSA		EN	
Rated connection		Plug-in connection		Rated connection		Plug-in connection	
0.5...4 / 1.5...4		0.5...4 / 1.5...4		0.5...4 / 1.5...4		0.5...4 / 1.5...4	
0.5...4 / 0.5...2.5		0.5...4 / 0.5...2.5		0.5...4 / 0.5...2.5		0.5...4 / 0.5...2.5	
0.4...0.6 / (M 2.5)		0.4...0.6 / (M 2.5)		0.4...0.6 / (M 2.5)		0.4...0.6 / (M 2.5)	
10 / 0.6 x 3.5 mm		10 / 0.6 x 3.5 mm		10 / 0.6 x 3.5 mm		10 / 0.6 x 3.5 mm	

Note

Type	Qty.	Order No.
WDU 1.5/ZQV/BLZ 5.08	100	1784460000

Type	Qty.	Order No.
ZQV 2.5N/2	24 A 60	1527540000
ZQV 2.5N/10	24 A 20	1527690000
WAP WDU1.5/BLZ	50	1577330000
WAP WDU1.5/BLZ/ZA	50	1577320000
WEW 35/2	50	1061200000
WBB WDU1.5/BL...	10	1068160000
WBB ZA WDU1.5/BL 10/10	10	1068260000
BLZP 5.08HC/04/180 SN OR BX	90	1943600000
BLZP 5.08HC/06/180 SN OR BX	60	1943620000
BLZP 5.08HC/08/180 SN OR BX	42	1943640000
BLZP 5.08HC/04/180F SN OR BX	60	1944110000
BLZP 5.08HC/06/180F SN OR BX	42	1944130000
BLZP 5.08HC/08/180F SN OR BX	36	1944150000
DEK 5/5 MC NE WS	1000	1609801044
WS 12/5 MC SDR	144	1609870000
DEK 5/5 MM WS	800	2007110000
SCHT 7	20	0517960000
ZGB 30	20	1611930000

Screw connection with clamping-yoke technology (W-Series)

Terminal blocks with electronic components

WPO 4

4 mm²

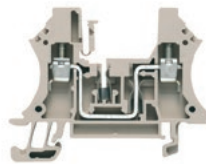

Width/Height/Depth	mm
max. current / max. cond. cross-section	A/mm ²
Max. clamping range	mm ²

6 x 60 x 46.5
32 / 4
0.13...4



Technical data

Rated data	
Rated voltage	V
Rated current	A
for wire cross-section	mm ²
Rated impulse withstand voltage / Pollution severity	
Gauge to IEC 60947-1 / UL 94 flammability rating	
Approvals	
Clamped conductors (H05V/H07V)	
Solid / Stranded	mm ²
Flexible / Flexible with ferrule	mm ²
Tightening torque / Clamping screw	Nm
Stripping length / Blade size	mm/-

IEC 60947-7-1

IEC	UL	CSA	EN 60079-7
250	300	300	
32	10	10	
4	AWG 26...12	AWG 26...12	
4 kV / 3			
A3 / V-0			

CE

Rated connection	
0.5...4	
0.5...4 / 0.5...2.5	
0.5...1 / (M 3)	
8 / 0.6 x 3.5 mm	

Note

Ordering data

Version	dark beige
Note	

Type	Qty.	Order No.
WPO 4	50	1036000000

Accessories

Intermediate frame	Thickness 2.5 mm
Busbar	
Marking tags	1 m

Type	Qty.	Order No.
ZR WPO4 DB	20	1071100000
SSCH 7.3X1.2X1000	1	1071200000
DEK 5/6 MC NE WS	1000	1609820000
WS 12/5 MC NE WS	720	1609860000
DEK 5/6 MM WS	600	2007120000
WS 8/6 MM WS	600	2007160000

For detailed information on other accessories and application in the online catalogue

WPO 4 with varistor

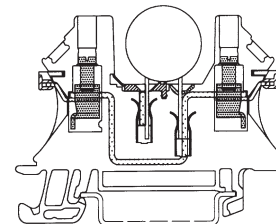

Weidmüller varistor terminals have been designed for the retrofitting of electronic components, e.g. varistors, diodes, gas discharge tubes, etc.

These "electronic terminals" no longer have to be configured prior to installation for subsequent delivery with soldered components which can no longer be distinguished.

The significant advantages of this design are:

- **Cost saving:**
Components can be changed quickly on site. Service requires only a visual inspection.
- **Clarity:**
Components are easy to distinguish.
- **Flexibility:**
Components can immediately be adapted to changed conditions.

Note:
Never change electronic components under load!

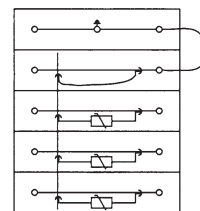

Overvoltages in a 3-phase supply discharged to earth via WPE 4 with the aid of varistors and a gas discharge tube.

For detailed information on other accessories and application in the online catalogue

WDUL 4/...

4 mm²

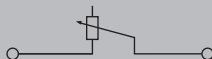
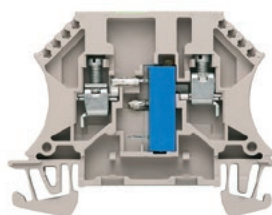

Width/Height/Depth	mm
max. current / max. cond. cross-section	A/mm ²
Max. clamping range	mm ²

6.5 x 60 x 46.5
6 / 6
0.13...6

Technical data

Rated data	
Rated voltage	-
Rated current	mA
for wire cross-section	mm ²
Rated impulse withstand voltage / Pollution severity	
Gauge to IEC 60947-1 / UL 94 flammability rating	
Approvals	

Clamped conductors (H05V/H07V)

Solid / Stranded	mm ²
Flexible / Flexible with ferrule	mm ²
Tightening torque / Clamping screw	Nm
Stripping length / Blade size	mm/-

Component potentiometer

Type potentiometer	
Resistance	
Tolerance (%)	

Note

Ordering data

Version	
	10 Ω
	100 Ω
	500 Ω
	1 kΩ
	5 kΩ
	10 kΩ
	50 kΩ
	500 kΩ
	without potentiometer

Note

Accessories

End plate / Partition plate	dark beige
	dark beige
End bracket	dark beige
Screwdriver	With "swifty set" cutting device
	Standard
Shield bus	
Marking tags	

IEC 60947-7-1

IEC	UL	CSA	EN 60079-7
120			
4			
		/ 3	
		A4 / V-0	

CE

Rated connection

0.5...6 / 1.5...6
0.5...4 / 0.5...2.5
0.6...0.8 / (M 3)
9 / 0.6 x 3.5 mm

Trim potentiometer, linear

100hm

10%

Technical data for the 10 Ω compensating resistor

Resistor material: "Cermet"

Resistor setting range: 0...10 Ω

Wave form: linear

Temperature coefficient: 100 ppm/°C

Mechanical lifespan: 200 operations without permissible deviations, across the entire resistance range

Resistance change per spindle turn: ≈ 0,4 Ω

Rated output for total resistance: 1 watt at 70 °C

Rated current: 300 mA

Ambient temperature: -55 °C to +70 °C

Ingress (seal) protection:

- 1) Leak tested in water at 70 °C without bubble formation
- 2) Storage in SFW 2.0 S, acc. to DIN 50018, 9 cycles

Capacity expressed in % of rated load

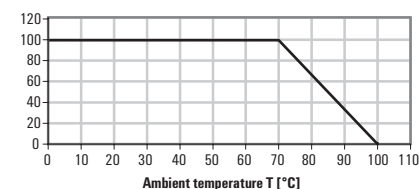

For detailed information on other accessories and application in the online catalogue



Screw connection with clamping-yoke technology (W-Series)

Terminal blocks with electronic components

Universal range

A

WDK 2.5/D

2.5 mm²

Reverse polarity protection

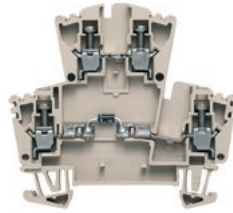

WDK 2.5/D/1

2.5 mm²

Suppression circuit e. g. for contactor

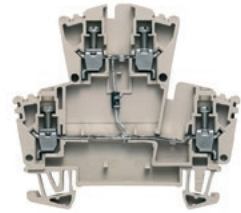

Width/Height/Depth	mm
max. current / max. cond. cross-section	A/mm ²
Max. clamping range	mm ²

5.1 x 69 x 62.5	
0.5 / 4	
0.05...4	

5.1 x 69 x 62.5	
0.5 / 4	
0.05...4	

Technical data

Rated data	
Rated voltage of feed-through terminal	-
Rated current	A
for wire cross-section	mm ²
Rated impulse withstand voltage / Pollution severity	
Gauge to IEC 60947-1 / UL 94 flammability rating	
Component 1	
Approvals	
Clamped conductors (H05V/H07V)	
Solid / Stranded	mm ²
Flexible / Flexible with ferrule	mm ²
Tightening torque / Clamping screw	Nm
Stripping length / Blade size	mm/-
Component diode	
Type diode	
Forward current	
Reverse voltage	
Forward voltage	
Component LED	
Colour	
Voltage, min.	
Voltage, max.	
Current	
Component resistor	
Resistance	
Power loss	
Tolerance (%)	
Note	

IEC 60947-1			
IEC	UL	CSA	EN 60079-7
400	300		
0.5	20		
2.5	AWG 22...12		
6 kV / 3			
A3 / V-0			
Diode 1N 4007 /			
CE ENEC			
Rated connection			
0.5...4 / 1.5...4			
0.5...4			
0.4...0.6 / (M 2.5)			
10 / 0.6 x 3.5 mm			
1N4007			
1A			
1300V			
0.7V			
Note			

IEC 60947-1			
IEC	UL	CSA	EN 60079-7
400	300	300	
0.5	20	1	
2.5	AWG 22...12	AWG 26...12	
6 kV / 3			
A3 / V-0			
Diode 1N 4007 /			
CE			
Rated connection			
0.5...4 / 1.5...4			
0.5...4			
0.4...0.6 / (M 2.5)			
10 / 0.6 x 3.5 mm			
1N4007			
1A			
1300V			
0.7V			
Note			

Ordering data

Version	
	dark beige
	dark beige (red LED)
	dark beige (green LED)
Note	

Type	Qty.	Order No.
WDK 2.5 1D	25	8025610000
Note		

Type	Qty.	Order No.
WDK 2.5 1D A.1	25	1023400000
Note		

Accessories

Screwable cross-connection	
	2-pole
	10-pole
End plate / Partition plate	
	dark beige
End bracket	
	dark beige
Screwdriver	
	With "swifty set" cutting device
	Standard
Marking tags	

Type	Qty.	Order No.
WQV 2.5/2	32 A 50	1053660000
WQV 2.5/10	32 A 20	1054460000
WAP WDK2.5	20	1059100000
WEW 35/2	50	1061200000
SWIFTY SET	1	9006060000
SDS 0.6X3.5X100	1	2749340000
DEK 5/5 MC NE WS	1000	1609801044
WS 8/5 MC NE WS	720	1640740000
DEK 5/5 MM WS	800	2007110000

Type	Qty.	Order No.
WQV 2.5/2	32 A 50	1053660000
WQV 2.5/10	32 A 20	1054460000
WAP WDK2.5	20	1059100000
WEW 35/2	50	1061200000
SWIFTY SET	1	9006060000
SDS 0.6X3.5X100	1	2749340000
DEK 5/5 MC NE WS	1000	1609801044
WS 8/5 MC NE WS	720	1640740000
DEK 5/5 MM WS	800	2007110000

For detailed information on other accessories and application in the online catalogue

For detailed information on other accessories and application in the online catalogue

WDK 2.5/D/2

2.5 mm²

Suppression circuit e. g. for contactor



5.1 x 69 x 62.5
0.5 / 4
0.05...4



IEC 60947-7-1

IEC	UL	CSA	EN 60079-7
400	300	300	
0.5	20	1	
2.5	AWG 22...12	AWG 26...12	
6 kV / 3			
A3 / V-0			
Diode 1N 4007 /			

CE

Rated connection

0.5...4 / 1.5...4
0.5...4
0.4...0.6 / (M 2.5)
10 / 0.6 x 3.5 mm

1N4007
1A
1300V
0.7V

Type	Qty.	Order No.
WDK 2.5 1D A.2	25	1023300000

Type	Qty.	Order No.
WQV 2.5/2	32 A 50	1053660000
WQV 2.5/10	32 A 20	1054460000
WAP WDK2.5	20	1059100000
WEW 35/2	50	1061200000
SWIFTY SET	1	9006060000
SDS 0.6X3.5X100	1	2749340000
DEK 5/5 MC NE WS	1000	1609801044
WS 8/5 MC NE WS	720	1640740000
DEK 5/5 MM WS	800	2007110000

WDK 2.5/D/3

2.5 mm²

5.1 x 69 x 62.5



5.1 x 69 x 62.5
24 / 4
0.05...4

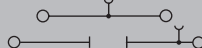

IEC 60947-7-1

IEC	UL	CSA	EN 60079-7
400			
0.5			
2.5			
6 kV / 3			
A3 / V-0			

CE

Rated connection

0.5...4 / 1.5...4
0.5...4
0.4...0.6 / (M 2.5)
10 / 0.6 x 3.5 mm

Type	Qty.	Order No.
WDK 2.5/D/3	50	1023100000

Type	Qty.	Order No.
WQV 2.5/2	32 A 50	1053660000
WQV 2.5/10	32 A 20	1054460000
WAP WDK2.5	20	1059100000
WEW 35/2	50	1061200000
SWIFTY SET	1	9006060000
SDS 0.6X3.5X100	1	2749340000
DEK 5/5 MC NE WS	1000	1609801044
WS 8/5 MC NE WS	720	1640740000
DEK 5/5 MM WS	800	2007110000

WDK 2.5/D/4

2.5 mm²

Lamp test circuits

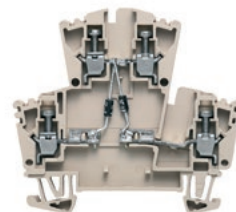

5.1 x 69 x 62.5
0.5 / 4
0.05...4

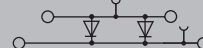

IEC 60947-7-1

IEC	UL	CSA	EN 60079-7
400	300		
0.5	20		
2.5	AWG 22...12		
6 kV / 3			
A3 / V-0			
Diode 1N 4007 / Diode 1N 4007			

CE

Rated connection

0.5...4 / 1.5...4
0.5...4
0.4...0.6 / (M 2.5)
10 / 0.6 x 3.5 mm

1N4007
1A
1300V
0.7V

Type	Qty.	Order No.
WDK 2.5 2D 1.A	25	8014670000

Type	Qty.	Order No.
WQV 2.5/2	32 A 50	1053660000
WQV 2.5/10	32 A 20	1054460000
WAP WDK2.5	20	1059100000
WEW 35/2	50	1061200000
SWIFTY SET	1	9006060000
SDS 0.6X3.5X100	1	2749340000
DEK 5/5 MC NE WS	1000	1609801044
WS 8/5 MC NE WS	720	1640740000
DEK 5/5 MM WS	800	2007110000



Screw connection with clamping-yoke technology (W-Series)

Terminal blocks with electronic components

Universal range

A

WDK 2.5/D/5

2.5 mm²

Lamp test circuits

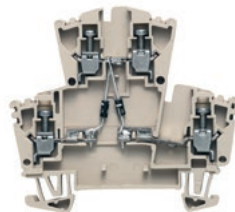

WDK 2.5/D/6

2.5 mm²

Lamp test circuits

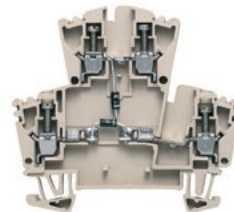

Width/Height/Depth	mm
max. current / max. cond. cross-section	A/mm ²
Max. clamping range	mm ²

5.1 x 69 x 62.5
0.5 / 4
0.05...4

5.1 x 69 x 62.5
0.5 / 4
0.05...4

Technical data

Rated data	
Rated voltage of feed-through terminal	V
Rated current	A
for wire cross-section	mm ²
Rated impulse withstand voltage / Pollution severity	
Gauge to IEC 60947-1 / UL 94 flammability rating	

IEC 60947-7-1			
IEC	UL	CSA	EN 60079-7
400	300	300	
0.5	20	10	
2.5	AWG 22...12	AWG 26...12	
6 kV / 3			
A3 / V-0			
Diode 1N 4007 / Diode 1N 4007			

IEC 60947-7-1			
IEC	UL	CSA	EN 60079-7
400	300	300	
0.5	20	10	
2.5	AWG 22...12	AWG 26...12	
6 kV / 3			
A3 / V-0			
Diode 1N 4007 / Diode 1N 4007			

Component 1

Approvals

Clamped conductors (H05V/H07V)

Solid / Stranded	mm ²
Flexible / Flexible with ferrule	mm ²
Tightening torque / Clamping screw	Nm
Stripping length / Blade size	mm/-

Component diode

Type diode	1N4007
Forward current	1A
Reverse voltage	1300V
Forward voltage	0.7V

Component LED

Colour	
Voltage, min.	
Voltage, max.	
Current	

Component resistor

Resistance	
Power loss	
Tolerance (%)	

Note

Ordering data

Version	
	dark beige
	dark beige (red LED)
	dark beige (green LED)

Note

Type	Qty.	Order No.
WDK 2.5 2D 2.A	25	1022600000

Type	Qty.	Order No.
WDK 2.5 2D	25	1023500000

Accessories

Screwable cross-connection	
	2-pole
	10-pole

End plate / Partition plate	
	dark beige

End bracket	
	dark beige

Screwdriver	
	With "swifty set" cutting device
	Standard

Marking tags

Type	Qty.	Order No.
WQV 2.5/2	32 A 50	1053660000
WQV 2.5/10	32 A 20	1054460000
WAP WDK2.5	20	1059100000
WEW 35/2	50	1061200000
SWIFTY SET	1	9006060000
SDS 0.6X3.5X100	1	2749340000
DEK 5/5 MC NE WS	1000	1609801044
WS 8/5 MC NE WS	720	1640740000
DEK 5/5 MM WS	800	2007110000

Type	Qty.	Order No.
WQV 2.5/2	32 A 50	1053660000
WQV 2.5/10	32 A 20	1054460000
WAP WDK2.5	20	1059100000
WEW 35/2	50	1061200000
SWIFTY SET	1	9006060000
SDS 0.6X3.5X100	1	2749340000
DEK 5/5 MC NE WS	1000	1609801044
WS 8/5 MC NE WS	720	1640740000
DEK 5/5 MM WS	800	2007110000

For detailed information on other accessories and application in the online catalogue

WDK 2.5/D

2.5 mm²

For installing electronic components



5.1 x 69.5 x 62.5
24 / 4
0.05...4

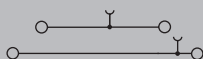

IEC 60947-7-1

IEC	UL	CSA	EN 60079-7
400			
10			
2.5			
	6 kV / 3		
	A3 / V-0		

CE EMC

Rated connection

0.5...4 / 1.5...4
0.5...4 / 0.5...2.5
0.4...0.6 / (M 2.5)
10 / 0.6 x 3.5 mm

WDK 2.5 LD +-

2.5 mm²

DC voltage indicator +/-

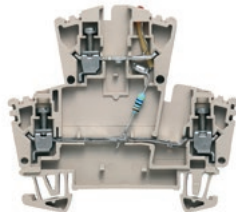

5.1 x 69 x 62.5
10 / 4
0.13...4



IEC 60947-7-1

IEC	UL	CSA	EN 60079-7
24			
2.5			
	0.8 kV / 3		
	A3 / V-0		

CE EMC

Rated connection

0.5...4 / 1.5...4
0.5...4
0.4...0.6 / (M 2.5)
10 / 0.6 x 3.5 mm

red

6V

24V

20mA

4.7kOhm

0.4W

1%

WDK 2.5 LD - +

2.5 mm²

DC voltage indicator - / +

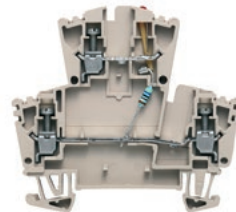

5.1 x 69 x 62.5
10 / 4
0.13...4



IEC 60947-7-1

IEC	UL	CSA	EN 60079-7
24			
2.5			
	0.8 kV / 3		
	A3 / V-0		

CE EMC

Rated connection

0.5...4 / 1.5...4
0.5...4
0.4...0.6 /
10 / 0.6 x 3.5 mm

red

6V

24V

20mA

4.7kOhm

0.4W

1%

Type	Qty.	Order No.
WDK 2.5/D	100	1023200000

Type	Qty.	Order No.
WDK 2.5 LD RT 24VDC +-	25	1023600000
WDK 2.5 LD/GN 1R 24VDC	25	8023610000

Type	Qty.	Order No.
WDK 2.5 LD RT 24VDC +-	25	8023630000
WDK 2.5 LD GR 1R 24VDC	25	8010040000

Type	Qty.	Order No.
WQV 2.5/2	32 A 50	1053660000
WQV 2.5/10	32 A 20	1054460000
WAP WDK2.5	20	1059100000
WEW 35/2	50	1061200000
SWIFTY SET	1	9006060000
SDS 0.6X3.5X100	1	2749340000
DEK 5/5 MC NE WS	1000	1609801044
WS 8/5 MC NE WS	720	1640740000
DEK 5/5 MM WS	800	2007110000

Type	Qty.	Order No.
WQV 2.5/2	32 A 50	1053660000
WQV 2.5/10	32 A 20	1054460000
WAP WDK2.5	20	1059100000
WEW 35/2	50	1061200000
SWIFTY SET	1	9006060000
SDS 0.6X3.5X100	1	2749340000
DEK 5/5 MC NE WS	1000	1609801044
WS 8/5 MC NE WS	720	1640740000
DEK 5/5 MM WS	800	2007110000

Type	Qty.	Order No.
WQV 2.5/2	32 A 50	1053660000
WQV 2.5/10	32 A 20	1054460000
WAP WDK2.5	20	1059100000
WEW 35/2	50	1061200000
SWIFTY SET	1	9006060000
SDS 0.6X3.5X100	1	2749340000
DEK 5/5 MC NE WS	1000	1609801044
WS 8/5 MC NE WS	720	1640740000
DEK 5/5 MM WS	800	2007110000



Screw connection with clamping-yoke technology (W-Series)
Mini terminal blocks for enclosure wiring

Universal range

A

MK 2/12

2.5 mm²

MK 3/2...12

2.5 mm²

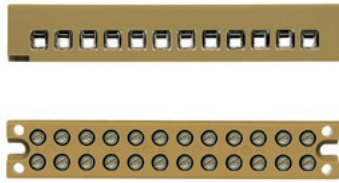

Width/Height/Depth	mm
max. current / max. cond. cross-section	A/mm ²
Max. clamping range	mm ²

15 x 86 x 15
24 / 4
0.2...4

Technical data

Rated data	
Rated voltage	
Rated current	
for wire cross-section	
Rated impulse withstand voltage / Pollution severity	
Gauge to IEC 60947-1 / UL 94 flammability rating	
Approvals	
Clamped conductors (H05V/H07V)	
Solid / Stranded	
Flexible / Flexible with ferrule	
Tightening torque / Clamping screw	
Stripping length / Blade size	

IEC 60947-7-1			
IEC	UL	CSA	EN 60079-7
125	300	300	
24	10	10	
2.5	AWG 24...12	AWG 24...12	
2.5 kV / 3			
A2 / V-2			
Rated connection			
0.5...4 / 1.5...2.5			
0.5...2.5 / 0.5...1.5			
...0.4 / (M 2.5)			
5 / 0.6 x 3.5 mm			

IEC 60947-7-1			
IEC	UL	CSA	EN 60079-7
400	300	300	
24	20	25	
2.5	AWG 22...12	AWG 22...12	
6 kV / 3			
A2 / 5VA			
Rated connection			
0.5...4 / 1.5...2.5			
0.5...2.5 / 0.5...1.5			
0.4...0.45 / (M 2.5)			
5 / 0.6 x 3.5 mm			

Note

Ordering data

Sorting of order data TK 1/SAK	
2-pole	
3-pole	
4-pole	
5-pole	
6-pole	
7-pole	
8-pole	
10-pole	
12-pole	
16-pole	

Type	Height	Mounting	Qty.	Order No.
MK 2/12	86	80	50	0241260000

Type	Height	Mounting	Qty.	Order No.
MK 3/2	15	18.5	100	0273820000
MK 3/3	15	18.5	50	0273920000
MK 3/4	15	18.5	50	0274020000
MK 3/5	15	18.5	50	0274120000
MK 3/6	15	37	50	0274220000
MK 3/7	15	37	50	0274320000
MK 3/8	15	55.5	25	0274420000
MK 3/10	15	74	20	0274620000
MK 3/12	15	92.5	20	0243520000

Note

For detailed information on other accessories and application in the online catalogue

MK 4/16

2.5 mm²

MK 6/2...6/6

6 mm²



IEC 60947-7-1

IEC	UL	CSA	EN 60079-7
400	150	150	
24	15	15	
2.5	AWG 24...12	AWG 22...12	
6 kV / 3			
A2 / 5VA			

CE ENEC KEMA TUV

Rated connection

0.5...4 / 1.5...2.5

0.5...2.5 / 0.5...1.5

0.4...0.45 / (M 2.5)

5 / 0.6 x 3.5 mm

IEC 60947-7-1

IEC	UL	CSA	EN 60079-7
690	300	300	
41	30	40	
6	AWG 22...10	AWG 22...10	
8 kV / 3			
A3 / 5VA			

CE ENEC KEMA TUV

Rated connection

0.5...6 / 1.5...6

0.5...6 / 0.5...4

1.2...2 / (M 4)

9 / 4.0 x 0.8 mm

Type	Height	Mounting	Qty.	Order No.
MK 4/16	103	85.5	20	0244220000

Type	Height	Mounting	Qty.	Order No.
MK 6/2	23.5		50	0620420000
MK 6/3	36.5	13	50	0620320000
MK 6/4	49.5	26	20	0620220000
MK 6/6	75.5	52	20	0620120000



Screw connection with clamping-yoke technology (W-Series)

Mini terminal blocks for enclosure wiring

MK 5/2 0.DE

2.5 mm²

BK 2...12

4 mm²



Width/Height/Depth	mm
max. current / max. cond. cross-section	A/mm ²
Max. clamping range	mm ²

18 x 40 x 14.2
24 / 4
0.2...4

Technical data

Rated data	
Rated voltage	
Rated current	
for wire cross-section	
Rated impulse withstand voltage / Pollution severity	
Gauge to IEC 60947-1 / UL 94 flammability rating	
Approvals	
Clamped conductors (H05V/H07V)	
Solid / Stranded	
Flexible / Flexible with ferrule	
Tightening torque / Clamping screw	
Stripping length / Blade size	

IEC	UL	CSA	EN 60079-7
500		300	
24		25	
2.5		AWG 20...14	
6 kV / 3			
A2 / 5VA			
CE CB CB			
Rated connection			
0.5...4 / 1.5...2.5			
0.5...2.5 / 0.5...1.5			
0.4 / (M 2.5)			
5 / 0.6 x 3.5 mm			

Note

Ordering data

Sorting of order data TK 1/SAK	
2-pole	
3-pole	
4-pole	
6-pole	
12-pole	

Note

Accessories

Lid / cover

Type	Height	Mounting	Qty.	Order No.
MK 5/2 0.DE	40	32	100	0243820000

Type	Qty.	Order No.
D 2 MK5/2 PA/NA	50	0244060000

IEC 60947-7-1

IEC	UL	CSA	EN 60079-7
400	150	300	
32	20	10	
4	AWG 26...12	AWG 22...12	
6 kV / 3			
A3 / V-0, 5VA			

CE CB CB CB CB CB

Rated connection	
0.5...4 / 1.5...4	
0.5...4 / 0.5...4	
0.5...0.6 / (M 3)	
8 / 4.0 x 0.8 mm	

Two solid (single-core) conductors of equal cross-section (0.5 .. 1.5 mm²) can be connected.

Type	Height	Mounting	Qty.	Order No.
BK 2 CRN	20		100	0624720000
BK 3 CRN	31	11	100	0624920000
BK 4 CRN	38	18	100	0625120000
BK 6 CRN	52	32	50	0625220000
BK 12 CRN	92	72.5	25	0625320000

For detailed information on other accessories and application in the online catalogue



Screw connection with clamping-yoke technology (W-Series)

Mini terminal blocks for enclosure wiring

Universal range

A

BK 2...12/E

4 mm²

Solid / stranded
Flexible / flexible with wire-end ferrule



MK 3/2...12/E

2.5 mm²

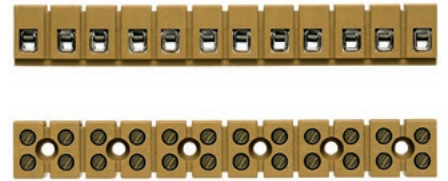

Width/Height/Depth	mm
max. current / max. cond. cross-section	A/mm ²
Max. clamping range	mm ²

22 x 92 x 20
32 / 4
0.33...4

Technical data

Rated data	
Rated voltage	400
Rated current	32
for wire cross-section	4
Rated impulse withstand voltage / Pollution severity	6 kV / 3
Gauge to IEC 60947-1 / UL 94 flammability rating	A3 / V-0, 5VA
Approvals	
Clamped conductors (H05V/H07V)	
Solid / Stranded	0.5...4 / 1.5...4
Flexible / Flexible with ferrule	0.5...4 / 0.5...4
Tightening torque / Clamping screw	0.5...0.6 / (M 3)
Stripping length / Blade size	8 / 4.0 x 0.8 mm

IEC 60947-7-1 Ex eb II C GbII
2 G D

IEC	UL	CSA	EN 60079-7
400	150	300	275
32	20	10	28
4	AWG 26...12	AWG 22...12	4 mm ²

6 kV / 3
A3 / V-0, 5VA

BAS 98ATEX3084 U

Rated connection	
0.5...4 / 1.5...4	
0.5...4 / 0.5...4	
0.5...0.6 / (M 3)	
8 / 4.0 x 0.8 mm	

Note

Two solid (single-core) conductors of equal cross-section (0.5 .. 1.5 mm²) can be connected.

Ordering data

Sorting of order data TK 1/SAK	
2-pole	BK 2/E
3-pole	BK 3/E
4-pole	BK 4/E
5-pole	
6-pole	BK 6/E
8-pole	
12-pole	BK 12/E

Type	Height	Mounting	Qty.	Order No.
BK 2/E	20		100	7906040000
BK 3/E	31	11	100	7906060000
BK 4/E	38	18	100	7906080000
BK 6/E	52	32	50	7906090000
BK 12/E	92	72.5	25	7906100000

Note

*DU = feed-through terminals, PE = PE terminals

IEC 60947-7-1 Ex eb II C GbII
2 G D

IEC	UL	CSA	EN 60079-7
400	300	300	275
24	20	25	24
2.5	AWG 22...12	AWG 22...12	4 mm ²

6 kV / 3
A2 / 5VA

BAS 99ATEX2124 U

Rated connection	
0.5...4 / 1.5...2.5	
0.5...2.5 / 0.5...1.5	
0.4...0.45 / (M 2.5)	
5 / 0.6 x 3.5 mm	

Note

Type	Height	Mounting	Qty.	Order No.
MK 3/2/E	15	18.5	100	7906110000
MK 3/3/E	15	18.5	50	7906120000
MK 3/4/E	15	18.5	50	7906130000
MK 3/6/E	15	37	50	7906150000
MK 3/8/E	15	55.5	25	7906170000
MK 3/12/E	110	92.5	20	7906210000

Note

For detailed information on other accessories and application in the online catalogue

MK 6/2...6/E

6 mm²



Ex eb II C GbII

2 G D



IEC 60947-7-1

IEC	UL	CSA	EN 60079-7
690	300		440
41	30		36
6	AWG 22...10		6 mm ²

8 kV / 3

A3 / 5VA



BAS 99ATEX2123 U

Rated connection

0.5...6 / 1.5...6

0.5...6 / 0.5...4

1.2...1.2 / (M 4)

9 / 4.0 x 0.8 mm



Type	Height	Mounting	Qty.	Order No.
MK 6/2/E	23.5		50	7906220000
MK 6/3/E	36.5	13	50	7906230000
MK 6/4/E	49.5	26	20	7906240000
MK 6/5/E	62.5	26	20	7906250000
MK 6/6/E	75.5	52	20	7906260000



ZQV plug-in cross-connection

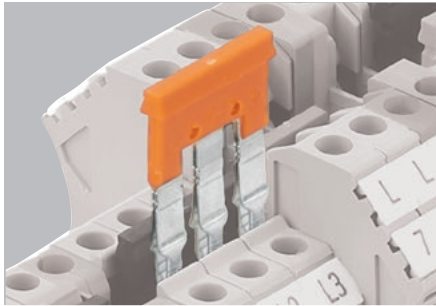

Weidmüller is the leading manufacturer of plug-in cross connection systems for screw clamp terminals. The plug-in cross-connections stand out with their easy handling and quick assembly, resulting in considerable time savings compared to screwed assembly solutions. This also ensures that all poles remain securely in contact.

Assembly / Technical information

- The ZQV is pressed into the cross-connection channel by hand.
- **Important!** Ensure that the ZQV is pressed right in. The cross-connection must not protrude out of the cross-connection channel.
- To replace or remove, simply lever out with a screwdriver.
- Reduced rated voltage 400 V
- Different colours can be used to mark different potential
- **Important!** The contact elements must not be deformed

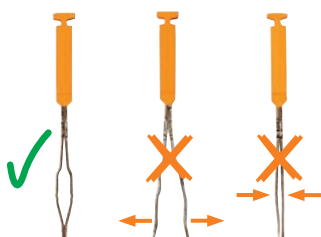

In one cross-connection channel

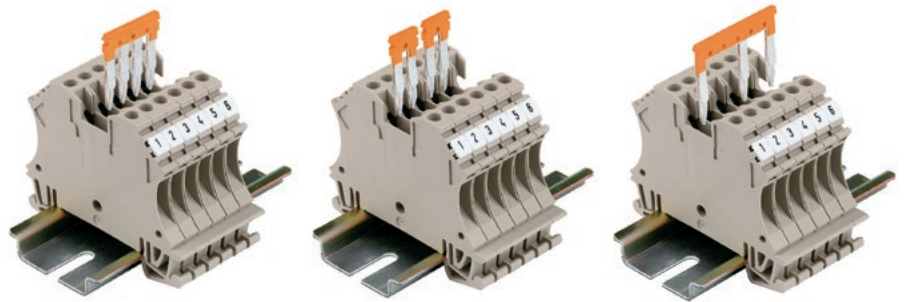

In two cross-connection channels

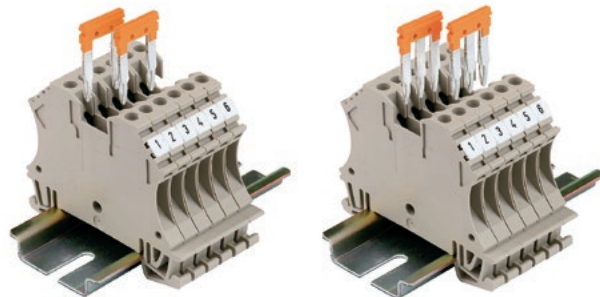

Possible cross-connections of terminals of the same type with corresponding cross-connectors

Terminal type	Cross-connector	single	adjacent	bridging	parallel bridging	parallel lengthening
Standard						
WDU 1.5/ R3.5	ZQV 1.5/ R3.5	•	•	•		
WDK 1.5/ R3.5	ZQV 1.5/ R3.5	•	•	•		
WDU 2.5/1.5/ZR	ZQV 2.5N	•	•	•	•	•
WDU 2.5	ZQV 2.5N	•	•	•	•	•
WDK 2.5 ZQV	ZQV 2.5N	•	•	•		
WTR 2.5/ZZ	ZQV 2.5	•	•	•		
WDU 4	ZQV 4N	•	•	•	•	•
WTR 4...	ZQV 4N	•	•	•		
WDU/PE/4ZZ/ZR	ZQV 4N	•	•	•	•	•
WTR 4/ZZ/ZR	ZQV 4N	•	•	•		
Compact						
WDU 2.5N ZQV	ZQV 2.5N	•	•	•	•	•
WDK 2.5N...	ZQV 2.5N	•	•	•		
WDK 2.5N PE	ZQV 2.5N	•	•	•		
WDU 4N	ZQV 4N	•	•	•	•	•
WDK 4N...	ZQV 4N	•	•	•		
WDK 4N PE	ZQV 4N	•	•	•		

Continuous cross-connection

ZQV 2.5N/20 (20-pole) and ZQV 4N/20 (20-pole) are ideal for shortening (e.g. with tool KT ZQV - 9002170000) to produce customised configurations with the required number of poles.

More than 20 poles in a row are not recommended because of the resulting tolerances in the terminals.

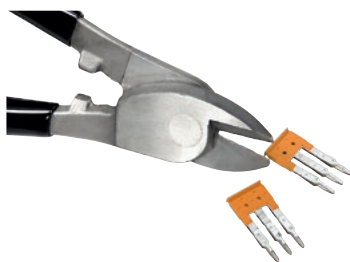

Special features of

WDU 2.5, WDU 4 und WDU 2.5/1.5/ZR

- Parallel distribution of 3 potentials
Important! Rated voltage reduced to 125 V!
- Parallel distribution of 2 potentials
Important! Only when using the outer cross-connection holes at 400 V
- The middle cross-connection hole can be used for either ZQV or WQV

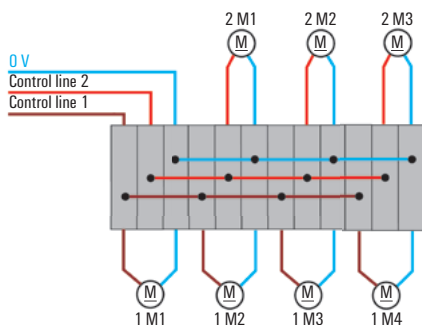

Important! By using manually cut ZQV and cross-connections with blank cut edges (> 10 poles) the voltage reduces to 25 V.

Screw connection with clamping-yoke technology (W-Series)
Accessories - Potential distribution

Cross-connection

ZQV 2.5N

ZQV 4N

Universal range

A



Technical data	
Rated current	A
Ordering data	
2-pole	
3-pole	
4-pole	
5-pole	
6-pole	
7-pole	
8-pole	
9-pole	
10-pole	
20-pole	
41-poles	
50-pole	
Note	

24			
Type	Qty.	Order No.	
ZQV 2.5N/2	60	1527540000	
ZQV 2.5N/3	60	1527570000	
ZQV 2.5N/4	60	1527590000	
ZQV 2.5N/5	20	1527620000	
ZQV 2.5N/6	20	1527630000	
ZQV 2.5N/7	20	1527640000	
ZQV 2.5N/8	20	1527670000	
ZQV 2.5N/9	20	1527680000	
ZQV 2.5N/10	20	1527690000	
ZQV 2.5N/20	20	1527720000	
ZQV 2.5N/50	5	1527730000	

32			
Type	Qty.	Order No.	
ZQV 4N/2	60	1527930000	
ZQV 4N/3	60	1527940000	
ZQV 4N/4	60	1527970000	
ZQV 4N/5	60	1527980000	
ZQV 4N/6	20	1527990000	
ZQV 4N/7	20	1528020000	
ZQV 4N/8	20	1528030000	
ZQV 4N/9	20	1528070000	
ZQV 4N/10	20	1528090000	
ZQV 4N/20		2883800000	
ZQV 4N/41		2883810000	
ZQV 4N/50	5	1528130000	



Technical data	
Rated current	A
Ordering data	
2-pole	
3-pole	
4-pole	
5-pole	
6-pole	
7-pole	
8-pole	
9-pole	
10-pole	
20-pole	
41-poles	
50-pole	
Note	

24			
Type	Qty.	Order No.	
ZQV 2.5N/2 BL	60	1527740000	
ZQV 2.5N/3 BL	60	1527770000	
ZQV 2.5N/4 BL	60	1527780000	
ZQV 2.5N/5 BL	20	1527790000	
ZQV 2.5N/6 BL	20	1527820000	
ZQV 2.5N/7 BL	20	1527830000	
ZQV 2.5N/8 BL	20	1527840000	
ZQV 2.5N/9 BL	20	1527870000	
ZQV 2.5N/10 BL	20	1527880000	
ZQV 2.5N/20 BL	20	1527890000	
ZQV 2.5N/50 BL	5	1527920000	

32			
Type	Qty.	Order No.	
ZQV 4N/2 BL	60	1528040000	
ZQV 4N/3 BL	60	1528080000	
ZQV 4N/4 BL	60	1528120000	
ZQV 4N/5 BL	60	1528140000	
ZQV 4N/6 BL	20	1528170000	
ZQV 4N/7 BL	20	1528180000	
ZQV 4N/8 BL	20	1528190000	
ZQV 4N/9 BL	20	1528220000	
ZQV 4N/10 BL	20	1528230000	
ZQV 4N/20 BL	20	2810850000	
ZQV 4N/41 BL		2883820000	
ZQV 4N/50 BL	5	1528240000	



Technical data	
Rated current	A
Ordering data	
2-pole	
3-pole	
4-pole	
5-pole	
6-pole	
7-pole	
8-pole	
9-pole	
10-pole	
20-pole	
41-poles	
50-pole	
Note	

24			
Type	Qty.	Order No.	
ZQV 2.5N/2 RD	60	2108470000	
ZQV 2.5N/3 RD	60	2108690000	
ZQV 2.5N/4 RD	60	2108700000	
ZQV 2.5N/5 RD	20	2108710000	
ZQV 2.5N/6 RD	20	2108720000	
ZQV 2.5N/7 RD	20	2108810000	
ZQV 2.5N/8 RD	20	2108870000	
ZQV 2.5N/9 RD	20	2108900000	
ZQV 2.5N/10 RD	20	2108910000	
ZQV 2.5N/20 RD	20	2108920000	
ZQV 2.5N/50 RD	5	2109000000	

32			
Type	Qty.	Order No.	
ZQV 4N/2 RD	60	2460450000	
ZQV 4N/3 RD	60	2460810000	
ZQV 4N/4 RD	60	2460800000	
ZQV 4N/5 RD	60	2460790000	
ZQV 4N/6 RD	20	2460780000	
ZQV 4N/7 RD	20	2460770000	
ZQV 4N/8 RD	20	2460760000	
ZQV 4N/9 RD	20	2460750000	
ZQV 4N/10 RD	20	2460740000	
ZQV 4N/20 RD	20	2810860000	
ZQV 4N/41 RD		2883840000	
ZQV 4N/50 RD	5	2460730000	

Cross-connection

ZQV 2.5N

ZQV 4N



Technical data	
Rated current	A
Ordering data	
2-pole	
3-pole	
4-pole	
5-pole	
6-pole	
7-pole	
8-pole	
9-pole	
10-pole	
20-pole	
41-poles	
50-pole	
Note	

24			
Type	Qty.	Order No.	
ZQV 2.5N/2 WT	60	2831560000	
ZQV 2.5N/3 WT	60	2831570000	
ZQV 2.5N/4 WT	60	2831580000	
ZQV 2.5N/5 WT	20	2831590000	
ZQV 2.5N/6 WT	20	2831600000	
ZQV 2.5N/7 WT	20	2831610000	
ZQV 2.5N/8 WT	20	2831620000	
ZQV 2.5N/9 WT	20	2831630000	
ZQV 2.5N/10 WT	20	2831640000	
ZQV 2.5N/20 WT	20	2831650000	
ZQV 2.5N/50 WT	5	2831660000	

32			
Type	Qty.	Order No.	
ZQV 4N/2 WT	60	2831800000	
ZQV 4N/3 WT	60	2831810000	
ZQV 4N/4 WT	60	2831820000	
ZQV 4N/5 WT	60	2831830000	
ZQV 4N/6 WT	20	2831840000	
ZQV 4N/7 WT	20	2831850000	
ZQV 4N/8 WT	20	2831860000	
ZQV 4N/9 WT	20	2831870000	
ZQV 4N/10 WT	20	2831790000	



Technical data	
Rated current	A
Ordering data	
2-pole	
3-pole	
4-pole	
5-pole	
6-pole	
7-pole	
8-pole	
9-pole	
10-pole	
20-pole	
41-poles	
50-pole	
Note	

24			
Type	Qty.	Order No.	
ZQV 2.5N/2 BK	60	2831670000	
ZQV 2.5N/3 BK	60	2831680000	
ZQV 2.5N/4 BK	60	2831690000	
ZQV 2.5N/5 BK	20	2831700000	
ZQV 2.5N/6 BK	20	2831710000	
ZQV 2.5N/7 BK	20	2831720000	
ZQV 2.5N/8 BK	20	2831730000	
ZQV 2.5N/9 BK	20	2831740000	
ZQV 2.5N/10 BK	20	2831750000	
ZQV 2.5N/20 BK	20	2831760000	
ZQV 2.5N/50 BK	5	2831770000	

32			
Type	Qty.	Order No.	
ZQV 4N/2 BK	60	2810840000	
ZQV 4N/3 BK	60	2810880000	
ZQV 4N/4 BK	60	2810890000	
ZQV 4N/5 BK	60	2810900000	
ZQV 4N/6 BK	20	2810910000	
ZQV 4N/7 BK	20	2810920000	
ZQV 4N/8 BK	20	2810930000	
ZQV 4N/9 BK	20	2831780000	
ZQV 4N/10 BK	20	2810830000	
ZQV 4N/20 BK	20	2810870000	
ZQV 4N/41 BK	10	2831890000	



WQV screw-in cross-connection



Any number of poles (extending)

Pre-fitted cross-connections can be set one after the other to produce any required number of poles. To do so, arrange the last and first contact points of two identical WQVs so that they overlap.

- First, remove the fixing screw and screwdriver guide (insulated part) at one of the outer contact points of one of the WQVs.

WQV in combination with a socket contact and test plug

- Remove the fixing screw and insulation part of the WQV. Screw the socket in at this point. This now makes it possible to integrate a safe test point.

Thanks to the many possible ways in which the WQV cross-connection system can be used – break-out of individual layers, creation of any number of poles or running of two voltages parallel to one another – individual modules can be realised very easily!

Technical instructions

- The full rated current of the terminals can be routed across any number of poles.
- No end plates or partition plates needed for adjacent WQV up to 400 V.

Assembly

- Place the WQV in the cross-connection channel in the middle of the terminal and screw tight.
- Individual WQV segments can be broken out by bending over or using the WAW1 tool (9004500000). It is then possible to bridge individual or several terminals.

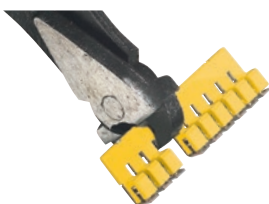

- Captive fixing screws.
- Snap onto the clamped support – simple overhead assembly.



- Then insert the WQV without fixing screw and insulated part. At the same time, insert an unmodified WQV in parallel so as to produce an overlap at the connection. The connection is screwed tight using the fixing screw of the unmodified WQV.

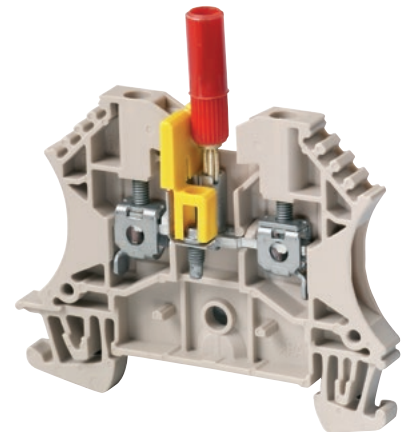

Routing 2 potentials in parallel

- In spite of only having 1 channel, the QV cross-connection system can still be used for offset cross-connections. See the photo “parallel bridging” (see on the next page).

Potential distribution – possible combinations

In one cross-connection channel

single

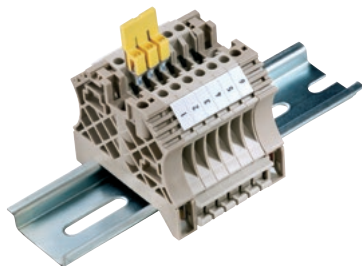

adjacent

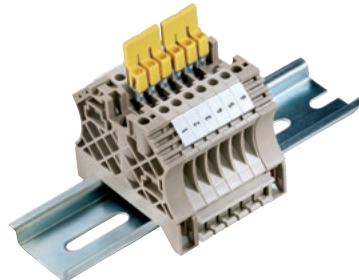

bridging

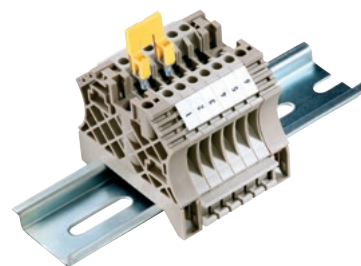

parallel/bridging

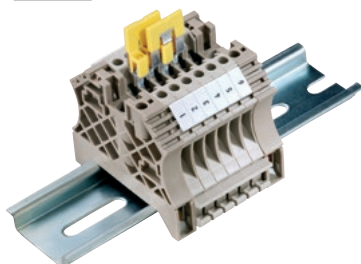

parallel/lengthening



Possible cross-connections of terminals of the same type
with appropriate cross-connectors

Terminal type	Cross-connector	single	adjacent	bridging	parallel bridging	parallel lengthening
Standard						
WDU 1.5/ZZ	WQV 2.5	•	•	•	•	•
WDU 1.5/BLZ	WQV 2.5	•	•	•	•	•
WDU 2.5/1.5/ZR	WQV 2.5	•	•	•	•	•
WDU 2.5 - WDU 35	WQV 2.5 - WQV 35	•	•	•	•	•
WDK 2.5...	WQV 2.5	•	•	•	•	•
WDK 2.5 PE	WQV 2.5	•	•	•	•	•
WDU 2.5/BLZ	WQV 2.5	•	•	•	•	•
WDK 2.5/BLZ	WQV 2.5	•	•	•	•	•
WDU 2.5 F...	WQV 2.5	•	•	•	•	•
WDK 2.5 F...	WQV 2.5	•	•	•	•	•
WDU 4... - WDU 35...	WQV 4 - WQV 35	•	•	•	•	•
WDU 70/95	WQV 70/95	•	•			
WDU 120/150	WQV 120/150	•	•			
WDU 240	WQB 240	•	•			
Compact						
WDU 2.5N	WQV 2.5	•	•	•	•	•
WDU 2.5N 600V	WQV 2.5	•	•	•	•	•
WDU 16N	WQV 16N	•	•	•	•	•
WDU 35N	WQV 35N	•	•			
WDU 50N	WQV 50N	•	•			
WDU 70N	WQV 70N	•	•			
WDU 95N/120N	WQV 95N/120N	•	•			



Screw connection with clamping-yoke technology (W-Series)
Accessories - Potential distribution

Universal range

A

WQV 2.5



Technical data	
Rated current	A
Ordering data	
2-pole	
3-pole	
4-pole	
5-pole	
5-pole	
6-pole	
7-pole	
8-pole	
9-pole	
10-pole	
15-pole	
20-pole	
32-pole	
Note	

32		
Type	Qty.	Order No.
WQV 2.5/2	50	1053660000
WQV 2.5/3	50	1053760000
WQV 2.5/4	50	1053860000
WQV 2.5/5	10	1053960000
WQV 2.5/6	10	1054060000
WQV 2.5/7	10	1054160000
WQV 2.5/8	10	1054260000
WQV 2.5/9	10	1054360000
WQV 2.5/10	20	1054460000
WQV 2.5/15	10	1059660000
WQV 2.5/20	10	1577570000
WQV 2.5/32	10	1577600000

WQV 4



41		
Type	Qty.	Order No.
WQV 4/2	50	1051960000
WQV 4/3	50	1054560000
WQV 4/4	50	1054660000
WQV 4/5	10	1057860000
WQV 4/6	10	1057160000
WQV 4/7	10	1057260000
WQV 4/10	20	1052060000

WQV 6



57		
Type	Qty.	Order No.
WQV 6/2	50	1052360000
WQV 6/3	50	1054760000
WQV 6/4	50	1054860000
WQV 6/5	50	1062660000
WQV 6/6	50	1062670000
WQV 6/7	50	1062680000
WQV 6/10	20	1052260000

WQV 35N



Technical data	
Rated current	A
Ordering data	
2-pole	
3-pole	
4-pole	
5-pole	
5-pole	
6-pole	
7-pole	
8-pole	
9-pole	
10-pole	
15-pole	
20-pole	
32-pole	
Note	

125		
Type	Qty.	Order No.
WQV 35N/2	20	1079200000
WQV 35N/3	20	1079300000
WQV 35N/4	20	1079400000

WQV 50N



150		
Type	Qty.	Order No.
WQV 50N/2	5	1834060000
WQV 50N/3	5	1834070000
WQV 50N/4	5	1834080000
WQV 50N/5	5	2004960000
WQV 50N/5/3/1	5	1469080000

WQV 70N



192		
Type	Qty.	Order No.
WQV 70N/2	5	9512240000
WQV 70N/3	5	9512250000
WQV 70N/4	5	9531290000
WQV 70N/5/3/1	5	1393020000

Screw connection with clamping-yoke technology (W-Series)
Accessories - Potential supply

Universal range

A

Screwable QV

Q AKZ 4 SS



Technical data	
Rated current	A
Ordering data	
2-pole	
3-pole	
4-pole	
10-pole	
20-pole	
Note	

32		
Type	Qty.	Order No.
Q 2 AKZ4SS	50	0369000000
Q 10 AKZ4SS	20	0369300000

Q / DLI



24		
Type	Qty.	Order No.
Q 2 DLI	50	1312500000
Q 3 DLI	50	1312600000
Q 4 DLI	50	1312700000
Q 10 DLI	20	1313100000
Q 20 DLI	20	1399800000

Q AKZ 1.5



24		
Type	Qty.	Order No.
Q 2 AKZ1.5	50	0368200000
Q 3 AKZ1.5	50	0368300000
Q 4 AKZ1.5	50	0368400000
Q 10 AKZ1.5	20	0368500000

Screwable QV

Q AKZ 4



Technical data	
Rated current	A
Ordering data	
2-pole	
3-pole	
4-pole	
10-pole	
20-pole	
Note	

24		
Type	Qty.	Order No.
Q 2 AKZ4	50	0336400000
Q 3 AKZ4	50	0336500000
Q 4 AKZ4	50	0336600000
Q 10 AKZ4	20	0368600000

Q / WDL



24		
Type	Qty.	Order No.
Q 2 WDL2.5S	50	1071500000
Q 3 WDL2.5S	50	1071600000
Q 4 WDL2.5S	50	1071700000
Q 10 WDL2.5S	20	1071800000
Q 20 WDL2.5S	20	1074200000

Potential supply with cross-section reduction

Feed-in via output terminal

WDU 35

onto WDU 10



Technical data	
Rated current	A
Tightening torque	-
Ordering data	
	2-pole
	3-pole
	6-pole
Note	

to WDU 35		to WDU 10	
57		0.6...1.2	
Type	Qty.	Order No.	
WQV 35-10	10	1068000000	
Note			

WDU 35

onto WDU 2.5



to WDU 35		to WDU 2.5	
41		0.4...0.8	
Type	Qty.	Order No.	
WQV 35-2.5	10	1064100000	
Note			

Feed-in via output terminal

WDU 16

WDU 2.5



Technical data	
Rated current	A
Tightening torque	-
Ordering data	
	2-pole
	3-pole
	6-pole
Note	

to WDU 16		to WDU 2.5	
76			
Type	Qty.	Order No.	
WQV 16-2.5	10	1063900000	
Note			

WDU 16N

WDU 2.5



to WDU 16		to WDU 2.5	
76			
Type	Qty.	Order No.	
WQV 16N-2.5	10	1073100000	
Note			

WDU 16N

WDU 4 / WDU 6



to WDU 16N		to WDU 4 / 6	
57			
Type	Qty.	Order No.	
WQV 16N-4/6	10	1072500000	
Note			

Feed-in via output terminal

WDU 10

WDU 2.5



Technical data	
Rated current	A
Tightening torque	-
Ordering data	
	2-pole
	3-pole
	6-pole
Note	

to WDU 10		to WDU 2.5	
57			
Type	Qty.	Order No.	
Q WDU10-2.5 SET	10	1859620000	
Note			

WDU 6

WDU 2.5



to WDU 6		to WDU 2.5	
41			
Type	Qty.	Order No.	
Q WDU6-2.5 SET	10	1859600000	
Note			

Note

Cross-connectors reducing the cross-section may not be used in ATEX applications.

Screw connection with clamping-yoke technology (W-Series)
 Accessories - Potential supply

Universal range

A

Feed-in via output terminal

WDU 10

WDU 4



to WDU 10		to WDU 4	
Rated current	A	32	
Tightening torque	-		
Type	Qty.	Order No.	
Q WDU10-4 SET	10	1859610000	

WDU 35

WDU 4 / WDU 6



to WDU 35		to WDU 4 / 6	
Rated current	A	41	
Tightening torque	-	0.5...1	
Type	Qty.	Order No.	
WQV 35-4/6	10	1064200000	

WDU 16

WDU 4 / WDU 6



to WDU 16		to WDU 4 / 6	
Rated current	A	76	
Tightening torque	-		
Type	Qty.	Order No.	
WQV 16-4/6	10	1064000000	

Technical data	
Rated current	A
Tightening torque	-
Ordering data	
	2-pole
	3-pole
	6-pole
Note	





Screw connection with clamping-yoke technology (W-Series)
Accessories - Testing / checking

Universal range

A

Test adapter

WTA 1



Dimensions	
Width / Length / Height	mm
Stripping length	mm
Rated data	
Rated voltage	V
Rated current	A
for wire cross-section	mm ²
Clamped conductors (H05V/H07V)	
Solid / Stranded	mm ²
Flexible / Flexible with ferrule	mm ²
Ordering data	
1-pole	
with snap-in pegs	
10-pole	
Note	

5 / / 66.1			
6			
IEC	UL	CSA	
250	0		
6	0		
1.5	LEER		
Type	Qty.	Order No.	
WTA 1 WDU1.5	25	1632290000	
WTA 1/ZA WDU1.5	25	1632300000	

WTA 2



5 / / 66.1			
6			
IEC	UL	CSA	
250	0		
6	0		
1.5	LEER		
Type	Qty.	Order No.	
WTA 2 WDU2.5-10	25	1632320000	
WTA 2/ZA WDU2.5-10	25	1632330000	
WTA 2/10 WDU2.5/10	5	1632340000	

WTA 3



6 / / 66.1			
6			
IEC	UL	CSA	
250	0		
6	0		
1.5	LEER		
Type	Qty.	Order No.	
WTA 3 WDU4	25	1632350000	
WTA 3/ZA WDU4	25	1632360000	

Test adapter

WTA 6



Dimensions	
Width / Length / Height	mm
Stripping length	mm
Rated data	
Rated voltage	V
Rated current	A
for wire cross-section	mm ²
Clamped conductors (H05V/H07V)	
Solid / Stranded	mm ²
Flexible / Flexible with ferrule	mm ²
Ordering data	
1-pole	
with snap-in pegs	
10-pole	
Note	

5 / / 66.1			
6			
IEC	UL	CSA	
250	0		
6	0		
1.5	LEER		
Type	Qty.	Order No.	
WTA 6 WTR2.5	25	1632380000	
WTA 6/ZA WTR2.5	25	1632390000	

WTA 7



6 / / 68.15			
6			
IEC	UL	CSA	
250	0		
6	0		
1.5	LEER		
Type	Qty.	Order No.	
WTA 7 WSI6	25	1650210000	

WTA 4N



5 / 55		
6		
IEC	UL	CSA
250	0	
6	0	
1.5	LEER	
0.5...1.5		
1...1.5		
Type	Qty.	Order No.
WTA 4N WDK 2.5	25	1878660000
WTA 4N/ZA WDK 2.5	25	1879350000

WTA 5



5 / 17		
8		
IEC	UL	CSA
250	0	
6	0	
0.75	LEER	
0.5...1		
1...1		
Type	Qty.	Order No.
WTA 5/1	25	1051260000
WTA 5/10	5	1062060000

Test adapter

Dimensions	
Width / Length / Height	mm
Stripping length	-
Rated data	
Rated voltage	V
Rated current	A
for wire cross-section	mm ²
Clamped conductors (H05V/H07V)	
Solid / Stranded	mm ²
Flexible / Flexible with ferrule	-
Ordering data	
	beige
	green
Note	

WTA 8



6 / 39		
IEC	UL	CSA
205	0	
6	0	
1.5	LEER	
0.5...2.5		
Type	Qty.	Order No.
WTA 8 TN	25	1915450000
WTA 8 KO-TN	25	1915480000



Screw connection with clamping yoke technology (W-Series)
Accessories – Specific functions and variations

SIHA fuse holder

For 5x20 G-fuse cartridges

The SIHA fuse holder turns a test disconnect terminal into a fuse terminal in seconds: Simply remove the isolating lever and insert the fuse plug

- Simple handling – no tools required
- Housing made of Wemid (VO)
- Rated current 6.3 A
- 1.6 W power loss to DIN VDE 0611-6 at 23 °C ambient temperature (also for 1.5 times rated current – composite arrangement)
- Even fits on 5 mm wide terminals when fitted in offset arrangement



- Marking position for Dekafix 5 and space for self-adhesive label size 8/20



1. Open fuse holder with fingers or screwdriver.

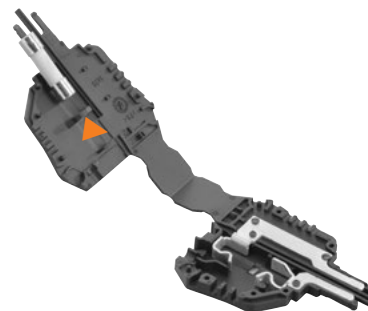

2. Press out old fuse.

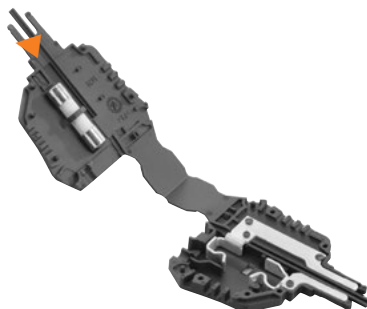

3. Position new fuse.



4. Press fuse holder together again with fingers or screwdriver.

SIHA 1



without LED		Qty.	Order No.
SIHA1/G20	400 V	1	9537550000
with LED (rot)			
SIHA1/G20	10 - 36 V	1	9537560000

For test-disconnect terminal versions

WTR 2,5/ZZ

SIHA 3



without LED		Qty.	Order No.
SIHA3/G20	400 V	1	7921560000
with LED (rot)			
SIHA3/G20	10 - 36 V	1	7921570000
	35 - 70 V	1	7921580000
	60 - 150 V	1	7921590000
	140 - 250 V	1	7921600000

For test-disconnect terminal versions

WTR 4
 WTR 4/ZZ
 WTR 4/ZR
 WTR 2,5

SIHA STRAP

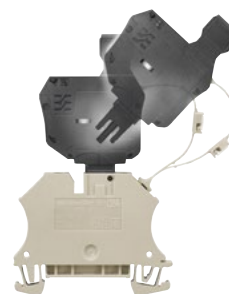

with strap		Qty.	Order No.
SIHA STRAP		20	9537680000

Connector for "retro-fit" assembly

- Receptacle in the terminal is the marking position
- Integrated marking position on the strap
- Slots into fuse holder either left or right

PEN bridges

Energy distribution for machines or in buildings usually consists of 5-conductor systems (TN-S). By contrast, energy supply mains are frequently rated as 4-conductor connection. A PEN bridge joins separate PE and N conductors into one PEN conductor, creating the transition from a TN-S to a TN-C system.

Standard installation

Depending on the terminal type, inside or outside, PEN bridges are available for both PE and N conductor terminals from 10 mm². **Important!** For outside bridges, please note that in this context only the next smaller rated cross-section (than standard) can be connected.

Building installation with N-conductor isolation

Special external cross-connections (WQB-PEN) are available for neutral conductor test-disconnect terminals (WNT). These establish contact between the NT and PE terminals. This results in an earthed neutral conductor with protection function in three-phase systems.

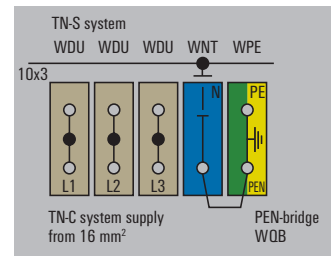

External PEN bridge



WQB-PEN ...

Type	Qty	Order No.	For terminal
with standard terminals			
WQB-PEN 10	10	1060300000	WPE 10 WDU 10 BL
WQB-PEN 16	10	1060200000	WPE 16 WDU 16 BL
WQB-PEN 35	10	1060100000	WPE 35 WDU 35 BL
with compact terminals			
WQB-PEN 16N	10	1079600000	WNT 16N WPE 16N
WQB-PEN 35N	10	1079500000	WNT 35N WPE 35N
WQB-PEN 70N	10	1079700000	WNT 70N WPE 70N

Inside PEN bridge

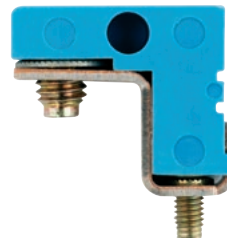

WQV ... -PEN

Typ	Qty	Order No.	For terminal
WQV 16N-PEN	10	1071360000	WPE 16N WDU 16N BL
WQV 70N-PEN	5	9525840000	WPE 70N WDU 70N BL
WQV 70/95-PEN	5	1072300000	WPE 70/95 WDU 70/95 BL
WQV 120-PEN	5	1072400000	WPE 120/150 WDU 120/150 BL
WQV 50N-PEN		9201610000	WPE 50N WDU 50N
WQV 95N/120N-PEN		9201630000	WPE 95N/120N WDU 95N/120N

TN-S system:

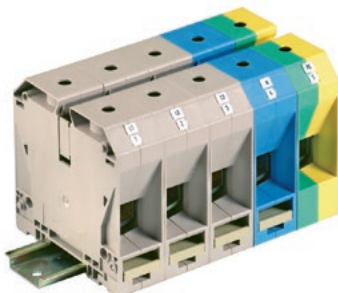
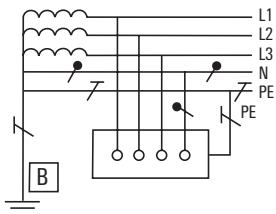

TN-C system:

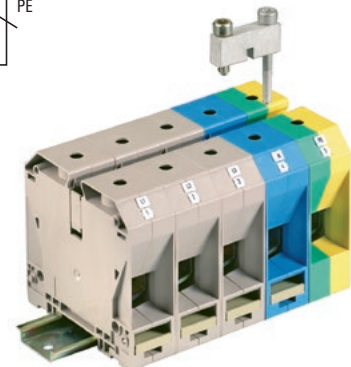
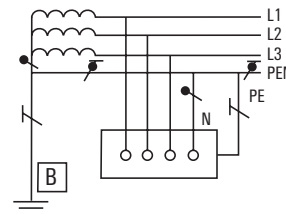

Robust connection for harsh conditions

Klippon® Connect offers maintenance-free contacts using stud technology

Whether it is the supply of high power levels to engines, quick and safe coupling of carriages, energy distribution in the carriages and parts thereof, traffic engineering in general, and high-speed trains especially, all pose real challenges for connectivity. For reliable power transfer in these challenging conditions, we offer series WF, WFF and ST 400 stud terminals. With crimped cable lugs, the conductors are laid on the threaded pins and securely connected together by tightening the hex nut to the required torque. The robust processing guarantees the ultimate in safety.



Our promise

Our stud terminals are an established, robust connection alternative for particularly harsh environments. The extensive accessories and quality workmanship ensure high productivity in planning and installation – and sustainable safety in operation.

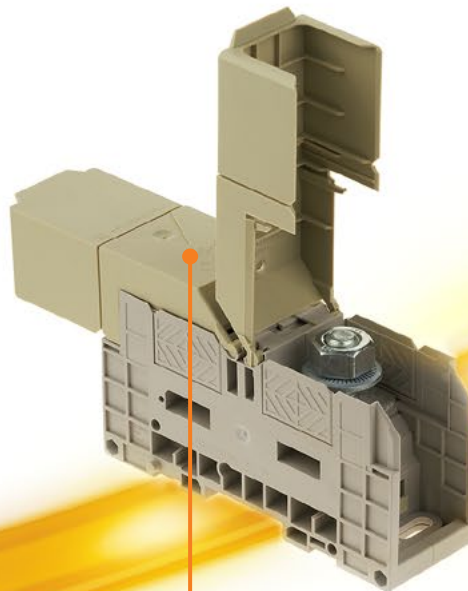

Safety

- Safe operation is guaranteed thanks to cover profiles or the snap-on and screwable hinged hoods
- All materials comply with the fire safety regulations found in DIN EN 45545
- All stud terminals are tested in line with the railway standards and made of self-extinguishing material

**Time saving**

- Extensive accessories
- Quick installation

Flexibility

- Designed for voltage ranges up to 4,000 V and currents up to 415 A
- Simple to use: all that is required is one torque wrench
- Extensive portfolio of one and two stud terminals

Space saving

- Up to two cable lugs can be connected for each stud

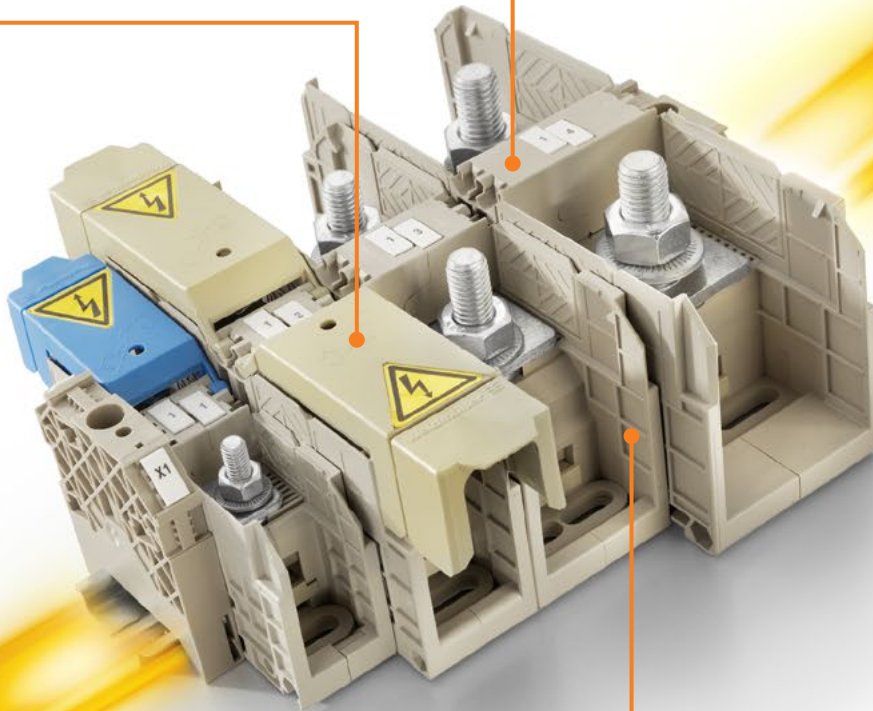
**Overview**

In all applications where reliable power transfer is key, our stud terminals are the safe solution.

Clever operating concept:

The WF and WFF stud terminal series are available as single and two-stud terminals. The option of a built-in folding hinged hood gives the two-stud terminals in the WFF-Series a particularly high level of safety.

Robust and high performance:

The ST 400 stud terminals, made of glass-fibre reinforced, flame resistant artificial resin for operating voltages of up to 4 kV, are specially designed for use on rail vehicles and tested to meet railway standards. They are perfect for applications with high requirements in terms of vibration and shock resistance.



Connect ring lugs quickly and safely

Klippon® Connect SRL Range with stud technology

Our SRL terminals are best suited for applications where connections are subjected to strong vibrations. The wire to be connected is first crimped onto a ring or fork eyelet and then attached to the busbar of the terminal block. The fixing nuts remain captive in the hinged plastic carrier. For connection, the plastic carrier is lifted, the conductor is inserted with the eyelet, and the plastic carrier returned to its initial position. The fixing nut is tightened with a simple screwdriver to create a secure connection between terminal block and eyelet.

Your special advantages:

- All terminal blocks of the SRL family are protected to IP20
- The finger-safe construction makes additional covers unnecessary
- Two cable lugs can also be connected without compromising safety
- SRL 4 STB terminals have hexagon socket screws to accept standard (D) 4.3 mm test adapters
- The variants SRL 3 and SRL 6 are additionally available with internal and external cross-connection options

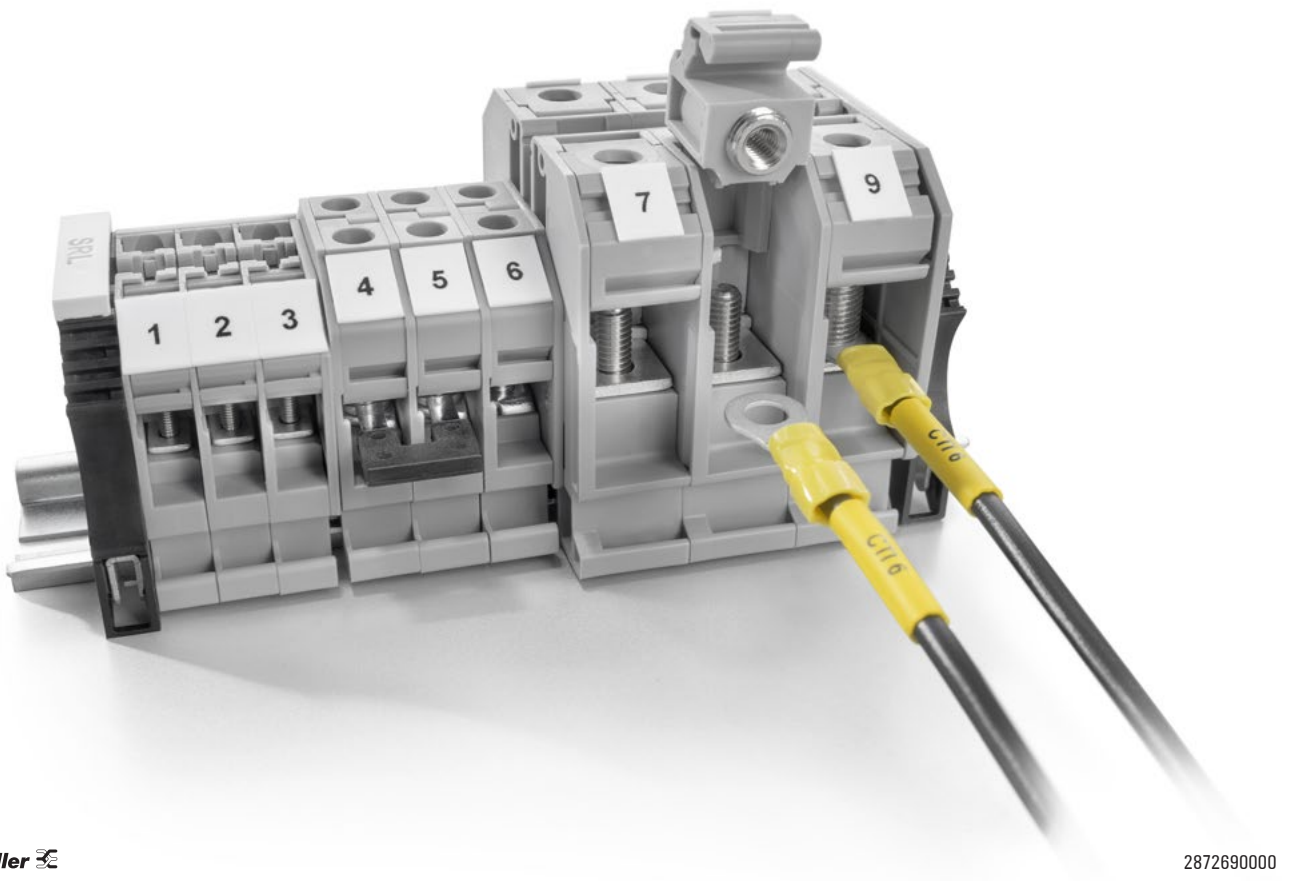

Screw connection with stud technology
Feed-through terminal blocks - SRL

Universal range

A

SRL 4 STB

6 mm²

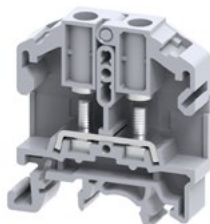

SRL 6

35 mm²

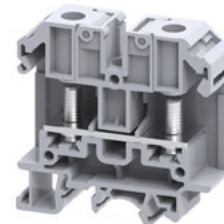

Width/Height/Depth	mm
max. current / Clamping range, max.	A
Max. clamping range	mm ²

11 x 48.5 x 52.2	
/ 41 / 6.00	
1.5...6.00	

18 x 63.9 x	
/ 125 / 35.00	
1.5...35.00	

Technical data

Rated data with Wemid partition wall	
Rated voltage	-
Rated current	A
for wire cross-section	mm ²
Rated impulse withstand voltage / Pollution severity	
Gauge to IEC 60947-1 / UL 94 flammability rating	
Approvals	
Clamped cable lugs	
Cable lug to DIN 46234	
2 x cable lugs DIN 46 234	
Cable lug to DIN 46235	
2 x cable lugs DIN 46 235	
Tightening torque, max.	

IEC 60947-7-1			
IEC	UL	CSA	EN 60079-7
1000			
41			
6			
		8 kV / 3	
CE			
1.5...6 mm ²			
1.5...6 mm ²			
1.5...6 mm ²			
1.5...6 mm ²			
0.5 Nm			

IEC 60947-7-1			
IEC	UL	CSA	EN 60079-7
1000	600		
125	115		
35	AWG 22...2		
		8 kV / 3	
UL			
1.5...35 mm ²			
1.5...35 mm ²			
1.5...35 mm ²			
1.5...35 mm ²			
3 Nm			

Note

Ordering data

Version	
	dark beige
Note	

Type	Qty.	Order No.
SRL 4 STB	50	2614950000

Type	Qty.	Order No.
SRL 6	50	2614960000

Accessories

Plug-in cross-connection	
2-pole	
3-pole	
4-pole	
2-pole	
4-pole	
Cross-connection permanent	
2-pole	
3-pole	
4-pole	
Screwable cross-connection	
2-pole	
3-pole	
4-pole	
10-pole	
End plate	
	dark beige
Marking tags	

Type	Qty.	Order No.
SRQB 4/2	41 A 100	2615220000
SRQB 4/3	41 A 50	2615230000
SRQB 4/4	41 A 50	2615240000
SQS 4/2	41 A 20	2615250000
SQS 4/4	41 A 10	2615260000
SQB 4/2	41 A 100	2615140000
SQB 4/3	41 A 50	2615150000
SQB 4/4	41 A 50	2615160000
SEP SRL 4	50	2615000000
WS 12/9.5-11 MC NE WS	300	2484220000

Type	Qty.	Order No.
SQV 6/2	125 A 100	2615080000
SQV 6/3	125 A 50	2615090000
SQV 6/4	125 A 50	2615100000
SEP SRL 6	50	2615010000
WS 10/15 MC NE WS	240	1854090000

For detailed information on other accessories and application in the online catalogue



Stud terminals

Power transmission

The comprehensive range of stud terminals ensures secure connections for all power transmission applications. Connections range from 10 mm² to 300 mm².

The connectors are attached to the threaded pins using crimped cable lugs and each connection is secured by tightening the hexagon nut. Stud terminals with threaded pins from M5 to M16 can be used according to the wire cross-section.

All stud terminals are tested to international standards (**EN 60947-7-1, EN 50124-1, DIN EN 61373, EN 50343, DIN EN 45545-2, NFF 61-017**) and satisfy the requirements contained therein.

Handling

Cable lugs are crimped onto the cable lugs to connect the connectors. The cable lugs are placed between the washer on the clamp support and the lock washer on the bolt of the WF terminal. With the WFF stud terminals, the cable lugs contact directly to the current bar. Tightening the hexagon nut causes the cable lugs' flaps to press against one another – thereby creating a secure contact.

WF / WFF series

- For voltage ranges up to 1000 V
- For use with special epoxy resin partition plates even up to 2,300 V and 520 A

WF single-stud terminals

- Four connectors can be securely connected without a problem
- Three connectors even without compromising the rated data

WFF two-bolt terminals

- Two connectors can be reliably connected

Accessories

We offer an extensive range of accessories for our stud terminals. A detailed description is available on the accessory overview pages.

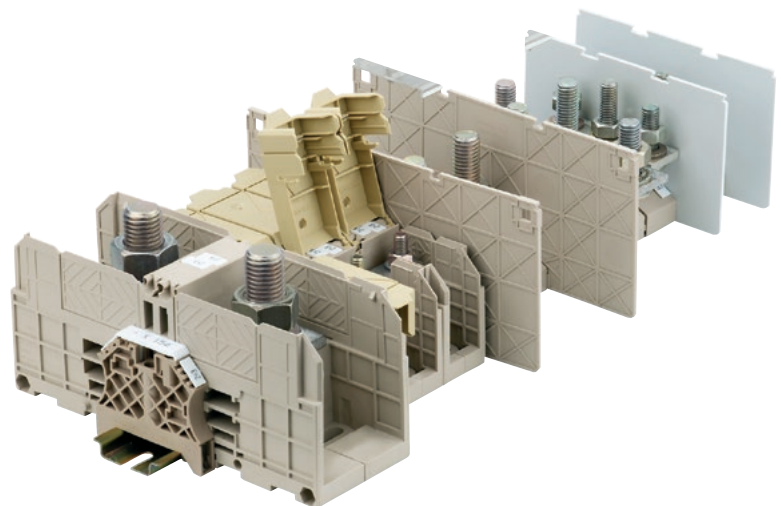

product overview

size of thread	M5	M6	M8	M10	M12	M16
single-stud terminals - WF	•	•	•	•	•	
twin-stud terminals - WF 2 BZ		•	•	•		
twin-stud terminals - WFF		•	•	•	•	•
twin-stud terminals - ST 4000 (up to 4000 V)			•	•	•	

Stud connection

- Stud size M5 to M16
- Connector with cable lug according to DIN 46234 up to 240 mm² and DIN 46235 up to 300 mm²



Cross-connections

- Saves a great deal of time through fast potential distribution
- Can be used for all stud terminals
- 2, 3 and 4-pin variations available
- Potential distribution between different sizes possible (from WF6 to WF8 and to WF10)



Simple operation

- The cable lugs are placed on the bolt using the washer
- The lock washer is placed on top
- A secure contact is established between the cable lugs by tightening the steel nuts

Clamp supports made of Wemid

- Non-tracking CTI 600
- Temperature-resistant up to 130°C
- Self-extinguishing V0 according to UL94
- Non-toxic
- No smoke emission in the event of fire
- Complies with the requirements set out in DIN EN 45545-2

Contact security

- Maintenance-free, no tightening of the nut necessary
- Resistant to vibrations and high contact force through lock washer

Safe operation

Touch-safe protection

- In the case of WF, through partition plates and transparent cover profiles
- In the case of WFF, with a lockable cover hood for each connection

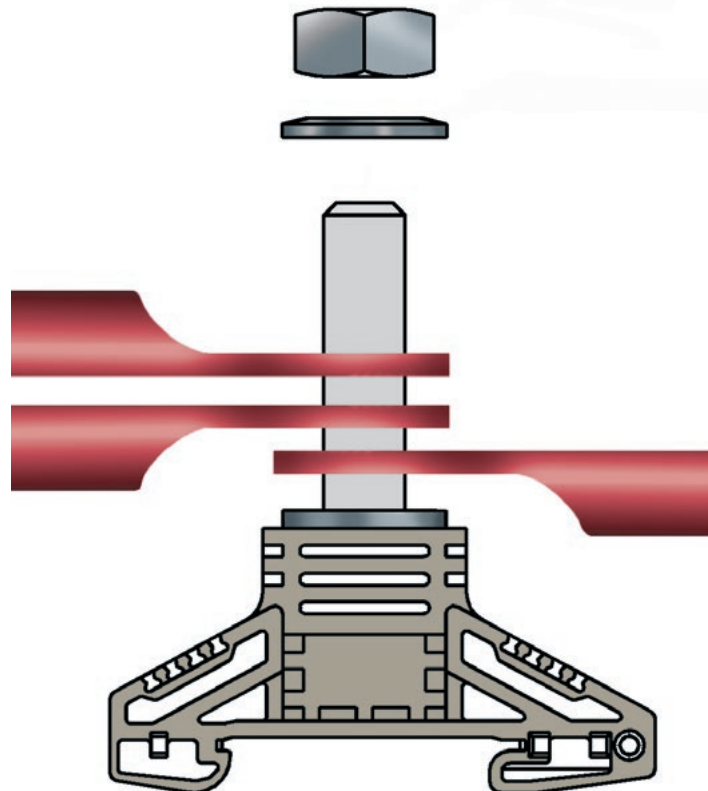

Screw connection with stud technology
Feed-through terminal blocks - WF and WFF

Universal range

A

WF 5 **16 mm²**

Screw thread M5



WF 5 NFF **16 mm²**

Screw thread M5



Width/Height/Depth	mm
max. current / max. cond. cross-section	A
Max. clamping range	mm ²

13 x 67 x 54.5	
76 / 16	
0.1...16	

13 x 67 x 54.5	
76 / 16	
0.1...16	

Technical data

Rated data with Wemid partition wall	
Rated voltage	V
Rated current	A
for wire cross-section	mm ²
Rated impulse withstand voltage / Pollution severity	
Gauge to IEC 60947-1 / UL 94 flammability rating	
Approvals	

Clamped cable lugs	
Cable lug to DIN 46234	
2 x cable lugs DIN 46 234	
Cable lug to DIN 46235	
2 x cable lugs DIN 46 235	
Tightening torque min./max.	

Note

IEC	UL	CSA	EN 60079-7
1000	1000	1000	
76	85	85	
16	AWG 10...4	AWG 10...4	
8 kV / 3			
/ V-0			

CE ENEC	
0.1...16 mm ²	
0.1 to 16 mm ²	
6...10 mm ²	
6...10 mm ²	
2...4 Nm	

1000V UL and CSA for usage groups B and C can be used with isolating terminal rails and when using WTW WF6 1781220000 partitions.

IEC	UL	CSA	EN 60079-7
1000			
76			
16			
8 kV / 3			
/ V-0			

CE ENEC	
0.1...16 mm ²	
0.1 to 16 mm ²	
6...10 mm ²	
6...10 mm ²	
3.7...4.5 Nm	

Ordering data

Version	
	dark beige

Note

Type	Qty.	Order No.
WF 5	25	1790130000

1000 V DC rated voltage passed with the WTW WF6 1781220000 partition plate.

Type	Qty.	Order No.
WF 5 NFF	25	1968990000

Accessories

Cross-connector	
	2-pole
	3-pole
	4-pole

Auxiliary/control connection	
	up to 4 mm ² , 32 A

Spacer	
	dark beige
	Beige epoxy resin
	dark beige

End bracket	
	dark beige

Hood transparent	
	Hood transparent 1000 mm

Holder for shrouding cover transparent	
	Holder for shrouding cover, transparent

Busbar	

Marking tags	

Type	Qty.	Order No.
WQL 2 WF5	76 A 5	1812710000
WQL 3 WF5	76 A 5	1812740000

WTW WF6	

WTW WF6	20	1781220000
WTW WF6 2300	20	1781230000
WTW WF6-WF12	20	1781240000

WEW 35/2	50	1061200000
----------	----	-------------------

ADP WF6/WF8	1	1780930000
-------------	---	-------------------

HA ADP WF6/WF10	10	1781050000
-----------------	----	-------------------

--	--	--

WS 12/5 MC NE WS	720	1609860000
------------------	-----	-------------------

Type	Qty.	Order No.
WQL 2 WF5	76 A 5	1812710000
WQL 3 WF5	76 A 5	1812740000

WTW WF6	

WTW WF6	20	1781220000
WTW WF6 2300	20	1781230000
WTW WF6-WF12	20	1781240000

WEW 35/2	50	1061200000
----------	----	-------------------

ADP WF6/WF8	1	1780930000
-------------	---	-------------------

HA ADP WF6/WF10	10	1781050000
-----------------	----	-------------------

--	--	--

WS 15/5 MC NE WS	480	1609880000
DEK 5/6 MC NE WS	1000	1609820000

For detailed information on other accessories and application in the online catalogue

With WTW...2300 made from epoxy resin, rated current is 2300 V according to DIN EN 50124-1

With WTW...2300 made from epoxy resin, rated current is 2300 V according to DIN EN 50124-1

WF 6

35 mm²

Screw thread M6



17.8 x 67 x 54.5
125 / 35
2.5...35



IEC	UL	CSA	EN 60079-7
1000	1000	1000	
125	115	150	
35	AWG 14...2	AWG 14...2	
8 kV / 3 / V-0			



2.5...35 mm²
2.5 to 35 mm²
6...25 mm²
6...25 mm²
3...6 Nm

1000 V UL and CSA for usage groups B and C; can be used with isolating terminal rails and when using WTW-type partitions.

Type	Qty.	Order No.
WF 6	25	1780850000
1000 VDC rated voltage tested.		

Type	Qty.	Order No.
WQL 2 WF6	125 A 5	1780970000
WQL 3 WF6	125 A 5	1780980000
WZAF 35	32 A 10	1070500000
WTW WF6	20	1781220000
WTW WF6 2300	20	1781230000
WTW WF6-WF12	20	1781240000
WEW 35/2	50	1061200000
ADP WF6/WF8	1	1780930000
HA ADP WF6/WF10	10	1781050000
WS 10/6 MC NE WS	600	1828450000

With WTW...2300 made from epoxy resin, rated current is 2300 V according to DIN EN 50124-1

WF 6 NFF

35 mm²

Screw thread M6



17.8 x 67 x 54.5
125 / 35
2.5...35



IEC	UL	CSA	EN 60079-7
1000			
125			
35			
8 kV / 3 / V-0			



2.5...35 mm²
2.5 to 35 mm²
6...35 mm²
6...25 mm²
5.8...7 Nm

Type	Qty.	Order No.
WF 6 NFF	25	1969000000

Type	Qty.	Order No.
WQL 2 WF6	125 A 5	1780970000
WQL 3 WF6	125 A 5	1780980000
WZAF 35	32 A 10	1070500000
WTW WF6	20	1781220000
WTW WF6 2300	20	1781230000
WTW WF6-WF12	20	1781240000
WEW 35/2	50	1061200000
ADP WF6/WF8	1	1780930000
HA ADP WF6/WF10	10	1781050000
WS 15/5 MC NE WS	480	1609880000
DEK 5/6 MC NE WS	1000	1609820000

With WTW...2300 made from epoxy resin, rated current is 2300 V according to DIN EN 50124-1

WF 8

50 mm²

Screw thread M8



22.8 x 67 x 63.5
150 / 50
2.5...50



IEC	UL	CSA	EN 60079-7
1000		1000	
150		200	
50	AWG 14...0	AWG 14...0	
8 kV / 3 / V-0			



2.5...50 mm²
2.5 to 50 mm²
6...35 mm²
6...35 mm²
6...12 Nm

1000 V UL and CSA for use groups B and C; can be used with isolating DIN rails and when using WTW-type partitions.

Type	Qty.	Order No.
WF 8	25	1780860000

Type	Qty.	Order No.
WQL 2 WF8	150 A 5	1780990000
WQL 3 WF8	150 A 5	1781000000
WZAF 70	32 A 10	1066200000
WTW WF8	20	1780900000
WTW WF8 2300	20	1780910000
WEW 35/2	50	1061200000
ADP WF6/WF8	1	1780930000
HA ADP WF6/WF10	10	1781050000
WS 10/6 MC NE WS	600	1828450000

With WTW...2300 made from epoxy resin, rated current is 2300 V according to DIN EN 50124-1



Screw connection with stud technology
Feed-through terminal blocks - WF and WFF

WF 8 NFF

50 mm²

Screw thread M8



WF 10

120 mm²

Screw thread M10



Width/Height/Depth	mm
max. current / max. cond. cross-section	A
Max. clamping range	mm ²

22.8 x 67 x 63.5	
150 / 50	
2.5...50	

33.8 x 67 x 72.5	
269 / 120	
6...120	

Technical data

Rated data with Wemid partition wall	
Rated voltage	V
Rated current	A
for wire cross-section	mm ²
Rated impulse withstand voltage / Pollution severity	
Gauge to IEC 60947-1 / UL 94 flammability rating	
Approvals	
Clamped cable lugs	
Cable lug to DIN 46234	
2 x cable lugs DIN 46 234	
Cable lug to DIN 46235	
2 x cable lugs DIN 46 235	
Tightening torque min./max.	

IEC	UL	CSA	EN 60079-7
1000			
150			
50			
		8 kV / 3	
		/V-0	
CE			
2.5...50 mm ²			
2.5 to 50 mm ²			
6...35 mm ²			
6...35 mm ²			
15...18 Nm			

IEC	UL	CSA	EN 60079-7
1000		1000	
269		320	
120	AWG 10...250	AWG 10...250	
		8 kV / 3	
		/V-0	
CE			
6...120 mm ²			
6 to 120 mm ²			
10...95 mm ²			
10...95 mm ²			
10...20 Nm			

1000 V UL and CSA for use groups B and C: can be used with isolating DIN rails and when using WTW-type partitions.

Note

Ordering data

Version	
	dark beige
Note	

Type	Qty.	Order No.
WF 8 NFF	25	1968960000

Type	Qty.	Order No.
WF 10	20	1780870000

Accessories

Cross-connector	
	2-pole
	3-pole
	4-pole
Auxiliary/control connection	
	up to 4 mm ² , 32 A
Spacer	
	dark beige
	Beige epoxy resin
	dark beige
End bracket	
	dark beige
Hood transparent	
	Hood transparent 1000 mm
Holder for shrouding cover transparent	
	Holder for shrouding cover, transparent
Busbar	
Marking tags	

Type	Qty.	Order No.
WQL 2 WF8	150 A 5	1780990000
WQL 3 WF8	150 A 5	1781000000
WZAF 70	32 A 10	1066200000
WTW WF8	20	1780900000
WTW WF8 2300	20	1780910000
WEW 35/2	50	1061200000
ADP WF6/WF8	1	1780930000
HA ADP WF6/WF10	10	1781050000
WS 15/5 MC NE WS	480	1609880000
DEK 5/6 MC NE WS	1000	1609820000

Type	Qty.	Order No.
WQL 2 WF10	269 A 5	1781010000
WQL 3 WF10	269 A 5	1781020000
WQL 4 WF10	265 A 5	1027840000
WZAF 120	32 A 10	1066300000
WTW WF10/WF12	20	1780890000
WTW WF10/WF12 2300	20	1780920000
WEW 35/2	50	1061200000
ADP WF10/WF12	1	1780940000
HA ADP WF6/WF10	10	1781050000
WS 10/6 MC NE WS	600	1828450000

For detailed information on other accessories and application in the online catalogue

With WTW...2300 made from epoxy resin, rated current is 2300 V according to DIN EN 50124-1

With WTW...2300 made from epoxy resin, rated current is 2300 V according to DIN EN 50124-1

WF 10 NFF

120 mm²

Screw thread M10



33.8 x 67 x 72.5
269 / 120
6...120



IEC	UL	CSA	EN 60079-7
1000			
269			
120			
8 kV / 3 / V-0			
CE 000000			
6...120 mm ²			
6 to 120 mm ²			
10...95 mm ²			
10...95 mm ²			
30...36 Nm			

Type	Qty.	Order No.
WF 10 NFF	20	1968950000

Type	Qty.	Order No.
WQL 2 WF10	269 A 5	1781010000
WQL 3 WF10	269 A 5	1781020000
WQL 4 WF10	265 A 5	1027840000
WZAF 120	32 A 10	1066300000
WTW WF10/WF12	20	1780890000
WTW WF10/WF12 2300	20	1780920000
WEW 35/2	50	1061200000
ADP WF10/WF12	1	1780940000
HA ADP WF6/WF10	10	1781050000
SMSE WF10/2XM6	10	1868880000
WS 15/5 MC NE WS	480	1609880000
DEK 5/6 MC NE WS	1000	1609820000

With WTW...2300 made from epoxy resin, rated current is 2300 V according to DIN EN 50124-1

WF 12

120 mm²

Screw thread M12



33.8 x 67 x 70.5
269 / 120
6...120



IEC	UL	CSA	EN 60079-7
1000	1000	1000	
269	255	320	
120	AWG 10...250	AWG 10...250	
8 kV / 3 / V-0			
CE 000000			
6...120 mm ²			
6 to 120 mm ²			
10...95 mm ²			
10...95 mm ²			
14...31 Nm			

1000 V UL and CSA for use groups B and C: can be used with isolating DIN rails and when using WTW-type partitions.

Type	Qty.	Order No.
WF 12	20	1780880000

Type	Qty.	Order No.
WQL 2 WF12	269 A 5	1781030000
WQL 3 WF12	269 A 5	1781040000
WZAF 185	32 A 10	1066400000
WTW WF10/WF12	20	1780890000
WTW WF10/WF12 2300	20	1780920000
WEW 35/2	50	1061200000
ADP WF10/WF12	1	1780940000
HA ADP WF6/WF10	10	1781050000
WS 10/6 MC NE WS	600	1828450000

With WTW...2300 made from epoxy resin, rated current is 2300 V according to DIN EN 50124-1

WF 12 NFF

120 mm²

Screw thread M12



33.8 x 67 x 70.5
269 / 120
6...120



IEC	UL	CSA	EN 60079-7
1000			
269			
120			
8 kV / 3 / V-0			
CE 000000			
6...120 mm ²			
6 to 120 mm ²			
10...95 mm ²			
10...95 mm ²			
50...60 Nm			

Type	Qty.	Order No.
WF 12 NFF	20	1968940000

Type	Qty.	Order No.
WQL 2 WF12	269 A 5	1781030000
WQL 3 WF12	269 A 5	1781040000
WZAF 185	32 A 10	1066400000
WTW WF10/WF12	20	1780890000
WTW WF10/WF12 2300	20	1780920000
WEW 35/2	50	1061200000
ADP WF10/WF12	1	1780940000
HA ADP WF6/WF10	10	1781050000
SMSE WF10/2XM6	10	1868880000
WS 15/5 MC NE WS	480	1609880000
DEK 5/6 MC NE WS	1000	1609820000

With WTW...2300 made from epoxy resin, rated current is 2300 V according to DIN EN 50124-1



Screw connection with stud technology
Feed-through terminal blocks - WF and WFF

Universal range

A

WF 6/2BZ

35 mm²

Screw thread M6

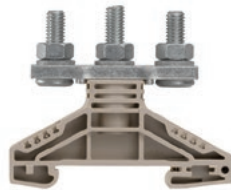

WF 8/2BZ

50 mm²

Screw thread M8



Width/Height/Depth	mm
max. current / max. cond. cross-section	A
Max. clamping range	mm ²

17.8 x 67 x 54.5
125 / 35
2.5...35

22.8 x 67 x 63.5
150 / 50
2.5...50

Technical data

Rated data with Wemid partition wall	
Rated voltage	V
Rated current	A
for wire cross-section	mm ²
Rated impulse withstand voltage / Pollution severity	
Gauge to IEC 60947-1 / UL 94 flammability rating	
Approvals	

Clamped cable lugs

- Cable lug to DIN 46234
- 2 x cable lugs DIN 46 234
- Cable lug to DIN 46235
- 2 x cable lugs DIN 46 235
- Tightening torque min./max.

Note

IEC	UL	CSA	EN 60079-7
1000	1000	1000	
125	115	115	
35			
8 kV / 3			
/ V-0			



- 2.5...35 mm²
- 2.5 to 35 mm²
- 6...25 mm²
- 6...25 mm²
- 3...6 Nm

1000 V UL and CSA for usage groups B and C: can be used with isolating terminal rails and when using WTW-type partitions.

IEC	UL	CSA	EN 60079-7
1000	1000	1000	
150	150	150	
50			
8 kV / 3			
/ V-0			



- 2.5...50 mm²
- 2.5 to 50 mm²
- 6...35 mm²
- 6...35 mm²
- 6...12 Nm

1000 V UL and CSA for usage groups B and C: can be used with isolating terminal rails and when using WTW-type partitions.

Ordering data

Version	
	dark beige
Note	

Type	Qty.	Order No.
WF 6/2BZ	25	1789770000
1000 VDC rated voltage tested.		

Type	Qty.	Order No.
WF 8/2BZ	25	1789780000
1000 VDC rated voltage tested.		

Accessories

Cross-connector	
	2-pole
	3-pole
Auxiliary/control connection	
	up to 4 mm ² , 32 A
Spacer	
	dark beige
	Beige epoxy resin
End bracket	dark beige
Hood transparent	
	Hood transparent 1000 mm
Holder for shrouding cover transparent	
	Holder for shrouding cover, transparent
Marking tags	

Type	Qty.	Order No.
WQL 2 WF6	125 A	5 1780970000
WQL 3 WF6	125 A	5 1780980000
WZAF 35	32 A	10 1070500000
WTW WF10/WF12		20 1780890000
WTW WF6 2300		20 1781230000
WEW 35/2		50 1061200000
ADP WF10/WF12		1 1780940000
HA ADP WF6/WF10		10 1781050000
WS 12/5 MC NE WS		720 1609860000

Type	Qty.	Order No.
WQL 2 WF8	150 A	5 1780990000
WQL 3 WF8	150 A	5 1781000000
WZAF 70	32 A	10 1066200000
WTW WF10/WF12		20 1780890000
WTW WF8 2300		20 1780910000
WEW 35/2		50 1061200000
ADP WF10/WF12		1 1780940000
HA ADP WF6/WF10		10 1781050000
WS 12/5 MC NE WS		720 1609860000

For detailed information on other accessories and application in the online catalogue

With WTW...2300 made from epoxy resin, rated current 2300 V according to DIN EN 50124 pt 1

With WTW...2300 made from epoxy resin, rated current 2300 V according to DIN EN 50124 pt 1

WF 10/2BZ

120 mm²

Screw thread M10



33.8 x 87.6 x 72.5
269 / 120
6...120



IEC	UL	CSA	EN 60079-7
1000	1000	1000	
269	230	230	
120			

8 kV / 3
/ V-0



6...120 mm²
6 to 120 mm²
10...95 mm²
10...95 mm²
10...20 Nm

1000 V UL and CSA for usage groups B and C; can be used with isolating terminal rails and when using WTW-type partitions.

Type	Qty.	Order No.
WF 10/2BZ	10	1789790000

1000 VDC rated voltage tested.

Type	Qty.	Order No.
WQL 2 WF10	269 A 5	1781010000
WQL 3 WF10	269 A 5	1781020000
WZAF 120	32 A 10	1066300000
WTW WF10/WF12	20	1780890000
WTW WF10/WF12 2300	20	1780920000
WEW 35/2	50	1061200000
ADP WF10/WF12	1	1780940000
HA ADP WF6/WF10	10	1781050000

Stud connection series WF

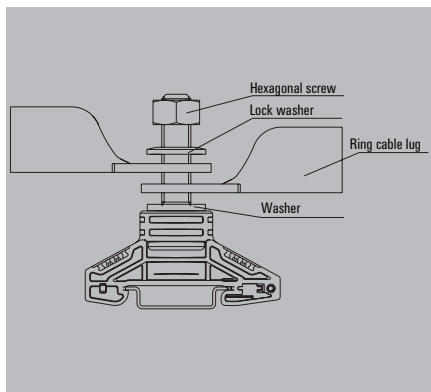

Stud connection series WF NFF

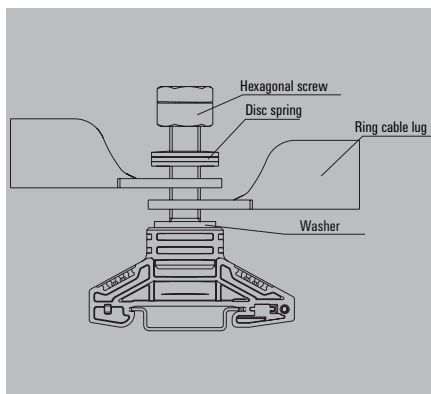

Auxiliary/control line connection WZAF

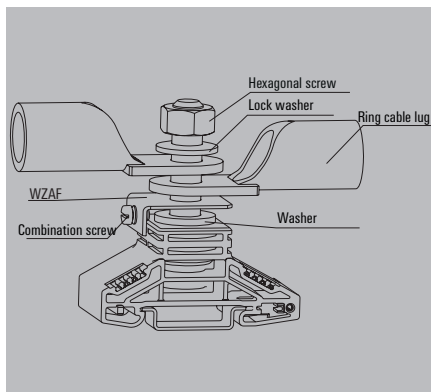

Application example

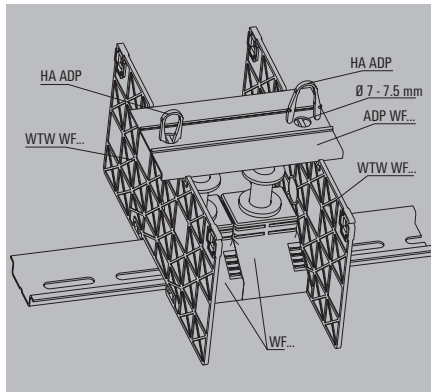

Structure to use cover profiles (ADP WF) on the partition plates (WTW WF) with the relevant holders (HA ADP).

Drilled holes for cover profiles 7-7.5 mm

With WTW...2300 made from epoxy resin, rated current 1500 V up to 70 mm² according to DIN EN 50124 pt 1



Screw connection with stud technology
Feed-through terminal blocks - WF and WFF

Universal range

A

WFF 35

35 mm²

Screw thread M6



Width/Height/Depth	mm
max. current / max. cond. cross-section	A/mm ²
Max. clamping range	mm ²

27 x 107 x 51	
150 / 50	
2.5...50	

Ex eb II
C Gb II 2 G D

Technical data

Rated data with Wemid partition wall	
Rated voltage	V
Rated current	A
for wire cross-section	mm ²
Rated impulse withstand voltage / Pollution severity	
Gauge to IEC 60947-1 / UL 94 flammability rating	
Approvals	
Clamped cable lugs	
Cable lug to DIN 46234 / 2 x cable lugs DIN 46 234	
Cable lug to DIN 46235 / 2 x cable lugs DIN 46 235	
Tightening torque min./max.	
Note	

IEC	UL	CSA	EN 60079-7
1000	1000	600	1100
125	115	130	125
35	AWG 14...2	AWG 14...2	35 mm ²
8 kV / 3			
/ V-0			
KEMA 98ATEX1684 U			
2.5...50 mm ² / 2.5 to 35 mm ²			
6...25 mm ² / 6...25 mm ²			
3...6 Nm			
1000 V UL and CSA for usage groups B and C: can be used with isolating terminal rails and when using WTW-type partitions.			

Ordering data

Version	dark beige
	dark beige
	Blue
Note	

Type	Qty.	Order No.
WFF 35	10	1028300000
WFF 35/AH	5	1029300000
WFF 35 BL	10	1028380000
1000 VDC rated voltage tested.		

Accessories

Cross-connector	2-pole
	3-pole
Auxiliary/control connection	up to 4 mm ² , 32 A
Spacer	dark beige
End bracket	dark beige, screwable
Hood	Hood, dark beige Wemid
Marking tags	Warning triangle for power supply terminals

Type	Qty.	Order No.
WQL 2 WFF35	125 A 5	1064900000
WQL 3 WFF35	125 A 5	1065400000
WZAF 35	32 A 10	1070500000
WTW WFF35	10	1067100000
WEW 35/1	50	1059000000
WAH 35	20	1064460000
WD 1 25 K KARTE A 6 ST	5	1563900000
WS 12/6.5 MC NE WS	540	1609920000

For detailed information on other accessories and application in the online catalogue

WAH 35 in blue, Order no. 1064480000

Technical drawing

Drilling template for direct mounting	
Fixing screw for direct mounting	Order No.
M6 x 16	1063700000

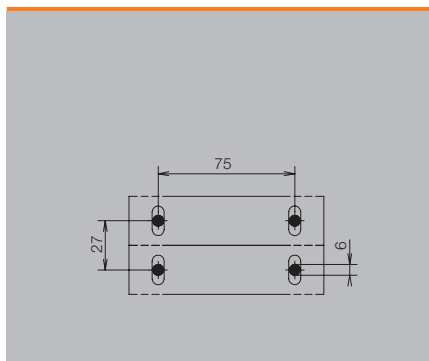

WFF 35 NFF

35 mm²

Screw thread M6



27 x 107 x 51	
125 / 50	
2.5...50	

IEC	UL	CSA	EN 60079-7
500			
125			
35			
8 kV /			
/ V-0			
2.5...50 mm ² / 2.5 to 35 mm ²			
6...25 mm ² / 6...25 mm ²			
5.8...7 Nm			

Type	Qty.	Order No.
WFF 35 NFF	5	1049220000

Type	Qty.	Order No.
WQL 2 WFF35	125 A 5	1064900000
WQL 3 WFF35	125 A 5	1065400000
WZAF 35	32 A 10	1070500000
WTW WFF35	10	1067100000
WEW 35/1	50	1059000000
WAH 35	20	1064460000
WD 1 25 K KARTE A 6 ST	5	1563900000
WS 12/6.5 MC NE WS	540	1609920000

WAH 35 in blue, Order no. 1064480000

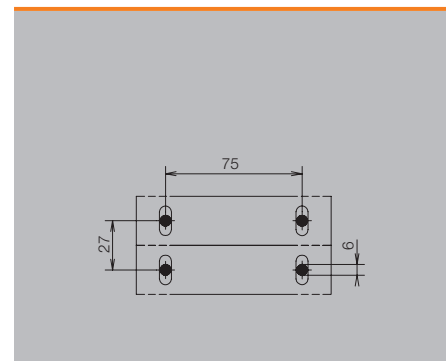

WFF 70

70 mm²

Screw thread M8



31.8 x 132 x 61
232 / 95
2.5...95

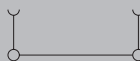

Ex eb II
C Gb II 2 G D

IEC	UL	CSA	EN 60079-7
1000	1000	600	
192	175	170	
70	AWG 14...0	AWG 14...0	

8 kV / 3
/ V-0

KEMA 98ATEX1684 U

2.5...95 mm² / 2.5...70 mm²
16...70 mm² / 16...70 mm²
6...12 Nm

When connecting cable lugs (in accordance with DIN 46234) with 70 and 95 mm², the rated voltage is reduced to 800 V.

Type	Qty.	Order No.
WFF 70	10	1028400000
WFF 70/AH	5	1029400000
WFF 70 BL	10	1028480000

1000 V DC rated voltage tested. 1000 V UL and CSA for usage groups B and C. can be used with isolating terminal rails and when using WTW-type partitions.

Type	Qty.	Order No.
WQL 2 WFF70	192 A 5	1065000000
WQL 3 WFF70	192 A 5	1065500000
WZAF 70	32 A 10	1066200000
WTW WFF70	10	1067200000
WEW 35/1	50	1059000000
WAH 70 BE	20	1064560000
WD 1 25 K KARTE A 6 ST	5	1563900000
WS 12/6.5 MC NE WS	540	1609920000

WAH 70 in blue, Order no. 1064580000

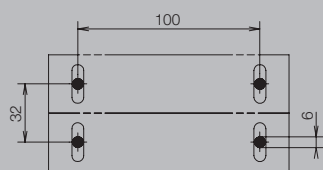

WFF 70 NFF

70 mm²

Screw thread M8

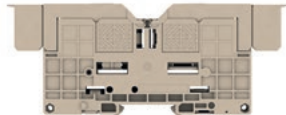

32 x 132 x 61
192 / 95
2.5...95

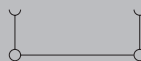

IEC 60947-7-1

IEC	UL	CSA	EN 60079-7
1000			
192			
70			

8 kV /
/ V-0

CE

2.5...95 mm² / 2.5...70 mm²
16...70 mm² / 16...70 mm²
15...18 Nm

Type	Qty.	Order No.
WFF 70 NFF	5	1049230000

Type	Qty.	Order No.
WQL 2 WFF70	192 A 5	1065000000
WQL 3 WFF70	192 A 5	1065500000
WZAF 70	32 A 10	1066200000
WTW WFF70	10	1067200000
WEW 35/1	50	1059000000
WAH 70 BE	20	1064560000
WD 1 25 K KARTE A 6 ST	5	1563900000
WS 12/6.5 MC NE WS	540	1609920000

WAH 70 in blue, Order no. 1064580000

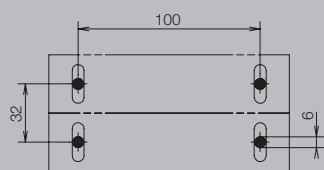

WFF 120

120 mm²

Screw thread M10



42 x 132 x 72
309 / 150
6...150

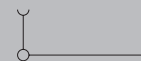

Ex eb II
C Gb II 2 G D

IEC	UL	CSA	EN 60079-7
1000	1000	600	
269	310	310	
120	AWG 10...250	AWG 10...250	

8 kV / 3
/ V-0

KEMA 98ATEX1684 U

6...150 mm² / 6 to 120 mm²
16...150 mm² / 16...120 mm²
10...20 Nm

1000 V UL and CSA for usage groups B and C. can be used with isolating terminal rails and when using WTW-type partitions.

Type	Qty.	Order No.
WFF 120	5	1028500000
WFF 120/AH	4	1029500000
WFF 120 BL	5	1028580000

1000 VDC rated voltage tested.

Type	Qty.	Order No.
WQL 2 WFF120	269 A 5	1065100000
WQL 3 WFF120	269 A 5	1065600000
WZAF 120	32 A 10	1066300000
WTW WFF120	10	1067300000
WEW 35/1	50	1059000000
WAH 120	20	1064660000
WD 1 25 K KARTE A 6 ST	5	1563900000
WS 12/6.5 MC NE WS	540	1609920000

WAH 120 in blue, order No. 1064680000

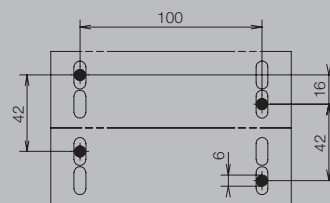

Screw connection with stud technology
Feed-through terminal blocks - WF and WFF

Universal range

A

WFF 120 NFF

120 mm²

Screw thread M10

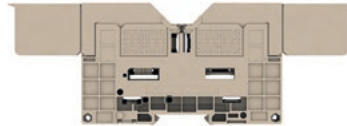

Width/Height/Depth	mm
max. current / max. cond. cross-section	A/mm ²
Max. clamping range	mm ²

42 x 132 x 72.5	
269 / 150	
6...150	

Technical data

Rated data with Wemid partition wall	
Rated voltage	V
Rated current	A
for wire cross-section	mm ²
Rated impulse withstand voltage / Pollution severity	
Gauge to IEC 60947-1 / UL 94 flammability rating	
Approvals	
Clamped cable lugs	
Cable lug to DIN 46234 / 2 x cable lugs DIN 46 234	
Cable lug to DIN 46235 / 2 x cable lugs DIN 46 235	
Tightening torque min./max.	
Note	

IEC	UL	CSA	EN 60079-7
500			
269			
120			
8 kV /			
/ V-0			
CE			
6...150 mm ² / 6 to 120 mm ²			
16...150 mm ² / 16...120 mm ²			
30...36 Nm			
Note			

Ordering data

Version	
	dark beige
	dark beige
	Blue
Note	

Type	Qty.	Order No.
WFF 120 NFF	4	1049240000
Note		

Accessories

Cross-connector	
	2-pole
	3-pole
Auxiliary/control connection	
	up to 4 mm ² , 32 A
Spacer	
	dark beige
End bracket	
	dark beige, screwable
Hood	
	Hood, dark beige Wemid
Marking tags	
	Warning triangle for power supply terminals
For detailed information on other accessories and application in the online catalogue	

Type	Qty.	Order No.
WQL 2 WFF120	269 A 5	1065100000
WQL 3 WFF120	269 A 5	1065600000
WZAF 120	32 A 10	1066300000
WTW WFF120	10	1067300000
WEW 35/1	50	1059000000
WAH 120	20	1064660000
WD 1 25 K KARTE A 6 ST	5	1563900000
WS 12/6.5 MC NE WS	540	1609920000
Note		
WAH 120 in blue, order No. 1064680000		

Technical drawing

Drilling template for direct mounting	
Fixing screw for direct mounting	
M6 x 16	Order No. 1063700000
Note	

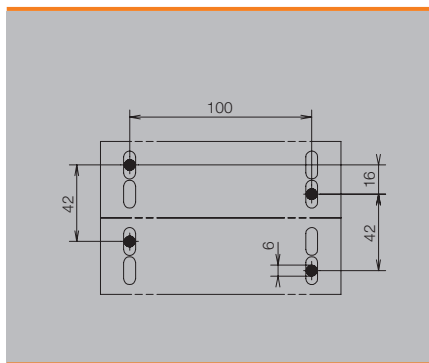

WFF 185

185 mm²

Screw thread M12



55 x 163 x 77.5	
415 / 240	
10...240	

IEC 60947-7-1	UL	CSA	EN 60079-7
1000	1000	600	
353	380	360	
185	AWG 8...500	AWG 8...500	
8 kV / 3			
/ V-0			
CE			
10...240 mm ² / 10...185 mm ²			
25...240 mm ² / 25...185 mm ²			
14...31 Nm			
Note			
1000 V UL and CSA for usage groups B and C: can be used with isolating terminal rails and when using WTW-type partitions.			

Type	Qty.	Order No.
WFF 185	4	1028600000
WFF 185/AH	2	1029600000
WFF 185 BL	4	1028680000
Note		
1000 VDC rated voltage tested.		

Type	Qty.	Order No.
WQL 2 WFF185	353 A 5	1065200000
WQL 3 WFF185	353 A 5	1065700000
WZAF 185	32 A 10	1066400000
WTW WFF185/300	10	1067400000
WEW 35/1	50	1059000000
WAH 185/300 BE	10	1064760000
WD 1 25 K KARTE A 6 ST	5	1563900000
WS 12/6.5 MC NE WS	540	1609920000
Note		
WAH 185/300 in blue, Order no. 1064780000		

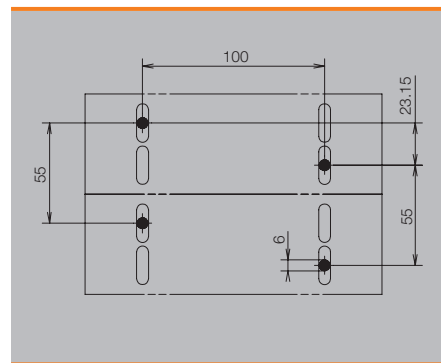

WFF 185 NFF

185 mm²

Screw thread M12



55 x 163 x 77.2
353 / 240
10...240

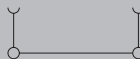

IEC	UL	CSA	EN 60079-7
500			
353			
185			

8 kV /
/V-0

CE

10...240 mm² / 10...185 mm²

25...240 mm² / 25...185 mm²

50...60 Nm

Type	Qty.	Order No.
WFF 185 NFF	2	1049250000

Type	Qty.	Order No.
WQL 2 WFF185	353 A 5	1065200000
WQL 3 WFF185	353 A 5	1065700000
WZAF 185	32 A 10	1066400000
WTW WFF185/300	10	1067400000
WEW 35/1	50	1059000000
WAH 185/300 BE	10	1064760000
WD 1 25 K KARTE A 6 ST	5	1563900000
WS 12/6.5 MC NE WS	540	1609920000

WAH 185/300 in blue, Order no. 1064780000

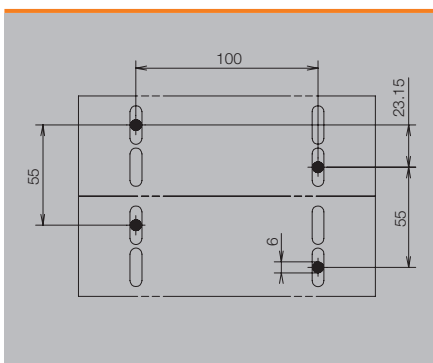

WFF 300

300 mm²

Screw thread M16



55 x 163 x 85.5
520 / 300
25...300

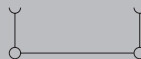

Ex eb II
C Gb II 2 G D

IEC	UL	CSA	EN 60079-7
1000	1000	600	
520	500	510	
300	AWG 6...600	AWG 6...600	

8 kV /
/V-0

KEMA 98ATEX1684 U

25...240 mm² / 25 to 240 mm²

50...300 mm² / 50...300 mm²

25...60 Nm

1000 V UL and CSA for usage groups B and C: can be used with isolating terminal rails and when using WTW-type partitions.

Type	Qty.	Order No.
WFF 300	4	1028700000
WFF 300/AH	2	1029700000

1000 VDC rated voltage tested.

Type	Qty.	Order No.
WQL 2 WFF300	520 A 5	1065300000
WQL 3 WFF300	520 A 5	1065800000
WZAF 300	32 A 10	1066500000
WTW WFF185/300	10	1067400000
WEW 35/1	50	1059000000
WAH 185/300 BE	10	1064760000
WD 1 25 K KARTE A 6 ST	5	1563900000
WS 12/6.5 MC NE WS	540	1609920000

WAH 185/300 in blue, Order no. 1064780000

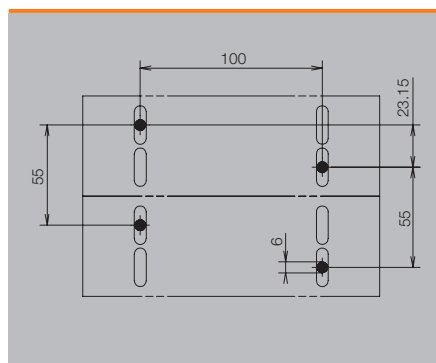

Stud connection series WFF

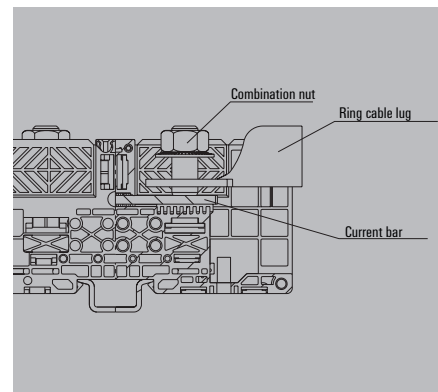

Stud connection series WFF NFF

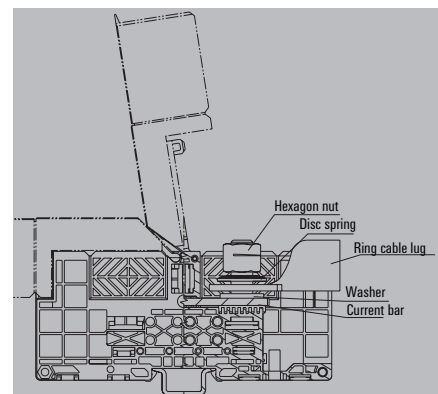

Auxiliary/control line connection WZAF

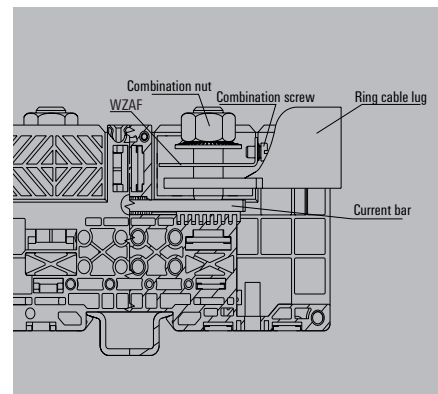

Stud terminals – Accessories

Series WF and WFF

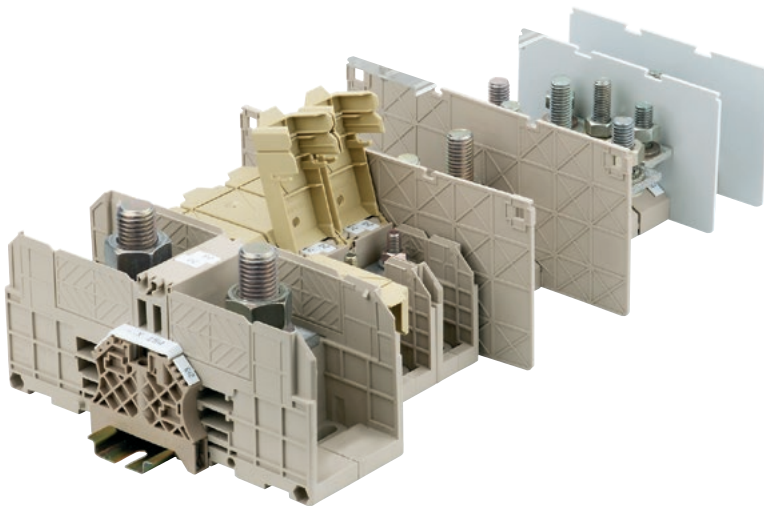

Electrical distribution



Electrical distribution can be realised between neighbouring stud terminals easily with 2 and 3 poles cross-connections. Cross-connections are also available for different thread sizes from M6 to M8 or M10. In the WFF two-stud terminals, firstly the partition plates have to be removed between the clamped supports. The thin web of material means they can be broken out easily to fit.

Shock protection



The two-stud terminals in the WF-Series offer, with an integrated hinge cover, a high degree of finger safety. When closed, the cover locks onto the terminal and protects the contact from accidental contact.

Shock protection / partition plates

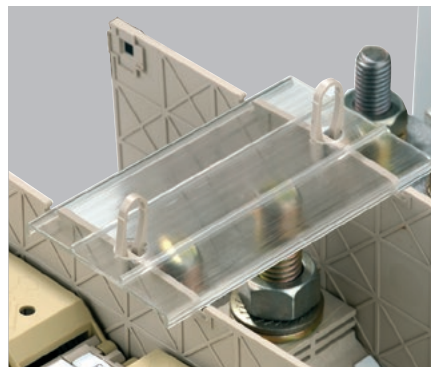

Shock protection in the WF-Series is provided by partition plates WTW and transparent cover strips ADP. The cover strips are locked into the guides of the partition plates and held with clips to prevent them slipping to the side.

Partition plates ensure compliance with the rated voltages:

- Voltage range up to 1000 V with partition plate WTW WF
- Voltage range up to 2300 V for WF with epoxy partition plate WTW WF 2300

Connection



Couldn't be easier: the cable lugs are placed on the stud with the washer and toothed washer on top. A normal open-ended spanner can be used to tighten the hex screw and complete installation.

Potential distribution from stud terminal blocks M10 to 2 x M6

The potential distribution between adjacent stud terminal blocks can be implemented simply using 2- and 3-pole cross-connections, please consult products in the stud terminal chapter.

Reduced cross-sections are required for special applications. These so-called cross-connection lugs are offered accordingly for varying thread sizes from M6 to M10 with a wide range of combinations.



Ordering data

Type	Qty.	Order No.
SMSE WF10/2XM6	10	1868880000

Note Hole diameter: 10 mm for M10 studs
Stud terminals: WF 10... and WFF 120. The rated current is dependent on the test set-up.

WQL special cross-connection lugs for WF

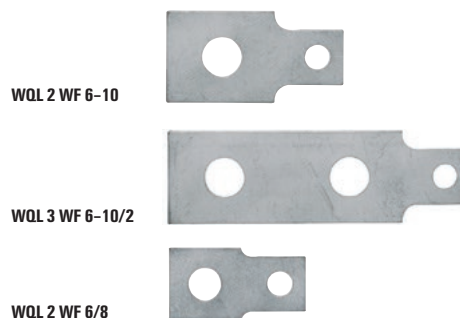

Ordering data

Type	Depth	current	Clamping screw	Terminal screw, additional connection	Qty.	Order No.
WQL 2 WFG-10	4 mm	125 A	M 6	M 10	5	1806620000
WQL 3 WFG-10/2	4 mm	125 A	M 6	M 10	5	1806640000
WQL 2 WFG-8	4 mm	125 A	M 6	M 8	5	1808980000
WQL 4 WFG-6/3	4 mm	24 A	M 8	M 6	5	1904960000
Note						



WF - cross-connections for WF and WFF



Type	Poles	current	Qty.	Order No.
WF 5				
WQL 2 WF5	2	101 A	5	1812710000
WQL 3 WF5	3	101 A	5	1812740000
WF 6 & WF 6/2BZ				
WQL 2 WF6	2	125 A	5	1780970000
WF 8 & WF 8/2BZ				
WQL 2 WF8	2	150 A	5	1780990000
WQL 3 WF8	3	150 A	5	1781000000
WF 10 & WF 10/2BZ				
WQL 2 WF10	2	265 A	5	1781010000
WQL 3 WF10	3	265 A	5	1781020000
WF 12				
WQL 2 WF12	2	265 A	5	1781030000
WQL 3 WF12	3	265 A	5	1781040000
WFF 35				
WQL 3 WFF35	3	150 A	5	1065400000
WFF 70				
WQL 3 WFF70	3	232 A	5	1065500000
WFF 120				
WQL 3 WFF120	3	309 A	5	1065600000
WFF 185				
WQL 3 WFF185	3	415 A	5	1065700000
WFF 300				
WQL 3 WFF300	3	520 A	5	1065800000
WF 6 & WF 6/2BZ				
WQL 3 WF6	3	125 A	5	1780980000
WF 10 & WF 10/2BZ				
WQL 4 WF10	4	265 A	5	1027840000
WFF 35				
WQL 2 WFF35	2	150 A	5	1064900000
WFF 70				
WQL 2 WFF70	2	232 A	5	1065000000
WFF 120				
WQL 2 WFF120	2	309 A	5	1065100000
WFF 185				
WQL 2 WFF185	2	415 A	5	1065200000
WFF 300				
WQL 2 WFF300	2	520 A	5	1065300000

WF-Series partition plates



Type	Colour	Width	Qty.	Order No.
WTW WF6-WF12	dark beige	2.5 mm	20	1781240000
WTW WF6	dark beige	3 mm	20	1781220000
WTW WF8	dark beige	3 mm	20	1780900000
WTW WF10/WF12	dark beige	3 mm	20	1780890000

WFF-Series partition plates



Type	Colour	Width	Qty.	Order No.
WTW WFF35	grey	2 mm	10	1067100000
WTW WFF70	grey	2 mm	10	1067200000
WTW WFF120	grey	2 mm	10	1067300000
WTW WFF185/300	grey	2 mm	10	1067400000



WFF series cover hoods



Type	Colour	Width	Qty.	Order No.
WAH 35	beige	26 mm	20	1064460000
WAH 70 BE	beige	31 mm	20	1064560000
WAH 120	beige	41 mm	20	1064660000
WAH 185/300 BE	beige	54 mm	10	1064760000

WF-Series 2300 V partition plates



Type	Colour	Width	Qty.	Order No.
WTW WF6 2300	grey	2 mm	20	1781230000
WTW WF8 2300	grey	2 mm	20	1780910000
WTW WF10/WF12 2300	grey	2 mm	20	1780920000

Warning triangle for power supply terminal blocks



Type	Colour	Width	Qty.	Order No.
SYMBOL-P. 25X25X25 B/DR	yellow	25 mm	120	1741090000
SYMBOL-P. 50X50X50 B/DR	yellow	50 mm	1	1741100000
MARKO-C. 25X25X25 B/DR.	yellow	25 mm	10	1700530001
MARKO-C. 50X50X50 B/DR.	yellow	50 mm	10	1700540001



Stud terminals

Series ST 4000

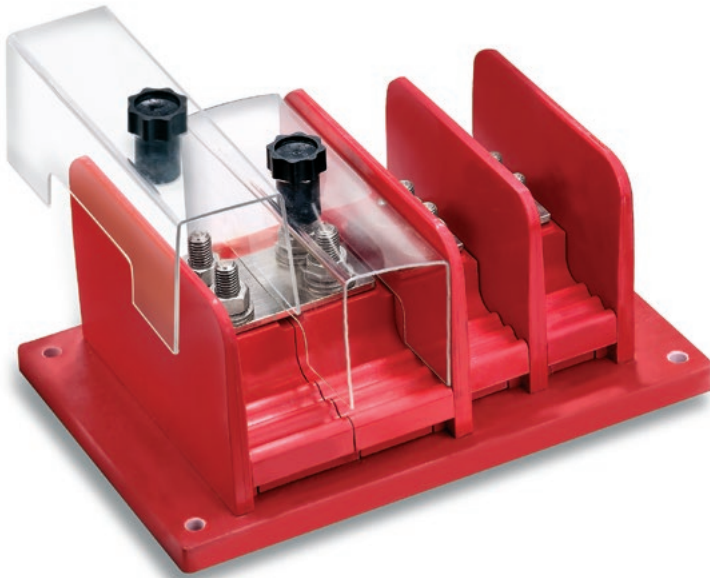

For especially high electric and mechanical demands

- Voltage ranges up to 4000 V and currents up to 415 A
- For extreme requirements, especially in railway applications

Shock protection



Stud terminals in the ST 4000 series offer an ideal cover for every version. The polycarbonate cover is placed between the partition plates and fastened to the stud with the plastic-coated fixing nut.

Fixing nuts are available to fit every stud size.

Potential distribution



When two neighbouring ST 4000 terminals have the same current, cross-connectors are fitted instead of the busbar.

The pairs of holes in the cross-connection are rated exactly to the spacing of ST 4000.

Here the partition plate has to be replaced by the connecting piece ST 4000/S C130 or ST 4000/L C160.

Cross-connections are available as 2-, 3-, or 4-poles.

Connection



Couldn't be easier: the cable lugs are placed on the stud with the washer and toothed washer on top. Tighten the steel hexagonal nut to ensure good contact between cable lug and busbar.

The same principle applies when two cable lugs contact on one stud or slotted hole cable lugs are used.

Slotted hole cable lugs can also be placed over both studs.

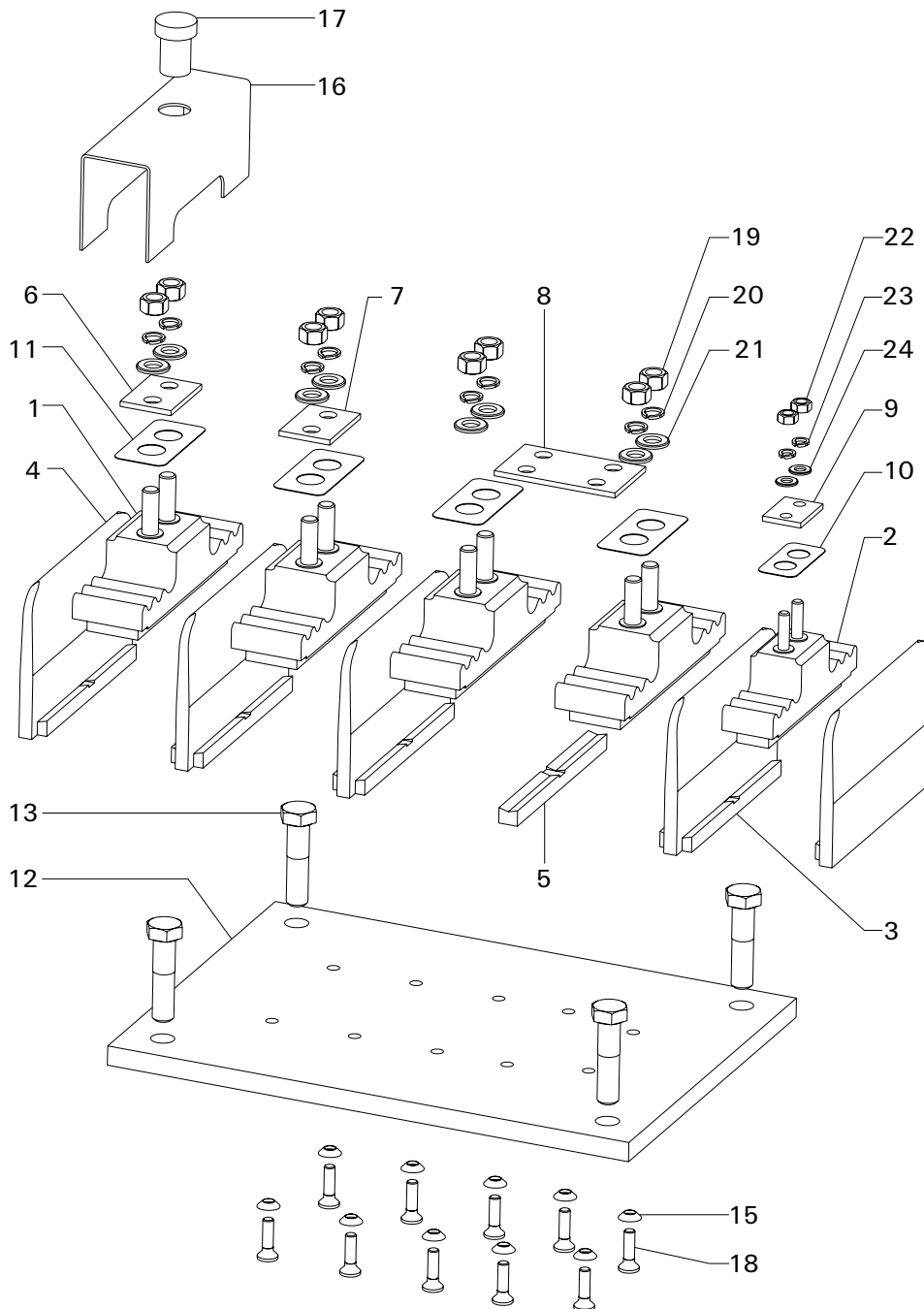

Modular System

- | | | | |
|-------|---------------------------------|-------|---|
| 1 | Stud terminal ST 4000/L (large) | 10/11 | Marking plate |
| 2 | Stud terminal ST 4000/S (small) | 12 | Insulating mounting base (customerspecific) |
| 3 | Partition | 13 | Studs and washers for the insulating mounting base (not part of the delivery) |
| 4 | Endplate | 15/18 | Studs and washers to fix the terminals on the insulating mounting base |
| 5 | Coupling block | 19-24 | Studs and washers (Fa. Teckentrup) |
| 6/7/9 | Current bar | | |
| 8 | Cross connection | | |

Screw connection with stud technology
Feed-through terminal blocks – ST 4000

Universal range

A

ST 4000/S M8

95 mm²

Screw thread M8

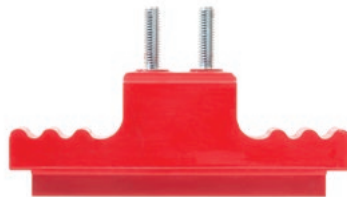

ST 4000/S M10

185 mm²

Screw thread M10

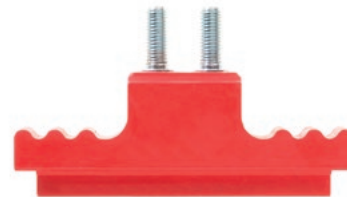

Width/Height/Depth	mm
max. current / max. cond. cross-section	A
Max. clamping range	mm ²

40 x 150 x 56	
315 / 95	
6...95	

40 x 150 x 56	
500 / 185	
16...185	

Technical data

Rated data with Wemid partition wall	
Rated voltage	V
Rated current	A
for wire cross-section	mm ²
Rated impulse withstand voltage / Pollution severity	
Gauge to IEC 60947-1 / UL 94 flammability rating	
Approvals	

EN 45545-2:2020, NFPA 130 ASTM E 162/ 662, BSS 7239/ 7242

EN 45545-2:2020, NFPA 130 ASTM E 162/ 662, BSS 7239/ 7242

IEC	UL	CSA	EN 60079-7
4000			
315			
95			
	25 kV / 3		
	/ V-0		

IEC	UL	CSA	EN 60079-7
4000			
500			
185			
	25 kV / 3		
	/ V-0		

Clamped cable lugs

- Cable lug to DIN 46234
- 2 x cable lugs DIN 46 234
- Cable lug to DIN 46235
- 2 x cable lugs DIN 46 235
- Tightening torque min./max.

6...95 mm ²
...18 Nm

16...185 mm ²
...35 Nm

Note

Rated voltage when using cable lugs according to DIN 46235

Rated voltage when using cable lugs according to DIN 46235

Ordering data

Version	
	with inner thread
	red

Note

Type	Qty.	Order No.
ST 4000/S M8 F	1	2743180000
ST 4000/S M8	1	2563830000

1000 VDC rated voltage tested. Weidmüller produces drawings of the customer-specific ST 4000 application.

Type	Qty.	Order No.
ST 4000/S M10 F	1	2743190000
ST 4000/S M10	1	2563860000

1000 VDC rated voltage tested. Weidmüller produces drawings of the customer-specific ST 4000 application.

Accessories

Cross-connector	
	2-pole
	3-pole
	4-pole
Busbar	
	M12 / 6 mm thick
	M8 / 4 mm thick
	M10 / 4 mm thick
	M10 / 6 mm thick
Connecting piece	
	160 mm length
	130 mm length
Spacer	
	180 mm length
	150 mm length
End partition	
	180 mm length
	150 mm length
Touch-safe protection	
	180 mm length
	150 mm length

Type	Qty.	Order No.
ST 4000/S J2 M8	1	2564010000
ST 4000/S J3 M8	1	2564020000
ST 4000/S CB M8/4	1	2563950000
ST 4000/S C130	1	2563930000
ST 4000/S P150	1	2563890000
ST 4000/S E150	1	2563910000
ST 4000/S S150	1	2564170000

Type	Qty.	Order No.
ST 4000/S CB M10/4	1	2563960000
ST 4000/S CB M10/6	1	2563970000
ST 4000/S C130	1	2563930000
ST 4000/S P150	1	2563890000
ST 4000/S E150	1	2563910000
ST 4000/S S150	1	2564170000

For detailed information on other accessories and application in the online catalogue

ST 4000/L M12

240 mm²

Screw thread M12



55 x 180 x 56

560 / 240

16...240

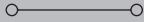

EN 45545-2:2020, NFPA 130 ASTM E
162/ 662, BSS 7239/ 7242

IEC	UL	CSA	EN 60079-7
4000			
560			
240			
	25 kV / 3		
	/ V-0		

16...240 mm²

...35 Nm

Rated voltage when using cable lugs according to DIN 46235

Type	Qty.	Order No.
ST 4000/L M12 F	1	2743200000
ST 4000/L M12	1	2563880000

1000 VDC rated voltage tested. Weidmüller produces drawings of the customer-specific ST 4000 application.

Type	Qty.	Order No.
ST 4000/L J2 M12	1	2564100000
ST 4000/L J3 M12	1	2564110000
ST 4000/L J4 M12	1	2564120000
ST 4000/L CB M12/6	1	2564000000
ST 4000/L C160	1	2563940000
ST 4000/L P180	1	2563900000
ST 4000/L E180	1	2563920000
ST 4000/L S180	1	2564180000



Screw connection with stud technology
Feed-through terminal blocks – HV 2700 and HV 4000

Universal range

A

HV2700/2-M12 F

185 mm²

Screw thread M12



HV2700/3-M12 F

185 mm²

Screw thread M12



Width/Height/Depth	mm
max. current / max. cond. cross-section	A
Max. clamping range	mm ²

180 x 220 x 90
600 / 185
10...185

240 x 220 x 90
600 / 185
10...185

Technical data

Rated data with Wemid partition wall	
Rated voltage	V
Rated current	A
for wire cross-section	mm ²
Rated impulse withstand voltage / Pollution severity	
Gauge to IEC 60947-1 / UL 94 flammability rating	
Approvals	

EN 45545-2:2020, NFPA 130 ASTM E 162/ 662, BSS 7239/ 7242

EN 45545-2:2020, NFPA 130 ASTM E 162/ 662, BSS 7239/ 7242

IEC	UL	CSA	EN 60079-7
2700			
600			
185			
	25 kV / 3		
	/ V-0		

IEC	UL	CSA	EN 60079-7
2700			
600			
185			
	25 kV / 3		
	/ V-0		

Clamped cable lugs

Cable lug to DIN 46234	
2 x cable lugs DIN 46 234	
Cable lug to DIN 46235	
2 x cable lugs DIN 46 235	
Tightening torque min./max.	

10...185 mm ²
33...35 Nm

10...185 mm ²
33...35 Nm

Note

In projects up to 1000 A rated current possible.

In projects up to 1000 A rated current possible.

Ordering data

Version	
	with inner thread
Note	

Type	Qty.	Order No.
HV2700/2-M12 F	1	2540680000

Type	Qty.	Order No.
HV2700/3-M12 F	1	2540690000

For detailed information on other accessories and application in the online catalogue

HV4000/2-M12 F

240 mm²

Screw thread M12



180 x 220 x 96.1
600 / 240
10...240

EN 45545-2:2020, NFPA 130 ASTM E
162/ 662, BSS 7239/ 7242

IEC	UL	CSA	EN 60079-7
4000			
600			
240			
	30 kV / 3		
	/ V-0		

10...240 mm²

63...65 Nm

In projects up to 1000 A rated current possible.

Type	Qty.	Order No.
HV4000/2-M12 F	1	2496040000

HV4000/3-M12 F

240 mm²

Screw thread M12



240 x 220 x 96.1
600 / 240
10...240

EN 45545-2:2020, NFPA 130 ASTM E
162/ 662, BSS 7239/ 7242

IEC	UL	CSA	EN 60079-7
4000			
600			
240			
	30 kV / 3		
	/ V-0		

10...240 mm²

63...65 Nm

In projects up to 1000 A rated current possible.

Type	Qty.	Order No.
HV4000/3-M12 F	1	2496050000





Application range

Application range	Application fields in the panel	B.2
	Power feed-in	B.4
	PUSH IN connection	B.6
	Screw connection	B.26
	Power distribution	B.50
	Hybrid connection	B.52
	Screw connection	B.54
	PUSH IN connection	B.94
	Tension clamp connection	B.95
	Control voltage distribution	B.98
	PUSH IN connection	B.100
	Instrument transformer wiring	B.126
	TTB Range	B.128
	Tension clamp connection	B.156
	Screw connection	B.158
	Threaded stud connection	B.180
	Signal wiring	B.182
	PUSH IN connection	B.184
	Tension clamp connection	B.188
	Screw connection	B.190
	Signal marshalling	B.196
	PUSH IN connection	B.203
	Screw connection	B.220
	Shielding and earthing	B.230
	Shield clamping saddle	B.234
	Potential equalisation terminal block	B.248
	Functional earth	B.251
	Earth conductor disconnect terminals	B.268
	Building installation wiring	B.270
	PUSH IN connection	B.272
	Screw connection	B.298

Panel building requires innovative ideas

Klippon® Connect delivers pioneering connectivity solutions

While panels are indeed configured individually, various recurring application fields within the panel are a permanent fixture in almost all industries.

We have identified and developed special solutions for these application fields. By purposefully structuring and adapting the product functions to the respective requirements, our needs-based application products decisively help to boost your productivity, efficiency and safety at all stages of the panel building process.

Our promise

Our tailored application range guarantees substantial efficiency benefits at every individual stage of the process and leads to unbeatable productivity gains in your panel building operations.

B

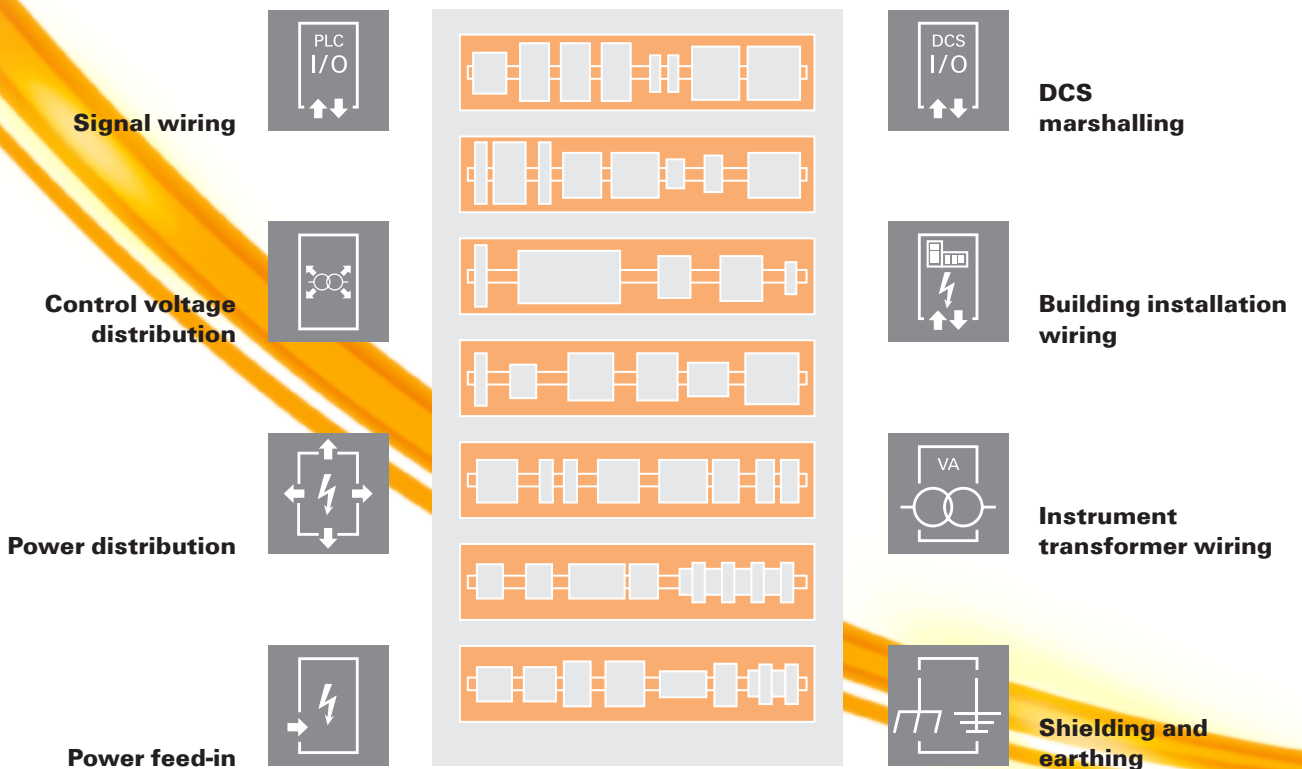



Power feed-in

Our wide range of W-Series terminal blocks with our WPD main line branch terminals, which are optimised to guarantee both convenience and space gains, ensures a secure and convenient connection at the power feed-in.



Power distribution

You safely and efficiently distribute electricity to the power consumers with our W-Series feed-through terminal blocks and our optimised WPD phase distribution blocks.



Control voltage distribution

Our tailored AAP potential distribution terminal blocks are ideal for surge current protection and central control voltage distribution. Meanwhile, our new maxGUARD range enables potential distribution with integrated electronic load monitoring in the smallest of installation spaces.



Instrument transformer wiring

Our test disconnect terminal blocks featuring spring and screw connection technology allow you to create all the important converter circuits for measuring current, voltage and power in a safe and sophisticated way.



Signal wiring

Tailored and particularly compact: with our AIO initiator/actuator terminal blocks, you are relying on an application-optimised solution for signal wiring. We also offer you other terminal blocks featuring spring and screw connection technology for signal wiring.



Signal marshalling

Our innovative PRV terminal blocks for Signal marshalling featuring a PUSH IN connection and our multifunctional Signal marshalling terminals featuring a screw connection (WMF) not only save space in the panel; they also guarantee more effective signal transmission in process control systems.



Shielding and earthing

Our protective earth conductor and shielding terminals featuring different connection technologies allow you to effectively protect both people and equipment from interference, such as electrical or magnetic fields. A comprehensive range of accessories rounds off our range.

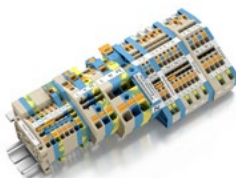

Building installation wiring

For building installations, we offer a complete system that revolves around the 10×3 copper rail and comprises perfectly coordinated components: from installation terminal blocks, neutral conductor terminal blocks and distribution terminal blocks to comprehensive accessories such as busbars and busbar holders.

Reliable and efficient power supply

Really convenient with Klippon® Connect



More and more components need to be housed in switchgear and panels within a confined space. As part of the power feed-in, connecting conductors is becoming increasingly challenging, especially for large cross-sections. Our comprehensive range of connection solutions also enables convenient wiring in challenging space conditions. The compact design and the combination of many practical handling benefits make the supply of power to switchgear and panels simple, efficient and space-saving.

Our promise

The feed-in of power to switchgear and panels is much easier with Klippon® Connect: our connection solutions ensure reduced wiring work and efficient processes. The compact design means you save space and money, whilst increasing productivity on a sustainable basis.

B

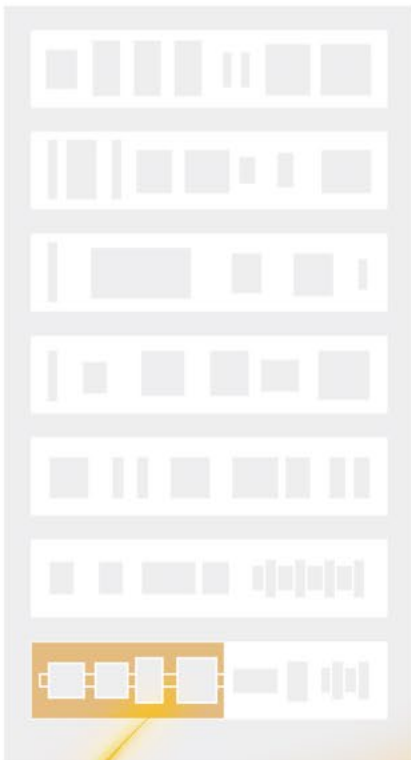

Space saving

- Small sizes save space in the control cabinet
- Uniform design simplifies project planning and reduces the number of accessories required

Flexibility

- Pre-assembled feed-in blocks for each network system
- Uniform accessories for multiple cross-sections

Time saving

- Reduced wiring effort, as the terminal blocks are always delivered with open connection points
- Innovative and intuitive PUSH IN Power connection

Safety

- Innovative and intuitive PUSH IN Power connection ensures a safe, gas-tight and vibration-proof connection of the conductor
- Marking of external voltage with additional markers

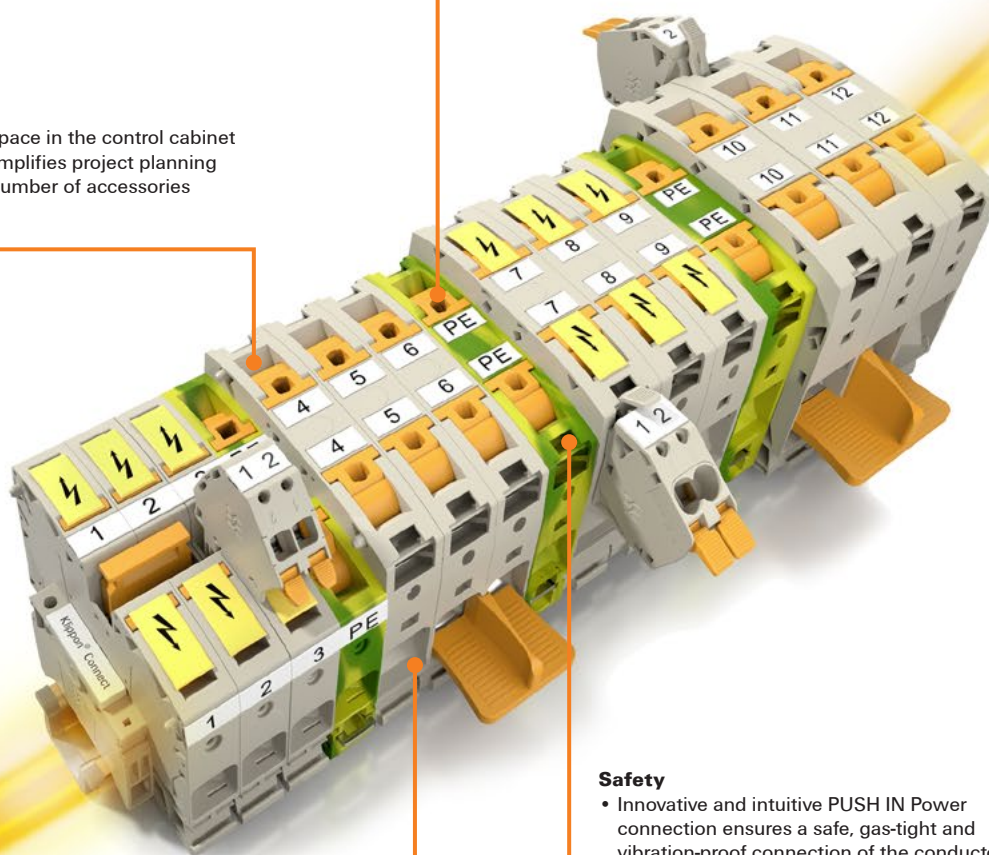
**Our range****Wide range – safe connections:**

In confined spaces, our compact terminal blocks with proven clamping yoke technology increase convenience and enable perfect connections. The strong force of the clamping yoke spring ensures vibration-resistant contacting and compensates for the relaxation in the connected conductor.

**Cost-effective and robust:**

Under harsh environmental conditions with high levels of vibration and shock, such as in traffic engineering, our terminal blocks using stud technology offer excellent safety. With robust workmanship and flexible accessories, our stud terminals meet the requirements for safe, reliable power transfer.



Reliable and efficient power supply

Klippon® Connect A2C 35 high-current terminal blocks

The industrial environment requires more and more flexible and efficient wiring of power consumers, without compromising a consistently high level of process reliability.

Our new A2C 35 high-current terminal blocks meet these requirements. The PUSH IN-Power connection and many other features enable safe and efficient wiring. They are available in a wide range of variants, including for the DIN rail, for direct mounting on mounting plates, and pre-assembled blocks for different network systems.



Find out more:

Discover all the details in the video. The new high-current terminal blocks A2C 35 with PUSH IN-Power connection: www.weidmuller.com/pushin-power

More on the benefits Klippon® Connect provides in planning, installation and operation: www.klippon-connect.com

Pre-assembled blocks

Pre-assembled feed-in blocks for each network system reduce the number of variants and storage costs. This supports installation on the standard DIN rail or direct fixation on the mounting plate using an integrated foot bracket.

Additional connection for emergency power supply

The additional connection enables a separate voltage tap. One possible use is as an emergency power supply upstream of the main switch. The lever mechanism enable toolless wiring of flexible conductors.

Innovative PUSH IN-Power connection

With the innovative PUSH IN-Power connection several compression springs provide a safe, gas-tight and vibration-proof Connection of the conductor. The mechanism provides high clamping forces with low operation forces for optimal operation. A uniformly scaled system, which can be found in the cross-sections of 35 mm² to 185 mm² ensures maximum contact forces.

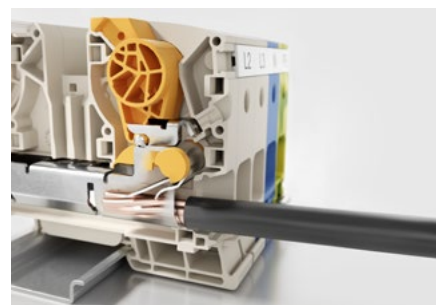
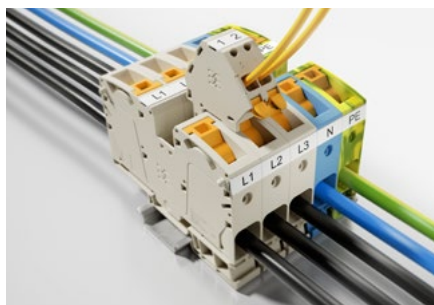



Efficient potential distribution

Step-down bridges allow potential distribution to cross-sections of 10 mm² and 16 mm². Additional power distributions implement quickly into the panel while avoiding additional wiring.

Standardised testing options

A standard 2.0 mm diameter test tap allows easy and fast testing. Standardised accessories guarantee use in the cross-section ranges from 1.5 mm² to 185 mm² and ensure a streamline portfolio of accessories.

Identification of external voltage

Large-area marker tags direct attention to an external voltage applied. The attachment of the flash markers in the connection ranges from 35 mm² to 185 mm² additionally prevent wiring in live condition. This ensures greater safety for man and machine.

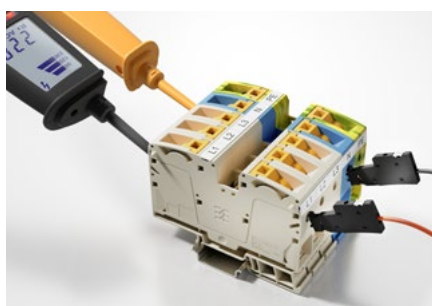
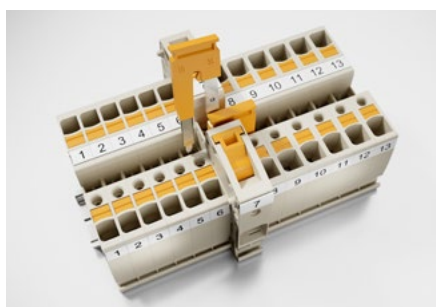

A2C 35 PE

35 mm²

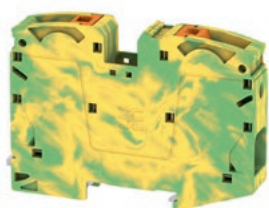

16 x 101 x 71.5
/ 35
2.5...35



IEC 60947-7-2

IEC	UL	CSA	EN 60079-7
1000 / 1500	1000		
35	AWG 12...2	AWG 12...2	35 mm ²
/ 3			
/ V-0			



TUEV16ATEX7909U

Rated connection

2.5...16 / 10...35
10...35 / 2.5...35
25 / 1.0 x 5.5 mm

Type	Qty.	Order No.
A2C 35 PE	10	2551520000

Type	Qty.	Order No.	
AAC 35 2X6 GN-YL	41 A	5	2583180000
AEB 35 SC/1	50	1991920000	
AEB 35 SCL/1 V0	20	2661280000	
ATPG 1.5-10 L	0.2 A	50	1991890000
PS 2.0 MC	20	0310000000	
SDS 1.0X5.5X150	1	2749380000	
AAM 35-185 YE FLASH	40	2635600000	
WS-A 8/16 MM WS	200	2619910000	

A2C 35 DM

35 mm²



16 x 135 x 71.5
125 / 35
2.5...35



IEC 60947-7-1

IEC	UL	CSA	EN 60079-7
1000 / 1500	1000	1000	880
125	113	101	105
35	AWG 12...2	AWG 12...2	35 mm ²
8 kV / 3			
/ V-0			



TUEV16ATEX7909U

Rated connection

2.5...16 / 10...35
10...35 / 2.5...35
25 / 1.0 x 5.5 mm

Type	Qty.	Order No.
A2C 35 DM	10	2551550000
A2C 35 BL DM	10	2552150000

Type	Qty.	Order No.	
ZQV 35N/2	125 A	10	2634950000
ZQV 35N-10	57 A	10	2562670000
ZQV 35N-16	76 A	10	2562660000
AAC 35 2X6	41 A	5	2583090000
AAC 35 2X6 BL	41 A	5	2583170000
AAC 35 2X6 BK-YL	41 A	5	2583190000
AAC 35 2X6 GN-YL	41 A	5	2583180000
ATPG 1.5-10 L	0.2 A	50	1991890000
PS 2.0 MC	20	0310000000	
SDS 1.0X5.5X150	1	2749380000	
AAM 35-185 YE FLASH	40	2635600000	
WS-A 8/16 MM WS	200	2619910000	

A2C 35 FE DM

35 mm²



16 x 135 x 71.5
125 / 35
2.5...35



IEC 60947-7-1

IEC	UL	CSA	EN 60079-7
1000 / 1500	1000		880
125			105
35	AWG 12...2	AWG 12...2	35 mm ²
8 kV / 3			
/ V-0			



TUEV16ATEX7909U

Rated connection

2.5...16 / 10...35
10...35 / 2.5...35
25 / 1.0 x 5.5 mm

Type	Qty.	Order No.
A2C 35 FE DM	10	2552160000

Type	Qty.	Order No.	
ZQV 35N/2	125 A	10	2634950000
ZQV 35N-10	57 A	10	2562670000
ZQV 35N-16	76 A	10	2562660000
AAC 35 2X6	41 A	5	2583090000
AAC 35 2X6 BL	41 A	5	2583170000
AAC 35 2X6 BK-YL	41 A	5	2583190000
AAC 35 2X6 GN-YL	41 A	5	2583180000
AEB 35 SC/1	50	1991920000	
AEB 35 SCL/1 V0	20	2661280000	
ATPG 1.5-10 L	0.2 A	50	1991890000
PS 2.0 MC	20	0310000000	
SDS 1.0X5.5X150	1	2749380000	
AAM 35-185 YE FLASH	40	2635600000	
WS-A 8/16 MM WS	200	2619910000	



**Power feed-in
PUSH IN connection**

Terminal blocks for rail mounting



Width/Height/Depth	mm
max. current / max. cond. cross-section	A/mm ²
Max. clamping range	mm ²

Technical data

Rated data	
Rated voltage	V/V DC
Rated current	A
for wire cross-section	mm ²
Rated impulse withstand voltage / Pollution severity	
Gauge to IEC 60947-1 / UL 94 flammability rating	
Approvals	
Clamped conductors (H05V/H07V)	
Solid / Stranded	mm ²
Flexible / Flexible with ferrule	mm ²
Stripping length / Blade size	mm/-

Note

Ordering data

Version	
	dark beige
	dark beige, blue
	dark beige, black/yellow
	dark beige, blue, black/yellow
	dark beige, green/yellow
	dark beige, blue, green/yellow

Note

Accessories

Plug-in cross-connection	
	2-pole
	2-pole
	2-pole
Additional tap	
	dark beige
	blue
	black/yellow
	green/yellow
End bracket	
	dark beige, screwable
	dark beige, direct mounting
Test adapter	
	1-pole
Test plug	
Screwdriver	
	Standard
Warning labels	
Marking tags	

For detailed information on other accessories and application in the online catalogue

A2C 35 3FT

35 mm²



48 x 101.5 x 71.5	
125 / 35	
2.5...35	

IEC 60947-7-1			
IEC	UL	CSA	EN 60079-7
1000 / 1500	1000	1000	880
125	113	101	105
35	AWG 12...2	AWG 12...2	35 mm ²
8 kV / 3 / V-0			
TUEV16ATEX7909U			
Rated connection			
2.5...16 / 10...35			
10...35 / 2.5...35			
25 / 1.0 x 5.5 mm			

Type	Qty.	Order No.
A2C 35 3FT	1	2552100000
A2C 35 3FT-N	1	2552130000

Type	Qty.	Order No.
ZQV 35N/2	125 A 10	2634950000
ZQV 35N-10	57 A 10	2562670000
ZQV 35N-16	76 A 10	2562660000
AAC 35 2X6	41 A 5	2583090000
AAC 35 2X6 BL	41 A 5	2583170000
AAC 35 2X6 BK-YL	41 A 5	2583190000
AAC 35 2X6 GN-YL	41 A 5	2583180000
AEB 35 SC/1	50	1991920000
AEB 35 SCL/1 V0	20	2661280000
ATPG 1.5-10 L	0.2 A 50	1991890000
PS 2.0 MC	20	0310000000
SDS 1.0X5.5X150	1	2749380000
AAM 35-185 YE FLASH	40	2635600000
WS-A 8/16 MM WS	200	2619910000

A2C 35 3FT-FE

35 mm²



64 x 101.5 x 71.5	
125 / 35	
2.5...35	

IEC 60947-7-1, IEC 60947-7-2			
IEC	UL	CSA	EN 60079-7
1000 / 1500	1000	1000	880
125	113	101	105
35	AWG 12...2	AWG 12...2	35 mm ²
8 kV / 3 / V-0			
TUEV16ATEX7909U			
Rated connection			
2.5...16 / 10...35			
10...35 / 2.5...35			
25 / 1.0 x 5.5 mm			

Type	Qty.	Order No.
A2C 35 3FT-FE	1	2552110000
A2C 35 3FT-N-FE	1	2552140000

Type	Qty.	Order No.
ZQV 35N/2	125 A 10	2634950000
ZQV 35N-10	57 A 10	2562670000
ZQV 35N-16	76 A 10	2562660000
AAC 35 2X6	41 A 5	2583090000
AAC 35 2X6 BL	41 A 5	2583170000
AAC 35 2X6 BK-YL	41 A 5	2583190000
AAC 35 2X6 GN-YL	41 A 5	2583180000
AEB 35 SC/1	50	1991920000
AEB 35 SCL/1 V0	20	2661280000
ATPG 1.5-10 L	0.2 A 50	1991890000
PS 2.0 MC	20	0310000000
SDS 1.0X5.5X150	1	2749380000
AAM 35-185 YE FLASH	40	2635600000
WS-A 8/16 MM WS	200	2619910000

For detailed information on other accessories and application in the online catalogue



A2C 35 3FT-PE

35 mm²

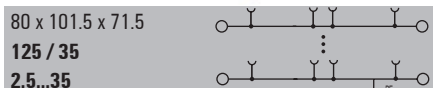

IEC 60947-7-1, IEC 60947-7-2

IEC	UL	CSA	EN 60079-7
1000 / 1500	1000	1000	880
125	113	101	105
35	AWG 12...2	AWG 12...2	35 mm ²
8 kV / 3 / V-0			

TUEV16ATEX7909U

Rated connection

2.5...16 / 10...35
10...35 / 2.5...35
25 / 1.0 x 5.5 mm

Type	Qty.	Order No.
A2C 35 3FT-PE	1	2552120000
A2C 35 3FT-NPE	1	2551540000

Type	Qty.	Order No.
ZQV 35N/2	125 A	10 2634950000
ZQV 35N-10	57 A	10 2562670000
ZQV 35N-16	76 A	10 2562660000
AAC 35 2X6	41 A	5 2583090000
AAC 35 2X6 BL	41 A	5 2583170000
AAC 35 2X6 BK-YL	41 A	5 2583190000
AAC 35 2X6 GN-YL	41 A	5 2583180000
AEB 35 SC/1	50	1991920000
AEB 35 SCL/1 V0	20	2661280000
ATPG 1.5-10 L	0.2 A	50 1991890000
PS 2.0 MC	20	0310000000
SDS 1.0X5.5X150	1	2749380000
AAM 35-185 YE FLASH	40	2635600000
WS-A 8/16 MM WS	200	2619910000

A2C 35 3FT DM

35 mm²

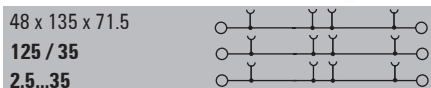

IEC 60947-7-1

IEC	UL	CSA	EN 60079-7
1000 / 1500	1000	1000	880
125	113	101	105
35	AWG 12...2	AWG 12...2	35 mm ²
8 kV / 3 / V-0			

TUEV16ATEX7909U

Rated connection

2.5...16 / 10...35
10...35 / 2.5...35
25 / 1.0 x 5.5 mm

Type	Qty.	Order No.
A2C 35 3FT DM	1	2552170000
A2C 35 3FT-N DM	1	2552190000

Type	Qty.	Order No.
ZQV 35N/2	125 A	10 2634950000
ZQV 35N-10	57 A	10 2562670000
ZQV 35N-16	76 A	10 2562660000
AAC 35 2X6	41 A	5 2583090000
AAC 35 2X6 BL	41 A	5 2583170000
AAC 35 2X6 BK-YL	41 A	5 2583190000
AAC 35 2X6 GN-YL	41 A	5 2583180000
AEB 35 SC/1	50	1991920000
AEB 35 SCL/1 V0	20	2661280000
ATPG 1.5-10 L	0.2 A	50 1991890000
PS 2.0 MC	20	0310000000
SDS 1.0X5.5X150	1	2749380000
AAM 35-185 YE FLASH	40	2635600000
WS-A 8/16 MM WS	200	2619910000

A2C 35 3FT-FE DM

35 mm²

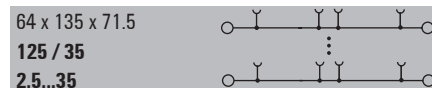

IEC 60947-7-1, IEC 60947-7-2

IEC	UL	CSA	EN 60079-7
1000 / 1500	1000	1000	880
125	113	101	105
35	AWG 12...2	AWG 12...2	35 mm ²
8 kV / 3 / V-0			

TUEV16ATEX7909U

Rated connection

2.5...16 / 10...35
10...35 / 2.5...35
25 / 1.0 x 5.5 mm

Type	Qty.	Order No.
A2C 35 3FT-FE DM	1	2552180000
A2C 35 3FT-NFE DM	1	2552200000

Type	Qty.	Order No.
ZQV 35N/2	125 A	10 2634950000
ZQV 35N-10	57 A	10 2562670000
ZQV 35N-16	76 A	10 2562660000
AAC 35 2X6	41 A	5 2583090000
AAC 35 2X6 BL	41 A	5 2583170000
AAC 35 2X6 BK-YL	41 A	5 2583190000
AAC 35 2X6 GN-YL	41 A	5 2583180000
AEB 35 SC/1	50	1991920000
AEB 35 SCL/1 V0	20	2661280000
ATPG 1.5-10 L	0.2 A	50 1991890000
PS 2.0 MC	20	0310000000
SDS 1.0X5.5X150	1	2749380000
AAM 35-185 YE FLASH	40	2635600000
WS-A 8/16 MM WS	200	2619910000



Mounting in compliance with norms

Thanks to precisely matched accessories

When assembling terminal blocks and equipping panels you must be able to rely on the fact, that the accessories are also perfectly matched. Only then can the processes run smoothly and productively. Correspondingly there are high requirements for mounting rails, cross-connections and cover plates as well as additional connections. They must comply with numerous norms and protective provisions.

The comprehensive accessories of the Klippon® Connect portfolio are perfectly matched down to the last detail. This facilitates mounting while adhering to required norms.

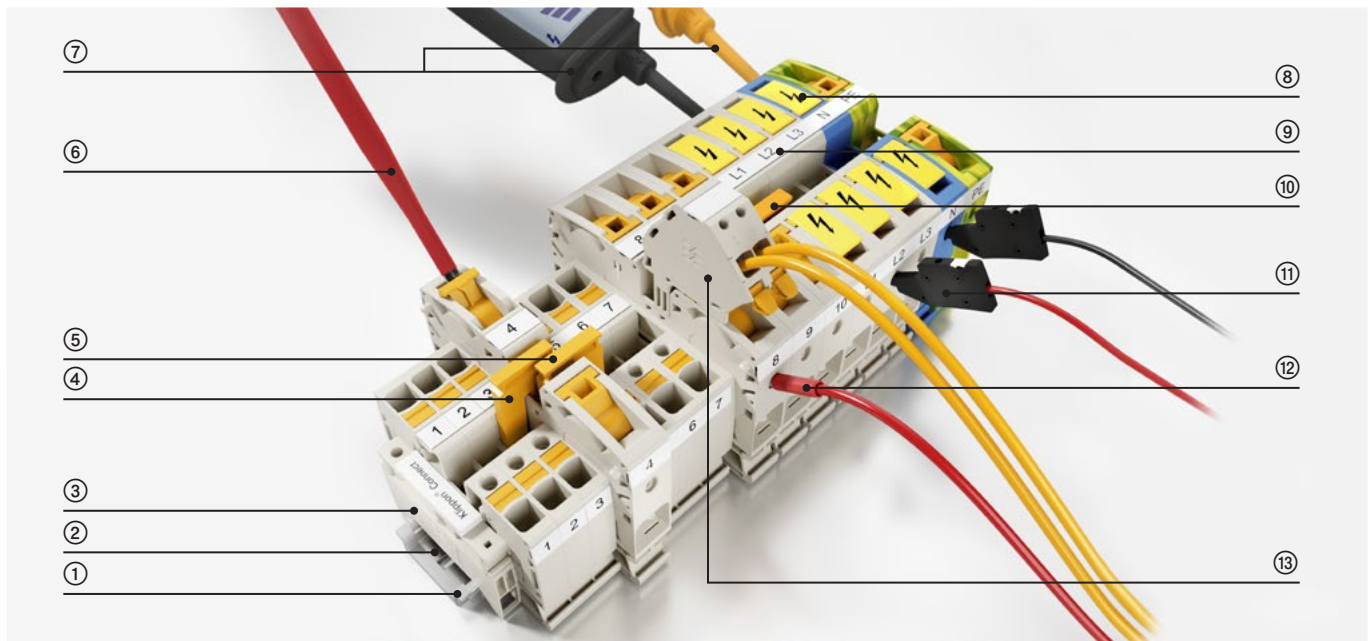

Number	Description	Type	Rated voltage	Rated current	Dimensions	Colour	Qty.	Order No.
1	End plate terminal rail	TS END CAP 35X7.5			35 x 7.5 x 4 mm	grey	100	1283470000
2	Terminal rail	TS 35X7.5/LL 2M/ST/ZN			35 x 7.5 x 2000 mm	silver	2	0514500000
3	End bracket	AEB 35 SC/1			8 x 58 x 36 mm	dark beige	50	1991920000
4	Step-down bridges	ZQV 35N-10	1000 V AC / 1500 V DC	70 A	55 x 55 x 55 mm	orange	20	2562670000
5	Step-down bridges	ZQV 35N-16	1000 V AC / 1500 V DC	70 A	55 x 55 x 55 mm	orange	20	2562660000
6	Screwdriver	SDS 1.0X5.5X150			1.0 x 5.5 x 150 mm	black/orange	1	2749380000
7	Voltage tester	VT DIGI PRO	1000 V AC / 1000 V DC		264 x 33 x 67 mm	black/orange	1	9918870000
8	Warning cover	AAM 35-185 YE FLASH			55 x 55 x 55 mm	yellow	40	2635600000
9	Terminal marker	WS-A 8/16 MM WS			8 x 16 mm	white	200	2619910000
10	Cross-connector	ZQV 35N/2	1000 V AC / 1500 V DC	70 A	55 x 55 x 55 mm	orange	20	2634950000
11	Test adapter	ATPG 1.5-10 L	250 V AC / 250 V DC	0.2 A	55 x 55 x 55 mm	black	50	1991890000
12	Test probes	PS 2.0 MC	250 V AC / 250 V DC	0.2 A	55 x 55 x 55 mm	red	20	0310000000
13	Additional voltage tap	AAC 35 2X6	1000 V AC / 1500 V DC	42 A	55 x 55 x 55 mm	dark beige	10	2583090000
13	Additional voltage tap	AAC 35 2X6 BL	1000 V AC / 1500 V DC	42 A	55 x 55 x 55 mm	blue	10	2583170000
13	Additional voltage tap	AAC 35 2X6 BK-YL	1000 V AC / 1500 V DC	42 A	55 x 55 x 55 mm	black/yellow	10	2583190000
13	Additional voltage tap	AAC 35 2X6 GN-YL	1000 V AC / 1500 V DC	42 A	55 x 55 x 55 mm	green/yellow	10	2583180000



Reliable and efficient power subbly

Klippon® Connect high current terminal blocks for optimal energy supply

The industrial environment requires more and more flexible and efficient wiring of power consumers, without compromising a consistently high level of process reliability.

Our new high-current terminal blocks meet these requirements. The PUSH IN-Power connection and many other features enable safe and efficient wiring. They are available in a wide range of variants, including for the DIN rail, for direct mounting on mounting plates, and pre-assembled blocks for different network systems.

B



Innovative PUSH IN-Power connection

With the innovative PUSH IN-Power connection several compression springs provide a safe, gas-tight and vibration-proof Connection of the conductor. The mechanism provides high clamping forces with low operation forces for optimal operation. A uniformly scaled system, which can be found in the cross-sections of 35 mm² to 185 mm² ensures maximum contact forces.

Pre-assembled blocks

Pre-assembled feed-in blocks for each network system reduce the number of variants and storage costs. This supports installation on the standard DIN rail or direct fixation on the mounting plate using an integrated foot bracket.

Standardised testing options

A standard 2.0 mm diameter test tap allows easy and fast testing. Standardized accessories guarantee use in the cross-section ranges from 1.5 mm² to 185 mm² and ensure a streamline portfolio of accessories.

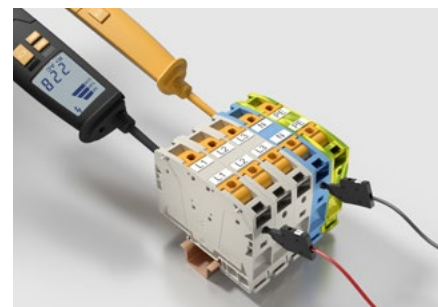
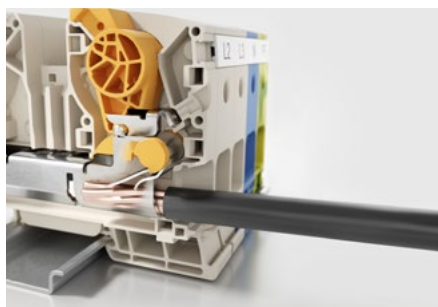

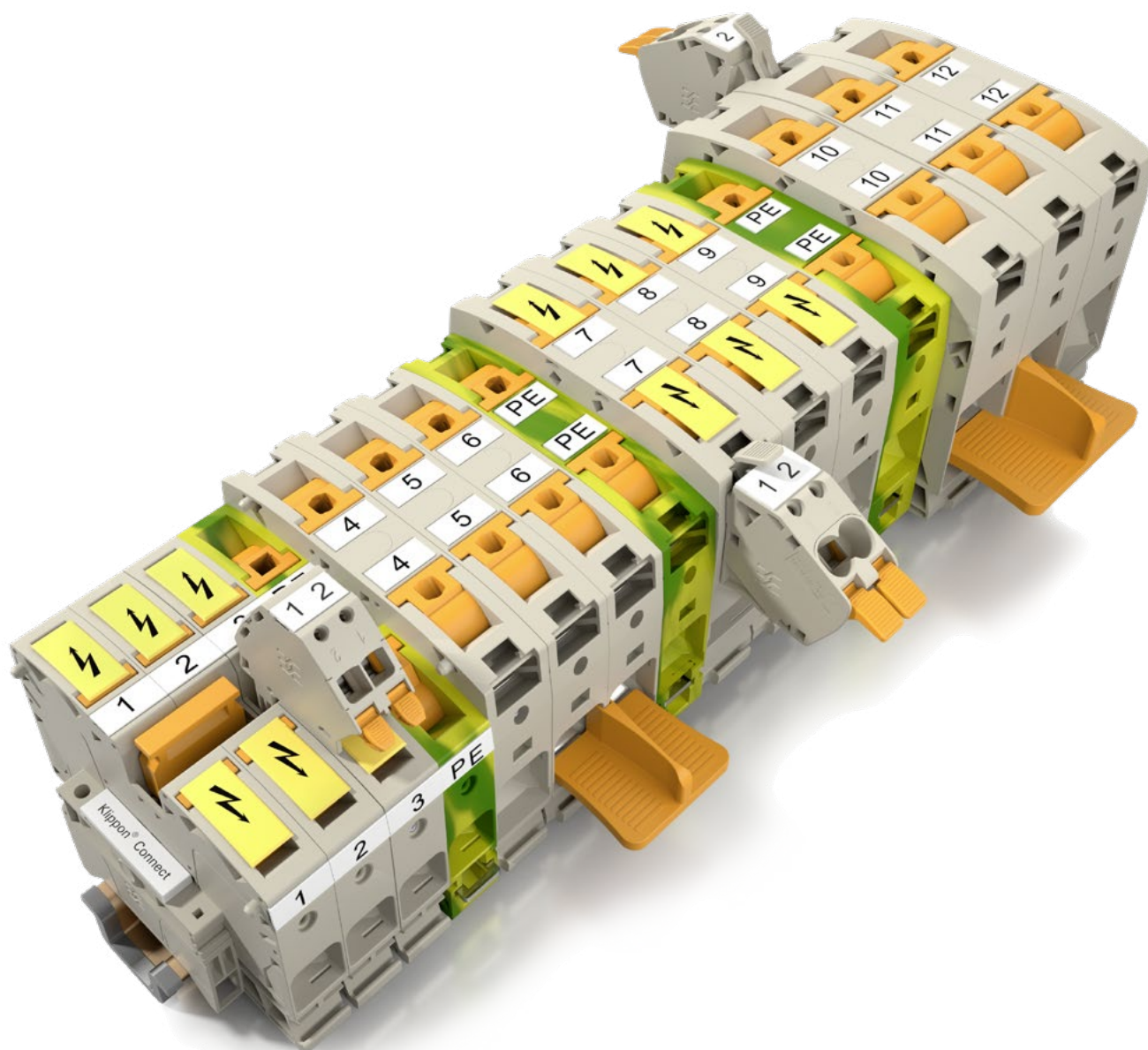

Identification of external voltage

Large-area marker tags direct attention to an external voltage applied. Fixation of the flash markers in the connection areas of 35 mm² to 185 mm² also prevents circuitry in the live state. This ensures greater safety for man and machine.

Efficient potential distribution

The cross connections could be installed tool less by latching the wire inside the connection point. The electrical contact will be given with or without a cable inside the connection point. Thanks to their special design, they could be easily identified with or without any conductor connection.

Additional connection for emergency power supply

The additional connection for the cross section from 50 mm² up to 185 mm² enables a separate voltage tap. One possible use is as an emergency power supply upstream of the main switch. The lever mechanism enable tool less wiring of flexible conductors.

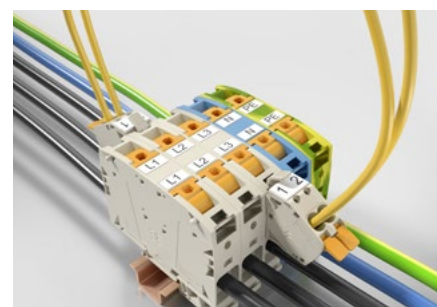
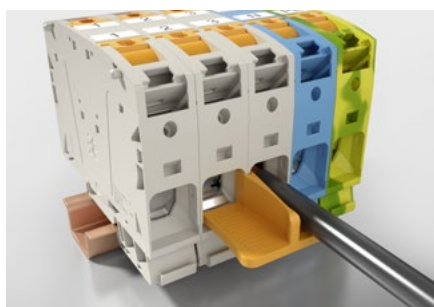

**Power feed-in
PUSH IN connection**

Terminal blocks for rail mounting



Width/Height/Depth	mm
max. current / max. cond. cross-section	A/mm ²
Max. clamping range	mm ²

Technical data

Rated data	
Rated voltage	V/V DC
Rated current	A
for wire cross-section	mm ²
Rated impulse withstand voltage / Pollution severity	
Gauge to IEC 60947-1 / UL 94 flammability rating	
Approvals	
Clamped conductors (H05V/H07V)	
Solid / Stranded	mm ²
Flexible / Flexible with ferrule	mm ²
Stripping length / Blade size	mm/-
Note	

Ordering data

Version	
	dark beige
	Blue
	Green/yellow
	yellow/black
Note	

Accessories

Cross connections insertable	
	2-pole
Additional tap	
	dark beige
	blue
	black/yellow
	green/yellow
End bracket	
	dark beige, screwable
	dark beige, direct mounting
Test adapter	
	1-pole
Test plug	
Screwdriver	
	Standard
Warning labels	
Marking tags	

For detailed information on other accessories and application in the online catalogue

A2C 50/70

50 mm²



20 x 101.5 x 80.5
150 / 70
10...70

IEC 60947-7-1

IEC	UL	CSA	EN 60079-7
1000 / 1500	1000	1000	
150	175	175	
50	AWG 8...0	AWG 8...NaN	
8 kV / 3			
/ V-0			

CE, UL, VDE, TÜV

Rated connection	
10...70 / 10...70	
10...70 / 10...50	
30 / 1.0 x 5.5 mm	

If a cross-connection is mounted next to a PE terminal block or a terminal block for direct mounting, the rated voltage is reduced to 1000 V DC.

Type	Qty.	Order No.
A2C 50/70	5	2663250000
A2C 50/70 BL	5	2663260000

Type	Qty.	Order No.
ZQV 50/70N/2	150 A 10	2663400000
AAC 50-185 2X10	57 A 5	2663420000
AAC 50-185 2X10 BL	57 A 5	2663430000
AAC 50-185 2X10 BK-YL	57 A 5	2663450000
AAC 50-185 2X10 GN-YL	57 A 5	2663440000
AEB 35 SC/1	50	1991920000
AEB 35 SCL/1 V0	20	2661280000
ATPG 1.5-10 L	0.2 A 50	1991890000
PS 2.0 MC	20	0310000000
SDS 1.0X5.5X150	1	2749380000
AAM 35-185 YE FLASH	40	2635600000
WS-A 8/16 MM WS	200	2619910000

A2C 50/70 FE

50 mm²



20 x 101.5 x 80.5
150 / 70
10...70

IEC 60947-7-1

IEC	UL	CSA	EN 60079-7
1000 / 1500	1000	1000	
150			
50	AWG 8...0	AWG 8...NaN	
8 kV / 3			
/ V-0			

CE, UL, VDE, TÜV

Rated connection	
10...16 / 10...70	
10...70 / 10...50	
30 / 1.0 x 5.5 mm	

If a cross-connection is mounted next to a PE terminal block or a terminal block for direct mounting, the rated voltage is reduced to 1000 V DC.

Type	Qty.	Order No.
A2C 50/70 FE	5	2663270000

Type	Qty.	Order No.
ZQV 50/70N/2	150 A 10	2663400000
AAC 50-185 2X10	57 A 5	2663420000
AAC 50-185 2X10 BL	57 A 5	2663430000
AAC 50-185 2X10 BK-YL	57 A 5	2663450000
AAC 50-185 2X10 GN-YL	57 A 5	2663440000
AEB 35 SC/1	50	1991920000
AEB 35 SCL/1 V0	20	2661280000
ATPG 1.5-10 L	0.2 A 50	1991890000
PS 2.0 MC	20	0310000000
SDS 1.0X5.5X150	1	2749380000
AAM 35-185 YE FLASH	40	2635600000
WS-A 8/16 MM WS	200	2619910000

A2C 50/70 PE

50 mm²



20 x 101.5 x 80.5
/ 70
10...70



IEC 60947-7-2

IEC	UL	CSA	EN 60079-7
/ 1500	1000	1000	
50	AWG 8...0	AWG 8...NaN	
	/ 3		
	/ V-0		

Rated connection

10...70 / 10...70
10...70 / 10...50
30 / 1.0 x 5.5 mm

If a cross-connection is mounted next to a PE terminal block or a terminal block for direct mounting, the rated voltage is reduced to 1000 V DC.

Type	Qty.	Order No.
A2C 50/70 PE	5	2663280000

For 50 - 185 mm², the TS 35 x 15 (copper, 2.3 mm thick) mounting rail should be used.

Type	Qty.	Order No.	
AAC 50-185 2X10 GN-YL	57 A	5	2663440000
AEB 35 SC/1	50	1991920000	
AEB 35 SCL/1 V0	20	2661280000	
ATPG 1.5-10 L	0.2 A	50	1991890000
PS 2.0 MC	20	0310000000	
SDS 1.0X5.5X150	1	2749380000	
AAM 35-185 YE FLASH	40	2635600000	
WS-A 8/16 MM WS	200	2619910000	

A2C 50/70-DM

50 mm²



20 x 134 x 80.5
150 / 70
10...70

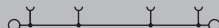

IEC 60947-7-1

IEC	UL	CSA	EN 60079-7
1000 / 1500	1000	1000	
150	175	175	
50	AWG 8...0	AWG 8...NaN	
	8 kV / 3		
	/ V-0		

Rated connection

10...70 / 10...70
10...70 / 10...50
30 / 1.0 x 5.5 mm

If a cross-connection is mounted next to a PE terminal block or a terminal block for direct mounting, the rated voltage is reduced to 1000 V DC.

Type	Qty.	Order No.
A2C 50/70-DM	5	2663330000
A2C 50/70 BL-DM	5	2663340000

Type	Qty.	Order No.	
ZQV 50/70N/2	150 A	10	2663400000
AAC 50-185 2X10	57 A	5	2663420000
AAC 50-185 2X10 BL	57 A	5	2663430000
AAC 50-185 2X10 BK-YL	57 A	5	2663450000
AAC 50-185 2X10 GN-YL	57 A	5	2663440000
ATPG 1.5-10 L	0.2 A	50	1991890000
PS 2.0 MC	20	0310000000	
SDS 1.0X5.5X150	1	2749380000	
AAM 35-185 YE FLASH	40	2635600000	
WS-A 8/16 MM WS	200	2619910000	

A2C 50/70 FE-DM

50 mm²

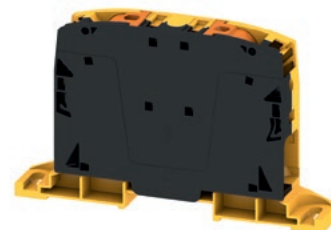

20 x 134 x 80.5
150 / 70
10...70

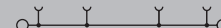

IEC 60947-7-1

IEC	UL	CSA	EN 60079-7
1000 / 1500	1000	1000	
150			
50	AWG 8...0	AWG 8...NaN	
	8 kV / 3		
	/ V-0		

Rated connection

10...16 / 10...70
10...70 / 10...50
30 / 1.0 x 5.5 mm

If a cross-connection is mounted next to a PE terminal block or a terminal block for direct mounting, the rated voltage is reduced to 1000 V DC.

Type	Qty.	Order No.
A2C 50/70 FE-DM	5	2663350000

Type	Qty.	Order No.	
ZQV 50/70N/2	150 A	10	2663400000
AAC 50-185 2X10	57 A	5	2663420000
AAC 50-185 2X10 BL	57 A	5	2663430000
AAC 50-185 2X10 BK-YL	57 A	5	2663450000
AAC 50-185 2X10 GN-YL	57 A	5	2663440000
ATPG 1.5-10 L	0.2 A	50	1991890000
PS 2.0 MC	20	0310000000	
SDS 1.0X5.5X150	1	2749380000	
AAM 35-185 YE FLASH	40	2635600000	
WS-A 8/16 MM WS	200	2619910000	



**Power feed-in
PUSH IN connection**

Terminal blocks for rail mounting



Width/Height/Depth	mm
max. current / max. cond. cross-section	A/mm ²
Max. clamping range	mm ²

Technical data

Rated data	
Rated voltage	V/V DC
Rated current	A
for wire cross-section	mm ²
Rated impulse withstand voltage / Pollution severity	
Gauge to IEC 60947-1 / UL 94 flammability rating	
Approvals	
Clamped conductors (H05V/H07V)	
Solid / Stranded	mm ²
Flexible / Flexible with ferrule	mm ²
Stripping length / Blade size	mm/-

Note

Ordering data

Version	
	dark beige
	Blue
	Green/yellow
	yellow/black
Note	

Accessories

Cross connections insertable	
	2-pole
	3-pole
Additional tap	
	dark beige
	blue
	black/yellow
	green/yellow
End bracket	
	dark beige, screwable
	dark beige, direct mounting
Test adapter	
	1-pole
Test plug	
Screwdriver	
	Standard
Warning labels	
Marking tags	

For detailed information on other accessories and application in the online catalogue

A2C 95/120

95 mm²



25 x 101.5 x 90
232 / 120
25...120

IEC 60947-7-1

IEC	UL	CSA	EN 60079-7
1000 / 1500	600		
232	255		
95	AWG 4...250		
8 kV / 3			
/ V-0			

CE, RoHS, REACH

Rated connection		
25...120 / 25...120		
25...120 / 25...95		
40 / 1.0 x 5.5 mm		

If a cross-connection is mounted next to a PE terminal block or a terminal block for direct mounting, the rated voltage is reduced to 1000 V DC.

Type	Qty.	Order No.
A2C 95/120	5	2694060000
A2C 95/120 BL	5	2694070000

Type	Qty.	Order No.
ZQV 95/120N/2	192 A 10	2694250000
ZQV 95/120N/3	192 A 10	2694260000
AAC 50-185 2X10	57 A 5	2663420000
AAC 50-185 2X10 BL	57 A 5	2663430000
AAC 50-185 2X10 BK-YL	57 A 5	2663450000
AAC 50-185 2X10 GN-YL	57 A 5	2663440000
AEB 35 SC/1	50	1991920000
AEB 35 SCL/1 V0	20	2661280000
ATPG 1.5-10 L	0.2 A 50	1991890000
PS 2.0 MC	20	0310000000
SDS 1.0X5.5X150	1	2749380000
AAM 35-185 YE FLASH	40	2635600000
WS-A 8/16 MM WS	200	2619910000

A2C 95/120 FE

95 mm²



25 x 101.5 x 90
232 / 120
25...120

IEC 60947-7-1

IEC	UL	CSA	EN 60079-7
1000 / 1500			
232			
95	AWG 4...0		
8 kV / 3			
/ V-0			

CE, RoHS

Rated connection		
25...120 / 25...120		
25...120 / 25...95		
40 / 1.0 x 5.5 mm		

If a cross-connection is mounted next to a PE terminal block or a terminal block for direct mounting, the rated voltage is reduced to 1000 V DC.

Type	Qty.	Order No.
A2C 95/120 FE	5	2694080000

Type	Qty.	Order No.
ZQV 95/120N/2	192 A 10	2694250000
ZQV 95/120N/3	192 A 10	2694260000
AAC 50-185 2X10	57 A 5	2663420000
AAC 50-185 2X10 BL	57 A 5	2663430000
AAC 50-185 2X10 BK-YL	57 A 5	2663450000
AAC 50-185 2X10 GN-YL	57 A 5	2663440000
AEB 35 SC/1	50	1991920000
AEB 35 SCL/1 V0	20	2661280000
ATPG 1.5-10 L	0.2 A 50	1991890000
PS 2.0 MC	20	0310000000
SDS 1.0X5.5X150	1	2749380000
AAM 35-185 YE FLASH	40	2635600000
WS-A 8/16 MM WS	200	2619910000

A2C 95/120 PE

95 mm²

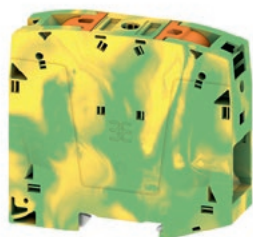

25 x 101.5 x 90
/ 120
25...120

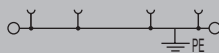

IEC 60947-7-2

IEC	UL	CSA	EN 60079-7
1000 / 1500			
95	AWG 4...0		
	/ 3		
	/ V-0		



Rated connection

25...120 / 25...120
25...120 / 25...95
40 / 1.0 x 5.5 mm

If a cross-connection is mounted next to a PE terminal block or a terminal block for direct mounting, the rated voltage is reduced to 1000 V DC.

Type	Qty.	Order No.
A2C 95/120 PE	5	2694090000

For 50 - 185 mm², the TS 35 x 15 (copper, 2.3 mm thick) mounting rail should be used.

Type	Qty.	Order No.	
AAC 50-185 2X10 GN-YL	57 A	5	2663440000
AEB 35 SC/1	50	1991920000	
AEB 35 SCL/1 VO	20	2661280000	
ATPG 1.5-10 L	0.2 A	50	1991890000
PS 2.0 MC	20	0310000000	
SDS 1.0X5.5X150	1	2749380000	
AAM 35-185 YE FLASH	40	2635600000	
WS-A 8/16 MM WS	200	2619910000	

A2C 95/120-DM

95 mm²



25 x 133.5 x 90
232 / 120
25...120

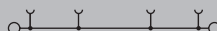

IEC 60947-7-1

IEC	UL	CSA	EN 60079-7
1000 / 1500	600		
232	255		
95	AWG 4...250		
	8 kV / 3		
	/ V-0		



Rated connection

25...120 / 25...120
25...120 / 25...95
40 / 1.0 x 5.5 mm

If a cross-connection is mounted next to a PE terminal block or a terminal block for direct mounting, the rated voltage is reduced to 1000 V DC.

Type	Qty.	Order No.
A2C 95/120-DM	5	2694150000
A2C 95/120 BL-DM	5	2694160000

Type	Qty.	Order No.	
ZQV 95/120N/2	192 A	10	2694250000
ZQV 95/120N/3	192 A	10	2694260000
AAC 50-185 2X10	57 A	5	2663420000
AAC 50-185 2X10 BL	57 A	5	2663430000
AAC 50-185 2X10 BK-YL	57 A	5	2663450000
AAC 50-185 2X10 GN-YL	57 A	5	2663440000
ATPG 1.5-10 L	0.2 A	50	1991890000
PS 2.0 MC	20	0310000000	
SDS 1.0X5.5X150	1	2749380000	
AAM 35-185 YE FLASH	40	2635600000	
WS-A 8/16 MM WS	200	2619910000	

A2C 95/120 FE-DM

95 mm²

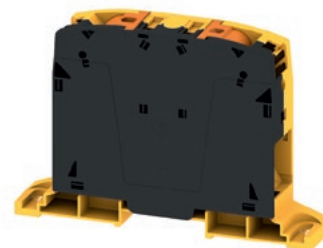

25 x 133.5 x 90
232 / 120
25...120

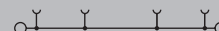

IEC 60947-7-1

IEC	UL	CSA	EN 60079-7
1000 / 1500			
232			
95	AWG 4...0		
	8 kV / 3		
	/ V-0		



Rated connection

25...120 / 25...120
25...120 / 25...95
40 / 1.0 x 5.5 mm

If a cross-connection is mounted next to a PE terminal block or a terminal block for direct mounting, the rated voltage is reduced to 1000 V DC.

Type	Qty.	Order No.
A2C 95/120 FE-DM	5	2694170000

Type	Qty.	Order No.	
ZQV 95/120N/2	192 A	10	2694250000
ZQV 95/120N/3	192 A	10	2694260000
AAC 50-185 2X10	57 A	5	2663420000
AAC 50-185 2X10 BL	57 A	5	2663430000
AAC 50-185 2X10 BK-YL	57 A	5	2663450000
AAC 50-185 2X10 GN-YL	57 A	5	2663440000
ATPG 1.5-10 L	0.2 A	50	1991890000
PS 2.0 MC	20	0310000000	
SDS 1.0X5.5X150	1	2749380000	
AAM 35-185 YE FLASH	40	2635600000	
WS-A 8/16 MM WS	200	2619910000	



**Power feed-in
PUSH IN connection**

Terminal blocks for rail mounting

A2C 150/185

150 mm²

A2C 150/185 FE

150 mm²



Q3
2023

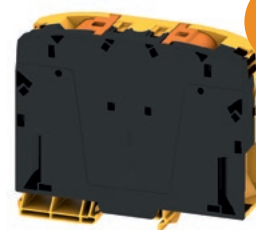

Q3
2023

Width/Height/Depth	mm
max. current / max. cond. cross-section	A/mm ²
Max. clamping range	mm ²

34 x 118.5 x 98
309 / 185
25...185

34 x 118.5 x 98
309 / 185
25...185

Technical data

Rated data	
Rated voltage	V/V DC
Rated current	A
for wire cross-section	mm ²
Rated impulse withstand voltage / Pollution severity	
Gauge to IEC 60947-1 / UL 94 flammability rating	
Approvals	
Clamped conductors (H05V/H07V)	
Solid / Stranded	mm ²
Flexible / Flexible with ferrule	mm ²
Stripping length / Blade size	mm/-
Note	

IEC 60947-7-1			
IEC	UL	CSA	EN 60079-7
1000 / 1500			
309			
150			
	8 kV / 3		
	B13 / V-0		
Rated connection			
50...185 / 50...185			
50...185 / 50...150			
40 / 1.0 x 5.5 mm			
If a cross-connection is mounted next to a PE terminal block or a terminal block for direct mounting, the rated voltage is reduced to 1000 V DC.			

IEC 60947-7-1			
IEC	UL	CSA	EN 60079-7
1000 / 1500			
309			
150			
	8 kV / 3		
	B13 / V-0		
Rated connection			
50...185 / 50...185			
50...185 / 50...150			
40 / 1.0 x 5.5 mm			

Ordering data

Version	
	dark beige
	Blue
	yellow/black
Note	

Type	Qty.	Order No.
A2C 150/185	5	2728700000
A2C 150/185 BL	5	2728710000

Type	Qty.	Order No.
A2C 150/185 FE	5	2728720000

Accessories

Cross connections insertable	
	2-pole
	3-pole
Additional tap	
	dark beige
	blue
	black/yellow
	green/yellow
End bracket	
	dark beige, screwable
	dark beige, direct mounting
Test adapter	
	1-pole
Test plug	
Screwdriver	
	Standard
Warning labels	
Marking tags	

Type	Qty.	Order No.
ZQV 150/185N/2	232 A	5 2728840000
ZQV 150/185N/3	232 A	5 2728850000
AAC 50-185 2X10	57 A	5 2663420000
AAC 50-185 2X10 BL	57 A	5 2663430000
AAC 50-185 2X10 BK-YL	57 A	5 2663450000
AAC 50-185 2X10 GN-YL	57 A	5 2663440000
AEB 35 SC/1	50	1991920000
AEB 35 SCL/1 V0	20	2661280000
ATPG 1.5-10 L	0.2 A	50 1991890000
PS 2.0 MC	20	0310000000
SDS 1.0X5.5X150	1	2749380000
AAM 35-185 YE FLASH	40	2635600000
WS-A 8/16 MM WS	200	2619910000

Type	Qty.	Order No.
ZQV 150/185N/2	232 A	5 2728840000
ZQV 150/185N/3	232 A	5 2728850000
AAC 50-185 2X10	57 A	5 2663420000
AAC 50-185 2X10 BL	57 A	5 2663430000
AAC 50-185 2X10 BK-YL	57 A	5 2663450000
AAC 50-185 2X10 GN-YL	57 A	5 2663440000
AEB 35 SC/1	50	1991920000
AEB 35 SCL/1 V0	20	2661280000
ATPG 1.5-10 L	0.2 A	50 1991890000
PS 2.0 MC	20	0310000000
SDS 1.0X5.5X150	1	2749380000
AAM 35-185 YE FLASH	40	2635600000
WS-A 8/16 MM WS	200	2619910000

For detailed information on other accessories and application in the online catalogue

A2C 150/185-DM

150 mm²



Q3
2023

34 x 151 x 98
309 / 185
25...185

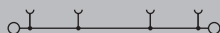

IEC 60947-7-1

IEC	UL	CSA	EN 60079-7
1000 / 1500			
309			
150			
	8 kV / 3		
	B13 / V-0		

Rated connection

50...185 / 50...185
50...185 / 50...150
40 / 1.0 x 5.5 mm

If a cross-connection is mounted next to a PE terminal block or a terminal block for direct mounting, the rated voltage is reduced to 1000 V DC.

Type	Qty.	Order No.
A2C 150/185-DM	1	2728770000
A2C 150/185 BL-DM	5	2728780000

Type	Qty.	Order No.
ZQV 150/185N/2	232 A	5 2728840000
ZQV 150/185N/3	232 A	5 2728850000
AAC 50-185 2X10	57 A	5 2663420000
AAC 50-185 2X10 BL	57 A	5 2663430000
AAC 50-185 2X10 BK-YL	57 A	5 2663450000
AAC 50-185 2X10 GN-YL	57 A	5 2663440000
ATPG 1.5-10 L	0.2 A	50 1991890000
PS 2.0 MC	20	0310000000
SDS 1.0X5.5X150	1	2749380000
AAM 35-185 YE FLASH	40	2635600000
WS-A 8/16 MM WS	200	2619910000

A2C 150/185 FE-DM

150 mm²

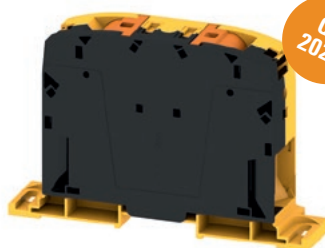

Q3
2023

34 x 151 x 98
309 / 185
25...185

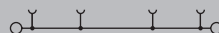

IEC 60947-7-1

IEC	UL	CSA	EN 60079-7
1000 / 1500			
309			
150			
	8 kV / 3		
	B13 / V-0		

Rated connection

50...185 / 50...185
50...185 / 50...150
40 / 1.0 x 5.5 mm

Type	Qty.	Order No.
A2C 150/185 FE-DM	5	2728790000

Type	Qty.	Order No.
ZQV 150/185N/2	232 A	5 2728840000
ZQV 150/185N/3	232 A	5 2728850000
AAC 50-185 2X10	57 A	5 2663420000
AAC 50-185 2X10 BL	57 A	5 2663430000
AAC 50-185 2X10 BK-YL	57 A	5 2663450000
AAC 50-185 2X10 GN-YL	57 A	5 2663440000
WEW 35/1	50	1059000000
ATPG 1.5-10 L	0.2 A	50 1991890000
PS 2.0 MC	20	0310000000
SDS 1.0X5.5X150	1	2749380000
AAM 35-185 YE FLASH	40	2635600000
WS-A 8/16 MM WS	200	2619910000



**Power feed-in
PUSH IN connection**

Application range

Terminal blocks for rail mounting



Width/Height/Depth	mm
max. current / max. cond. cross-section	A/mm ²
Max. clamping range	mm ²

Technical data

Rated data	
Rated voltage	V/V DC
Rated current	A
for wire cross-section	mm ²
Rated impulse withstand voltage / Pollution severity	
Gauge to IEC 60947-1 / UL 94 flammability rating	
Approvals	
Clamped conductors (H05V/H07V)	
Solid / Stranded	mm ²
Flexible / Flexible with ferrule	mm ²
Stripping length / Blade size	mm/-
Note	

Ordering data

Version	
Clamping range 50 mm² / 70 mm²	
	dark beige
	dark beige, blue
	dark beige, black/yellow
	dark beige, blue, black/yellow
Clamping range 95 mm² / 120 mm²	
	dark beige
	dark beige, blue
	dark beige, black/yellow
	dark beige, blue, black/yellow
Clamping range 150 mm² / 185 mm²	
	dark beige
	dark beige, blue
	dark beige, black/yellow
	dark beige, blue, black/yellow
Note	

Accessories

Additional tap	
	dark beige
	blue
	black/yellow
	green/yellow
End bracket	
	dark beige, screwable
Screwdriver	
	Standard
Warning labels	
Marking tags	

For detailed information on other accessories and application in the online catalogue

A2C ... 3FT

50 mm²



60 x 101.5 x 80.5	
150 / 70	
10...70	

IEC 60947-1			
IEC	UL	CSA	EN 60079-7
1000 / 1500	1000	1000	
150	175	175	
50	AWG 8...0	AWG 8...NaN	
8 kV / 3 / V-0			
Rated connection			
10...70 / 10...70			
10...70 / 10...50			
30 / 1.0 x 5.5 mm			
If a cross-connection is mounted next to a PE terminal block or a terminal block for direct mounting, the rated voltage is reduced to 1000 V DC.			

Type	Qty.	Order No.
A2C 50/70 3FT	1	2663320000
A2C 50/70 3FT-N	1	2663300000
A2C 95/120 3FT	1	2694140000
A2C 95/120 3FT-N	1	2694120000
A2C 150/185 3FT	1	2728760000
A2C 150/185 3FT-N	1	2728740000
You will find the technical data on the individual products.		

Type	Qty.	Order No.
AAC 50-185 2X10	57 A 5	2663420000
AAC 50-185 2X10 BL	57 A 5	2663430000
AAC 50-185 2X10 BK-YL	57 A 5	2663450000
AAC 50-185 2X10 GN-YL	57 A 5	2663440000
AEB 35 SC/1	50	1991920000
SDS 1.0X5.5X150	1	2749380000
AAM 35-185 YE FLASH	40	2635600000
WS-A 8/16 MM WS	200	2619910000

For detailed information on other accessories and application in the online catalogue

A2C ... 3FT-FE

50 mm²



80 x 101.5 x 80.5	
150 / 70	
10...70	

IEC 60947-1			
IEC	UL	CSA	EN 60079-7
1000 / 1500	1000	1000	
150	175	175	
50	AWG 8...0	AWG 8...NaN	
8 kV / 3 / V-0			
Rated connection			
10...70 / 10...70			
10...70 / 10...50			
30 / 1.0 x 5.5 mm			
If a cross-connection is mounted next to a PE terminal block or a terminal block for direct mounting, the rated voltage is reduced to 1000 V DC.			

Type	Qty.	Order No.
A2C 50/70 3FT-FE	1	2663310000
A2C 50/70 3FT-N-FE	1	2663290000
A2C 95/120 3FT-FE	1	2694130000
A2C 95/120 3FT-N-FE	1	2694100000
A2C 150/185 3FT-FE	1	2728750000
A2C 150/185 3FT-N-FE	5	2728730000
You will find the technical data on the individual products.		

Type	Qty.	Order No.
AAC 50-185 2X10	57 A 5	2663420000
AAC 50-185 2X10 BL	57 A 5	2663430000
AAC 50-185 2X10 BK-YL	57 A 5	2663450000
AAC 50-185 2X10 GN-YL	57 A 5	2663440000
AEB 35 SC/1	50	1991920000
SDS 1.0X5.5X150	1	2749380000
AAM 35-185 YE FLASH	40	2635600000
WS-A 8/16 MM WS	200	2619910000

For detailed information on other accessories and application in the online catalogue

A2C ... 3FT DM

50 mm²



60 x 134 x 80.5
150 / 70
10...70

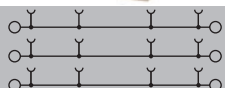

IEC 60947-7-1

IEC	UL	CSA	EN 60079-7
1000 / 1500	1000	1000	
150	175	175	
50	AWG 8...0	AWG 8...NaN	
8 kV / 3 / V-0			



Rated connection

10...70 / 10...70
10...70 / 10...50
30 / 1.0 x 5.5 mm

If a cross-connection is mounted next to a PE terminal block or a terminal block for direct mounting, the rated voltage is reduced to 1000 V DC.

Type	Qty.	Order No.
A2C 50/70 3FT-DM	1	2663390000
A2C 50/70 3FT-N-DM	1	2663370000
A2C 95/120 3FT-DM	1	2694230000
A2C 95/120 3FT-N-DM	1	2694200000
A2C 150/185 3FT-DM	1	2728830000
A2C 150/185 3FT-N-DM	1	2728810000
You will find the technical data on the individual products.		

Type	Qty.	Order No.	
AAC 50-185 2X10	57 A	5	2663420000
AAC 50-185 2X10 BL	57 A	5	2663430000
AAC 50-185 2X10 BK-YL	57 A	5	2663450000
AAC 50-185 2X10 GN-YL	57 A	5	2663440000
SDS 1.0X5.5X150	1	2749380000	
AAM 35-185 YE FLASH	40	2635600000	
WS-A 8/16 MM WS	200	2619910000	

A2C ... 3FT-FE DM

50 mm²

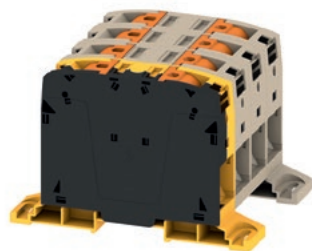

80 x 134 x 80.5
150 / 70
10...70

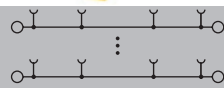

IEC 60947-7-1

IEC	UL	CSA	EN 60079-7
1000 / 1500	1000	1000	
150	175	175	
50	AWG 8...0	AWG 8...NaN	
8 kV / 3 / V-0			



Rated connection

10...70 / 10...70
10...70 / 10...50
30 / 1.0 x 5.5 mm

If a cross-connection is mounted next to a PE terminal block or a terminal block for direct mounting, the rated voltage is reduced to 1000 V DC.

Type	Qty.	Order No.
A2C 50/70 3FT-FE-DM	1	2663380000
A2C 50/70 3FT-N-FE-DM	1	2663360000
A2C 95/120 3FT-FE-DM	1	2694220000
A2C 95/120 3FT-N-FE-DM	1	2694180000
A2C 150/185 3FT-FE-DM	1	2728820000
A2C 150/185 3FT-N-FE-DM	5	2728800000
You will find the technical data on the individual products.		

Type	Qty.	Order No.	
AAC 50-185 2X10	57 A	5	2663420000
AAC 50-185 2X10 BL	57 A	5	2663430000
AAC 50-185 2X10 BK-YL	57 A	5	2663450000
AAC 50-185 2X10 GN-YL	57 A	5	2663440000
SDS 1.0X5.5X150	1	2749380000	
AAM 35-185 YE FLASH	40	2635600000	
WS-A 8/16 MM WS	200	2619910000	



Mounting in compliance with norms

Thanks to precisely matched accessories for the A2C 50/70 to A2C 150/185

When assembling terminal blocks and equipping panels you must be able to rely on the fact, that the accessories are also perfectly matched. Only then can the processes run smoothly and productively. Correspondingly there are high requirements for mounting rails, cross-connections and cover plates as well as additional connections. They must comply with numerous norms and protective provisions.

The comprehensive accessories of the Klippon® Connect portfolio are perfectly matched down to the last detail. This facilitates mounting while adhering to required norms.

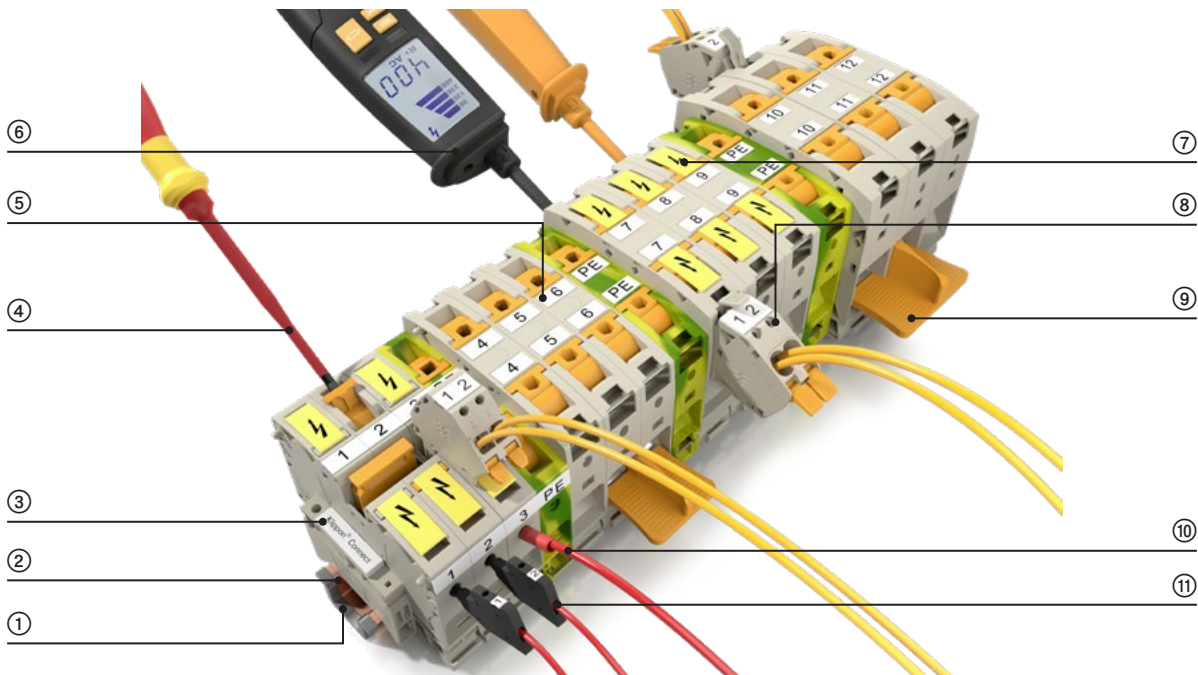

Number	Description	Type	Rated voltage	Rated Current	Dimensions	Colour	Qty.	Order No.
1	End cap mounting rail	TS END CAP 35X15			37.5 x 16.5 x 7 mm	grey	100	1283480000
2	Mounting rail	TS 35X15/2.3M/CU/BK			35 x 15 x 2000 mm		2	0270100000
3	End brackets	AEB 35 SC/1			8 x 58 x 36 mm	dark beige	50	1991920000
4	Screwdriver	SDS 1.0X5.5X150			1.0 x 5.5 x 150 mm	black/orange	1	2749380000
5	Terminal block marker	WS-A 8/16 MM WS			8 x 16 mm	white	200	2619910000
6	Voltage tester	VT DIGI PRO	1000 V AC / 1000 V DC		264 x 33 x 67 mm	black/orange	1	9918870000
7	Flash cover	AAM 35-185 YE FLASH			12 x 23.5 x 6.8 mm	yellow	40	2635600000
8	Additional voltage tap	AAC 50-185 2X10	1000 V AC / 1500 V DC	57 A	20 x 50.5 x 42.5 mm	dark beige	5	2663420000
8	Additional voltage tap	AAC 50-185 2X10 BL	1000 V AC / 1500 V DC	57 A	20 x 50.5 x 42.5 mm	blue	5	2663430000
8	Additional voltage tap	AAC 50-185 2X10 BK-YL	1000 V AC / 1500 V DC	57 A	20 x 50.5 x 42.5 mm	black/yellow	5	2663450000
8	Additional voltage tap	AAC 50-185 2X10 GN-YL	1000 V AC / 1500 V DC	57 A	20 x 50.5 x 42.5 mm	green/yellow	5	2663440000
9	Cross connection	ZQV 150/185N/2	1000 V AC / 1500 V DC	232 A	88.32 x 82.26 x 25.6 mm	orange	5	2728840000
9	Cross connection	ZQV 150/185N/3	1000 V AC / 1500 V DC	232 A	57.32 x 82.26 x 25.6 mm	orange	5	2728850000
9	Cross connection	ZQV 95/120N/2	1000 V AC / 1500 V DC	232 A	48.07 x 76.91 x 22.5 mm	orange	10	2694250000
9	Cross connection	ZQV 95/120N/3	1000 V AC / 1500 V DC	232 A	73.07 x 76.91 x 22.5 mm	orange	10	2694260000
9	Cross connection	ZQV 50/70N/2	1000 V AC / 1500 V DC	150 A	38.13 x 68.18 x 17.1 mm	orange	10	2663400000
10	Test probe	PS 2.0 MC	250 V AC / 250 V DC	0.2 A	4.3 x 4.3 x 27 mm	red	20	0310000000
11	Test probe	ATPG 1.5-10 L	250 V AC / 250 V DC	0.2 A	3.5 x 15.5 x 52 mm	black	50	1991890000



WDU 35 IR

35 mm²

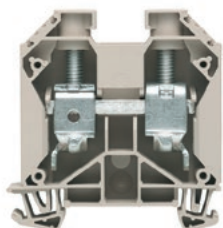

16 x 60 x 62.5
150 / 50
2.5...50



IEC 60947-7-1 Ex eb II C Gb II 2 G D

IEC	UL	CSA	EN 60079-7
1000	1000		690
125	150		115
35	AWG 12...0		35 mm ²
8 kV / 3			
B8 / V-0			

DEMKO14ATEX1338U

Rated connection	Further connection
2.5...16 / 2.5...50	
2.5...35 / 2.5...35	
4...5 / (M 6)	
18 / TX 20	

Type	Qty.	Order No.
WDU 35 IR	40	1393400000

Type	Qty.	Order No.
WQV 35/2	138 A 50	1053060000
WQV 35/10	112 A 10	1053160000
WAP 16+35 WTW 2.5-10	20	1050100000
WAP 16+35 WTW 2.5-10 BL	20	1050180000
WEW 35/1	50	1059000000
WAD 12 MC B GE/SW	32	2445090000
WAD 12 MC NE WS	32	2445070000
DEK 5/5 MC NE WS	1000	1609801044
WS 12/5 MC NE WS	720	1609860000

WDU 35 IK

35 mm²

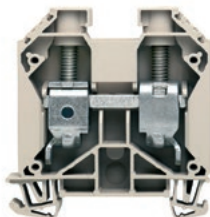

16 x 60 x 62.5
150 / 50
2.5...50



IEC 60947-7-1 Ex eb II C Gb II 2 G D

IEC	UL	CSA	EN 60079-7
1000	600	600	690
125	150	150	115
35	AWG 12...NaN	AWG 12...NaN	35 mm ²
8 kV / 3			
B8 / V-0			

DEMKO14ATEX1338U

Rated connection	Further connection
2.5...16 / 2.5...50	
2.5...35 / 2.5...35	
4...6 / (M 6)	
18 / S4 (DIN 6911)	

/ 16...16	
2.5...16 / 2.5...16	

Type	Qty.	Order No.
WDU 35/IK	25	1020600000

Type	Qty.	Order No.
WQV 35/2	138 A 50	1053060000
WQV 35/10	112 A 10	1053160000
WAP 16+35 WTW 2.5-10	20	1050100000
WAP 16+35 WTW 2.5-10 BL	20	1050180000
WEW 35/1	50	1059000000
WAD 12 MC B GE/SW	32	2445090000
WAD 12 MC NE WS	32	2445070000
DEK 5/5 MC NE WS	1000	1609801044
WS 12/6.5 MC NE WS	540	1609920000

WDU 50N

50 mm²



18.5 x 70 x 69.6
192 / 70
10...70



IEC 60947-7-1 Ex eb II C Gb II 2 G D

IEC	UL	CSA	EN 60079-7
1000	600	600	690
150	150	150	126
50	AWG 10...0	AWG 8...0	50 mm ²
8 kV / 3			
B10 / V-0			

DEMKO14ATEX1338U

Rated connection	Further connection
10...16 / 10...70	
10...50	
3.5...6 / (M 6)	
24 / S4 (DIN 6911)	

/ 6...16	
6...16 / 6...16	

Type	Qty.	Order No.
WDU 50N	10	1820840000
WDU 50N BL	10	1820850000

Type	Qty.	Order No.
WQV 50N/2	150 A 5	1834060000
WQV 50N/4	150 A 5	1834080000
WQV 50N/3	150 A 5	1834070000
WEW 35/1	50	1059000000
WAD 20 GE WSD	10	9512260000
DEK 5/5 MC NE WS	1000	1609801044
WS 12/6.5 MC NE WS	540	1609920000
WZAD 50N	41 A 5	1872720000
SKS 2,0-8,0 MR	1	9008870000



Power feed-in
Screw connection



Width/Height/Depth	mm
max. current / max. cond. cross-section	A/mm ²
Max. clamping range	mm ²

Technical data

Rated data	
Rated voltage	V
Rated current	A
for wire cross-section	mm ²
Rated impulse withstand voltage / Pollution severity	
Gauge to IEC 60947-1 / UL 94 flammability rating	
Approvals	
Clamped conductors (H05V/H07V)	
Solid / Stranded	mm ²
Flexible / Flexible with ferrule	mm ²
Tightening torque / Clamping screw	Nm
Stripping length / Blade size	mm/-
2 conductors with same cross-section (H05V/H07V)	
Solid / Stranded	-
Flexible / Flexible with ferrule	mm ²
Note	

Ordering data

Version	
	dark beige
	Blue
	without peg / dark beige
Note	

Accessories

Screwable cross-connection	
	2-pole
	10-pole
	4-pole
	3-pole
End plate / Partition plate	
	dark beige
	Blue
End bracket	
	dark beige, screwable
	dark beige
Cover	
	black/yellow
	white
	With lightning flash symbol
	Blank, white
Marking tags	
Additional connection	
	10 mm ²
	4mm ²
Screwdriver	
	Standard

For detailed information on other accessories and application in the online catalogue

WDU 50N IR

50 mm²

Six-lobe socket



18.5 x 70 x 69.6
192 / 70
10...70

IEC 60947-7-1 Ex eb II C Gb II 2 G D

IEC	UL	CSA	EN 60079-7
1000			690
192			126
50			50 mm ²
8 kV / 3			
B10 / V-0			

DEMKO14ATEX1338U

Rated connection	Further connection
10...16 / 10...70	
10...50	
3...6 / (M 6)	
24 / TX 20	
/ 6...16	
6...16 / 6...16	

Type	Qty.	Order No.
WDU 50N IR	10	1186630000

Type	Qty.	Order No.
WQV 50N/2	150 A 5	1834060000
WQV 50N/4	150 A 5	1834080000
WQV 50N/3	150 A 5	1834070000

Type	Qty.	Order No.
WEW 35/1	50	1059000000

Type	Qty.	Order No.
WAD 20 GE WSD	10	9512260000

Type	Qty.	Order No.
DEK 5/5 MC NE WS	1000	1609801044
WS 12/6.5 MC NE WS	540	1609920000

Type	Qty.	Order No.
WZAD 50N	41 A 5	1872720000

Type	Qty.	Order No.
THS 9-40	1	9008880000

For detailed information on other accessories and application in the online catalogue

WDU 70N

70 mm²

Compact design

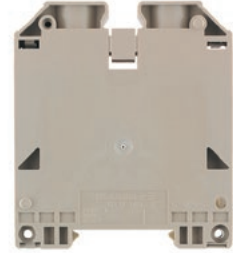

20.5 x 75 x 85
232 / 95
16...95

IEC 60947-7-1 Ex eb II C Gb II 2 G D

IEC	UL	CSA	EN 60079-7
1000	600	600	690
192	150	150	184
70	AWG 6...0	AWG 6...0	70 mm ²
8 kV / 3			
B11 / V-0			

DEMKO14ATEX1338U

Rated connection	Further connection
16...16 / 16...95	
16...70 / 16...50	
8...12 / (M 8)	
22 / S6 (DIN 6911)	
/ 10...25	
10...25 / 6...25	

Type	Qty.	Order No.
WDU 70N/35	10	9512190000
WDU 70N/35 BL	10	9512420000

Type	Qty.	Order No.
WQV 70N/2	192 A 5	9512240000
WQV 70N/4	192 A 5	9531290000
WQV 70N/3	192 A 5	9512250000

Type	Qty.	Order No.
WEW 35/1	50	1059000000

Type	Qty.	Order No.
WAD 20 GE WSD	10	9512260000

Type	Qty.	Order No.
DEK 5/5 MC NE WS	1000	1609801044
WS 12/6.5 MC NE WS	540	1609920000

Type	Qty.	Order No.
WZAD 70N	41 A 5	1964830000

Type	Qty.	Order No.
SKS 2,0-8,0 MR	1	9008870000

For detailed information on other accessories and application in the online catalogue

WDU 70N IR

70 mm²

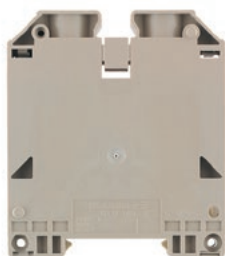

20.5 x 75 x 85
232 / 95
16...95



IEC 60947-7-1

IEC	UL	CSA	EN 60079-7
1000	600		
192	150		
70	AWG 6...0		
8 kV / 3			
B11 / V-0			



Rated connection	Further connection
16...16 / 16...95	
16...70 / 16...50	
8...12 / (M 8)	
22 / TX 40	

Type	Qty.	Order No.
WDU 70N/35 IR	10	1393420000

Type	Qty.	Order No.
WQV 70N/2	192 A 5	9512240000
WQV 70N/4	192 A 5	9531290000
WQV 70N/3	192 A 5	9512250000
WEW 35/1	50	1059000000
WAD 20 GE WSD	10	9512260000
DEK 5/5 MC NE WS	1000	1609801044
WS 12/5 MC NE WS	720	1609860000
WZAD 70N	41 A 5	1964830000
TH-S 9-40	1	9008880000

WDU 70/95

95 mm²

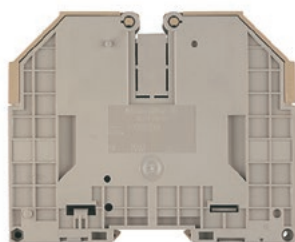

27 x 132 x 107
232 / 120
13.3...120



IEC 60947-7-1

IEC	UL	CSA	EN 60079-7
1000	1000	600	1100
232	175	205	218
95	AWG 6...0	AWG 6...0	95 mm ²
8 kV / 3			
B12 / V-0			

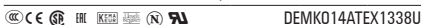

Rated connection	Further connection
16...16 / 16...120	
16...95 / 16...50	
6...12 / (M 8)	
30 / S6 (DIN 6911)	

/ 16...35
16...35 / 16...35

Type	Qty.	Order No.
WDU 70/95	10	1024600000
WDU 70/95 BL	10	1024680000

Type	Qty.	Order No.
WQV 70/95/2	232 A 5	1063500000
WQV 70/95/3	232 A 5	1063600000
WEW 35/1	50	1059000000
WAD 27 M. BL	10	1062860000
WAD 27 NEUTRAL	10	1062960000
DEK 5/5 MC NE WS	1000	1609801044
WS 12/6.5 MC NE WS	540	1609920000
WZAD 70/95	32 A 10	1066000000
SKS 2,0-8,0 MR	1	9008870000

WDU 95N/120N

120 mm²



27 x 91 x 90
290 / 150
16...150



IEC 60947-7-1

IEC	UL	CSA	EN 60079-7
1000	1000	1000	880
269	228	220	221
120	AWG 4...250	AWG 4...0	120 mm ²
8 kV / 3			
B13 / V-0			

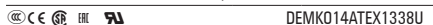

Rated connection	Further connection
16...16 / 16...150	
16...120	
12...20 / (M 10)	
27 / S6 (DIN 6911)	

35...10 / 10...35
16...35 / 10...35

Type	Qty.	Order No.
WDU 95N/120N	5	1820550000
WDU 95N/120N BL	5	1820560000

Type	Qty.	Order No.
WQV 95N/120N/2	269 A 5	1826890000
WQV 95N/120N/4	269 A 5	1826910000
WQV 95N/120N/3	269 A 5	1826900000
WEW 35/1	50	1059000000
WAD 20 GE WSD	10	9512260000
DEK 5/5 MC NE WS	1000	1609801044
WS 12/6.5 MC NE WS	540	1609920000
WZAD 95N/120N	41 A 5	1859580000
SKS 2,0-8,0 MR	1	9008870000



Power feed-in
Screw connection



WDU 120/150

120 mm²

Conductor can be inserted from above / leaf spring

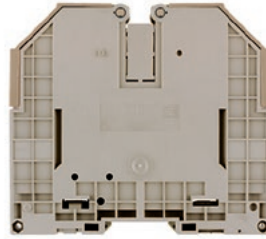

WDU 240

240 mm²



Width/Height/Depth	mm
max. current / max. cond. cross-section	A/mm ²
Max. clamping range	mm ²

32 x 132 x 117
309 / 150
33.63...150

36 x 100 x 123.7
415 / 240
70...240

Technical data

Rated data	
Rated voltage	V
Rated current	A
for wire cross-section	mm ²
Rated impulse withstand voltage / Pollution severity	
Gauge to IEC 60947-1 / UL 94 flammability rating	
Approvals	
Clamped conductors (H05V/H07V)	
Solid / Stranded	-
Flexible / Flexible with ferrule	mm ²
Tightening torque / Clamping screw	Nm
Stripping length / Blade size	mm/-
2 conductors with same cross-section (H05V/H07V)	
Solid / Stranded	-
Flexible / Flexible with ferrule	mm ²
Note	

IEC 60947-7-1			
Ex eb II C Gb II 2 G D			
IEC	UL	CSA	EN 60079-7
1000	1000	600	1100
269	225	285	265
120	AWG 2...250	AWG 2...250	150 mm ²
8 kV / 3			
B13 / V-0			
DEMKD14ATEX1338U			
Rated connection		Further connection	
/ 35...150			
35...150 / 35...50			
10...20 / (M 10)			
35 / S6 (DIN 6911)			
/ 35...70			
35...70 / 35...70			

IEC 60947-7-1			
Ex e II II 2 G D			
IEC	UL	CSA	EN 60079-7
1000	600	600	1100
415	380	400	350
240		AWG 0...500	240 mm ²
8 kV / 3			
B15 / V-0			
KEMA01ATEX2186U			
Rated connection		Further connection	
/ 70...240			
70...240 / 70...185			
25...30 / (M 10)			
40 / S8 (DIN 6911)			
/ 35...95			
50...95 / 35...50			

Ordering data

Version	
	dark beige
	Blue
	without peg / dark beige
Note	

Type	Qty.	Order No.
WDU 120/150	10	1024500000
WDU 120/150 BL	10	1024580000

Type	Qty.	Order No.
WDU 240	2	1802780000
WDU 240 BL	2	1822210000

Accessories

Screwable cross-connection	
	2-pole
	10-pole
	4-pole
	3-pole
End plate / Partition plate	
	dark beige
	Blue
End bracket	
	dark beige, screwable
	dark beige
Cover	
	black/yellow
	white
	With lightning flash symbol
	Blank, white
Marking tags	
Additional connection	
	10 mm ²
	4mm ²
Screwdriver	
	Standard
For detailed information on other accessories and application in the online catalogue	

Type	Qty.	Order No.
WQV 120/2	269 A 5	1063300000
WQV 120/3	292 A 5	1063400000
WEW 35/1	50	1059000000
WAD 27 M. BL.	10	1062860000
WAD 27 NEUTRAL	10	1062960000
DEK 5/5 MC NE WS	1000	1609801044
WS 12/6.5 MC NE WS	540	1609920000
WZAD 120	10	1066100000
SKS 2,0-8,0 MR	1	9008870000

Type	Qty.	Order No.
WQB 240/2	320 A 5	1802790000
WQB 240/3	320 A 5	1802800000
WEW 35/1	50	1059000000
DEK 5/5 MC NE WS	1000	1609801044
WS 12/6.5 MC NE WS	540	1609920000
WZAD 240	57 A 5	1802810000
SKS 2,0-8,0 MR	1	9008870000



Power feed-in
Screw connection



WPE 35

35 mm²

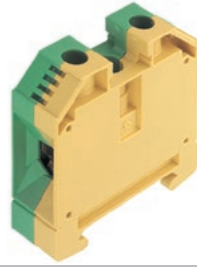

WPE 35N

35 mm²

Compact design



Width/Height/Depth	mm
max. current / max. cond. cross-section	-/mm ²
Max. clamping range	mm ²

16 x 56 x 62.5	
/ 35	
2.5...35	

16 x 66 x 50.5	
/ 50	
2.5...50	

Technical data

Rated data	
for wire cross-section	mm ²
Rated voltage to adjoining terminal	V
Rated impulse withstand voltage to adjacent terminal	kV
Rated short-time current	
Pollution severity	
Gauge to IEC 60947-1 / UL 94 flammability rating	
Approvals	

IEC 60947-7-2

IEC	UL	CSA	EN 60079-7
35	AWG 12...2	AWG 12...2	35 mm ²
800			
8			
4200 A (35 mm ²)			
3			
B8 / V-0			

Ex eb II
C Gb II 2 G D

IEC 60947-7-2

IEC	UL	CSA	EN 60079-7
35	AWG 12...2		35 mm ²
400			
6			
4200 A (35 mm ²)			
3			
B8 / V-0			

Ex eb II
C Gb II 2 G D

Clamped conductors (H05V/H07V)

Solid / Stranded	mm ²
Flexible / Flexible with ferrule	mm ²
Tightening torque / Clamping screw	Nm
Tightening torque for fixing screw	
Stripping length / Blade size	mm

Rated connection	
2.5...50 / 2.5...50	
2.5...35 / 2.5...35	
4...5 / (M 6)	
1.2...2.4 Nm	
18 / 6.5 x 1.2 mm	

Rated connection	
2.5...16 / 2.5...50	
2.5...35 / 2.5...35	
4...5 / (M 6)	
1.2...2.4 Nm	
18 / 6.5 x 1.2 mm	

Note

Ordering data

Version	Green/yellow green/yellow
Note	

Type	Qty.	Order No.
WPE 35	25	1010500000

Type	Qty.	Order No.
WPE 35N	20	1717740000

Accessories

PEN bridge	
End bracket	dark beige, screwable dark beige
Screwdriver	Standard
Marking tags	

Type	Qty.	Order No.
WQB-PEN 35	135 A	1060100000
WEW 35/1	50	1059000000
SDS 1.2X6.5X150	1	2749390000
DEK 5/5 MC NE WS	1000	1609801044
WS 12/6.5 MC NE WS	540	1609920000

Type	Qty.	Order No.
WEW 35/2	50	1061200000
SDS 1.2X6.5X150	1	2749390000
DEK 5/5 MC NE WS	1000	1609801044
WS 12/6.5 MC NE WS	540	1609920000

For detailed information on other accessories and application in the online catalogue

WPE 35/IKSC

35 mm²

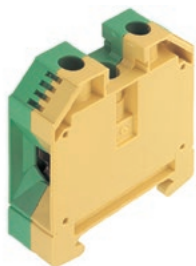

16 x 56 x 62.5
/ 35
2.5...35

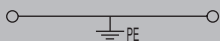

IEC 60947-7-2 Ex eb II C Gb II 2 G D

IEC	UL	CSA	EN 60079-7
35	AWG 12...1	AWG 12...2	35 mm ²
800			
8			
4200 A (35 mm ²)			
3			
B8 / V-0			

Rated connection

2.5...16 / 2.5...35
2.5...35 / 2.5...35
5 / (M 6)
1.2...2.4 Nm
18 / S4 (DIN 6911)

WPE 50N

50 mm²



18.5 x 71 x 69.6
/ 70
5.26...70



IEC 60947-7-2 Ex eb II C Gb II 2 G D

IEC	UL	CSA	EN 60079-7
50	AWG 10...0	AWG 14...0	50 mm ²
1000			
8			
6000 A (50 mm ²)			
3			
B10 / V-0			

Rated connection

10...16 / 10...70
10...50
4...6 / (M 6)
3.0...4.0 Nm
24 / S4 (DIN 6911)

WPE 70N/35

70 mm²



20.5 x 75 x 85
/ 95
16...95



IEC 60947-7-2 Ex eb II C Gb II 2 G D

IEC	UL	CSA	EN 60079-7
70	AWG 6...0	AWG 6...0	70 mm ²
1000			
8			
8400 A (70 mm ²)			
3			
B11 / V-0			

Rated connection

16...16 / 16...95
16...70 / 16...50
8...12 / (M 8)
2.0...4.0 Nm
22 / S6 (DIN 6911)

Type	Qty.	Order No.
WPE 35/IKSC	25	1012600000

Type	Qty.	Order No.
WPE 50N	10	1846040000

Type	Qty.	Order No.
WPE 70N/35	10	9512200000

Type	Qty.	Order No.
WQB-PEN 35	135 A 10	1060100000
WEW 35/1	50	1059000000
SDS 1.2X6.5X150	1	2749390000
DEK 5/5 MC NE WS	1000	1609801044
WS 12/6.5 MC NE WS	540	1609920000

Type	Qty.	Order No.
WQV PEN 50N	150 A 5	9201610000
WEW 35/1	50	1059000000
SKS 2,0-8,0 MR	1	9008870000
DEK 5/8 MC NE WS	800	1856740000
WS 12/6.5 MC NE WS	540	1609920000

Type	Qty.	Order No.
WQV 70N-PEN	192 A 5	9525840000
WEW 35/1	50	1059000000
SKS 2,0-8,0 MR	1	9008870000
DEK 5/5 MC NE WS	1000	1609801044
WS 12/6.5 MC NE WS	540	1609920000





Width/Height/Depth	mm
max. current / max. cond. cross-section	-/mm ²
Max. clamping range	mm ²

Technical data

Rated data	
for wire cross-section	mm ²
Rated voltage to adjoining terminal	V
Rated impulse withstand voltage to adjacent terminal	kV
Rated short-time current	
Pollution severity	
Gauge to IEC 60947-1 / UL 94 flammability rating	
Approvals	
Clamped conductors (H05V/H07V)	
Solid / Stranded	mm ²
Flexible / Flexible with ferrule	mm ²
Tightening torque / Clamping screw	Nm
Tightening torque for fixing screw	
Stripping length / Blade size	mm

Note

Ordering data

Version	
	Green/yellow green/yellow
Note	

Accessories

Accessories	
PEN bridge	
End bracket	dark beige, screwable dark beige
Screwdriver	Standard
Marking tags	

For detailed information on other accessories and application in the online catalogue

WPE 95N/120N

95 mm²

Compact design



27 x 91 x 90	
/ 150	
16...150	

IEC 60947-7-2			
IEC	UL	CSA	EN 60079-7
95	AWG 4...0	AWG 4...0	120 mm ²
1000			
8			
11400 A (95 mm ²)			
3			
B13 / V-0			
© CE ENEC TÜV ENEC			
Rated connection			
16...16 / 16...150			
16...120			
16...20 / (M 10)			
3.0...4.0 Nm			
27 / S6 (DIN 6911)			

Type	Qty.	Order No.
WPE 95N/120N	5	1846030000

Type	Qty.	Order No.	
WQV PEN 95N/120N	269 A	5	9201630000
WEW 35/1	50	1059000000	
SKS 2,0-8,0 MR	1	9008870000	
DEK 5/5 MC NE WS	1000	1609801044	
WS 12/6.5 MC NE WS	540	1609920000	

For detailed information on other accessories and application in the online catalogue

WPE 70/95

95 mm²

Conductor can be inserted from above / leaf spring

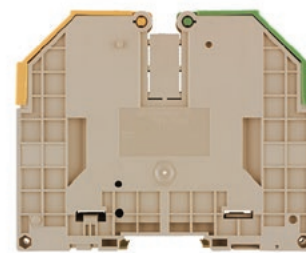

27 x 132 x 107	
/ 120	
13.3...120	

IEC 60947-7-2			
IEC	UL	CSA	EN 60079-7
95	AWG 6...0	AWG 6...0	95 mm ²
1000			
8			
11400 A (95 mm ²)			
3			
B12 / V-0			
© CE ENEC TÜV ENEC			
Rated connection			
16...16 / 16...120			
16...95 / 35...50			
6...12 / (M 8)			
3.0...6.0 Nm			
30 / S6 (DIN 6911)			

Type	Qty.	Order No.
WPE 70/95	10	1037300000

Type	Qty.	Order No.	
WQV 70/95-PEN	232 A	5	1072300000
WEW 35/1	50	1059000000	
SKS 2,0-8,0 MR	1	9008870000	
DEK 5/5 MC NE WS	1000	1609801044	
WS 12/6.5 MC NE WS	540	1609920000	

For detailed information on other accessories and application in the online catalogue

WPE 120/150

120 mm²

Conductor can be inserted from above / leaf spring

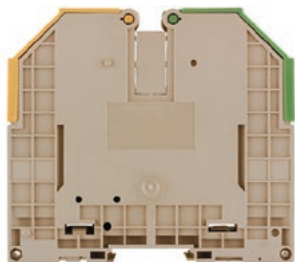

32 x 132 x 117
/ 150
33.62...150

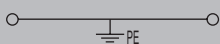

IEC 60947-7-2 Ex eb II C Gb II 2 G D

IEC	UL	CSA	EN 60079-7
120	AWG 2...250	AWG 2...250	150 mm ²
1000			
8			
	14400 A (120 mm ²)		
	3		
	B13 / V-0		

Rated connection

/ 35...150
35...150 / 35...50
10...20 / (M 10)
3.0...6.0 Nm
35 / S6 (DIN 6911)

Type	Qty.	Order No.
WPE 120/150	10	1019700000

Type	Qty.	Order No.	
WQV 120-PEN	292 A	5	1072400000
WEW 35/1	50	1059000000	
SKS 2,0-8,0 MR	1	9008870000	
DEK 5/5 MC NE WS	1000	1609801044	
WS 12/6.5 MC NE WS	540	1609920000	



Reliable and efficient power supply Really convenient with Klippon® Connect

A growing number of industrial applications needs to fit a large amount of technology into a very dense space. Different connection types must thereby be interchangeable, because cost-saving aluminium often replaces copper.

Klippon® Connect power feed-in terminal blocks WPD allow for an easy and safe installation of aluminium and copper conductors on a small footprint. A power supply or monitoring connection can also be used as an option.

Customers can use the power feed-in terminal blocks WPD, regardless of the conductor material. They can be mounted either directly or on DIN rail TS35.



B



Compact and robust design

Klippon® Connect power feed-in terminal blocks WPD boast a wide range of features, including a compact and robust design.



Uninterrupted monitoring

Small power supply and monitoring connections can be installed without disconnecting any previously connected terminal blocks.

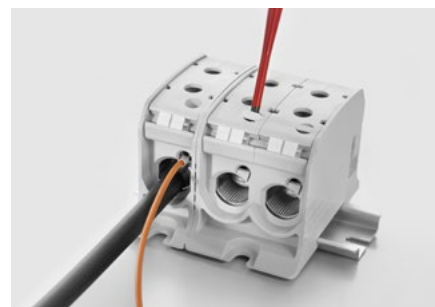

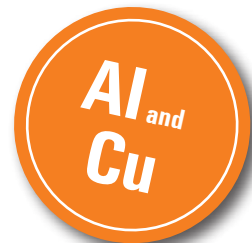

Easy and flexible mounting

The possibility of direct mounting and the compatibility with the 35-mm DIN rail in accordance with EN 60715 and EN 50022 allow fast processing and installation.

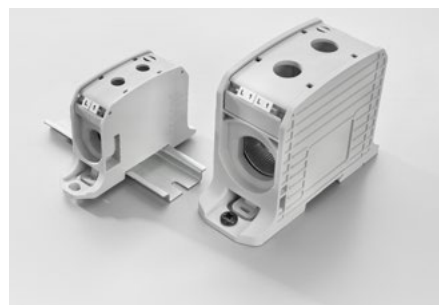

Socket wrench sets

Weidmüller offers fitting SK WSD-S Allen keys DIN ISO 2936 L (DIN 911) made from fully hardened high-alloy chromium-vanadium-steel with a high-quality refined surface for the blocks.

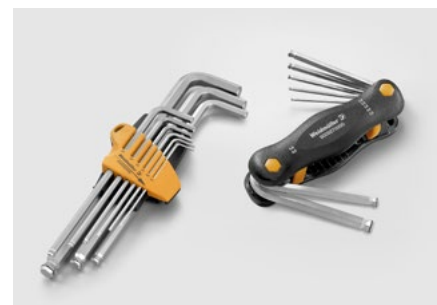

Power feed-in
Screw connection

W-Series
WPD 130 1X50/1X50



Width / Height / Depth	mm
max. current / max. conductor	A/mm ²
max. clamping range	mm ²

Technical data

Rated data	
Rated voltage	V
Rated current	A
for wire cross-section	mm ²
Rated impulse withstand voltage / Pollution severity	
Overvoltage category / UL 94 flammability rating	
Approvals	
Clamped conductors (H05V/H07V)	
Solid / Stranded	mm ²
Flexible with ferrule	mm ²
Stripping length / Blade size	mm/-
Tightening torque	Nm
Note	

Ordering data

Version	
	light grey
	blue
	green
	brown
	black
	brown / black / light grey
	green / light grey / blue
Note	

Accessories

Protective cover	light grey
End bracket	grey black
Screwdriver	SET
Identification systems	

WPD 130

50 mm²



22 / 45 / 70	
150 / 50	50 mm ² 50 mm ²
2.5...50	

IEC 60947-7-1

Ex II 2 GD
Ex eb IIC Gb

IEC	UL	CSA	EN 60079-7
1000	1000		880
150	150		150
50	AWG 12...1/0		50
8 kV / 3			
III / V-0			
CE, UL, CSA, UK, Ex, CNEX18ATEX0016U			
Rated connection			
2.5...50 / 2.5...50			
2.5...35			
16 / M10 (SW 5 mm)			
see appendix at the end of the chapter			

Type	Qty.	Order No.
WPD 130 1X50/1X50 GY	9	2502530000
WPD 130 1X50/1X50 BL	9	2502540000
WPD 130 1X50/1X50 GN	9	2502550000
WPD 130 1X50/1X50 BN	9	2502560000
WPD 130 1X50/1X50 BK	9	2502570000

Type	Qty.	Order No.
WPDPC X30 GY	54	2503330000
WEW 35/2 GR 7042	100	1859200000
AEB 35 SC/1 BK	50	2475310000
SK WSD-S 1,5-10,0	1	9008850000
DEK 5/5 MC NE WS	1000	1609801044
WS 8/5 MM WS	800	2007150000

WPD 230

50 mm²



35.6 / 45 / 70	
150 / 50	50 mm ² 50 mm ² 50 mm ² 50 mm ²
4...50	

IEC 60947-7-1

Ex II 2 GD
Ex eb IIC Gb

IEC	UL	CSA	EN 60079-7
1000	1000		880
150	150		150
50	AWG 12...1/0		50
8 kV / 3			
III / V-0			
CE, UL, CSA, UK, Ex, CNEX18ATEX0016U			
Rated connection			
6...50 / 6...50			
4...35			
16 / M10 (SW 5 mm)			
see appendix at the end of the chapter			
Imax: 300 A with the connection of 4 x 50 mm ²			

Type	Qty.	Order No.
WPD 230 2X50/2X50 GY	5	2502580000
WPD 230 2X50/2X50 BL	5	2502590000
WPD 230 2X50/2X50 GN	5	2502600000
WPD 230 2X50/2X50 BN	5	2502610000
WPD 230 2X50/2X50 BK	5	2502620000

Type	Qty.	Order No.
WPDPC X30 GY	54	2503330000
WEW 35/2 GR 7042	100	1859200000
AEB 35 SC/1 BK	50	2475310000
SK WSD-S 1,5-10,0	1	9008850000
DEK 5/5 MC NE WS	1000	1609801044
WS 8/5 MM WS	800	2007150000

WPD 330

50 mm²



56.5 / 45 / 70
150 / 50
4...50

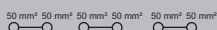

IEC 60947-7-1 Ex II 2 GD
Ex eb IIC Gb

IEC	UL	CSA	EN 60079-7
1000	1000		880
150	150		150
50	AWG 12...1/0		50

8 kV / 3
III / V-0

CE CNEX18ATEX0016U

Rated connection

6...50 / 6...50
4...35
16 / M10 (SW 5 mm)
see appendix at the end of the chapter

Type	Qty.	Order No.
WPD 330 3X50/3X50 3XGY	3	2502620000
WPD 330 3X50/3X50 1XBN/1XBK/1XGY	3	2502650000
WPD 330 1XGY/1XBL/1XGN	3	2502640000

Type	Qty.	Order No.
WPDPC X30 GY	54	2503330000
WEW 35/2 GR 7042	100	1859200000
AEB 35 SC/1 BK	50	2475310000
SK WSD-S 1,5-10,0	1	9008850000
DEK 5/5 MC NE WS	1000	1609801044
WS 8/5 MM WS	800	2007150000

WPD 330CC

50 mm²



51.2 / 45 / 70
150 / 50
4...50



IEC 60947-7-1

IEC	UL	CSA	EN 60079-7
1000			
150			
50			

8 kV / 3
III / V-0

CE

Rated connection

6...50 / 6...50
4...35
16 / M10 (SW 5 mm)
see appendix at the end of the chapter
Imax: 450 A with the connection of 6 x 50 mm²





Type	Qty.	Order No.
WPD 330CC 3X50/3X50 GY	3	2874510000
WPD 330CC 3X50/3X50 BL	3	2874520000
WPD 330CC 3X50/3X50 GN	3	2874530000
WPD 330CC 3X50/3X50 BN	3	2874540000
WPD 330CC 3X50/3X50 BK	3	2874550000





Type	Qty.	Order No.
WPDPC X30 GY	54	2503330000
WEW 35/2 GR 7042	100	1859200000
AEB 35 SC/1 BK	50	2475310000
SK WSD-S 1,5-10,0	1	9008850000
DEK 5/5 MC NE WS	1000	1609801044
WS 8/5 MM WS	800	2007150000



Power feed-in
Screw connection

Conductor connection data according to IEC 60947-7-1 (Cu), UL 1059 (Al+Cu)

Input (x1) / Output (x1)	Copper		Aluminium	
				
50 mm ²	10 Nm		14 Nm	14 Nm
35 mm ²		10 Nm		
25 mm ²	8 Nm	8 Nm	12 Nm	10 Nm
16 mm ²			10 Nm	
10 mm ²	6 Nm	6 Nm		
4 mm ²				
max. current with 2 x 50 mm ² (acc. to IEC)	300 A		270 A	
Stripping lengths	16 mm			
Allen screw	M10 (SW 5 mm)			

Input (x1) / Output (x1)	Copper		Aluminium	
				
AWG 1/0	123.9Lb In.		123.9Lb In.	123.9Lb In.
AWG 2				
AWG 4				
AWG 6				
AWG 8				
AWG 10				
AWG 12				
max. current at 1 x 50 mm ² (acc. to UL)	150 A		120 A	
Stripping lengths	16 mm			
Allen screw	M10 (SW 5 mm)			



Diagrams

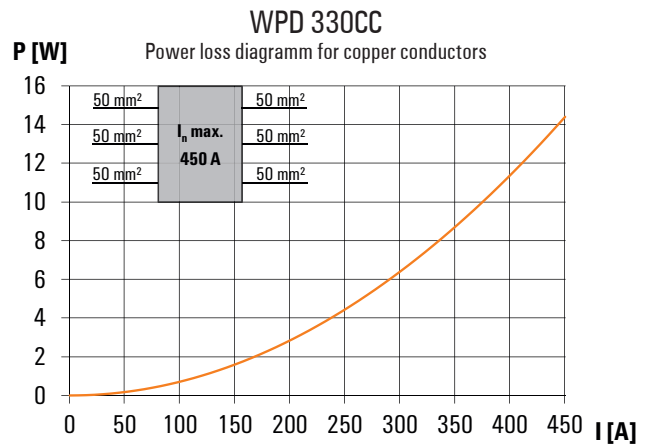
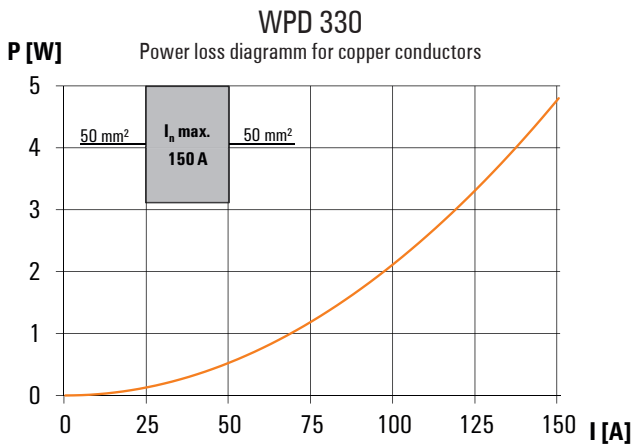
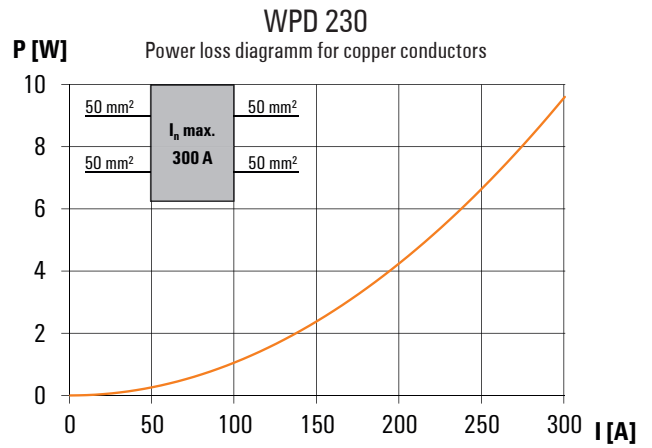
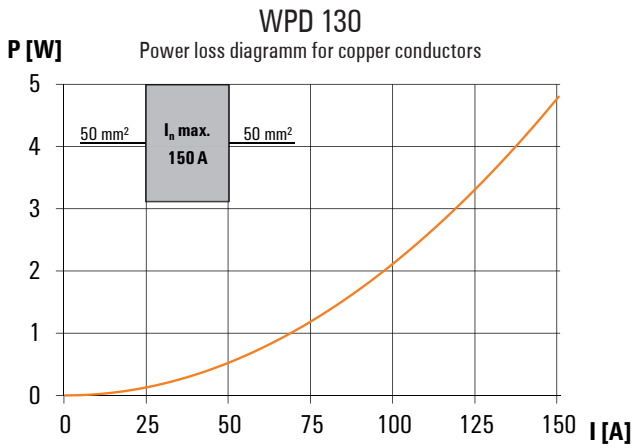



Power feed-in
Screw connection

W-Series
WPD 131 1X95/1X95



Width / Height / Depth	mm
max. current / max. conductor	A/mm ²
max. clamping range	mm ²

Technical data

Rated data	
Rated voltage	V
Rated current	A
for wire cross-section	95 mm ² mm ²
	Auxiliary connection 6 mm ² mm ²
Rated impulse withstand voltage / Pollution severity	
Overvoltage category / UL 94 flammability rating	
Approvals	
Clamped conductors (H05V/H07V)	
Solid / Stranded	95 mm ² mm ²
	Auxiliary connection 6 mm ² mm ²
Flexible with ferrule	95 mm ² mm ²
	Auxiliary connection 6 mm ² mm ²
Stripping length / Blade size	95 mm ² mm/-
	Auxiliary connection 6 mm ² mm/-
Tightening torque	Nm
Note	

Ordering data

Version	
	light grey
	blue
	green
	brown
	black
Note	

Accessories

Protective cover	
	light grey
End bracket	
	grey
	black
Screwdriver	
	SET
Identification systems	

WPD 131

95 mm²



28 / 57 / 93
232 / 95
10...95



IEC 60947-7-1

Ex II 2 GD
Ex eb IIC Gb

IEC	UL	CSA	EN 60079-7
1000	1000		880
232	200		232
95	AWG 8...3/0		95
6	AWG 16...8		6
8 kV / 3			
III / V-0			
CNEX18ATEX0016U			
Rated connection			
10...95 / 10...95			
1.5...10 / 1.5...10			
16...70			
1.5...6			
26 / M14 (SW 6)			
10 / M4 (+/- PZ2)			
see appendix at the end of the chapter			

Type	Qty.	Order No.
WPD 131 1X95/1X95 GY	2	2503090000
WPD 131 1X95/1X95 BL	2	2502660000
WPD 131 1X95/1X95 GN	2	2502670000
WPD 131 1X95/1X95 BN	2	2502680000
WPD 131 1X95/1X95 BK	2	2502690000

Type	Qty.	Order No.
WPDPC X31 GY	20	2503370000
WEW 35/2 GR 7042	100	1859200000
AEB 35 SC/1 BK	50	2475310000
SK WSD-S 1,5-10,0	1	9008850000
DEK 5/5 MC NE WS	1000	1609801044
WS 8/5 MM WS	800	2007150000

WPD 231

95 mm²



47 / 57 / 93
232 / 95
10...95

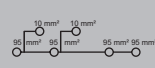

IEC 60947-7-1

Ex II 2 GD
Ex eb IIC Gb

IEC	UL	CSA	EN 60079-7
1000	1000		880
232	200		232
95	AWG 8...3/0		95
6	AWG 16...8		6
8 kV / 3			
III / V-0			
CNEX18ATEX0016U			
Rated connection			
10...95 / 10...95			
1.5...10 / 1.5...10			
16...70			
1.5...6			
26 / M14 (SW 6)			
10 / M4 (+/- PZ2)			
see appendix at the end of the chapter			
Imax: 464 A with the connection of 4 x 95 mm ²			

Type	Qty.	Order No.
WPD 231 2X95/2X95 GY	1	2502700000
WPD 231 2X95/2X95 BL	1	2502710000
WPD 231 2X95/2X95 GN	1	2502720000
WPD 231 2X95/2X95 BN	1	2502730000
WPD 231 2X95/2X95 BK	1	2502740000

Type	Qty.	Order No.
WPDPC X31 GY	20	2503370000
WEW 35/2 GR 7042	100	1859200000
AEB 35 SC/1 BK	50	2475310000
SK WSD-S 1,5-10,0	1	9008850000
DEK 5/5 MC NE WS	1000	1609801044
WS 8/5 MM WS	800	2007150000

WPD 331CC

95 mm²



66 / 57 / 93
232 / 95
10...95

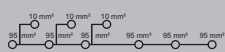

IEC 60947-7-1

IEC	UL	CSA	EN 60079-7
1000			
232			
95			
6			
8 kV / 3			
III / V-0			

CE

Rated connection

10...95 / 10...95
1.5...10 / 1.5...10
16...70
1.5...6
26 / M14 (SW 6)
10 / M4 (+/- PZ2)

see appendix at the end of the chapter

Imax: 696 A with the connection of 6 x 95 mm²







Type	Qty.	Order No.
WPD 331CC 3X95/3X95 GY	1	2874560000
WPD 331CC 3X95/3X95 BL	1	2874580000
WPD 331CC 3X95/3X95 GN	1	2874600000
WPD 331CC 3X95/3X95 BN	1	2874590000
WPD 331CC 3X95/3X95 BK	1	2874570000





Type	Qty.	Order No.
WPDPC X31 GY	20	2503370000
WEW 35/2 GR 7042	100	1859200000
AEB 35 SC/1 BK	50	2475310000
SK WSD-S 1,5-10,0	1	9008850000
DEK 5/5 MC NE WS	1000	1609801044
WS 8/5 MM WS	800	2007150000





Power feed-in
Screw connection



Conductor connection data according to IEC 60947-7-1 (Cu), UL 1059 (Al+Cu)

Input (x1) / Output (x1)	Copper		Aluminium	
				
95 mm ²	19 Nm	19 Nm	22,6 Nm	22,6 Nm
70 mm ²				
50 mm ²				
35 mm ²				
25 mm ²	14 Nm	14 Nm		
16 mm ²				
10 mm ²				
max. current with 2 x 95 mm ² (acc. to IEC)	464 A		200 A	
Stripping lengths	26 mm			
Allen screw	M14 (SW 6 mm)			

Input (x1) / Output (x1)	Copper		Aluminium	
				
AWG 3/0	200Lb In.	200Lb In.	200Lb In.	123.9Lb In.
AWG 2/0				
AWG 1/0				
AWG 2				
AWG 4				
AWG 6				
AWG 8				
max. current at 1 x 95 mm ² (acc. to UL)	200 A		155 A	
Stripping lengths	26 mm			
Allen screw	M14 (SW 6 mm)			

Auxiliary connection

	Copper	
		
10 mm ²	1,2 Nm	1,2 Nm
6 mm ²		
4 mm ²		
2.5 mm ²		
1.5 mm ²		
max. current	57 A	
Stripping lengths	10 mm	
screw	M4 (+/-PZ2)	

	Copper	
		
AWG 8	20.3Lb In.	20.3Lb In.
AWG 10		
AWG 12		
AWG 14		
AWG 16		
max. current	57 A	
Stripping lengths	10 mm	
screw	M4 (+/- PZ2)	



B

Diagrams

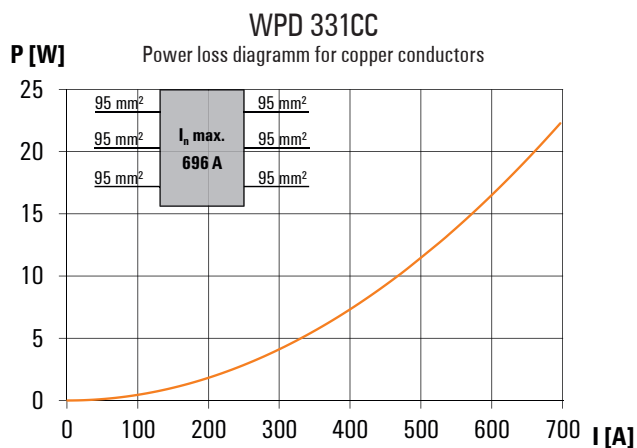
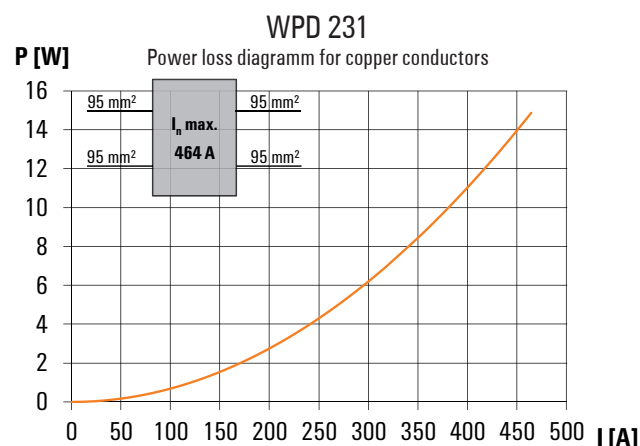
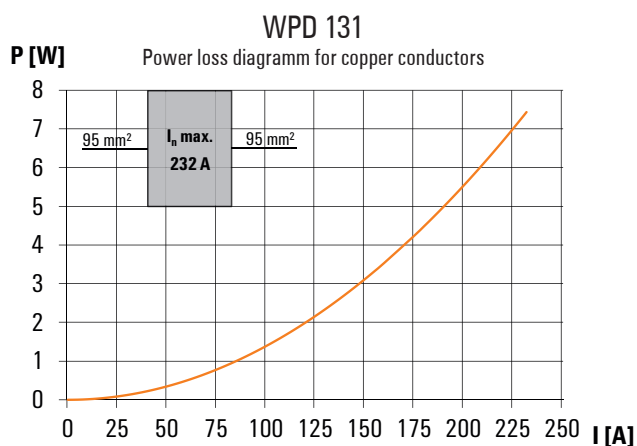



**Power feed-in
Screw connection**

**W-Series
WPD 132 1X185/1X185**



Width / Height / Depth	mm
max. current / max. conductor	A/mm ²
max. clamping range	mm ²

Technical data

Rated data	
Rated voltage	V
Rated current	A
for wire cross-section	185 mm ² mm ²
	Auxiliary connection 6 mm ² mm ²
Rated impulse withstand voltage / Pollution severity	
Overvoltage category / UL 94 flammability rating	
Approvals	
Clamped conductors (H05V/H07V)	
Solid / Stranded	185 mm ² mm ²
	Auxiliary connection 6 mm ² mm ²
Flexible with ferrule	185 mm ² mm ²
	Auxiliary connection 6 mm ² mm ²
Stripping length / Blade size	185 mm ² mm/-
	Auxiliary connection 6 mm ² mm/-
Tightening torque	Nm
Note	

Ordering data

Version	
	light grey
	blue
	green
	brown
	black
Note	

Accessories

Protective cover	
	light grey
End bracket	
	grey
	black
Screwdriver	
	SET
Identification systems	

WPD 132

185 mm²



37,5 / 73,5 / 105	
353 / 185	
25...185	



IEC 60947-7-1

Ex II 2 GD
Ex eb IIC Gb

IEC	UL	CSA	EN 60079-7
1000	1000		1100
353	310		353
185	AWG 4...kcmil 350		185
6	AWG 16...8		6
8 kV / 3			
III / V-0			
CNEX18ATEX0016U			
Rated connection			
95...185 / 95...185			
1.5...10 / 1.5...10			
25...150			
1.5...6			
29 / M18 (SW 10)			
10 / M4 (+/- PZ2)			
see appendix at the end of the chapter			
Note			

WPD 232

185 mm²



67,6 / 73,5 / 105	
353 / 185	
25...185	

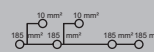

IEC 60947-7-1

Ex II 2 GD
Ex eb IIC Gb

IEC	UL	CSA	EN 60079-7
1000	1000		1100
353	310		353
185	AWG 4...kcmil 350		185
6	AWG 16...8		6
8 kV / 3			
III / V-0			
CNEX18ATEX0016U			
Rated connection			
95...185 / 95...185			
1.5...10 / 1.5...10			
25...150			
1.5...6			
29 / M18 (SW 10)			
10 / M4 (+/- PZ2)			
see appendix at the end of the chapter			
Imax: 706 A with the connection of 4 x 185 mm ²			
Note			

Type	Qty.	Order No.
WPD 232 2X185/2X185 GY	1	2502800000
WPD 232 2X185/2X185 BL	1	2502810000
WPD 232 2X185/2X185 GN	1	2502820000
WPD 232 2X185/2X185 BN	1	2502830000
WPD 232 2X185/2X185 BK	1	2502840000
Note		

Type	Qty.	Order No.
WPDPC X32 GY	12	2503380000
WEW 35/2 GR 7042	100	1859200000
AEB 35 SC/1 BK	50	2475310000
SK WSD-S 1,5-10,0	1	9008850000
DEK 5/5 MC NE WS	1000	1609801044
WS 8/5 MM WS	800	2007150000
Note		

Conductor connection data according to IEC 60947-7-1 (Cu), UL 1059 (Al+Cu)

Input (x1) / Output (x1)	Copper		Aluminium	
185 mm ²	25 Nm	25 Nm	30,9 Nm	30,9 Nm
150 mm ²				
120 mm ²				
95 mm ²				
70 mm ²				
50 mm ²	20 Nm	20 Nm	20 Nm	20 Nm
35 mm ²				
25 mm ²				
Flat band 10x15,5x0,8 mm			30,9 Nm	
max. current with 2 x 185 mm ² (acc. to IEC)	706 A		284 A	
Stripping lengths	29 mm			
Allen screw	M18 (SW 10 mm)			

Input (x1) / Output (x1)	Copper		Aluminium	
350 kcmil	250Lb In.	250Lb In.	398Lb In.	398Lb In.
300 kcmil				
250 kcmil				
AWG 3/0				
AWG 2/0				
AWG 1/0	200Lb In.	200Lb In.	200Lb In.	200Lb In.
AWG 2				
AWG 4				
max. current with 1 x 185 mm ² (acc. to UL)	310 A		250 A	
Stripping lengths	29 mm			
Allen screw	M18 (SW 10 mm)			

Auxiliary connection

	Copper	
10 mm ²	1,2 Nm	1,2 Nm
6 mm ²		
4 mm ²		
2.5 mm ²		
1.5 mm ²		
max. current	57 A	
Stripping lengths	10 mm	
screw	M4 (+/-PZ2)	

	Copper	
AWG 8	20.3Lb In.	20.3Lb In.
AWG 10		
AWG 12		
AWG 14		
AWG 16		
max. current	57 A	
Stripping lengths	10 mm	
screw	M4 (+/- PZ2)	

- Stranded
- Solid
- Flexible with ferrule
- Sector shaped
- Flat band

Diagrams

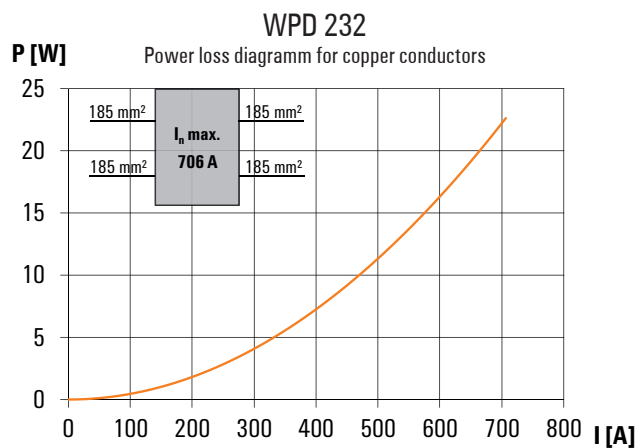
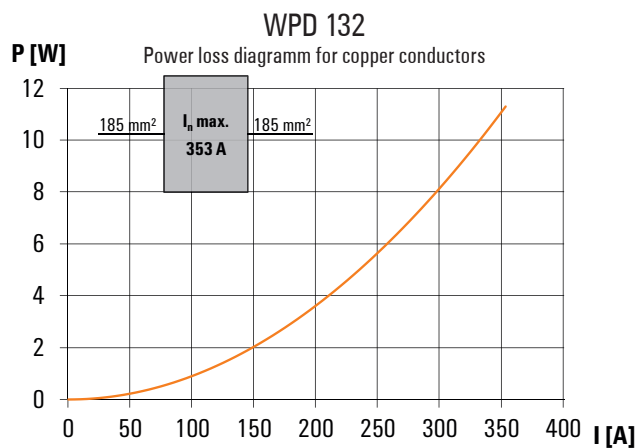

Power feed-in
Screw connection

W-Series
WPD 133 1X300/1X300



Width / Height / Depth	mm
max. current / max. conductor	A/mm ²
max. clamping range	mm ²

Technical data

Rated data	
Rated voltage	V
Rated current	A
for wire cross-section	300 mm ² mm ²
	Auxiliary connection 6 mm ² mm ²
Rated impulse withstand voltage / Pollution severity	
Overvoltage category / UL 94 flammability rating	
Approvals	
Clamped conductors (H05V/H07V)	
Solid / Stranded	300 mm ² mm ²
	Auxiliary connection 6 mm ² mm ²
Flexible with ferrule	300 mm ² mm ²
	Auxiliary connection 6 mm ² mm ²
Stripping length / Blade size	300 mm ² mm/-
	Auxiliary connection 6 mm ² mm/-
Tightening torque	Nm
Note	

Ordering data

Version	
	light grey
	blue
	green
	brown
	black
Note	

Accessories

Protective cover	
	light grey
End bracket	
	grey
	black
Screwdriver	
	SET
Identification systems	

WPD 133

300 mm²



45 / 83.5 / 118	
520 / 300	
35...300	

IEC 60947-7-1

Ex II 2 GD
Ex eb IIC Gb

IEC	UL	CSA	EN 60079-7
1000	1000		1100
520	420		340
300	AWG 2...kcmil 600		300
6	AWG 16...8		6
8 kV / 3			
III / V-0			
CNEX18ATEX0016U			
Rated connection			
150...300 / 150...300			
1.5...10 / 1.5...10			
35...240			
1.5...6			
34 / M24 (SW 12)			
10 / M4 (+/- PZ2)			
see appendix at the end of the chapter			

WPD 233

300 mm²



82.6 / 83.5 / 118	
520 / 300	
35...300	

IEC 60947-7-1









Ex II 2 GD
Ex eb IIC Gb









IEC	UL	CSA	EN 60079-7
1000	1000		1100
520	420		340
300	AWG 2...kcmil 600		300
6	AWG 16...8		6
8 kV / 3			
III / V-0			
CNEX18ATEX0016U			
Rated connection			
150...300 / 150...300			
1.5...10 / 1.5...10			
35...240			
1.5...6			
34 / M24 (SW 12)			
10 / M4 (+/- PZ2)			
see appendix at the end of the chapter			
Imax: 1040 A with the connection of 4 x 300 mm ²			

Type	Qty.	Order No.
WPD 233 2X300/2X300 GY	1	2502900000
WPD 233 2X300/2X300 BL	1	2502910000
WPD 233 2X300/2X300 GN	1	2502920000
WPD 233 2X300/2X300 BN	1	2502930000
WPD 233 2X300/2X300 BK	1	2502940000



Type	Qty.	Order No.
WPDPC X33 GY	8	2503390000
WEW 35/2 GR 7042	100	1859200000
AEB 35 SC/1 BK	50	2475310000
SK WSD-S 1,5-10,0	1	9008850000
DEK 5/5 MC NE WS	1000	1609801044
WS 8/5 MM WS	800	2007150000



Conductor connection data according to IEC 60947-7-1 (Cu), UL 1059 (Al+Cu)





Input (x1) / Output (x1)	Copper			Aluminium	
					
300 mm ²	45 Nm			65 Nm	65 Nm
240 mm ²					
185 mm ²					
150 mm ²					
120 mm ²	30 Nm			65 Nm	
95 mm ²					
70 mm ²					
50 mm ²					
35 mm ²					
Flat band 10x20x1 mm				65 Nm	
Max. current with 2 x 300 mm ² (acc. to IEC)	1040 A			340 A	
Stripping lengths	34 mm				
Allen screw	M24 (SW 12 mm)				

Input (x1) / Output (x1)	Copper		Aluminium	
				
600 kcmil	300Lb In.			575Lb In.
500 kcmil				
350 kcmil				
300 kcmil				
250 kcmil	200Lb In.			575Lb In.
AWG 3/0				
AWG 2/0				
AWG 1				
AWG 2				
Max. current at 1 x 300 mm ² (acc. to UL)	420 A		340 A	
Stripping lengths	34 mm			
Allen screw	M24 (SW 12 mm)			

Auxiliary connection

	Copper	
		
10 mm ²	1,2 Nm	1,2 Nm
6 mm ²		
4 mm ²		
2.5 mm ²		
1.5 mm ²		
max. current	57 A	
Stripping lengths	10 mm	
screw	M4 (+/-PZ2)	

	Copper	
		
AWG 8	20.3Lb In.	20.3Lb In.
AWG 10		
AWG 12		
AWG 14		
AWG 16		
max. current	57 A	
Stripping lengths	10 mm	
screw	M4 (+/- PZ2)	

-  Stranded
-  Solid
-  Flexible with ferrule
-  Sector shaped
-  Flat band

Drawings

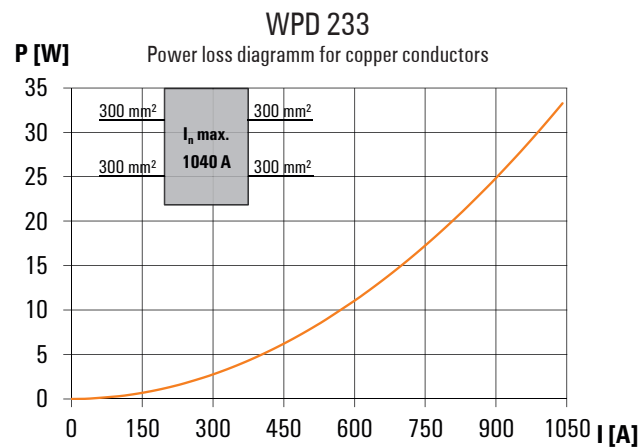
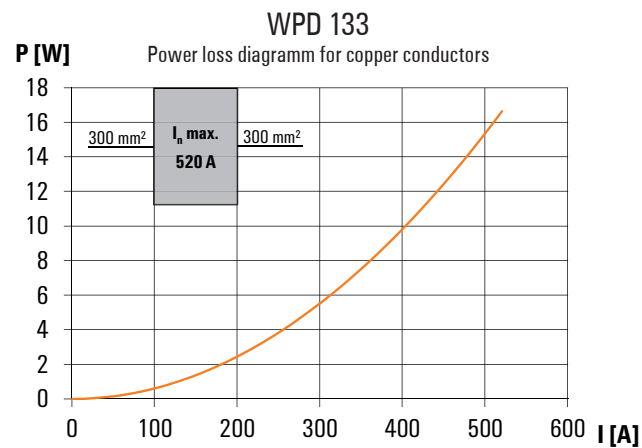

Application range

B 

The secure and efficient way of distributing power

Klippon® Connect provides the required flexibility

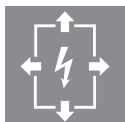

Safe power supply to equipment such as motors is decisive for the availability of plants and machines. The use of increasingly large wire cross-sections and restricted space in the panel is increasing the demands on terminal blocks and distribution blocks and posing new challenges for panel planners. Our comprehensive product range for power distribution ensures excellent flexibility, even in the planning stages. The variety of possible combinations gives you just what you need for all power distribution requirements and enables compact panel design.

Our promise

Rapid installation and flexible combination options with Klippon® Connect, for simple, space-saving installation and increased productivity in the construction of switchgear and panel. This makes the design of your power distribution system noticeably more efficient.

B



Space saving

- Space-saving format and variety of functions in a single design
- Flexible expansion thanks to series arrangement and cross connection

Time saving

- Compatible with TS 35 terminal rail
- Optimised design for simple handling and fast installation, even under challenging conditions

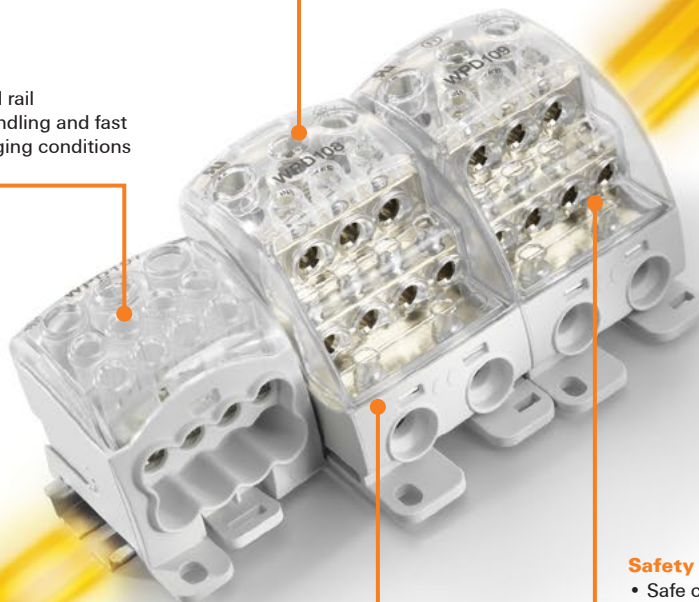

Safety

- Safe conductor connection supported by step design
- Finger safety guaranteed in accordance with EN 50274
- Short-circuit resistance to highest SCCR standard

Flexibility

- Range of possible combinations for each requirement
- Can be used around the world thanks to international approvals



Our range



More space, more options – even for aluminium wires:

The slim design of our WPD X01–X03 main line branch terminals saves a great deal of space. With certification for aluminium conductors according to IEC 61238 “Class A” and a permissible voltage of 1,000 V DC, they meet all the requirements of complex applications.



All-rounder for a better overview:

Our WPD X00 & X04-X09 distribution blocks are used in all situations where power is supplied and distributed. Their user-friendly design creates a better overview and enables rapid, efficient implementation of space-saving power distribution.

Power distribution
Hybrid connection

AWPD 35 4X6/6X2.5

35 mm²

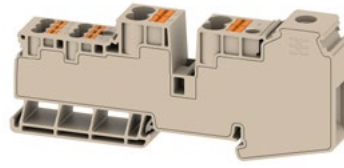

AWPD 35 4X10

35 mm²

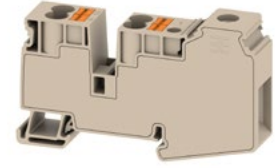

Width / Height / Depth	mm
max. current / max. conductor	A / mm ²
max. clamping range	mm ²

16.2 x 125 x 50

Screw 35 mm ²	PUSH IN 35 mm ²	PUSH IN 6 mm ²
105 / 35	24 / 2.5	41 / 6
1.5...35	0.14...2.5	0.5...6

16.2 x 95 x 60

Screw 35 mm ²	PUSH IN 10 mm ²
105 / 35	50 / 10
1.5...35	1...10

Technical data

Rated voltage	Screw 35 mm ²	V
	PUSH IN 2.5 mm ²	V
	PUSH IN 6 mm ²	V
	PUSH IN 10 mm ²	V
Rated current	Screw 35 mm ²	A
	PUSH IN 2.5 mm ²	A
	PUSH IN 6 mm ²	A
	PUSH IN 10 mm ²	A
for wire cross-section	Screw 35 mm ²	mm ²
	PUSH IN 2.5 mm ²	mm ²
	PUSH IN 6 mm ²	mm ²
	PUSH IN 10 mm ²	mm ²

IEC 60947-1

IEC	UL	CSA
1000	600	
1000	600	
1000	600	
110	105	
24	40	
41	20	
35	AWG 14...2	
2.5	AWG 20...8	
6	AWG 22...12	

IEC 60947-1

IEC	UL	CSA
1000	600	
1000	600	
1000	600	
110	105	
57	50	
35	AWG 14...2	
10	AWG 20...6	

Rated impulse withstand voltage / Pollution severity	
Gauge to IEC 60947-1	
UL 94 flammability rating	
Approvals	
Clamped conductors (H05V/H07V)	
Solid / Stranded	mm ²
flexible / flexible with ferrule	mm ²
Stripping length / Blade size	mm / mm
Tightening torque	Nm

Screw 35 mm ²	PUSH IN 2.5 mm ²	PUSH IN 6 mm ²
8kV / 3	8kV / 3	8kV / 3
B9	A3	A5
V-0	V-0	V-0
CE cRU_{us}		
Screw 35 mm ²	PUSH IN 2.5 mm ²	PUSH IN 6 mm ²
1.5...35 / 1.5...35	0.5...4 / 0.14...2.5	0.5...10 / 0.5...6
1.5...35 / 1.5...35	0.5...2.5 / 0.5...2.5	0.5...6 / 0.5...6
17 / 1 x 5.5	10 / 0.6 x 3.5	12 / 1 x 5.5
2.5		

Screw 35 mm ²	PUSH IN 10 mm ²
8kV / 3	8kV / 3
B9	A6
V-0	V-0
CE cRU_{us}	
Screw 35 mm ²	PUSH IN 10 mm ²
1.5...35 / 1.5...35	1...10 / 1...10
1.5...35 / 1.5...35	1...10 / 1...10
17 / 1 x 5.5	18 / 1 x 5.5
2.5	

Ordering data

Version	dark beige
	blue

Type	Qty.	Order No.
AWPD 35 4X6/6X2.5	20	2728620000
AWPD 35 4X6/6X2.5 BL	20	2860560000

Type	Qty.	Order No.
AWPD 35 4X10	20	2728630000
AWPD 35 4X10 BL	20	2860570000

Accessories

Pluggable cross-connection	
for 1.5 mm ²	2-pole
	10-pole
for 2.5 mm ²	2-pole
	10-pole
for 6 mm ²	2-pole
	10-pole
for 6 mm ²	2-pole
	10-pole
End bracket	
	dark beige
Test adapter	
	1-pole
	1-pole
Screwdriver	
for 2.5 mm ² PUSH IN	Standard
for 6 mm ² PUSH IN	Standard
for 10 mm ² PUSH IN	Standard
for 35 mm ² Schraube	Standard
Identification systems	

Type	Rated current	Qty.	Order No.
ZQV 1.5N/2	17.5 A	60	1985410000
ZQV 1.5N/10	17.5 A	20	1985580000
ZQV 2.5N/2	24 A	60	1527540000
ZQV 2.5N/10	24 A	20	1527690000
ZQV 4N/2	32 A	60	1527930000
ZQV 4N/10	32 A	20	1528090000
ZQV 6N/2	41 A	60	1985740000
ZQV 6N/10	41 A	20	1985780000
AEB 35 SCL/1 VO		50	2661280000
ATPG 1.5-10 L		50	1991890000
PS 2.0 MC		20	0310000000
SDIS 0.6X3.5X100		1	2749810000
SDIS 1.0X5.5X125		1	2749850000
SDIS 1.0X5.5X125		1	2749850000
SDIS 1.0X5.5X125		1	2749850000
DEK 5/5 PLUS MC NE WS	1000		1854490000
DEK 5/5 MM WS	800		2007110000
DEK 8/5 MM WS	800		2007150000
WS-A 8/16 MM WS	200		2619910000

Type	Rated current	Qty.	Order No.
ZQV 1.5N/2	17.5 A	60	1985410000
ZQV 1.5N/10	17.5 A	20	1985580000
ZQV 2.5N/2	24 A	60	1527540000
ZQV 2.5N/10	24 A	20	1527690000
ZQV 4N/2	32 A	60	1527930000
ZQV 4N/10	32 A	20	1528090000
ZQV 6N/2	41 A	60	1985740000
ZQV 6N/10	41 A	20	1985780000
AEB 35 SCL/1 VO		50	2661280000
ATPG 1.5-10 L		50	1991890000
PS 2.0 MC		20	0310000000
SDIS 0.6X3.5X100		1	2749810000
SDIS 1.0X5.5X125		1	2749850000
SDIS 1.0X5.5X125		1	2749850000
SDIS 1.0X5.5X125		1	2749850000
DEK 5/5 PLUS MC NE WS	1000		1854490000
DEK 5/5 MM WS	800		2007110000
DEK 8/5 MM WS	800		2007150000
WS-A 8/16 MM WS	200		2619910000

For detailed information on other accessories and application in the online catalogue

AWPD potential distribution terminal block

The potential distribution terminal block AWPD 35 can be fed by wires of crosssection 1.5 - 35 mm². Over standard cross-connections the potential is distributed over any number of terminals blocks of smaller crosssection. Some variants for potential distribution during feed-in are indicated in the table below, including the cross-connection which can be used and the maximum current allowed.



Integrated into separation plate



Maximum current flow I_{max} only with AWPD 35 4X10

Output terminal	Cross-connection	Wire cross-section Feed-in	Feed-in left or right
AWPD 35 4X10	ZQV 6N	35 mm ²	82 A

Maximum current flow I_{max} only with AWPD 35 4X6/6X2.5

Output terminal	Cross-connection	Wire cross-section Feed-in	Feed-in left or right
AWPD 35 4X6/6X2.5	ZQV 6N	35 mm ²	82 A

Maximum current flow I_{max} only with AWPD 35 4X10

Output terminal	Cross-connection	Wire cross-section Feed-in	Feed-in left or right	Feed-in centred
AWPD 35 4X10	ZQV 6N	35 mm ²	41 A	82 A

Maximum current flow I_{max} only with AWPD 35 4X6/6X2.5

Output terminal	Cross-connection	Wire cross-section Feed-in	Feed-in left or right	Feed-in centred
AWPD 35 4X6/6X2.5	ZQV 6N	35 mm ²	41 A	82 A

Maximum current flow I_{max} only with AWPD 35 4X6/6X2.5



Output terminal	Cross-connection	Wire cross-section Feed-in	Feed-in left or right	Feed-in centred
A2C 1.5	ZQV 1.5N	35 mm ²	48 A	72 A
A3C 1.5	ZQV 1.5N	35 mm ²	48 A	72 A
A4C 1.5	ZQV 1.5N	35 mm ²	48 A	72 A
A2C 2.5	ZQV 2.5N	35 mm ²	68 A	76 A
A3C 2.5	ZQV 2.5N	35 mm ²	68 A	76 A
A4C 2.5	ZQV 2.5N	35 mm ²	68 A	76 A
A2C 4	ZQV 4N	35 mm ²	76 A	76 A
A3C 4	ZQV 4N	35 mm ²	76 A	76 A
A4C 4	ZQV 4N	35 mm ²	76 A	76 A
A2C 6	ZQV 6N	35 mm ²	76 A	82 A
A3C 6	ZQV 6N	35 mm ²	76 A	82 A

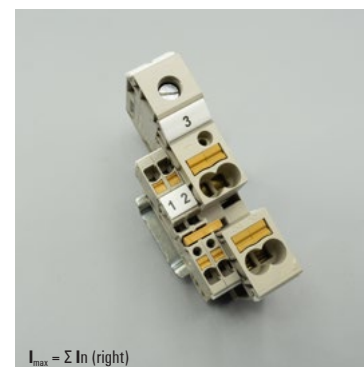
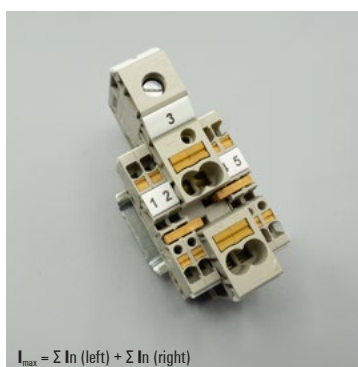
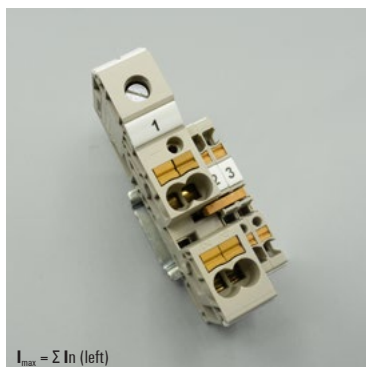

Maximum current flow I_{max} only with AWPD 35 4X10

Output terminal	Cross-connection	Wire cross-section Feed-in	Feed-in left or right	Feed-in centred
A2C 1.5	ZQV 1.5N	35 mm ²	48 A	72 A
A3C 1.5	ZQV 1.5N	35 mm ²	48 A	72 A
A4C 1.5	ZQV 1.5N	35 mm ²	48 A	72 A
A2C 2.5	ZQV 2.5N	35 mm ²	68 A	76 A
A3C 2.5	ZQV 2.5N	35 mm ²	68 A	76 A
A4C 2.5	ZQV 2.5N	35 mm ²	68 A	76 A
A2C 4	ZQV 4N	35 mm ²	76 A	76 A
A3C 4	ZQV 4N	35 mm ²	76 A	76 A
A4C 4	ZQV 4N	35 mm ²	76 A	76 A
A2C 6	ZQV 6N	35 mm ²	76 A	82 A
A3C 6	ZQV 6N	35 mm ²	76 A	82 A



Conductor connection data according to DIN EN 60998-1 (Cu), IEC 61238-1 class A (Cu+Al)

Input (x2)	Copper		Aluminium
2x25 mm ²			
25 mm ²	3 Nm	3 Nm	4 Nm
16 mm ²			
10 mm ²			
6 mm ²			
4 mm ²			
2.5 mm ²			
1.5 mm ²			
Stripping lengths	17 mm		
screw	M6 (+/- PZ2)		

Output (x6)	Copper		Aluminium
6x10 mm ²			
10 mm ²	2 Nm	2 Nm	3 Nm
6 mm ²			
4 mm ²			
2.5 mm ²			
1.5 mm ²			
Stripping lengths	9 mm		
screw	M5 (+/- PZ2)		

 Stranded
  Solid
  Flexible with ferrule



Power distribution
Screw connection

W-Series
WPD 110 1X70+1X35/6X16



Width / Height / Depth	mm
max. current / max. conductor	A/mm ²
max. clamping range	mm ²

Technical data

Rated data	
Rated voltage	V
Rated current	A
for wire cross-section	70 mm ² mm ²
Rated impulse withstand voltage / Pollution severity	
Overvoltage category / UL 94 flammability rating	
Approvals	
Clamped conductors (H05V/H07V)	
Solid / Stranded	70 mm ² mm ²
	35 mm ² mm ²
	16 mm ² mm ²
Flexible with ferrule	70 mm ² mm ²
	35 mm ² mm ²
	16 mm ² mm ²
Stripping length / Blade size	70 mm ² mm/-
	35 mm ² mm/-
	16 mm ² mm/-
Tightening torque	Nm
Note	

Ordering data

Version	
	light grey
	blue
	green
	brown
	black
Note	

Accessories

End bracket	
	dark beige
	dark beige
Screwdriver	

WPD 110

70 mm²



38.5 / 63 / 69.5	
192 / 70	
1.5...70	

IEC 60947-7-1

IEC	UL	CSA	EN 60079-7
1000			
200			
70			
		8 kV / 3	
		III / V-0	
Rated connection			
10...70 / 4...35			
4...35 / 4...35			
1.5...16 / 1.5...16			
6...50			
2.5...25			
1.5...10			
27 / M10			
26 / M8			
13 / M6			
see appendix at the end of the chapter			
Note			









Type	Qty.	Order No.
WPD 110 1X70+1X35/6X16 GY	3	2603810000
WPD 110 1X70+1X35/6X16 BL	3	2603820000
WPD 110 1X70+1X35/6X16 GN	3	2603830000
WPD 110 1X70+1X35/6X16 BN	3	2814520000
WPD 110 1X70+1X35/6X16 BK	3	2814510000



Type	Qty.	Order No.
WEW 35/2	100	1061200000
AEB 35 SC/1	50	1991920000
SDK PZ2 X 100	1	2749450000





Conductor connection data according to DIN EN 60998-1 (Cu), IEC 61238-1 class A (Cu+Al)

Input	Copper		Aluminium
1x 70 mm ²			
70 mm ²	10 Nm	10 Nm	12 Nm
50 mm ²			
35 mm ²			
25 mm ²			
16 mm ²			
10 mm ²			
6 mm ²			
Stripping lengths	27 mm		
Screw	M10 (+/- PZ2)		

Input	Copper		Aluminium
1x 35 mm ²			
35 mm ²	6 Nm	6 Nm	
25 mm ²			
16 mm ²			
10 mm ²			
6 mm ²			
4 mm ²			
2,5 mm ²			
Stripping lengths	26 mm		
Screw	M8 (+/- PZ2)		

Output	Copper		Aluminium
6x 16 mm ²			
16 mm ²	3 Nm	3 Nm	10 Nm
10 mm ²			
6 mm ²			
4 mm ²			
2.5 mm ²			
1.5 mm ²			
Stripping lengths	13 mm		
Screw	M6 (+/- PZ2)		

 Stranded
  Solid
  Flexible with ferrule



Power distribution
Screw connection

W-Series
WPD 101 2X25/2X16



Width / Height / Depth	mm
max. current / max. conductor	A/mm ²
max. clamping range	mm ²

Technical data

Rated data	
Rated voltage	V
Rated current	A
for wire cross-section	25 mm ² mm ²
Rated impulse withstand voltage / Pollution severity	
Overvoltage category / UL 94 flammability rating	
Approvals	
Clamped conductors (H05V/H07V)	
Solid / Stranded	25 mm ² mm ²
	16 mm ² mm ²
Flexible with ferrule	25 mm ² mm ²
	16 mm ² mm ²
Stripping length / Blade size	25 mm ² mm/-
	16 mm ² mm/-
Tightening torque	Nm
Note	

Ordering data

Version	
	light grey
	blue
	green
	brown
	black
	3x light grey / blue
	green / 3x light grey / blue
Note	

Accessories

End bracket	
	dark beige
	dark beige
Screwdriver	

WPD 101

25 mm²



17.8 / 49.3 / 55.7
101 / 25
1.5...25

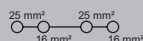

IEC 60947-7-1

IEC	UL	CSA	EN 60079-7
1000	600		
152	90		
25	AWG 16...4		
8 kV / 3			
III / V-0			
Rated connection			
2.5...25 / 2.5...25			
1.5...16 / 1.5...16			
1.5...16			
1.5...10			
19 / M6 (+/- PZ2)			
19 / M6 (+/- PZ2)			
see appendix at the end of the chapter			
Imax: 164 A with the connection of 4 x 16 mm ²			

Type	Qty.	Order No.
WPD 101 2X25/2X16 GY	5	1560730000
WPD 101 2X25/2X16 BL	5	1560670000
WPD 101 2X25/2X16 GN	5	1560650000
WPD 101 2X25/2X16 BN	5	1561120000
WPD 101 2X25/2X16 BK	5	1561100000

Type	Qty.	Order No.
WEW 35/2	100	1061200000
AEB 35 SC/1	50	1991920000
SDK PZ2 X 100	1	2749450000

WPD 301

25 mm²



53 / 49.3 / 55.7
101 / 25
1.5...25



IEC 60947-7-1

IEC	UL	CSA	EN 60079-7
1000			
152			
25			
8 kV / 3			
III / V-0			
Rated connection			
2.5...25 / 2.5...25			
1.5...16 / 1.5...16			
1.5...16			
1.5...10			
19 / M6 (+/- PZ2)			
19 / M6 (+/- PZ2)			
see appendix at the end of the chapter			
Imax: 164 A with the connection of 4 x 16 mm ²			

Type	Qty.	Order No.
WPD 301 2X25/2X16 3XGY	2	1561130000

Type	Qty.	Order No.
WEW 35/2	100	1061200000
AEB 35 SC/1	50	1991920000
SDK PZ2 X 100	1	2749450000

Power distribution
Screw connection

W-Series
WPD 201 2X25/2X16



Width / Height / Depth	mm
max. current / max. conductor	A/mm ²
max. clamping range	mm ²

Technical data

Rated data		
Rated voltage		V
Rated current		A
for wire cross-section	25 mm ²	mm ²
Rated impulse withstand voltage / Pollution severity		
Overvoltage category / UL 94 flammability rating		
Approvals		
Clamped conductors (H05V/H07V)		
Solid / Stranded	25 mm ²	mm ²
	16 mm ²	mm ²
Flexible with ferrule	25 mm ²	mm ²
	16 mm ²	mm ²
Stripping length / Blade size	25 mm ²	mm/-
	16 mm ²	mm/-
Tightening torque		Nm
Note		

Ordering data

Version	
	light grey
	blue
	green
	brown
	black
Note	

Accessories

End bracket	
	dark beige
	dark beige
Screwdriver	

WPD 201

25 mm²



34.2 / 49.3 / 52
152 / 25
1.5...25

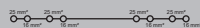

IEC 60947-7-1

IEC	UL	CSA	EN 60079-7
1000			
101			
25			
		8 kV / 3	
		III / V-0	
CE			
Rated connection			
2.5...25 / 2.5...25			
1.5...16 / 1.5...16			
1.5...16			
1.5...10			
19 / M6 (+/- PZ2)			
19 / M6 (+/- PZ2)			
see appendix at the end of the chapter			
I _{max} : 328 A with the connection of 8 x 16 mm ²			



Type	Qty.	Order No.
WPD 201 4X25/4X16 GY	1	2731220000
WPD 201 4X25/4X16 BL	1	2731230000
WPD 201 4X25/4X16 GN	1	2731240000
WPD 201 4X25/4X16 BN	1	2731250000
WPD 201 4X25/4X16 BK	1	2731260000

Type	Qty.	Order No.
WEW 35/2	100	1061200000
AEB 35 SC/1	50	1991920000
SDK PZ2 X 100	1	2749450000



Conductor connection data according to VDE 0603-2 (Cu), IEC 60947-7-1 (Cu), IEC 61238-1 Class A (Cu+Al)

Input (x2) / Output (x2)	Copper		Aluminium	Input (x2) / Output (x2)	Copper		Aluminium
2x25 mm ² (round conductor)				2x16 mm ² (round conductor)			
25 mm ²	3,5 Nm	3,5 Nm	4 Nm	25 mm ²	2,5 Nm	2,5 Nm	4 Nm
16 mm ²							
10 mm ²							
6 mm ²							
4 mm ²							
2,5 mm ²				1,5 mm ²			
Stripping lengths screw	19 mm			19 mm			
	M6 (+/- PZ2)			M6 (+/- PZ2)			



Stranded

Solid

Flexible with ferrule

Conductor connection data according to UL 1059 (Al+Cu)

Certificate no. (UR)		XCFR2.E60693				
Input (line)	Line		Load			
	Copper	Aluminium	Copper	Copper	Aluminium	Aluminium
AWG 4	22.1 Lb In	22.1 Lb In	22.1 Lb In	22.1 Lb In	22.1 Lb In	35 Lb In
AWG 6						
AWG 8						
AWG 10						
AWG 12						
AWG 14						
AWG 16						
max. current	90 A	90 A	65 A	65 A	50 A	50 A
Voltage size B,C (UR)	600 V					

CSA Rating data according to CSA 22.2 No. 158 ng data

Certificate no. (cURus)		XCFR2.E60693				
Input (line)	Line		Load			
	Copper	Aluminium	Copper	Copper	Aluminium	Aluminium
AWG 4	2.5 Nm	2.5 Nm	2.1 Nm	2.1 Nm	2.1 Nm	4 Nm
AWG 6						
AWG 8						
AWG 10						
AWG 12						
AWG 14						
AWG 16						
max. current	90 A	90 A	65 A	65 A	50 A	50 A
Voltage size B,C (UR)	600 V					

WPD x01

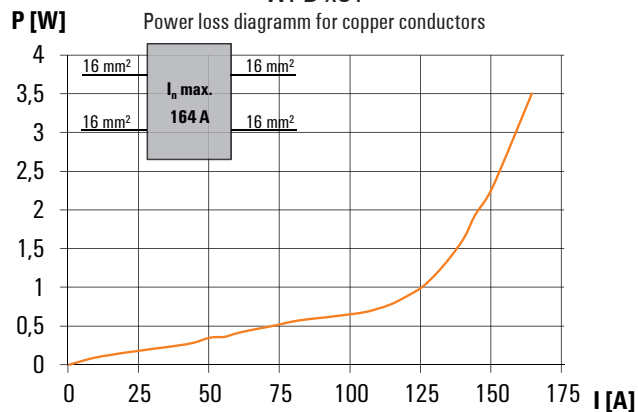

WPD 201

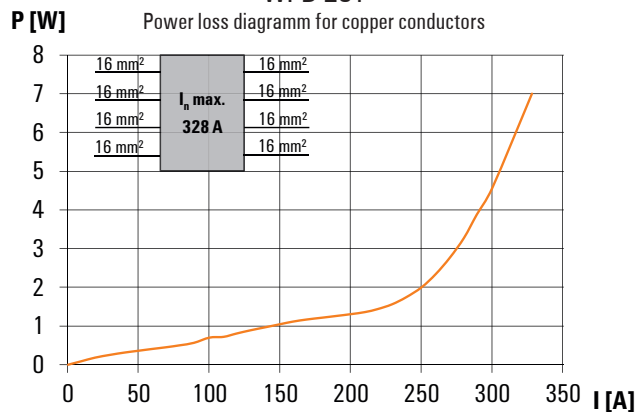

Power distribution
Screw connection

W-Series
WPD 102 2X35/2X25



Width / Height / Depth	mm
max. current / max. conductor	A/mm ²
max. clamping range	mm ²

Technical data

Rated data		
Rated voltage		V
Rated current		A
for wire cross-section	35 mm ²	mm ²
Rated impulse withstand voltage / Pollution severity		
Overvoltage category / UL 94 flammability rating		
Approvals		
Clamped conductors (H05V/H07V)		
Solid / Stranded	35 mm ²	mm ²
	25 mm ²	mm ²
Flexible with ferrule	35 mm ²	mm ²
	25 mm ²	mm ²
Stripping length / Blade size	35 mm ²	mm/-
	25 mm ²	mm/-
Tightening torque		Nm
Note		

Ordering data

Version	
	light grey
	blue
	green
	brown
	black
Note	

Accessories

End bracket	
	dark beige
	dark beige
Screwdriver	

WPD 102

35 mm²



22.2 / 49.3 / 55.7
125 / 35
2.5...35

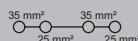

IEC 60947-7-1

IEC	UL	CSA	EN 60079-7
1000	600		
202	115		
35	AWG 16...2		
8 kV / 3			
III / V-0			
Rated connection			
4...35 / 4...35			
2.5...25 / 2.5...25			
2.5...25			
2.5...16			
22 / M6 (+/- PZ2)			
18 / M6 (+/- PZ2)			
see appendix at the end of the chapter			
Imax: 214 A with the connection of 4 x 25 mm ²			

Type	Qty.	Order No.
WPD 102 2X35/2X25 GY	5	1561680000
WPD 102 2X35/2X25 BL	5	1561640000
WPD 102 2X35/2X25 GN	5	1561670000
WPD 102 2X35/2X25 BN	5	1561650000
WPD 102 2X35/2X25 BK	5	1561630000

Type	Qty.	Order No.
WEW 35/2	100	1061200000
AEB 35 SC/1	50	1991920000
SDK PZ2	1	9008540000

WPD 302

35 mm²



66.6 / 49.3 / 55.7
125 / 35
2.5...35



IEC 60947-7-1

IEC	UL	CSA	EN 60079-7
1000			
202			
35			
8 kV / 3			
III / V-0			
Rated connection			
4...35 / 4...35			
2.5...25 / 2.5...25			
2.5...25			
2.5...16			
22 / M6 (+/- PZ2)			
18 / M6 (+/- PZ2)			
see appendix at the end of the chapter			
Imax: 214 A with the connection of 4 x 25 mm ²			

Type	Qty.	Order No.
WPD 302 2X35/2X25 3XGY	2	1561740000

Type	Qty.	Order No.
WEW 35/2	100	1061200000
AEB 35 SC/1	50	1991920000
SDK PZ2	1	9008540000

Conductor connection data according to VDE 0603-2 (Cu), IEC 60947-7-1 (Cu), IEC 61238-1 Class A (Cu+Al)

Input (x2) / Output (x2)	Copper		Aluminium
2x35 mm ² (round conductor)			
35 mm ²	3,5 Nm	3,5 Nm	8 Nm
25 mm ²			6 Nm
16 mm ²			4 Nm
10 mm ²			
6 mm ²			
4 mm ²			
2.5 mm ²			
1.5 mm ²			
Stripping lengths	22 mm		
screw	M6 (+/- PZ2)		

Input (x2) / Output (x2)	Copper		Aluminium
2x35 mm ² (round conductor)			
35 mm ²	3,5 Nm	3,5 Nm	
25 mm ²			6 Nm
16 mm ²			4 Nm
10 mm ²			
6 mm ²			
4 mm ²			
2.5 mm ²			
1.5 mm ²			
Stripping lengths	18 mm		
screw	M6 (+/- PZ2)		



Stranded

Solid

Flexible with ferrule

Conductor connection data according to UL 1059 (Al+Cu)

Certificate no. (UR)	XCFR2.E60693					
Input (line)	Line			Load		
	Copper	Aluminium	Copper	Copper	Aluminium	
AWG 4	31 Lb In		70,8 Lb In			
AWG 6			53 Lb In		53 Lb In	
AWG 8		31 Lb In		53 Lb In	22.1 Lb In	35 Lb In
AWG 10						
AWG 12						
AWG 14						
AWG 16						
max. current	125 A	115 A	90 A	85 A	65 A	
Voltage size B,C (UR)	600 V					

CSA Rating data according to CSA 22.2 No. 158

Certificate no. (cURus)	XCFR2.E60693					
Input (line)	Line			Load		
	Copper	Aluminium	Copper	Copper	Aluminium	
AWG 4	3,5 Nm		8 Nm			
AWG 6			6 Nm		6 Nm	
AWG 8		3,5 Nm		4 Nm	3,5 Nm	4 Nm
AWG 10						
AWG 12						
AWG 14						
AWG 16						
max. current	125 A	85 A	90 A	85 A	65 A	
Voltage size B,C (UR)	600 V					

WPD 102 / WPD 302

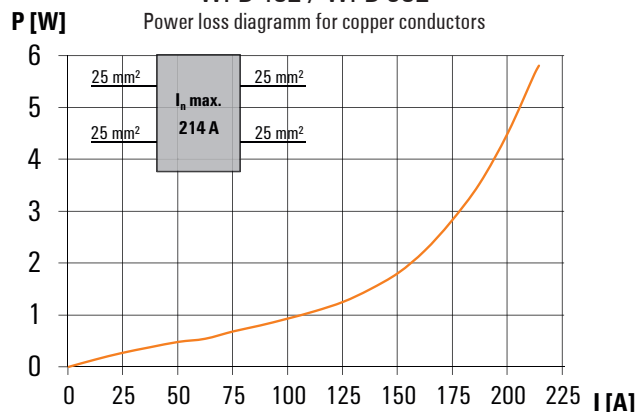

Power distribution
Screw connection

W-Series

WPD 202 4X35/4X25



Application range

WPD 202

35 mm²



Width / Height / Depth	mm
max. current / max. conductor	A/mm ²
max. clamping range	mm ²

43.2 / 49.3 / 55.7
125 / 35
2.5...35

Technical data

Rated data		
Rated voltage		V
Rated current		A
for wire cross-section	35 mm ²	mm ²
Rated impulse withstand voltage / Pollution severity		
Overvoltage category / UL 94 flammability rating		
Approvals		
Clamped conductors (H05V/H07V)		
Solid / Stranded	35 mm ²	mm ²
	25 mm ²	mm ²
Flexible with ferrule	35 mm ²	mm ²
	25 mm ²	mm ²
Stripping length / Blade size	35 mm ²	mm/-
	25 mm ²	mm/-
Tightening torque		Nm
Note		

IEC 60947-7-1

IEC	UL	CSA	EN 60079-7
1000			
202			
35			
8 kV / 3			
III / V-0			
CE			
Rated connection			
4...35 / 4...35			
2.5...25 / 2.5...25			
2.5...25			
2.5...16			
22 / M6 (+/- PZ2)			
18 / M6 (+/- PZ2)			
see appendix at the end of the chapter			
I _{max} : 428 A with the connection of 8 x 25 mm ²			



Ordering data

Version	
	light grey
	blue
	green
	brown
	black
Note	

Type	Qty.	Order No.
WPD 202 4X35/4X25 GY	2	1561730000
WPD 202 4X35/4X25 BL	2	1561700000
WPD 202 4X35/4X25 GN	2	1561620000
WPD 202 4X35/4X25 BN	2	1561720000
WPD 202 4X35/4X25 BK	2	1561690000

Accessories

End bracket	
	dark beige
	dark beige
Screwdriver	

Type	Qty.	Order No.
WEW 35/2	100	1061200000
AEB 35 SC/1	50	1991920000
SDK PZ2 X 100	1	2749450000

B



Conductor connection data according to VDE 0603-2 (Cu), IEC 60947-1 (Cu), IEC 61238-1 Class A (Cu+Al)

Input (x4) / Output (x4)	Copper		Aluminium
4x35 mm ² (round conductor)			
35 mm ²	3,5 Nm	3,5 Nm	8 Nm
25 mm ²			6 Nm
16 mm ²			4 Nm
10 mm ²			
6 mm ²			
4 mm ²			
2.5 mm ²			
1.5 mm ²			
Stripping lengths	22 mm		
screw	M8 (+/- PZ2)		

Input (x4) / Output (x4)	Copper		Aluminium
4x25 mm ² (round conductor)			
35 mm ²	3,5 Nm	3,5 Nm	6 Nm
25 mm ²			4 Nm
16 mm ²			
10 mm ²			
6 mm ²			
4 mm ²			
2.5 mm ²			
1.5 mm ²			
Stripping lengths	18 mm		
screw	M6 (+/- PZ2)		



Conductor connection data according to UL 1059 (Al+Cu)

Input (line)	Line		Load			
	Copper	Aluminium	Copper		Aluminium	
AWG 4	31 Lb In	31 Lb In	70.8 Lb In	22.1 Lb In	22.1 Lb In	
AWG 6			53 Lb In			53 Lb In
AWG 8			53 Lb In			35 Lb In
AWG 10						
AWG 12						
AWG 14						
AWG 16						
max. current	125 A	115 A	90 A	85 A	65 A	65 A
Voltage size B,C (UR)	600 V					

CSA Rating data according to CSA 22.2 No. 158

Input (line)	Line		Load			
	Copper	Aluminium	Copper		Aluminium	
AWG 4	3.5 Nm	3.5 Nm	8 Nm	3.5 Nm	3.5 Nm	
AWG 6			6 Nm			6 Nm
AWG 8			4 Nm			4 Nm
AWG 10						
AWG 12						
AWG 14						
AWG 16						
max. current	125 A	85 A	90 A	85 A	65 A	65 A
Voltage size B,C (UR)	600 V					

WPD 202

Power loss diagram for copper conductors

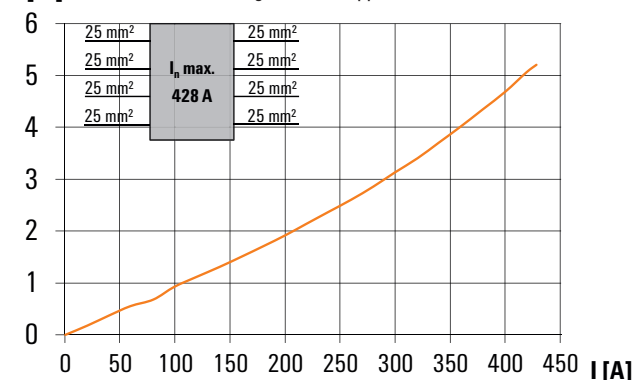

Power distribution
Screw connection

W-Series
WPD 103 2X70/2X50



WPD 103

70 mm²



Width / Height / Depth	mm
max. current / max. conductor	A/mm ²
max. clamping range	mm ²

32.9 / 53.1 / 63	
192 / 70	
4...70	

Technical data

Rated data	
Rated voltage	V
Rated current	A
for wire cross-section	70 mm ² mm ²
Rated impulse withstand voltage / Pollution severity	
Overvoltage category / UL 94 flammability rating	
Approvals	

Clamped conductors (H05V/H07V)	
Solid / Stranded	70 mm ² mm ²
	50 mm ² mm ²
Flexible with ferrule	70 mm ² mm ²
	50 mm ² mm ²
Stripping length / Blade size	70 mm ² mm/-
	50 mm ² mm/-
Tightening torque	Nm

Note

IEC 60947-7-1

IEC	UL	CSA	EN 60079-7
1000	600		
300	115		
70	AWG 12...2/0		
	8 kV / 3		
	III / V-0		



Rated connection	
10...70 / 10...70	
6...50 / 6...50	
6...50	
4...35	
25 / M10 (SW 4)	
20 / M8 (SW 4)	

see appendix at the end of the chapter
I_{max}: 320 A with the connection of 4 x 50 mm²



Ordering data

Version	
	light grey
	blue
	green
	brown
	black

Note

Type	Qty.	Order No.
WPD 103 2X70/2X50 GY	3	1561770000
WPD 103 2X70/2X50 BL	3	1561780000
WPD 103 2X70/2X50 GN	3	1561790000
WPD 103 2X70/2X50 BN	3	1561820000
WPD 103 2X70/2X50 BK	3	1561830000

Accessories

End bracket	
	dark beige
	dark beige
Screwdriver	
	SET

Type	Qty.	Order No.
WEW 35/2	100	1061200000
AEB 35 SC/1	50	1991920000
SK WSD-S 1,5-10,0	1	9008850000



Conductor connection data according to VDE 0603-2 (Cu), IEC 60947-7-1 (Cu), IEC 61238-1 Class A (Cu+Al)

Input (x2) / Output (x2)	Copper		Aluminium
2x70 mm ² (round conductor)			
70 mm ²	10 Nm	10 Nm	18 Nm
50 mm ²			10 Nm
35 mm ²			8 Nm
25 mm ²			6 Nm
16 mm ²			4 Nm
10 mm ²			
6 mm ²			
4 mm ²			
Stripping lengths	25 mm		
screw	M10 (SW 4 mm)		

Input (x2) / Output (x2)	Copper		Aluminium	
2x90 mm ² (round conductor)				
70 mm ²	6 Nm	6 Nm	10 Nm	
50 mm ²			8 Nm	
35 mm ²			6 Nm	
25 mm ²			4 Nm	
16 mm ²				
10 mm ²				
6 mm ²				
4 mm ²				
Stripping lengths	20 mm			
screw	M8 (SW 4 mm)			

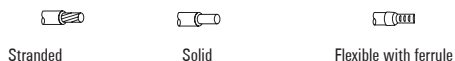

Conductor connection data according to UL 1059 (Al+Cu)

Input (line)	Line		Load		
	Copper	Aluminium	Copper	Aluminium	
AWG 4	88.5 Lb In	88.5 Lb In	159 Lb In		
AWG 6			88.5 Lb In	88.5 Lb In	
AWG 8			70.8 Lb In	70.8 Lb In	
AWG 10			53 Lb In	53.1 Lb In	
AWG 12				53.1 Lb In	
AWG 14				35 Lb In	
AWG 16					
max. current	160 A	150 A	135 A	150 A	
max. current			115 A	120 A	
Voltage size B,C (UR)	600 V				

CSA Rating data according to CSA 22.2 No. 158

Input (line)	Line		Load		
	Copper	Aluminium	Copper	Aluminium	
AWG 4	10 Nm	10 Nm	18 Nm		
AWG 6			10 Nm	10 Nm	
AWG 8			8 Nm	8 Nm	
AWG 10			6 Nm	6 Nm	
AWG 12				6 Nm	
AWG 14				4 Nm	
AWG 16					
max. current	160 A	150 A	135 A	150 A	
max. current			115 A	120 A	
Voltage size B,C (UR)	600 V				

WPD 103

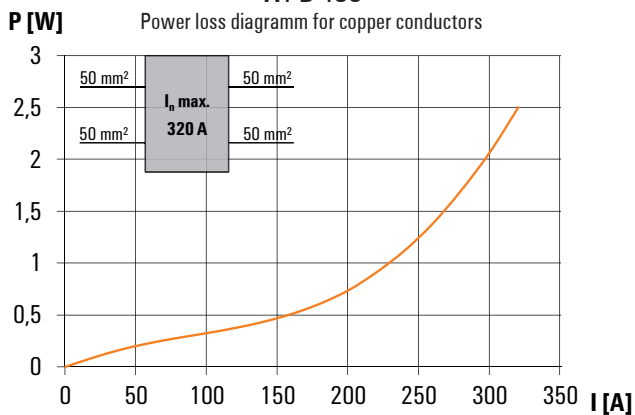

Power distribution
Screw connection

W-Series
WPD 104 1X25+1X16/2X16+3X10



Width / Height / Depth	mm
max. current / max. conductor	A/mm ²
max. clamping range	mm ²

Technical data

Rated data	
Rated voltage	V
Rated current	A
for wire cross-section	25 mm ² mm ²
Rated impulse withstand voltage / Pollution severity	
Overvoltage category / UL 94 flammability rating	
Approvals	
Clamped conductors (H05V/H07V)	
Solid / Stranded	25 mm ² mm ²
	16 mm ² mm ²
	10 mm ² mm ²
Flexible with ferrule	25 mm ² mm ²
	16 mm ² mm ²
	10 mm ² mm ²
Stripping length / Blade size	25 mm ² mm/-
	16 mm ² mm/-
	10 mm ² mm/-
Tightening torque	Nm
Note	

Ordering data

Version	
	grey
	blue
	red
	black
Note	

Accessories

Cross connection	
	2-pole
	3-pole
End bracket	
	dark beige
	dark beige
Screwdriver	
	SET

WPD 104

25 mm²



31.5 / 49 / 68	10 mm ²	16 mm ²	16 mm ²	25 mm ²
101 / 25				
1.5...25				

IEC 60947-7-1

II 2 GD
Ex eb IIC Gb

IEC	UL	CSA	EN 60079-7
1000	600	600	550
164	85	85	101
25	AWG 16...4	AWG 16...4	25
8 kV / 3			
III / V-0			
CE ENEC ERI CC UL UK Ex CNEC 16 ATEX0005U			
Rated connection			
2.5...25 / 2.5...25			
1.5...16 / 1.5...16			
1.5...10 / 1.5...10			
1.5...16			
1.5...10			
1.5...6			
12 / M5			
14 / M6			
19 / M6			
see appendix at the end of the chapter			

Type	Qty.	Order No.
WPD 104 1X25+1X16/2X16+3X10 GY	1	1562000000
WPD 104 1X25+1X16/2X16+3X10 BL	1	2518250000
WPD 104 1X25+1X16/2X16+3X10 RD	1	2725260000
WPD 104 1X25+1X16/2X16+3X10 BK	1	2725360000

Type	Qty.	Order No.
WQB WPD X04/2	20	1561980000
WQB WPD X04/3	20	1561990000
WEW 35/2	100	1061200000
AEB 35 SC/1	50	1991920000
SDK PZ2 X 100	1	2749450000
SK WSD-S 1,5-10,0	1	9008850000

WPD 204

25 mm²



63 / 49 / 68	10 mm ²	16 mm ²	16 mm ²	25 mm ²
101 / 25				
1.5...25				

IEC 60947-7-1

IEC	UL	CSA	EN 60079-7
1000			
164			
25			
8 kV / 3			
III / V-0			
CE ENEC			
Rated connection			
2.5...25 / 2.5...25			
1.5...16 / 1.5...16			
1.5...10 / 1.5...10			
1.5...16			
1.5...10			
1.5...6			
12 / M5			
14 / M6			
19 / M6			
see appendix at the end of the chapter			

Type	Qty.	Order No.
WPD 204 2X25/4X16+6X10 2XGY	1	1562150000
WPD 204 2X25/4X16+6X10 2XBL	1	2518330000
WPD 204 2X25/4X16+6X10 2XRD	1	2725290000
WPD 204 2X25/4X16+6X10 2XBK	1	2725390000

Type	Qty.	Order No.
WEW 35/2	100	1061200000
AEB 35 SC/1	50	1991920000
SDK PZ2 X 100	1	2749450000
SK WSD-S 1,5-10,0	1	9008850000

WPD 304

25 mm²

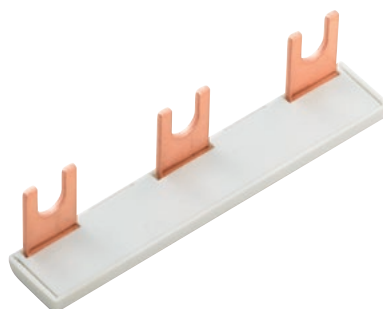
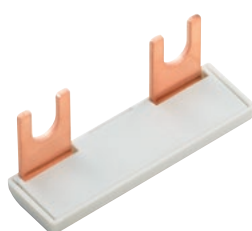

94.5 / 49 / 68
101 / 25
1.5...25



IEC 60947-7-1

IEC	UL	CSA	EN 60079-7
1000	600	600	550
164	85	85	101
25	AWG 16...4	AWG 16...4	25
8 kV / 3			
III / V-0			

CE EAC

Rated connection

2.5...25 / 2.5...25

1.5...16 / 1.5...16

1.5...10 / 1.5...10

1.5...16

1.5...10

1.5...6

12 / M5

14 / M6

19 / M6

see appendix at the end of the chapter

Type	Qty.	Order No.
WPD 304 3X25/6X16+9X10 3XGY	1	1562160000
WPD 304 3X25/6X16+9X10 3XBL	1	2518340000
WPD 304 3X25/6X16+9X10 3XRD	1	2725300000
WPD 304 3X25/6X16+9X10 3XBK	1	2725400000

Type	Qty.	Order No.
WEW 35/2	100	1061200000
AEB 35 SC/1	50	1991920000
SDK PZ2 X 100	1	2749450000
SK WSD-S 1,5-10,0	1	9008850000



Power distribution
Screw connection

Conductor connection data according to IEC 60947-7-1 (Cu)

Input	connection point A			
	Copper		Aluminium*	
25 mm ²	2,5 Nm	2,5 Nm	5,1 Nm	5,1 Nm
16 mm ²				
10 mm ²				
6 mm ²				
4 mm ²				
2,5 mm ²				
1,5 mm ²				
Stripping lengths	19 mm			
Allen screw	M6			
* Values according to UL 1059				

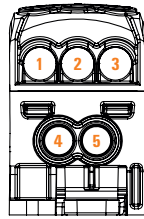

output

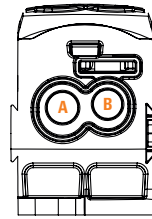

input

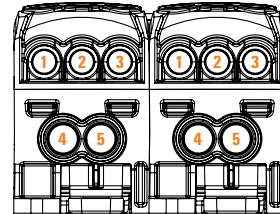

output

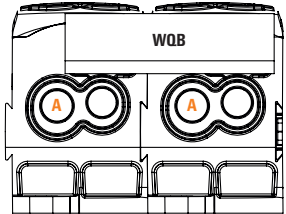

input





Output	connection point 1/2/3				connection point 4/5				connection point B			
	Copper		Aluminium*		Copper		Aluminium*		Copper		Aluminium*	
16 mm ²	2 Nm	2 Nm	5,1 Nm	2,5 Nm	2,5 Nm	5,1 Nm	5,1 Nm	2,5 Nm	2,5 Nm	5,1 Nm	2,5 Nm	2,5 Nm
10 mm ²												
6 mm ²												
4 mm ²												
2,5 mm ²												
1,5 mm ²												
Stripping lengths	12 mm				14 mm				19 mm			
Allen screw	M5				M6				M6			
* Values according to UL 1059												

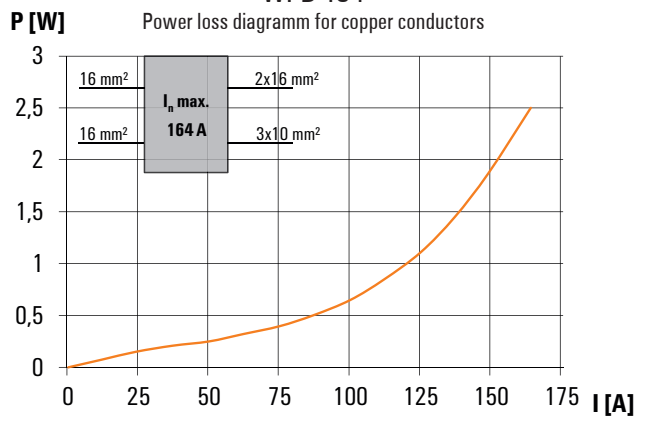













WPD 104



Conductor connection data according to UL 1059 (Al+Cu)

Certificate no. (UR)		XCFR2.E60693			
		connection point A			
Input (line)		Copper		Aluminium	
					
AWG 4	22.1 Lb In.			45.1 Lb In.	45.1 Lb In.
AWG 6					
AWG 8					
AWG 10					
AWG 12		22.1 Lb In.			
max. current	85 A	65 A	65 A	50 A	
Voltage size B,C (UR)	600 V				

output (load)	connection point 1/2/3				connection point 4/5				connection point B			
	Copper		Aluminium		Copper		Aluminium		Copper		Aluminium	
												
AWG 4	22.1 Lb In.	22.1 Lb In.	45.1 Lb In.	22.1 Lb In.	22.1 Lb In.	22.1 Lb In.	45.1 Lb In.	45.1 Lb In.	22.1 Lb In.	22.1 Lb In.	45.1 Lb In.	45.1 Lb In.
AWG 6												
AWG 8												
AWG 10												
AWG 12												
AWG 14												
AWG 16												
max. current	65 A	50 A	50 A		85 A	65 A	65 A	50 A	65 A	50 A	50 A	
Voltage size B,C (UR)	600 V											



Mehrdrätig

Eindrätig

Feindrätig mit Aderendhülse

CSA Rating data according to CSA 22.2 No. 158

Certificate No. (CSA)		269832			
	Input		Output		
	CP* A	CP* 1/2/3	CP* 4/5	CP*B	
AWG 4	2,5 Nm.	2,5 Nm	2,5 Nm	2,5 Nm	
AWG 6					
AWG 8					
AWG 10					
AWG 12					
AWG 14					
AWG 16					
max. current	85 A	50 A	50 A	65 A	
Voltage size C (CSA)	600 V				

* CP - connection point



Power distribution
Screw connection

W-Series
WPD 105 1X35+1X16/2X25+3X16



Width / Height / Depth	mm
max. current / max. conductor	A/mm ²
max. clamping range	mm ²

Technical data

Rated data	
Rated voltage	V
Rated current	A
for wire cross-section	35 mm ² mm ²
Rated impulse withstand voltage / Pollution severity	
Overvoltage category / UL 94 flammability rating	
Approvals	

Clamped conductors (H05V/H07V)	
Solid / Stranded	35 mm ² mm ²
	25 mm ² mm ²
	16 mm ² mm ²
Flexible with ferrule	35 mm ² mm ²
	25 mm ² mm ²
	16 mm ² mm ²
Stripping length / Blade size	35 mm ² mm/-
	25 mm ² mm/-
	16 mm ² mm/-
Tightening torque	Nm

Note

Ordering data

Version	grey	blue	red	black

Note

Accessories

Cross connection	
	2-pole
	3-pole
End bracket	
	dark beige
	dark beige
Screwdriver	
	SET

WPD 105

35 mm²



35.6 / 53.7 / 70	16 mm ²	16 mm ²	16 mm ²	35 mm ²
125 / 35				
1.5...35				

IEC 60947-7-1

Ex II 2 GD
Ex eb IIC Gb

IEC	UL	CSA	EN 60079-7
1000	600	600	690
214	115	85	125
35	AWG 16...2	AWG 16...2	35
8 kV / 3			
III / V-0			

CE ENEC ERI CC FUL UK Ex CNEC 16 ATEX0005U

Rated connection	
4...35 / 4...35	
2.5...25 / 2.5...25	
1.5...16 / 1.5...16	
2.5...25	
1.5...16	
1.5...10	
19 / M8	
14 / M6	
12 / M6	

see appendix at the end of the chapter

Type	Qty.	Order No.
WPD 105 1X35+1X16/2X25+3X16 GY	1	1562170000
WPD 105 1X35+1X16/2X25+3X16 BL	1	2518540000
WPD 105 1X35+1X16/2X25+3X16 RD	1	2725310000
WPD 105 1X35+1X16/2X25+3X16 BK	1	2725410000

Type	Qty.	Order No.
WQB WPD X05/2	20	1561960000
WQB WPD X05/3	20	1561970000
WEW 35/2	100	1061200000
AEB 35 SC/1	50	1991920000
SDK PZ2 X 100	1	2749450000
SK WSD-S 1,5-10,0	1	9008850000

WPD 205

35 mm²



71.2 / 53.7 / 70	16 mm ²	16 mm ²	16 mm ²	35 mm ²
125 / 35				
1.5...35				

IEC 60947-7-1

IEC	UL	CSA	EN 60079-7
1000			
214			
35			
8 kV / 3			
III / V-0			

CE ENEC

Rated connection	
4...35 / 4...35	
2.5...25 / 2.5...25	
1.5...16 / 1.5...16	
2.5...25	
1.5...16	
1.5...10	
19 / M8	
14 / M6	
12 / M6	

see appendix at the end of the chapter

Type	Qty.	Order No.
WPD 205 2X35/4X25+6X16 2XGY	1	1562180000
WPD 205 2X35/4X25+6X16 2XBL	1	2519470000
WPD 205 2X35/4X25+6X16 2XRD	1	2725320000
WPD 205 2X35/4X25+6X16 2XBK	1	2725420000

Type	Qty.	Order No.
WEW 35/2	100	1061200000
AEB 35 SC/1	50	1991920000
SDK PZ2 X 100	1	2749450000
SK WSD-S 1,5-10,0	1	9008850000

WPD 305

35 mm²

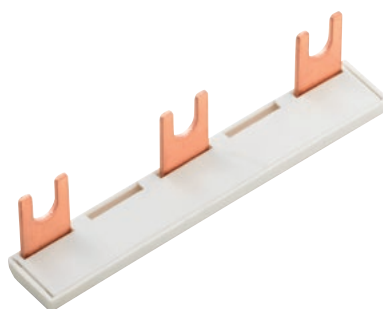
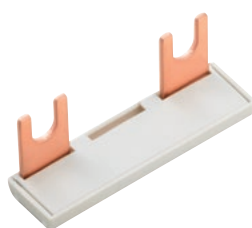

106.8 / 53.7 / 70
125 / 35
1,5...35

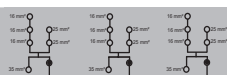

IEC 60947-7-1

IEC	UL	CSA	EN 60079-7
1000			
214			
35			
		8 kV / 3	
		III / V-0	

CE EAC

Rated connection

4...35 / 4...35
2.5...25 / 2.5...25
1.5...16 / 1.5...16
2.5...25
1.5...16
1.5...10
19 / M8
14 / M6
12 / M6

see appendix at the end of the chapter

Type	Qty.	Order No.
WPD 305 3X35/6X25+9X16 3XGY	1	1562190000
WPD 305 3X35/6X25+9X16 3XBL	1	2521770000
WPD 305 3X35/6X25+9X16 3XRD	1	2725330000
WPD 305 3X35/6X25+9X16 3XBK	1	2725430000

Type	Qty.	Order No.
WEW 35/2	100	1061200000
AEB 35 SC/1	50	1991920000
SDK PZ2 X 100	1	2749450000
SK WSD-S 1,5-10,0	1	9008850000



Power distribution
Screw connection

Conductor connection data according to IEC 60947-7-1 (Cu)

Input	connection point A			
	Copper		Aluminium*	
35 mm ²	3,5 Nm	3,5 Nm	11,3 Nm	11,3 Nm
25 mm ²				
16 mm ²				
10 mm ²				
6 mm ²				
4 mm ²				
2.5 mm ²				
Stripping lengths	19 mm			
Allen screw	M8			
* Values according to UL 1059				

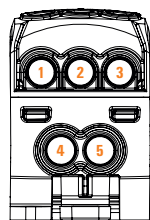

output

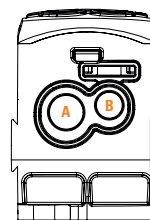

input

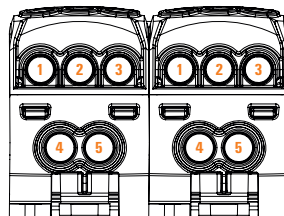

output

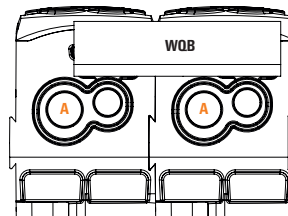

input

Output	connection point 1/2/3				connection point 4/5				connection point B			
	Copper		Aluminium*		Copper		Aluminium*		Copper		Aluminium*	
25 mm ²	2 Nm	2 Nm	5,1 Nm	5,1 Nm	2,5 Nm	2,5 Nm	5,1 Nm	5,1 Nm	2,5 Nm	2,5 Nm	5,1 Nm	5,1 Nm
16 mm ²												
10 mm ²												
6 mm ²												
4 mm ²												
2.5 mm ²												
1.5 mm ²												
Stripping lengths	12 mm				14 mm				19 mm			
Allen screw	M6				M6				M6			
* Values according to UL 1059												



Stranded



Solid



Flexible with ferrule







Sector shaned

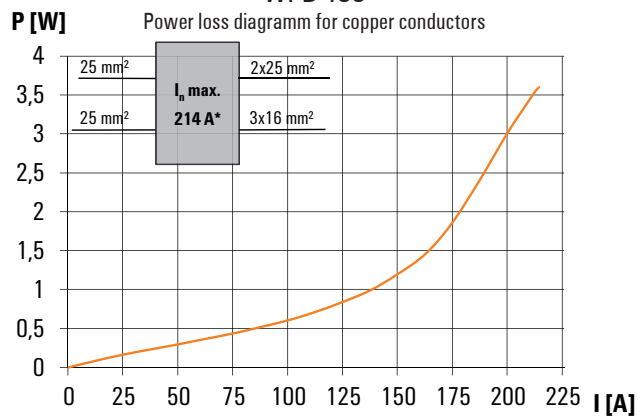











WPD 105

Power loss diagramm for copper conductors



Conductor connection data according to UL 1059 (Al+Cu)

Certificate no. (UR)		XCFR2.E60693			
connection point A					
Input (line)	Copper		Aluminium		
					
AWG 2	31 Lb In.	31 Lb In.	100 Lb In.	100 Lb In.	
AWG 4					
AWG 6					
AWG 8					
AWG 10					
AWG 12					
max. current	115 A	85 A	90 A	65 A	
Voltage size B,C (UR)	600 V				

output (load)	connection point 1/2/3				connection point 4/5				connection point B			
	Copper		Aluminium		Copper		Aluminium		Copper		Aluminium	
												
AWG 4	22.1 Lb In.	22.1 Lb In.	45.1 Lb In.	22.1 Lb In.	22.1 Lb In.	22.1 Lb In.	45.1 Lb In.	45.1 Lb In.	22.1 Lb In.	22.1 Lb In.	45.1 Lb In.	50 A
AWG 6												
AWG 8												
AWG 10												
AWG 12												
AWG 14												
max. current	65 A	50 A	50 A	85 A	65 A	65 A	50 A	65 A	50 A	50 A	50 A	
Voltage size B,C (UR)	600 V											

 Stranded
  Solid
  Flexible with ferrule
  Sector shaped

CSA Rating data according to CSA 22.2 No. 158

Certificate No. (CSA)		269832			
	Input		Output		
	CP* A	CP* 1/2/3	CP* 4/5	CP*B	
AWG 4	31 Lb In.	22.1 Lb In.	22.1 Lb In.	22.1 Lb In.	22.1 Lb In.
AWG 4					
AWG 6					
AWG 8					
AWG 10					
AWG 12					
AWG 14					
AWG 16					
max. current	115 A	85 A	85 A	85 A	
Voltage size C (CSA)	600 V				

* CP - connection point



Power distribution
Screw connection

W-Series
WPD 106 1X70/2X25+3X16



WPD 106 70 mm²



Width / Height / Depth	mm
max. current / max. conductor	A/mm ²
max. clamping range	mm ²

39.5 / 50.4 / 70	16 mm ²	15.5 x 5	70 mm ²
192 / 70	25 mm ²		
1.5...70			

Technical data

Rated data	
Rated voltage	V
Rated current	A
for wire cross-section	70 mm ² mm ²
Rated impulse withstand voltage / Pollution severity	
Overvoltage category / UL 94 flammability rating	
Approvals	
Clamped conductors (H05V/H07V)	
Solid / Stranded	70 mm ² mm ²
	25 mm ² mm ²
	16 mm ² mm ²
Flexible with ferrule	70 mm ² mm ²
	25 mm ² mm ²
	16 mm ² mm ²
Stripping length / Blade size	70 mm ² mm/-
	25 mm ² mm/-
	16 mm ² mm/-
Tightening torque	Nm
Note	

IEC 60947-7-1

IEC	UL	CSA	EN 60079-7
1000		600	550
215		175	160
70		AWG 16...2/0	70
8 kV / 3			
III / V-0			
CE ENEC ERI CC UK Ex II 2 GD Ex eb IIC Gb			
CNEC 16 ATEX0005U			
Rated connection			
10...70 / 10...70			
2.5...25 / 2.5...25			
1.5...16 / 1.5...16			
6...50			
1.5...16			
1.5...10			
19 / M8			
14 / M6			
12 / M6			
see appendix at the end of the chapter			

Ordering data

Version	Color
	grey
	blue
	red
	black
Note	

Type	Qty.	Order No.
WPD 106 1X70/2X25+3X16 GY	1	1562210000
WPD 106 1X70/2X25+3X16 BL	1	2518570000
WPD 106 1X70/2X25+3X16 RD	1	2725340000
WPD 106 1X70/2X25+3X16 BK	1	2725440000

Accessories

Accessories	Color
Cross connection	2-pole
End bracket	dark beige
	dark beige
Screwdriver	SET

Type	Qty.	Order No.
WQB WPD X06/2	20	1561940000
WEW 35/2	100	1061200000
AEB 35 SC/1	50	1991920000
SDK PZ2 X 100	1	2749450000
SK WSD-S 1,5-10,0	1	9008850000

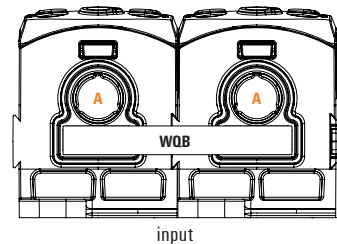
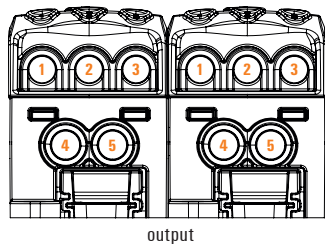
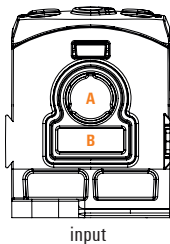
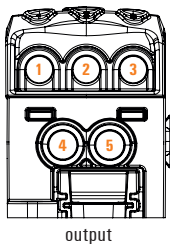

Conductor connection data according to IEC 60947-7-1 (Cu)

Input	connection point A				CP** B Copper
	Copper		Aluminium*		
70 mm ²	10 Nm	10 Nm	13,6 Nm	13,6 Nm	
50 mm ²					
35 mm ²					
25 mm ²					
16 mm ²					
10 mm ²					
6 mm ²					
Flat band 15,5x5 mm					2 Nm
Stripping lengths	19 mm				17 mm
Allen screw	M8				M5

* Values according to UL 1059 ** CP - connection point

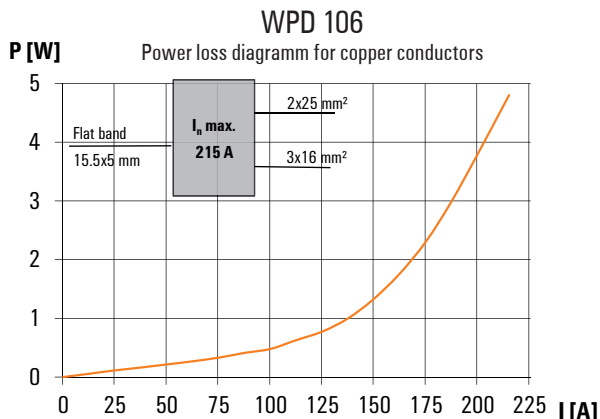

Output	connection point 1/2/3				connection point 4/5			
	Copper		Aluminium*		Copper		Aluminium*	
25 mm ²	2 Nm	2 Nm	5,1 Nm		2,5 Nm	2,5 Nm	5,1 Nm	5,1 Nm
16 mm ²								
10 mm ²								
6 mm ²								
4 mm ²								
2,5 mm ²								
1,5 mm ²								
Stripping lengths	12 mm				14 mm			
Allen screw	M6				M6			

* Values according to UL 1059



Conductor connection data according to UL 1059 (Al+Cu)

Certificate no. (UR)	XCFR2.E60693				CP** B Copper
	connection point A				
AWG 2/0	88.5 Lb In.	88.5 Lb In.	120.4 Lb In.	100 Lb In.	
AWG 1/0					
AWG 2					
AWG 4					
AWG 6					
AWG 8					
AWG 10					
Flat band 15.5x3.2 mm					17.4 Lb In.
max. current	160 A	150 A	135 A	120 A	160 A
Voltage size B,C (UR)	600 V				

** CP - connection point

CSA rating data according to CSA 22.2 No. 158

Certificate No. (CSA)	269832					
	Input	Output				
	CP* A	CP* 1/2/3	CP* 4/5			
AWG 2/0	10 Nm.					
AWG 1/0						
AWG 2						
AWG 4						
AWG 6						
AWG 8						
AWG 10	2 Nm	2 Nm				
AWG 12						
AWG 14						
AWG 16						
max. current				175 A	50 A	65 A
Voltage size C (CSA)				600 V		

* CP - connection point

output (load)	connection point 1/2/3				connection point 4/5			
	Copper		Aluminium		Copper		Aluminium	
AWG 4	22.6 Lb In.	22.6 Lb In.	45.1 Lb In.		22.6 Lb In.	22.6 Lb In.	45.1 Lb In.	45.1 Lb In.
AWG 6								
AWG 8								
AWG 10								
AWG 12								
AWG 14								
AWG 16								
max. current	65 A	50 A	50 A		85 A	65 A	65 A	50 A
Voltage size B,C (UR)	600 V							

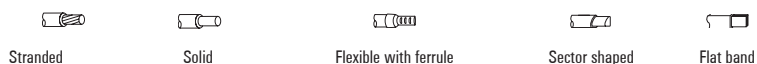

Power distribution
Screw connection

W-Series
WPD 107 1X95/2X35+8X25



WPD 107

95 mm²



Width / Height / Depth	mm
max. current / max. conductor	A/mm ²
max. clamping range	mm ²

51 / 54.5 / 73	
232 / 95	
1,5...95	

Technical data

Rated data	
Rated voltage	V
Rated current	A
for wire cross-section	95 mm ² mm ²
Rated impulse withstand voltage / Pollution severity	
Overvoltage category / UL 94 flammability rating	
Approvals	
Clamped conductors (H05V/H07V)	
Solid / Stranded	95 mm ² mm ²
	35 mm ² mm ²
	25 mm ² mm ²
Flexible with ferrule	95 mm ² mm ²
	35 mm ² mm ²
	25 mm ² mm ²
Stripping length / Blade size	95 mm ² mm/-
	35 mm ² mm/-
	25 mm ² mm ²
Tightening torque	Nm
Note	

IEC 60947-7-1

IEC	UL	CSA	EN 60079-7
1000			440
270			232
95			95
8 kV / 3			
III / V-0			

Ex II 2 GD
Ex eb IIC Gb

CE	Ex	CNEX 16 ATEX0005U
Rated connection		
16...95 / 16...95		
4...35 / 4...35		
2.5...25 / 2.5...25		
10...70		
2.5...25		
1.5...16		
14 / M12		
12 / M8		
12 / M6		
see appendix at the end of the chapter		

Ordering data

Version	grey
	blue
	red
	black
Note	

Type	Qty.	Order No.
WPD 107 1X95/2X35+8X25 GY	1	1562220000
WPD 107 1X95/2X35+8X25 BL	1	2521730000
WPD 107 1X95/2X35+8X25 RD	1	2725350000
WPD 107 1X95/2X35+8X25 BK	1	2725450000

Accessories

End bracket	dark beige
	dark beige
Screwdriver	SET

Type	Qty.	Order No.
WEW 35/2	100	1061200000
AEB 35 SC/1	50	1991920000
SDK PZ2 X 100	1	2749450000
SK WSD-S 1,5-10,0	1	9008850000

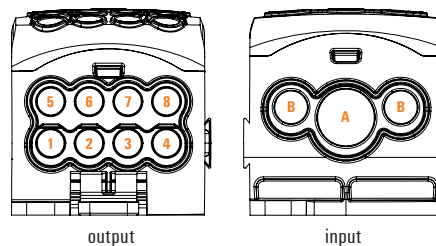

Conductor connection data according to IEC 60947-7-1 (Cu)

Input	connection point A			
	Copper		Aluminium*	
95 mm ²	14 Nm	14 Nm	22,6 Nm	22,6 Nm
70 mm ²				
50 mm ²				
35 mm ²				
25 mm ²				
16 mm ²				
10 mm ²				
Stripping lengths	14 mm			
Allen screw	M12			
* Values according to UL 1059				

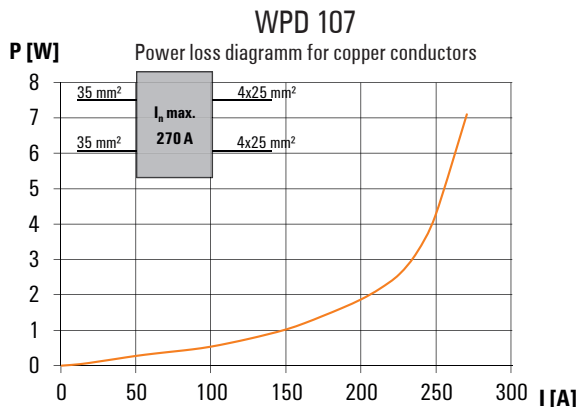

Output	connection point 1 - 8				connection point B			
	Copper		Aluminium*		Copper		Aluminium*	
35 mm ²	2,5 Nm	2,5 Nm	5,1 Nm	5,1 Nm	3,5 Nm	3,5 Nm	11,3 Nm	11,3 Nm
25 mm ²								
16 mm ²								
10 mm ²								
6 mm ²								
4 mm ²								
2.5 mm ²								
1.5 mm ²								
Stripping lengths	12 mm				12 mm			
Allen screw	M6				M8			
* Values according to UL 1059								



Conductor connection data according to UL 1059 (Al+Cu)

Certificate no. (UR)	XCFR2.E60693			
	connection point A			
Input (line)	Copper		Aluminium	
AWG 3/0	124 Lb In.	124 Lb In.	200 Lb In.	200 Lb In.
AWG 2/0				
AWG 1/0				
AWG 2				
AWG 4				
AWG 6				
AWG 8				
max. current	200 A	175 A	155 A	130 A
Voltage size B,C (UR)	600 V			

CSA rating data according to CSA 22.2 No. 158

Certificate No. (CSA)	269832		
	Input	Output	
	CP* A	CP* 1 - 8	CP* B
AWG 3/0	14 Nm.		
AWG 2/0			
AWG 1/0			
AWG 2			
AWG 4			
AWG 6			
AWG 8	2,5 Nm	6 Nm	
AWG 10			
AWG 12			
AWG 14			
max. current	200 A	85 A	115 A
Voltage size C (CSA)	600 V		
* CP - connection point			

output (load)	connection point 1 - 8				connection point B			
	Copper		Aluminium		Copper		Aluminium	
AWG 2	22.1 Lb In.	22.1 Lb In.	45.1 Lb In.	45.1 Lb In.	31 Lb In.	31 Lb In.	100 Lb In.	100 Lb In.
AWG 4								
AWG 6								
AWG 8								
AWG 10								
AWG 12								
AWG 14								
AWG 16								
max. current	85 A	65 A	65 A	50 A	115 A	85 A	90 A	65 A
Voltage size B,C (UR)	600 V							

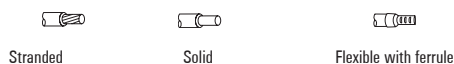

Power distribution
Screw connection

W-Series
WPD 108 1X120/2X35+3X25+4X16



Width / Height / Depth	mm
max. current / max. conductor	A/mm ²
max. clamping range	mm ²

Technical data

Rated data	
Rated voltage	V
Rated current	A
for wire cross-section	120 mm ² mm ²
Rated impulse withstand voltage / Pollution severity	
Overvoltage category / UL 94 flammability rating	
Approvals	
Clamped conductors (H05V/H07V)	
Solid / Stranded	120 mm ² mm ²
	35 mm ² mm ²
	25 mm ² mm ²
	16 mm ² mm ²
Flexible with ferrule	120 mm ² mm ²
	35 mm ² mm ²
	25 mm ² mm ²
	16 mm ² mm ²
Stripping length / Blade size	120 mm ² mm/-
	35 mm ² mm/-
	25 mm ² mm ²
	16 mm ² mm ²
Tightening torque	Nm
Note	

Ordering data

Version	Color
	grey
	blue
	red
	black
Note	

Accessories

Cross connection	2-pole
End bracket	dark beige
	dark beige
Screwdriver	SET

WPD 108

120 mm²



51.1 / 77 / 95	16 mm ²	24 x 10
269 / 120	25 mm ²	120 mm ²
1.5...120	35 mm ²	

IEC 60947-7-1

Ex II 2 GD
Ex eb IIC Gb



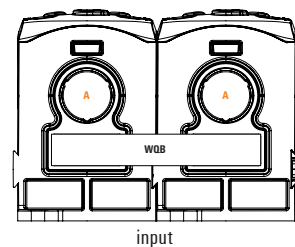
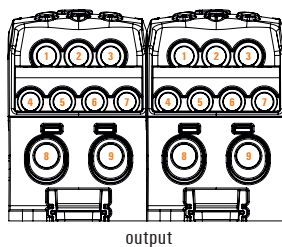
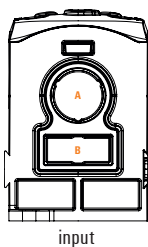
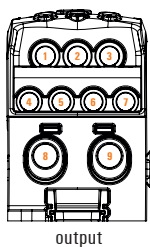

IEC	UL	CSA	EN 60079-7
1000			880
400			250
120			120
8 kV / 3			
III / V-0			
CE Ex Ex			
CNEX 16 ATEX0005U			
Rated connection			
35...120 / 35...120			
4...35 / 4...35			
2.5...25 / 2.5...25			
1.5...16 / 1.5...16			
2.5...95			
2.5...25			
1.5...16			
1.5...10			
27 / M14			
18 / M8			
12 / M6			
12 / M6			
see appendix at the end of the chapter			

Type	Qty.	Order No.
WPD 108 1X120/2X35+3X25+4X16 GY	1	1562100000
WPD 108 1X120/2X35+3X25+4X16 BL	1	2519480000
WPD 108 1X120/2X35+3X25+4X16 RD	1	2725280000
WPD 108 1X120/2X35+3X25+4X16 BK	1	2725380000

Type	Qty.	Order No.
WQB WPD X08-09/2	20	1561900000
WEW 35/2	100	1061200000
AEB 35 SC/1	50	1991920000
SDK PZ2 X 100	1	2749450000
SK WSD-S 1,5-10,0	1	9008850000









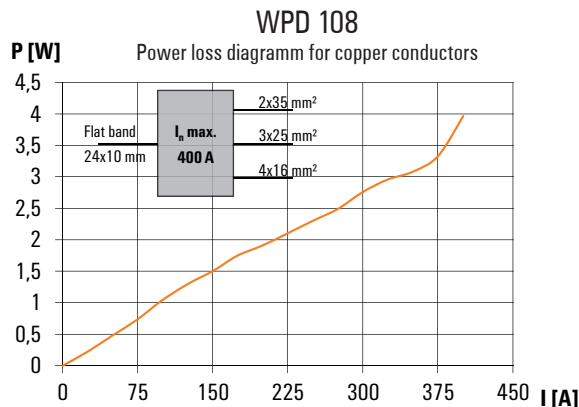





Conductor connection data according to IEC 60947-7-1 (Cu)

Input	connection point A				CP* B Copper
	Copper		Aluminium*		
120 mm ²					
95 mm ²	19 Nm	19 Nm	22,6 Nm	22,6 Nm	
70 mm ²					
50 mm ²					
35 mm ²					
25 mm ²					
Flat band 24x10mm					3 Nm
Stripping lengths	27 mm				22 mm
Allen screw	M14				M6

* Values according to UL 1059 ** CP - connection point





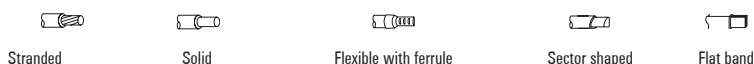

Output	connection point 1 / 2 / 3				connection point 4 / 5 / 6 / 7				connection point 8 / 9			
	Copper		Aluminium*		Copper		Aluminium*		Copper		Aluminium*	
35 mm ²												
25 mm ²	2 Nm	2 Nm	5,1 Nm	5,1 Nm	2 Nm	2 Nm	5,1 Nm	2,5 Nm	2,5 Nm	11,3 Nm	11,3 Nm	
16 mm ²												
10 mm ²												
6 mm ²												
4 mm ²												
2.5 mm ²												
1.5 mm ²												
Stripping lengths	12 mm				12 mm				18 mm			
Allen screw	M6				M6				M8			

* Values according to UL 1059



Conductor connection data according to UL 1059 (Al+Cu)













Certificate no. (UR)	XCFR2.E60693				CP* B Copper
	connection point A				
Input (line)	Copper		Aluminium		
kcmil 250					
AWG 4/0	168.2 Lb In.	168.2 Lb In.	200 Lb In.	200 Lb In.	
AWG 3/0					
AWG 2/0					
AWG 1/0					
AWG 2					
AWG 4					
Flat band 24x10 mm					
max. current	250 A	200 A	155 A	205 A	250 A
Voltage size B,C (UR)	600 V				

* CP - connection point

CSA rating data according to CSA 22.2 No. 158

Certificate No. (CSA)	269832			
	Input	Output		
	CP* A	CP* 1/2/3	CP* 4/5/6/7	CP* B
kcmil 250	19 Nm.			
AWG 2	19 Nm			
AWG 2	3 Nm	3 Nm	6 Nm	
AWG 4				
AWG 6				
AWG 8				
AWG 10				
AWG 12				
AWG 14				
AWG 16				
max. current	255 A	85 A	65 A	115 A
Voltage size C (CSA)	600 V			

* CP - connection point

Output	connection point 1 / 2 / 3				connection point 4 / 5 / 6 / 7				connection point 8 / 9			
	Copper		Aluminium		Copper		Aluminium		Copper		Aluminium	
AWG 2												
AWG 4	22.6 Lb In.	22.6 Lb In.	45.1 Lb In.	45.1 Lb In.	22.6 Lb In.	22.6 Lb In.	45.1 Lb In.	53.1 Lb In.	53.1 Lb In.	100 Lb In.	100 Lb In.	
AWG 6												
AWG 8												
AWG 10												
AWG 12												
AWG 14												
AWG 16												
max. current												85 A
Voltage size B,C (UR)	600 V											



Power distribution
Screw connection

W-Series
WPD 109 1X185/2X35+3X25+4X16



Width / Height / Depth	mm
max. current / max. conductor	A/mm ²
max. clamping range	mm ²

Technical data

Rated data	
Rated voltage	V
Rated current	A
for wire cross-section	185 mm ² mm ²

Rated impulse withstand voltage / Pollution severity
Overvoltage category / UL 94 flammability rating
Approvals

Clamped conductors (H05V/H07V)		
Solid / Stranded	185 mm ²	mm ²
	35 mm ²	mm ²
	25 mm ²	mm ²
	16 mm ²	mm ²
Flexible with ferrule	185 mm ²	mm ²
	35 mm ²	mm ²
	25 mm ²	mm ²
	16 mm ²	mm ²
Stripping length / Blade size	185 mm ²	mm/-
	35 mm ²	mm/-
	25 mm ²	mm ²
	16 mm ²	mm ²
Tightening torque		Nm

Note

Ordering data

Version	
	grey
	blue
	red
	black

Note

Accessories

Cross connection	
	2-pole
End bracket	
	dark beige
	dark beige
Screwdriver	
	SET

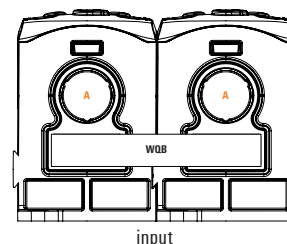
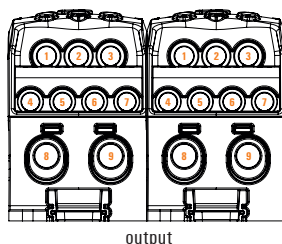
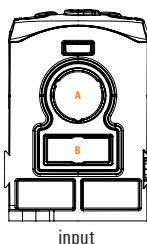
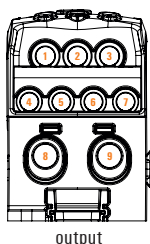

WPD 109

185 mm²



55.1 / 77 / 95	16 mm ²	24 x 10
353 / 185	25 mm ²	185 mm ²
1,5...185	35 mm ²	

IEC 60947-7-1

II 2 GD
Ex eb IIC Gb

IEC	UL	CSA	EN 60079-7
1000	600	600	880
490	310	310	353
185	AWG 16...350 kcmil	AWG 16...350 kcmil	185

8 kV / 3
III / V-0

CE ENEC ETL UL UK CNEC 16 ATEX0005U

Bemessungsanschluss

70...185 / 70...185
4...35 / 4...35
2.5...25 / 2.5...25
1.5...16 / 1.5...16
50...150
2.5...25
1.5...16
1.5...10
27 / M14
18 / M8
12 / M6
12 / M6

siehe Anhang am Kapitelende

Type	Qty.	Order No.
WPD 109 1X185/2X35+3X25+4X16 GY	1	1562090000
WPD 109 1X185/2X35+3X25+4X16 BL	1	2519490000
WPD 109 1X185/2X35+3X25+4X16 RD	1	2725270000
WPD 109 1X185/2X35+3X25+4X16 BK	1	2725370000

Type	Qty.	Order No.
WQB WPD X08-09/2	20	1561900000
WEW 35/2	100	1061200000
AEB 35 SC/1	50	1991920000
SDK PZ2 X 100	1	2749450000
SK WSD-S 1,5-10,0	1	9008850000

Conductor connection data according to IEC 60947-7-1 (Cu)

Input	connection point A				CP* B Copper
	Copper		Aluminium*		
185 mm ²	19 Nm	19 Nm	22,6 Nm	22,6 Nm	
150 mm ²					
120 mm ²					
95 mm ²					
70 mm ²					
50 mm ²					3 Nm
Flat band 24x10mm	27 mm				22 mm
Stripping lengths	M14				M6
Allen screw					

* Values according to UL 1059 ** CP - connection point

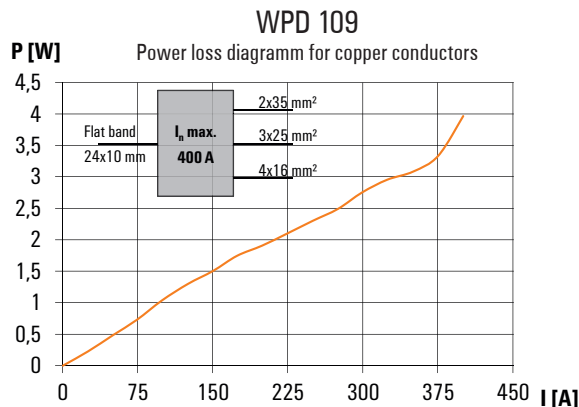

Output	connection point 1 / 2 / 3				connection point 4 / 5 / 6 / 7				connection point 8 / 9			
	Copper		Aluminium*		Copper		Aluminium*		Copper		Aluminium*	
35 mm ²	2 Nm	2 Nm	5,1 Nm	5,1 Nm	2 Nm	2 Nm	5,1 Nm	2,5 Nm	2,5 Nm	11,3 Nm	11,3 Nm	
25 mm ²												
16 mm ²												
10 mm ²												
6 mm ²												
4 mm ²												
2.5 mm ²												
1.5 mm ²												
Stripping lengths	12 mm				12 mm				18 mm			
Allen screw	M6				M6				M8			

* Values according to UL 1059

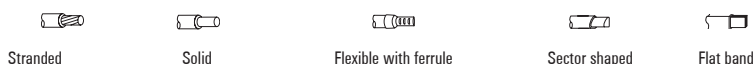

Conductor connection data according to UL 1059 (Al+Cu)

Certificate no. (UR)	XCFR2.E60693				CP* B Copper
	connection point A				
Input (line)	Copper		Aluminium		
kcmil 350	249.6 Lb In.	249.6 Lb In.	398.3 Lb In.	398.3 Lb In.	
kcmil 300					
kcmil 250					
AWG 4/0					
AWG 3/0					
AWG 2/0					17.7 Lb In.
AWG 1/0					
Flat band 24x10 mm	600 V				
max. current	310 A	285 A	250 A	230 A	250 A
Voltage size B,C (UR)					

* CP - connection point

CSA rating data according to CSA 22.2 No. 158

Certificate No. (CSA)	269832			
	Input		Output	
	CP* A	CP* 1/2/3	CP* 4/5/6/7	CP* B
kcmil 250	19 Nm.			
...				
AWG 2/0	19 Nm			
AWG 2	2Nm	2 Nm	3 Nm	
AWG 4				
AWG 6				
AWG 8				
AWG 10				
AWG 12				
AWG 14				
AWG 16				
max. current	255 A	85 A	65 A	115 A
Voltage size C (CSA)	600 V			

* CP - connection point

Output	connection point 1 / 2 / 3				connection point 4 / 5 / 6 / 7				connection point 8 / 9			
	Copper		Aluminium		Copper		Aluminium		Copper		Aluminium	
AWG 2	22.6 Lb In.	22.6 Lb In.	45.1 Lb In.	45.1 Lb In.	22.6 Lb In.	22.6 Lb In.	45.1 Lb In.	53.1 Lb In.	53.1 Lb In.	100 Lb In.	100 Lb In.	
AWG 4												
AWG 6												
AWG 8												
AWG 10												
AWG 12												
AWG 14												
AWG 16												
max. current	85 A	65 A	65 A	50 A	65 A	50 A	50 A	115 A	85 A	90 A	65 A	
Voltage size B,C (UR)	600 V											

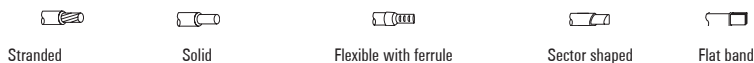

Power distribution
Screw connection

W-Series
WPD 111 1X95/4X35



WPD 111

95 mm²



Width / Height / Depth	mm
max. current / max. conductor	A/mm ²
max. clamping range	mm ²

36.6 / 69.4 / 105	
232 / 95	
2.5...95	

Technical data

Rated data		
Rated voltage	V	
Rated current	A	
for wire cross-section	95 mm ²	mm ²
Rated impulse withstand voltage / Pollution severity		
Overvoltage category / UL 94 flammability rating		
Approvals		
Clamped conductors (H05V/H07V)		
Solid / Stranded	95 mm ²	mm ²
	35 mm ²	mm ²
Flexible with ferrule	95 mm ²	mm ²
	35 mm ²	mm ²
Stripping length / Blade size	95 mm ²	mm/-
	35 mm ²	mm/-
Tightening torque	Nm	
Note		

IEC 60947-7-1

IEC	UL	CSA	EN 60079-7
1000	1000		
232	230		
95	AWG 14...4/0		
8 kV / 3			
III / V-0			



Bemessungsanschluss

16...95 / 16...95
4...35 / 4...35
10...70
2.5...25
21 / M12
16 / M8

see appendix at the end of the chapter

Ordering data

Version	
	grey
	blue
	red
	black
Note	

Type	Qty.	Order No.
WPD 111 1X95/4X35 GY	1	2603790000
WPD 111 1X95/4X35 BL	1	2603800000
WPD 111 1X95/4X35 RD	1	2730310000
WPD 111 1X95/4X35 BK	1	2730320000

Accessories

End bracket	
	dark beige
	dark beige
Screwdriver	
	SET

Type	Qty.	Order No.
WEW 35/2	100	1061200000
AEB 35 SC/1	50	1991920000
SDK PZ2 X 100	1	2749450000
SK WSD-S 1,5-10,0	1	9008850000

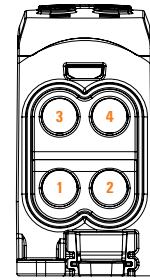



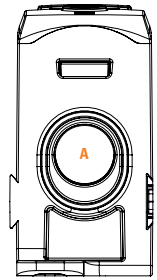

output







input







Conductor connection data according to IEC 60947-1 (Cu)





Input		connection point A Copper		Output		connection point A Copper	
1x 95 mm ²				1x 35 mm ²			
95 mm ²				35 mm ²			
70 mm ²				25 mm ²			
50 mm ²				16 mm ²			
35 mm ²		14 Nm		10 mm ²			
25 mm ²			14 Nm	6 mm ²			6 Nm
16 mm ²				4 mm ²			
10 mm ²				2,5 mm ²			
Stripping lengths	21 mm			16 mm			
Allen screw	M12			M8			

 Stranded
  Solid
  Flexible with ferrule
  Sector shaped
  Flat band

Conductor connection data according to 1059 (Al+Cu)

Certificate no. (UR) XCFR2.E60693

Input (line)	connection point A			
	Copper		Aluminium	
				
AWG 4/0	200 Lb In.	200 Lb In.	200 Lb In.	200 Lb In.
AWG 3/0				
AWG 2/0				
AWG 1/0				
AWG 1				
AWG 2				
AWG 3				
AWG 4				
AWG 6				
AWG 8				
max. current	230 A	200 A	180 A	155 A
Voltage size B,C (UR)	1000 V			

Output	connection point 1 / 2 / 3 / 4			
	Copper		Aluminium	
				
AWG 2	124.8 Lb In.	124.8 Lb In.	124.8 Lb In.	124.8 Lb In.
AWG 3				
AWG 4				
AWG 6				
AWG 8				
AWG 10				
AWG 12				
AWG 14				
max. current	115 A	100 A	90 A	75 A
Voltage size B,C (UR)	1000 V			



Power distribution
Screw connection

W-Series
WPD 113 1X185+1X150/8X35



Width / Height / Depth	mm
max. current / max. conductor	A/mm ²
max. clamping range	mm ²

Technical data

Rated data	
Rated voltage	V
Rated current	A
for wire cross-section	185 mm ² mm ²
Rated impulse withstand voltage / Pollution severity	
Overvoltage category / UL 94 flammability rating	
Approvals	

Clamped conductors (H05V/H07V)	
Solid / Stranded	185 mm ² mm ²
	150 mm ² mm ²
	35 mm ² mm ²
Flexible with ferrule	185 mm ² mm ²
	150 mm ² mm ²
	35 mm ² mm ²
Stripping length / Blade size	185 mm ² mm/-
	150 mm ² mm/-
	35 mm ² mm/-
Tightening torque	Nm

Note

Ordering data

Version	
	grey
	blue
	red
	black

Note

Accessories

End bracket	
	dark beige
	dark beige

Screwdriver	
	SET

WPD 113

185 mm²



62.6 / 80.3 / 126.3	
353 / 185	
2.5...185	

IEC 60947-7-1

IEC	UL	CSA	EN 60079-7
1000	1000		
353	310		
185	AWG 14...350 kcmil		
8 kV / 3			
III / V-0			



Rated connection	
	50...150
	70...150 / 70...150
	4...35 / 4...35
	70...185 / 70...185
	50...120 / 50...120
	2.5...25
	33 / M16
	28 / M16
	16 / M8
	siehe Anhang am Kapitelende



Type	Qty.	Order No.
WPD 113 1X185+1X150/8X35 GY	1	2603740000
WPD 113 1X185+1X150/8X35 BL	1	2603750000
WPD 113 1X185+1X150/8X35 RD	1	2730350000
WPD 113 1X185+1X150/8X35 BK	1	2730360000

Type	Qty.	Order No.
WEW 35/2	100	1061200000
AEB 35 SC/1	50	1991920000
SDK PZ2 X 100	1	2749450000
SK WSD-S 1,5-10,0	1	9008850000





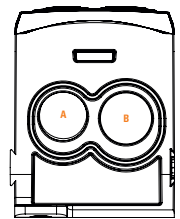



output





input









Conductor connection data according to IEC 60947-1 (Cu)





Input	connection point A		connection point B	
	Copper		Copper	
				
185 mm ²	25 Nm			
150 mm ²				
120 mm ²				
95 mm ²				
70 mm ²				
50 mm ²				25 Nm
Stripping lengths	33 mm		28 mm	
Allen screw	M16		M16	

Output	connection point 1-8	
	Copper	
		
35 mm ²	6 Nm	
25 mm ²		
16 mm ²		
10 mm ²		
6 mm ²		
4 mm ²		
2,5 mm ²		
Stripping lengths	16 mm	
Allen screw	M8	

 Mehrdrätig
 Eindrätig
 Feindrätig mit Aderendhülse

Conductor connection data according to UL 1059 (Al+Cu)

Input (line)	connection point A				connection point B			
	Copper		Aluminium		Copper		Aluminium	
								
350 kcmil	249.6 Lb In.							
300 kcmil								
250 kcmil								
AWG 4/0								
AWG 3/0								
AWG 2/0								
AWG 1/0								
max. current	310 A	285 A	250 A	230 A	285 A	255 A	230 A	205 A
Voltage size B,C (UR)	1000 V				1000 V			

Output	connection point 1 / 2 / 3 / 4 / 5 / 6 / 7 / 8			
	Copper		Aluminium	
				
AWG 2	124.8 Lb In.			
AWG 3				
AWG 4				
AWG 6				
AWG 8				
AWG 10				
AWG 12				
AWG 14				
max. current	115 A	100 A	90 A	75 A
Voltage size B,C (UR)	1000 V			

 Stranded
 Solid
 Flexible with ferrule



Socket wides - overview WPD

Application range

	WPD 104	WPD 105	WPD 106	WPD 107	WPD 108	WPD109
Inputs						
Main connection point ["A"]	SW 3 (M6x10)	SW 4 (M8x12)	SW 5 (M10x1x12)	SW 6 (M12x16)	SW 6 (M14x1.5x18)	SW 6 (M14x1.5x18)
Second connection point / cross connection ["B"]	Pozi 2 (M6x11)	Pozi 2 (M6x11)				
Connection input or output with 2 x 35mm ²				SW 4 (M8x12)		
Ribbon cable connection 15.5 x 5 mm			SW 4 (M5x20)			
Ribbon cable connection 24 x 10 mm					SW 5 (M6x30)	SW 5 (M6x30)
Outputs						
2 x 16 mm ²	SW 3 (M6x8)					
3 x 10 mm ²	SW 2.5 (M5x8)					
2 x 25 mm ²		SW 3 (M6x10)	SW 3 (M6x8)			
3 x 16 mm ²		SW 3 (M6x8)	SW 3 (M6x8)			
8 x 25 mm ²				SW 3 (M6x10)		
2 x 35 mm ²					SW 4 (M8x10)	SW 4 (M8x10)
3 x 25 mm ²					SW 3 (M6x8)	SW 3 (M6x8)
4 x 16 mm ²					SW 3 (M6x8)	SW 3 (M6x8)

	WPD 111	WPD 113
Inputs		
Main connection point ["A"]	SW 6 (M12)	M16
Second connection point / cross connection ["B"]		M16
Connection input or output with 2 x 35mm ²		
Ribbon cable connection 15.5 x 5 mm		
Outputs		
35 mm ³	SW 4 (M8)	M8
25 mm ²	SW 4 (M8)	M8
16 mm ²	SW 4 (M8)	M8
10 mm ²	SW 4 (M8)	M8
6 mm ²	SW 4 (M8)	M8
4 mm ²	SW 4 (M8)	M8
2,5 mm ²	SW 4 (M8)	M8

	WPD 130	WPD 230	WPD 330	WPD 131	WPD 231	WPD 132	WPD 232	WPD 133	WPD 233
Inputs									
1 x 50 mm ²	SW 5 (M10x1.25)								
2 x 50 mm ²		SW 5 (M10x1.25)							
3 x 50 mm ²			SW 5 (M10x1.25)						
1 x 95 mm ²				SW 6 (M14x1.5)					
2 x 95 mm ²					SW 6 (M14x1.5)				
1 x 185 mm ²						SW 10 (M18x2)			
2 x 185 mm ²							SW 10 (M18x2)		
1 x 300 mm ²								SW 12 (M24x2)	
2 x 300 mm ²									SW 12 (M24x2)
Outputs									
1 x 50 mm ²	SW 5 (M10x1.25)								
2 x 50 mm ²		SW 5 (M10x1.25)							
3 x 50 mm ²			SW 5 (M10x1.25)						
1 x 95 mm ²				SW 6 (M14x1.5)					
2 x 95 mm ²					SW 6 (M14x1.5)				
1 x 185 mm ²						SW 10 (M18x2)			
2 x 185 mm ²							SW 10 (M18x2)		
1 x 300 mm ²								SW 12 (M24x2)	
2 x 300 mm ²									SW 12 (M24x2)

B



	WPD 101	WPD 301	WPD 401	WPD 501	WPD 102	WPD 202	WPD 302	WPD 103
Inputs								
1 x 16 mm ²	cross recess+/- G2 (M6)							
1 x 25 mm ²	cross recess+/- G2 (M6)				cross recess+/- G2 (M6)			
2 x 25 mm ²						cross recess+/- G2 (M6)		
3 x 16 mm ²		cross recess+/- G2 (M6)						
3 x 25 mm ²		cross recess+/- G2 (M6)					cross recess+/- G2 (M6)	
4 x 16 mm ²			cross recess+/- G2 (M6)					
4 x 25 mm ²			cross recess+/- G2 (M6)					
5 x 16 mm ²				cross recess+/- G2 (M6)				
5 x 25 mm ²				cross recess+/- G2 (M6)				
1 x 35 mm ²					cross recess+/- G2 (M8)			
2 x 35 mm ²						cross recess+/- G2 (M8)		
3 x 35 mm ²							cross recess+/- G2 (M8)	
1 x 50 mm ²								hexagonal recess SW4 (M8)
1 x 70 mm ²								hexagonal recess SW4 (M10)
Outputs								
1 x 16 mm ²	cross recess+/- G2 (M6)							
1 x 25 mm ²	cross recess+/- G2 (M6)				cross recess+/- G2 (M6)			
2 x 25 mm ²						cross recess+/- G2 (M6)		
3 x 16 mm ²		cross recess+/- G2 (M6)						
3 x 25 mm ²		cross recess+/- G2 (M6)					cross recess+/- G2 (M6)	
4 x 16 mm ²			cross recess+/- G2 (M6)					
4 x 25 mm ²			cross recess+/- G2 (M6)					
5 x 16 mm ²				cross recess+/- G2 (M6)				
5 x 25 mm ²				cross recess+/- G2 (M6)				
1 x 35 mm ²					cross recess+/- G2 (M8)			
2 x 35 mm ²						cross recess+/- G2 (M8)		
3 x 35 mm ²							cross recess+/- G2 (M8)	
1 x 50 mm ²								hexagonal recess SW4 (M8)
1 x 70 mm ²								hexagonal recess SW4 (M10)



Conductor connection data WPD

Type	Input side											
	input cross section	Copper					Aluminium					
		solid	stranded	Finely stranded with wire end ferrule	flat band	Tightening Torque	solid	stranded	flexible with ferrule	sector shape	Tightening Torque	
WPD 130/230/330		35-50 mm ²	3-50 mm ²	35 mm ²		10 Nm	35-50 mm ²	35-50 mm ²		35-50 mm ²	14 Nm	
		16-25 mm ²	16-25 mm ²	16-25 mm ²		8 Nm	25 mm ²	25 mm ²			12 Nm	
		6-10 mm ²	6-10 mm ²	4-10 mm ²		6 Nm	16mm ²	16 mm ²		16 - 25 mm ²	10 Nm	
WPD 131/231		35-95 mm ²	35-95 mm ²	35-70 mm ²		19 Nm	16-95 mm ²	16-95 mm ²		16-95 mm ²	22.6 Nm	
		10-25 mm ²	10-25 mm ²	10-25 mm ²		14 Nm						
WPD 132/232					10 x 15.5 x 8 mm	30.9 Nm	95-185 mm ²	95-185 mm ²		95-185 mm ²	30.9 Nm	
		95-185 mm ²	95-185 mm ²	95-150 mm ²		25 Nm						
				25-70 mm ²		20 Nm						
WPD 133/233					10 x 20 x 1mm	65 Nm	150-300 mm ²	150-300 mm ²		150-300 mm ²	65 Nm	
		150-300 mm ²	150-300 mm ²	150-240 mm ²		45 Nm						
				35-95 mm ²		30 Nm						
WPD x01	2 x 25 mm ²	2.5-25 mm ²	2.5-25 mm ²	1.5-16 mm ²		3.5 Nm	16-25 mm ²	16-25 mm ²			4 Nm	
	2 x 16 mm ²	1.5-16 mm ²	1.5-16 mm ²	1.5-10 mm ²		2.5 Nm	25 mm ²	25 mm ²			4 Nm	
WPD x02		4-35 mm ²	4-35 mm ²	2.5-25 mm ²		3.5 Nm	35 mm ²	35 mm ²			8 Nm	
	2 x 35 mm ²						25 mm ²	25 mm ²			6 Nm	
							16 mm ²	16 mm ²			4 Nm	
	2 x 25 mm ²	2.5-25 mm ²	2.5-25 mm ²	2.5-16 mm ²		3.5 Nm	25 mm ²	25 mm ²			6 Nm	
WPD x03							16 mm ²	16 mm ²			4 Nm	
	2 x 70 mm ²	10-70 mm ²	10-70 mm ²	6-50 mm ²		10 Nm	17mm ²	17mm ²			18 Nm	
								50 mm ²	50 mm ²			10 Nm
								35 mm ²	35 mm ²			8 Nm
								25 mm ²	25 mm ²			6 Nm
	2 x 50 mm ²							16 mm ²	16 mm ²			4 Nm
		6-50 mm ²	6-50 mm ²	4-35 mm ²		6 Nm	50 mm ²	50 mm ²			10 Nm	
								35 mm ²	35 mm ²			8 Nm
							25 mm ²	25 mm ²			6 Nm	
WPD x04	1 x 25 mm ²	2.5-25 mm ²	2.5-25 mm ²	1.5-16 mm ²		2.5 Nm	16-25 mm ²	16-25 mm ²	16mm ²	16-25 mm ²	5.1 Nm	
	1 x 16 mm ²	1.5-16 mm ²	1.5-16 mm ²	1.5-10 mm ²		2.5 Nm	10 mm ²	10 mm ²		10 mm ²	5.1 Nm	
WPD x05	1x 35 mm ²	4-35 mm ²	4-35 mm ²	2.5-25 mm ²		3.5 Nm	25-35 mm ²	25-35 mm ²	25mm ²	25-35 mm ²	11.3 Nm	
	1 x 16 mm ²	1.5-16 mm ²	1.5-16 mm ²	1.5-10 mm ²		2.5 Nm	10 mm ²	10 mm ²		10 mm ²	5.1 Nm	
WPD x06	1 x 70 mm ²	10-70 mm ²	10-70 mm ²	6-50 mm ²		10 Nm	10-70 mm ²	10-70 mm ²	10-50 mm ²	10-70 mm ²	13.6 Nm	
	15.5 x 5 mm				15.5 x 5 mm	2 Nm						
WPD x07	1 x 95 mm ²	16-95 mm ²	16-95 mm ²	10-70 mm ²		14 Nm	16-95 mm ²	16-95 mm ²	16-70 mm ²	16-95 mm ²	22.6 Nm	
	2 x 35 mm ²	4-35 mm ²	4-35 mm ²	2.5-25 mm ²		3.5 Nm	16-35 mm ²	16-35 mm ²	16-25 mm ²	16-35 mm ²	11.3 Nm	
WPD x08	1 x 120 mm ²	35-120 mm ²	35-120 mm ²	25-95 mm ²		19Nm	35-120 mm ²	35-120 mm ²	35-95 mm ²	35-120 mm ²	22.6 Nm	
	24 x 10 mm				24 x 10 mm	3 Nm						
WPD x09	1x 185 mm ²	70-185 mm ²	70-185 mm ²	50-150 mm ²		19 Nm	70-185 mm ²	70-185 mm ²	70-150 mm ²	70-185 mm ²	22.6 Nm	
	24 x 10 mm				24 x 10 mm	3 Nm						
WPD 111	1 x 95 mm ²	16-95 mm ²	16-95 mm ²	10-70 mm ²		14 Nm						
WPD 113	1 x 185 mm ²	95-185 mm ²	95-185 mm ²	70-150 mm ²		25 Nm						
	1 x 150 mm ²	70-150 mm ²	70-150 mm ²	50-120 mm ²		25 Nm						



Output side										Auxiliary connection			
output cross section	Copper				Aluminium					solid	stranded	Finely stranded with wire end ferrule	Tightening Torque
	solid	stranded	Finely stranded with wire end ferrule	Tightening Torque	solid	stranded	Finely stranded with wire end ferrule	sector shape	Tightening Torque				
	35-50 mm ²	35-50 mm ²	35 mm ²	10 Nm	35-50 mm ²	35-50 mm ²		35-50 mm ²	14 Nm				
	16 - 25 mm ²	16 - 25 mm ²	16 - 25 mm ²	8 Nm	25 mm ²	25 mm ²			12 Nm				
	6 - 10 mm ²	6 - 10 mm ²	4 - 10 mm ²	6 Nm	16mm ²	16 mm ²		16 - 25 mm ²	10 Nm				
	35-95 mm ²	35-95 mm ²	35-70 mm ²	19 Nm	16-95 mm ²	16-95 mm ²		16-95 mm ²	22.6 Nm	1.5-10 mm ²	1.5-10 mm ²	1.5-6 mm ²	1.2 Nm
	10-25 mm ²	10-25 mm ²	10-25 mm ²	14 Nm									
	95-185 mm ²	95-185 mm ²	95-150 mm ²	25 Nm	95-185 mm ²	95-185 mm ²		95-185 mm ²	30.9 Nm	1.5-10 mm ²	1.5-10 mm ²	1.5-6 mm ²	1.2 Nm
			25-70 mm ²	20 Nm									
	150-300 mm ²	150-300 mm ²	150-240 mm ²	45 Nm	150-300 mm ²	150-300 mm ²		150-300 mm ²	65 Nm	1.5-10 mm ²	1.5-10 mm ²	1.5-6 mm ²	1.2 Nm
			35-95 mm ²	30 Nm									
2 x 25 mm ²	2.5-25 mm ²	2.5-25 mm ²	1.5-16 mm ²	3.5 Nm	16-25 mm ²	16-25 mm ²			4 Nm				
2 x 16 mm ²	1.5-16 mm ²	1.5-16 mm ²	1.5-10 mm ²	2.5 Nm	2.5 Nm	25 mm ²			4 Nm				
2 x 35 mm ²	4-35 mm ²	4-35 mm ²	2.5-25 mm ²	3.5 Nm	35 mm ²	35 mm ²			8 Nm				
					25 mm ²	25 mm ²			6 Nm				
					16 mm ²	16 mm ²			4 Nm				
2 x 25 mm ²	2.5-25 mm ²	2.5-25 mm ²	2.5-16 mm ²	3.5 Nm	25 mm ²	25 mm ²			6 Nm				
					16 mm ²	16 mm ²			4 Nm				
2 x 70 mm ²	10-70 mm ²	10-70 mm ²	6-50 mm ²	10 Nm	17mm ²	17mm ²			18 Nm				
					50 mm ²	50 mm ²			10 Nm				
					35 mm ²	35 mm ²			8 Nm				
					25 mm ²	25 mm ²			6 Nm				
					16 mm ²	16 mm ²			4 Nm				
2 x 50 mm ²	6-50 mm ²	6-50 mm ²	4-35 mm ²	6 Nm	50 mm ²	50 mm ²			10 Nm				
					35 mm ²	35 mm ²			8 Nm				
					25 mm ²	25 mm ²			6 Nm				
					16 mm ²	16 mm ²			4 Nm				
2 x 16 mm ²	1.5-16 mm ²	1.5-16 mm ²	1.5-10 mm ²	2.5 Nm	10-16 mm ²	10-16 mm ²	10 mm ²	10-16 mm ²	5.1 Nm				
3 x 10 mm ²	1.5-10 mm ²	1.5-10 mm ²	1.5-16 mm ²	2 Nm	10 mm ²	10 mm ²		10 mm ²	5.1 Nm				
2 x 25 mm ²	2.5-25 mm ²	2.5-25 mm ²	1.5-16 mm ²	2.5 Nm	10-16 mm ²	10-16 mm ²	10 mm ²	10-16 mm ²	5.1 Nm				
3 x 16 mm ²	1.5-16 mm ²	1.5-16 mm ²	1.5-10 mm ²	2 Nm	10 mm ²	10 mm ²		10 mm ²	5.1 Nm				
2 x 25 mm ²	2.5-25 mm ²	2.5-25 mm ²	1.5-16 mm ²	2.5 Nm	10-16 mm ²	10-16 mm ²	10 mm ²	10-16 mm ²	5.1 Nm				
3 x 16 mm ²	1.5-16 mm ²	1.5-16 mm ²	1.5-10 mm ²	2 Nm	10 mm ²	10 mm ²		10 mm ²	5.1 Nm				
8 x 25 mm ²	2.5-25 mm ²	2.5-25 mm ²	1.5-16 mm ²	2.5 Nm	16-25 mm ²	16-25 mm ²	16 mm ²	16-25 mm ²	5.1 Nm				
2 x 35 mm ²	4-35 mm ²	4-35 mm ²	2.5-25 mm ²	2.5 Nm	16-35 mm ²	16-35 mm ²	16-25 mm ²	16-35 mm ²	11.3 Nm				
4 x 16 mm ²	1.5-16 mm ²	1.5-16 mm ²	1.5-10 mm ²	2 Nm	1.5-16 mm ²	1.5-16 mm ²	1.5-10 mm ²	1.5-16 mm ²	5.1 Nm				
3 x 25 mm ²	2.5-25 mm ²	2.5-25 mm ²	1.5-16 mm ²	2 Nm	2.5-25 mm ²	2.5-25 mm ²	1.5-16 mm ²	2.5-25 mm ²	5.1 Nm				
2 x 35 mm ²	4-35 mm ²	4-35 mm ²	2.5-25 mm ²	2.5 Nm	16-35 mm ²	16-35 mm ²	16-25 mm ²	16-35 mm ²	11.3 Nm				
4 x 16 mm ²	1.5-16 mm ²	1.5-16 mm ²	1.5-10 mm ²	2 Nm	16 mm ²	16 mm ²		16 mm ²	5.1 Nm				
3 x 25 mm ²	2.5-25 mm ²	2.5-25 mm ²	1.5-16 mm ²	2 Nm	16-25 mm ²	16-25 mm ²	16 mm ²	16-25 mm ²	5.1 Nm				
4 x 35 mm ²	4-35 mm ²	4-35 mm ²	2.5-25 mm ²	6 Nm					4 Nm				
8 x 35 mm ²	4-35 mm ²	4-35 mm ²	2.5-25 mm ²	6 Nm									



Mounting

Application range

WPD 104

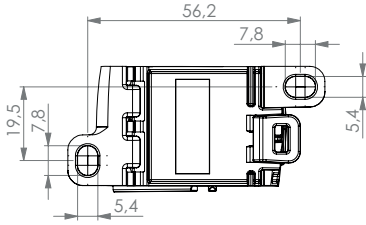

WPD 109

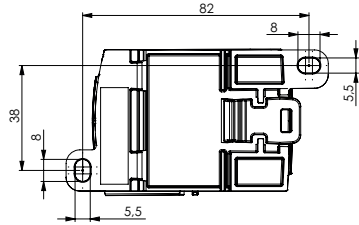

WPD 330

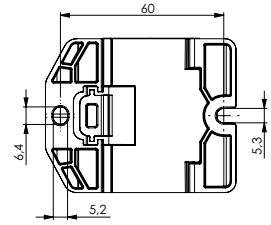

WPD 105

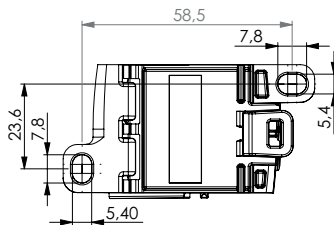

WPD 111

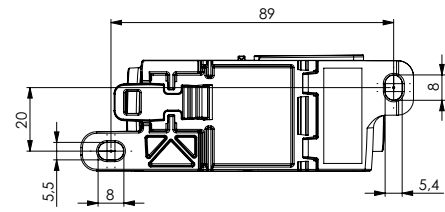

WPD 330CC

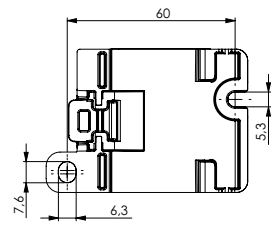

B

WPD 106

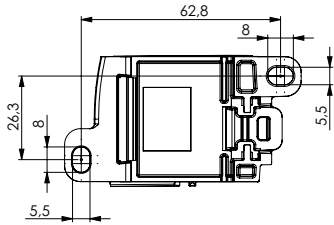

WPD 113

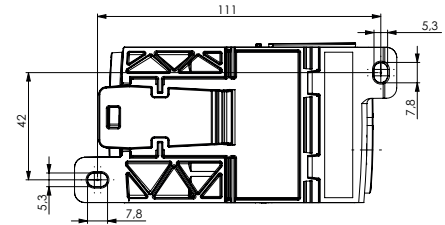

WPD 131

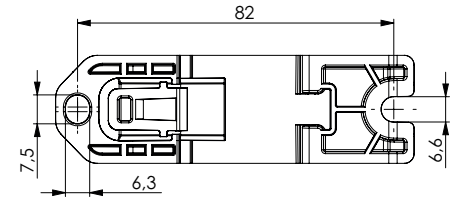

WPD 107

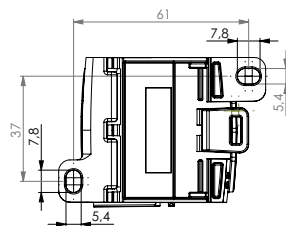

WPD 130

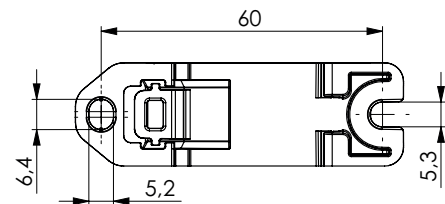

WPD 231

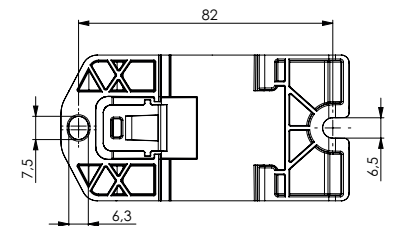

WPD 108

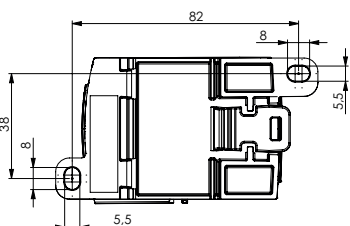

WPD 230

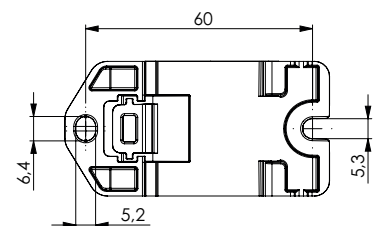

WPD 331CC

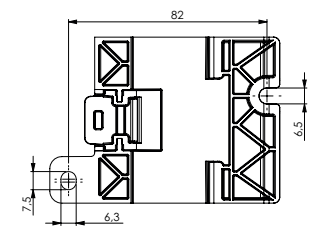

WPD 132

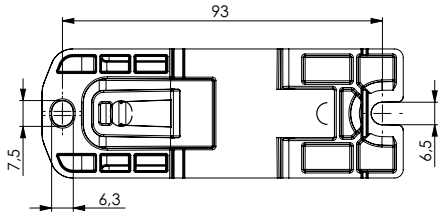

WPD 232

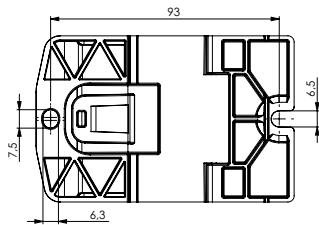

WPD 133

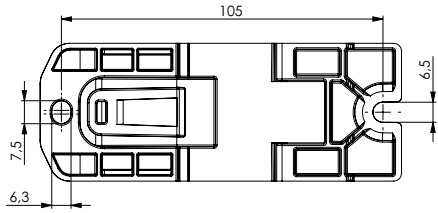

WPD 233

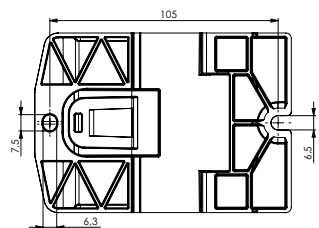



Width/Height/Depth	mm
max. current / max. cond. cross-section	A/mm ²
Max. clamping range	mm ²

Technical data

Rated data	
Rated voltage	V
Rated current	A
for wire cross-section	mm ²
Rated impulse withstand voltage / Pollution severity	
Gauge to IEC 60947-1 / UL 94 flammability rating	
Approvals	
Clamped conductors (H05V/H07V)	
Solid / Stranded	mm ²
Flexible / Flexible with ferrule	mm ²
Stripping length / Blade size	mm/-

Note

Ordering data

Version	dark beige
Note	

Accessories

Plug-in cross-connection	
	2-pole
	10-pole
Vertical jumpers	
	1-pole
End plate	dark beige
End bracket	dark beige, screwable dark beige, direct mounting
Test plug	
Screwdriver	Standard
Marking tags	

For detailed information on other accessories and application in the online catalogue

AMC 2.5

2.5 mm²



5.1 x 107.5 x 88
22 / 2.5
0.14...2.5

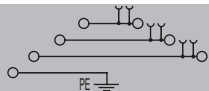

DIN EN 60947-7-1, DIN EN 60947-7-2 Ex eb II C Gb II 2 G D

IEC	UL	CSA	EN 60079-7
690	150	150	440
22	20	20	19
2.5	AWG 28...12	AWG 28...12	2.5 mm ²

8 kV / 3

A3 / V-0

TUEV16ATEX7909U

Rated connection	
0.5...2.5 / 0.5...4	
0.5...4 / 0.5...2.5	
10 / 0.6 x 3.5 mm	

Type	Qty.	Order No.
AMC 2.5	50	2434340000

Type	Qty.	Order No.
ZQV 2.5N/2	24 A 60	1527540000
ZQV 2.5N/10	24 A 20	1527690000
ZVQ 2.5/1.5	24 A 50	1720700000
AEP MC 2.5	25	2433820000
AEB 35 SC/1	50	1991920000
AEB 35 SCL/1 VO	20	2661280000
PS 2.0 MC	20	0310000000
SDIL 0,6X3,5X100	1	2749140000
DEK 5/5 PLUS MC NE WS	1000	1854490000
DEK 5/5 MM WS	800	2007110000
WS 8/5 MM WS	800	2007150000
WS 10/5 M PLUS MC NE WS	600	2003770000
SNAPMARK I	50	1805880000

AMC 2.5 800 V

2.5 mm²



6.1 x 107.5 x 88
22 / 2.5
0.14...2.5

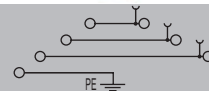

DIN EN 60947-7-1, DIN EN 60947-7-2 Ex eb II C Gb II 2 G D

IEC	UL	CSA	EN 60079-7
800	600	600	440
22	20	20	19
2.5	AWG 28...12	AWG 28...12	2.5 mm ²

8 kV / 3

A3 / V-0

TUEV16ATEX7909U

Rated connection	
0.5...2.5 / 0.5...4	
0.5...4 / 0.5...2.5	
10 / 0.6 x 3.5 mm	

Type	Qty.	Order No.
AMC 2.5 800V	50	2434370000

Type	Qty.	Order No.
ZVQ 2.5/1.5	24 A 50	1720700000
AEB 35 SC/1	50	1991920000
AEB 35 SCL/1 VO	20	2661280000
PS 2.0 MC	20	0310000000
SDIL 0,6X3,5X100	1	2749140000
DEK 5/5 PLUS MC NE WS	1000	1854490000
DEK 5/5 MM WS	800	2007110000
WS 8/5 MM WS	800	2007150000
WS 10/5 M PLUS MC NE WS	600	2003770000
SNAPMARK I	50	1805880000



ZMAK 2.5

2.5 mm²

Motor-supply terminal

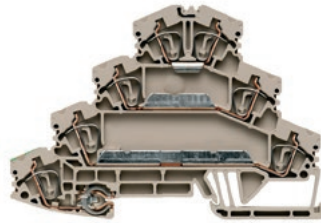

5.1 x 102 x 69.5
31 / 4
0.13...4

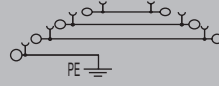

IEC 60947-7-1 (-7-2)

IEC	UL	CSA	EN 60079-7
400	300	300	
24	25	25	
2.5	AWG 26...12	AWG 26...12	
6 kV / 3			
A3 / V-0			

CE

Rated connection
0.5...4
0.5...4 / 0.5...2.5
10 / 0.6 x 3.5 mm

ZMAK 2.5 690 V

2.5 mm²

Motor-supply terminal



6.1 x 102 x 69.5
31 / 4
0.13...4

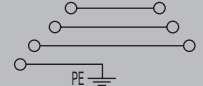

IEC 60947-7-1 (-7-2)

IEC	UL	CSA	EN 60079-7
690	300		
24	25		
2.5	AWG 26...12		
6 kV / 3			
A3 / V-0			

CE

Rated connection
0.5...4
0.5...4 / 0.5...2.5
10 / 0.6 x 3.5 mm

Width/Height/Depth	mm
max. current / max. cond. cross-section	A/mm ²
Max. clamping range	mm ²

Technical data

Rated data	
Rated voltage	V
Rated current	A
for wire cross-section	mm ²
Rated impulse withstand voltage / Pollution severity	
Gauge to IEC 60947-1 / UL 94 flammability rating	
Approvals	
Clamped conductors (H05V/H07V)	
Solid / Stranded	mm ²
Flexible / Flexible with ferrule	mm ²
Stripping length / Blade size	mm/-

Note

Ordering data

Version	
	dark beige
Note	

Accessories

End plate / Partition plate	dark beige
End bracket	dark beige
Screwdriver	Standard
Reducing sleeves	for conductors < 0.5 mm ² / AWG 20 for conductors < 1.0 mm ² / AWG 18
Test adapter	Standard
Marking tags	

Type	Qty.	Order No.
ZMAK 2.5	25	1768000000

Type	Qty.	Order No.
ZAP ZMAK2.5	10	1768010000
ZEW 35	20	9540000000
SDIS SLIM 0.6X3.5X100	1	2749610000
ZRH 1.5H/1	1000	1678810000
ZRH 1.5H/2	1000	1678800000
ZTA 1	9 A 25	1609040000
DEK 5/5 MC NE WS	1000	1609801044
WS 12/5 MC NE WS	720	1609860000
DEK 5/5 MM WS	800	2007110000
WS 8/5 MM WS	800	2007150000

Type	Qty.	Order No.
ZMAK 2.5 690V	25	1027550000

The ZMAK 2.5 690 V with pre-assembled end plate and a width of 6.1 mm.

Type	Qty.	Order No.
ZAP ZMAK2.5	10	1768010000
ZEW 35	20	9540000000
SDIS SLIM 0.6X3.5X100	1	2749610000
ZRH 1.5H/1	1000	1678810000
ZRH 1.5H/2	1000	1678800000
DEK 5/5 MC NE WS	1000	1609801044
WS 12/5 MC NE WS	720	1609860000

For detailed information on other accessories and application in the online catalogue



Power distribution
Screw connection



WDK 10 SET LS

10 mm²

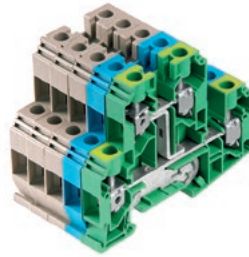

49.5 x 85 x 69	
70 / 16	
1.5...16	

WDK 10 SET BCD

10 mm²

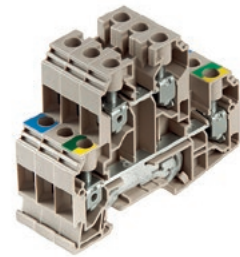

29.7 x 85 x 69	
70 / 16	
1.5...16	

Width/Height/Depth	mm
max. current / max. cond. cross-section	A/mm ²
Max. clamping range	mm ²

Width/Height/Depth	mm
max. current / max. cond. cross-section	A/mm ²
Max. clamping range	mm ²

Technical data

Rated data	
Rated voltage	V
Rated current	A
for wire cross-section	mm ²
Rated impulse withstand voltage / Pollution severity	
Gauge to IEC 60947-1 / UL 94 flammability rating	
Approvals	
Clamped conductors (H05V/H07V)	
Solid / Stranded	mm ²
Flexible / Flexible with ferrule	mm ²
Tightening torque / Clamping screw	Nm
Stripping length / Blade size	mm/-
2 conductors with same cross-section (H05V/H07V)	
Solid / Stranded	-
Flexible / Flexible with ferrule	-
Note	

IEC 60947-7-1 (-7-2)			
IEC	UL	CSA	EN 60079-7
800	600	600	
57	64	64	
10	AWG 18...6	AWG 18...6	
8 kV / 3			
B6 / V-0			
CE CB IEC VDE			
Rated connection		Further connection	
1.5...16 / 1.5...16			
1.5...16 / 1.5...16			
1.2...1.9 / (M 4)			
12 / 1.0 x 5.5 mm			
Note			

IEC 60947-7-1 (-7-2)			
IEC	UL	CSA	EN 60079-7
800	600	600	
57	64	64	
10	AWG 18...6	AWG 18...6	
8 kV / 3			
B6 / V-0			
CE CB IEC VDE			
Rated connection		Further connection	
1.5...16 / 1.5...16			
1.5...16 / 1.5...16			
1.2...1.9 / (M 4)			
12 / 1.0 x 5.5 mm			
Note			

Ordering data

Version	dark beige with PE foot dark beige / green / yellow
Note	

Type	Qty.	Order No.
WDK 10 SET LS	1	1415530000
Note		

Type	Qty.	Order No.
WDK 10 SET BCD	1	1415540000
Note		

Accessories

Screwable cross-connection	
	2-pole
	10-pole
End plate / Partition plate	
	dark beige
	Blue
End bracket	
	dark beige
	dark beige, screwable
Screwdriver	
	Standard
Cover	
	Blank, white
	Blank, yellow
Marking tags	
Cross-connector	
	black
	blue
	red

Type	Qty.	Order No.
WQV 10/2	76 A 50	1052560000
WQV 10/10	63 A 20	1052460000
End plate / Partition plate		
WAP WDK10	20	1186720000
WAP WDK10 BL	20	1186730000
End bracket		
WEW 35/2	50	1061200000
Screwdriver		
SDS 1.0X5.5X150	1	2749380000
Cover		
WAD 8 MC NE WS	48	1112940000
WAD 8 MC NE GE	48	1112950000
Marking tags		
DEK 5/5 MC NE WS	1000	1609801044
Cross-connector		

Type	Qty.	Order No.
WQV 10/2	76 A 50	1052560000
WQV 10/10	63 A 20	1052460000
End plate / Partition plate		
WAP WDK10	20	1186720000
WAP WDK10 BL	20	1186730000
End bracket		
WEW 35/2	50	1061200000
Screwdriver		
SDS 1.0X5.5X150	1	2749380000
Cover		
WAD 8 MC NE WS	48	1112940000
WAD 8 MC NE GE	48	1112950000
Marking tags		
DEK 5/5 MC NE WS	1000	1609801044
Cross-connector		

For detailed information on other accessories and application in the online catalogue

MAK 2.5

2.5 mm²

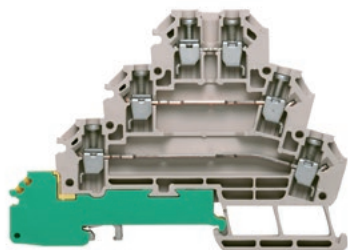

6.2 x 88 x 63
31 / 4
0.13...4

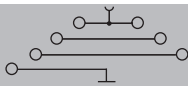

IEC 60947-7-1 (-7-2)

IEC	UL	CSA	EN 60079-7
500	300	300	
24	10	10	
2.5	AWG 26...12	AWG 26...12	
6 kV / 3			
A3 / V-0			

CE ENEC 79

Rated connection	Further connection
0.5...4 / 0.5...4	
0.5...4 / 0.5...2.5	
0.4...0.6 / (M 2.5)	
8 / 0.6 x 3.5 mm	
0.5...1 / 0.5...1	
0.5...1 / 0.5...0.75	

Type	Qty.	Order No.
MAK 2.5 DB	50	7917030000

Type	Qty.	Order No.	
AP MAK 2.5 DB	20	7917000000	
WEW 35/1	50	1059000000	
SDIS 0.6X3.5X100	1	2749810000	
DEK 5/5 MC NE WS	1000	1609801044	
VQB 1.5/50 SW	17.5 A	5	1635120000
VQB 1.5/50 BL	17.5 A	5	1633280000
VQB 1.5/50 RT	17.5 A	5	1633290000

VLI 1.5

1.5 mm²

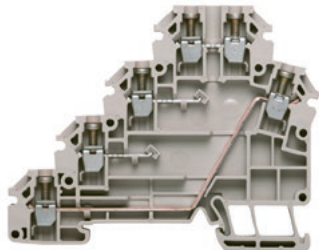

6.15 x 79.5 x 63
24 / 4
0.13...4

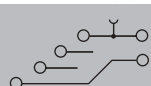

IEC 60947-7-1

IEC	UL	CSA	EN 60079-7
250	300		
17.5	10		
1.5	AWG 26...12		
4 kV / 3			
A3 / V-0			

CE 79

Rated connection	Further connection
0.5...4 / 0.5...2.5	
0.5...4 / 0.5...2.5	
0.4...0.6 / (M 2.5)	
8 / 0.6 x 3.5 mm	

Type	Qty.	Order No.
VLI 1.5 DB	50	1784120000
VLI 1.5/PE DB	50	1784130000

Type	Qty.	Order No.	
AP VLI 1.5 DB	20	1784150000	
WEW 35/1	50	1059000000	
SDIS 0.6X3.5X100	1	2749810000	
DEK 5/5 MC NE WS	1000	1609801044	
VQB 1.5/50 SW	17.5 A	5	1635120000
VQB 1.5/50 BL	17.5 A	5	1633280000
VQB 1.5/50 RT	17.5 A	5	1633290000

B



Safe supply to equipment in the panel

Klippon® Connect for optimum control voltage distribution

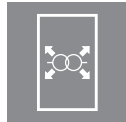

For power supplies to equipment in the panel, there is an increased risk of incorrect connections because of the large number of conductors. Our tailored AAP potential distribution terminal blocks and the maxGUARD modular system with built-in electronic load monitoring offer ideal solutions for surge current protection and clear, structured power distribution within control voltage circuits. The considerable space saving and reduced wiring means you can guarantee supply to your panel equipment simply and effectively.

Our promise

For complex wiring projects in confined spaces, we offer a future-oriented strategy for central potential distribution with direct wiring option for all the device's plus and minus potentials. This means that Klippon® Connect makes planning and implementing your control voltage distribution system considerably more productive.



Space saving

- Up to 50 percent more compact control voltage distribution thanks to the optional six conductor connections per terminal block
- Combined solution for fewer components and more available space on the terminal rail
- One solution to connect all the plus and minus connectors for the loads

Time saving

- Maximum time saving on wiring thanks to PUSH IN technology
- Consistent cross-connection systems
- Tailored assembly and ordering using the Weidmüller Configurator

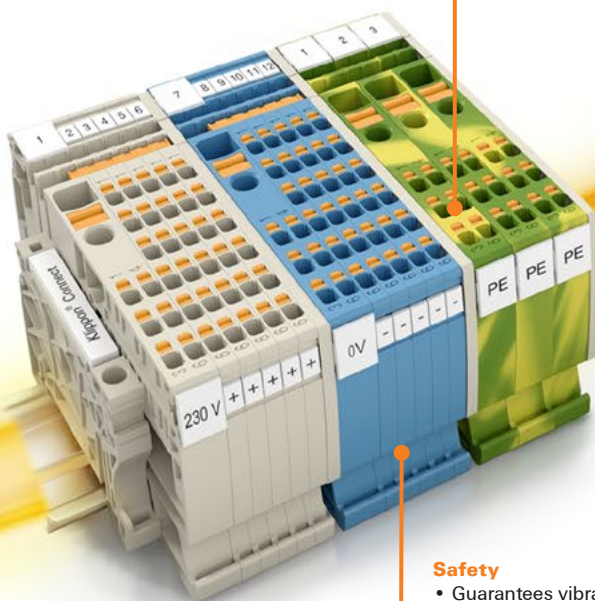
**Safety**

- Guarantees vibration-resistant and gas-tight connections
- Pusher and clear design to prevent mis-connection

**Flexibility**

- Simple to modify and expand
- Easy to rewire without special tools thanks to PUSH IN technology
- Universal use – for direct and alternating current from 0 to 250 V

Our range**Combined load monitoring and potential distribution:**

maxGUARD is our unique modular system for control voltage distribution. The consistent design of the electronic load monitoring and potential distribution terminal blocks plus the simple cross-connection options save time and money and prevent mis-connections.

**Simpler customised solutions:**

Our assembly service for standard blocks and completed control voltage distribution systems guarantees ease of ordering and production optimisation. We create a perfect-fit solution for all of your requirements.

Individual configuration for each control cabinet type

The modular terminal block system for control voltage distribution

Professional marking

Large marking areas in combination with our marking solutions ensure precise identification of the individual terminal blocks.

Convenient feed-in terminal block

A distinguishable power terminal offers a simple powersupply into the system.

Integrated test point

The integrated test and inspection tap enables quick and easy testing with standard size 2.0 probes and test plugs.

Double connection on power feed in terminal block

Additional connections on the feed in terminal block save components and assembly time. Depending on the system structure, additional space savings of 3.5 or 5.1 mm can be achieved.

Coloured pushers

The colour coding can easily distinguish the different potentials. Oversight saves time and costs for maintenance and troubleshooting.

Distinct contact identification

Each contact point on the terminal block has a distinct mark such that it can be assigned unambiguously to the connection point in the circuit diagram.

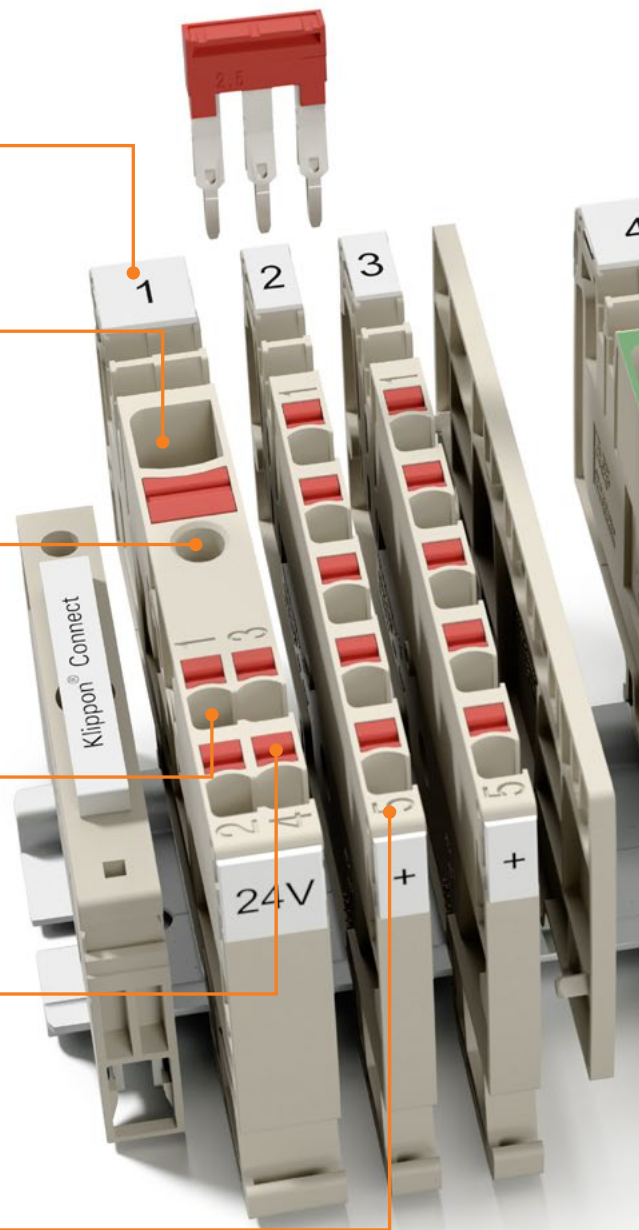

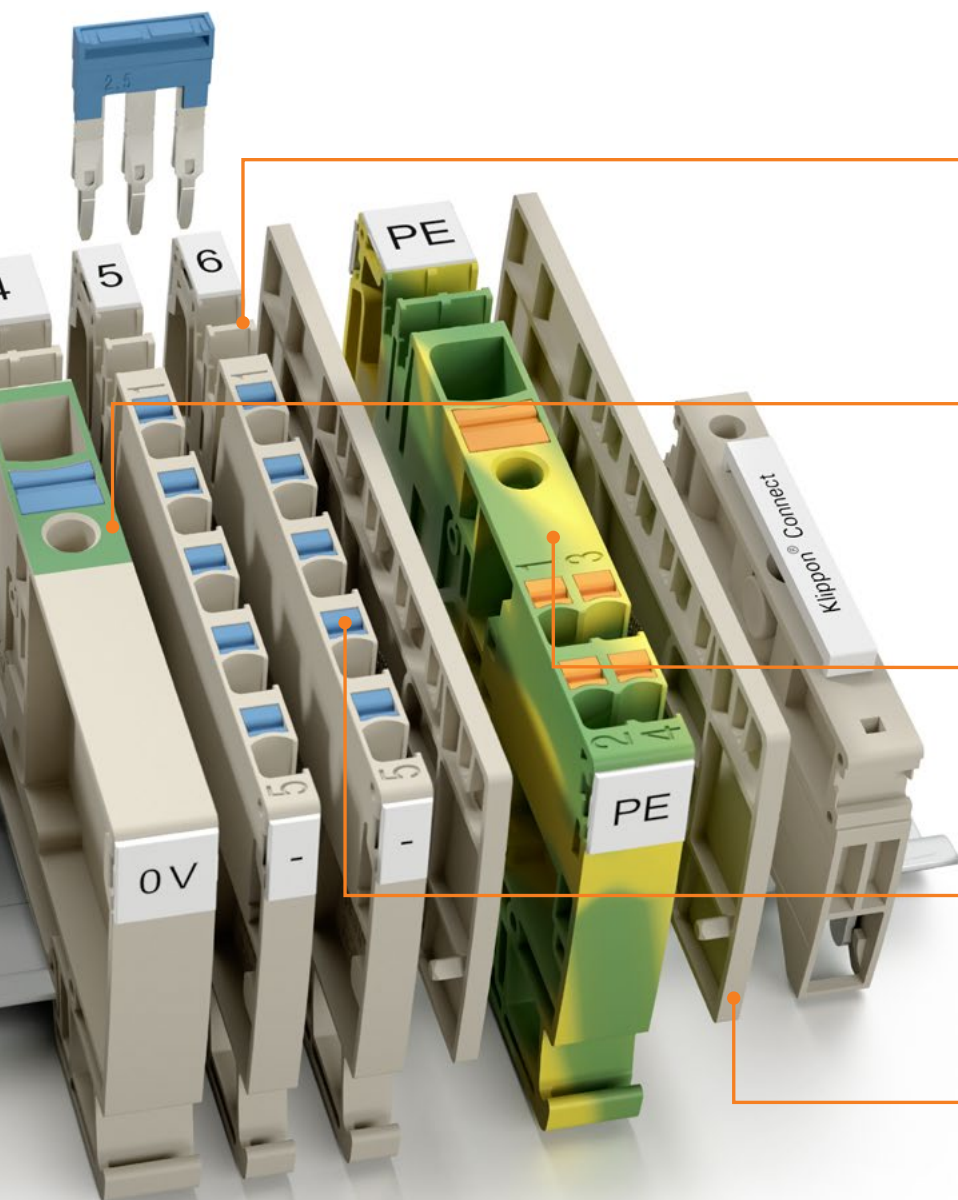

Two cross-connection channels

The modular system allows an additional terminal block to be attached and expanded via an additional cross-connection in the second cross-connection channel.

Optional FE variants

The FE terminals have a contact to the DIN rail underneath, which serves as zero adjustment of the potentials.

PE - Protective earth terminal block

Terminal blocks for connecting protective earth conductors completes the AAP system (plus, minus and PE). The power terminals with protective conductor functions comply with the IEC 60947-7-2 standard.

Clear distribution terminal block

Easily identifiable terminals to distribute power to individual branch circuits.

Robust end plates

The end plates ensure finger safety and separation of the different potentials.

B



Control voltage distribution
PUSH IN connection

AAP - potential distribution terminal blocks

Potential distribution with separate fusing



Width/Height/Depth	mm
max. current / max. cond. cross-section	A/mm ²
Max. clamping range	mm ²

Technical data

Rated data	
Rated voltage of feed-through terminal	V
Rated current	A
for wire cross-section	mm ²
Rated impulse withstand voltage / Pollution severity	
Gauge to IEC 60947-1 / UL 94 flammability rating	
Approvals	
Clamped conductors (H05V/H07V)	
Solid / Stranded	mm ²
Flexible / Flexible with ferrule	mm ²
Stripping length / Blade size	mm/-
Note	

Ordering data

Version	
	beige / red pusher
	beige / blue pusher
	beige / orange pusher
	beige / white pusher
	green-yellow / orange pusher
	blue / orange pusher
	green / orange pusher
Note	

Accessories

Plug-in cross-connection	
	2-pole/ red
	10-pole/ red
	2-pole/ blue
	10-pole/ blue
End plate / Partition plate	
End bracket	
	dark beige, screwable
	dark beige, direct mounting
Test adapter	
	1-pole
Test plug	
Screwdriver	
	Standard
Marking tags	

For detailed information on other accessories and application in the online catalogue

AAP11 6 LO

6 mm²

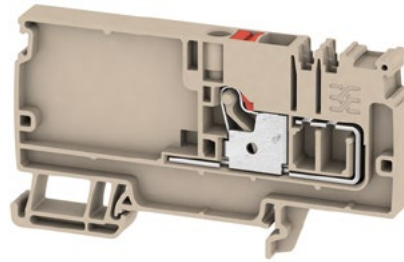

8.1 x 85.5 x 47
41 / 6
0.34...6

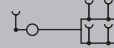

In accordance with IEC 60947-7-1

IEC	UL	CSA	EN 60079-7
500	300	300	
41	36	36	
6	AWG 22...8	AWG 22...8	
6 kV / 3			
A5 / V-0			
Rated connection			
0.5...6 / 0.5...6			
0.5...6 / 0.5...6			
12 / 1.0 x 5.5 mm			
Note			

Type	Qty.	Order No.
AAP11 6 LO RD	20	1989780000
AAP11 6 LO BL	20	1988130000
AAP11 6 LO OR	20	2503650000
AAP11 6 LO WT	20	2683430000
AAP11 6 LO BL/OR	20	2522720000
AAP11 6 LO GN/OR	20	2718300000
Note		

Type	Qty.	Order No.
ZQV 1.5N/2 RD	17.5 A 60	1985650000
ZQV 1.5N/10 RD	17.5 A 20	1985800000
ZQV 1.5N/2 BL	17.5 A 60	1985530000
ZQV 1.5N/10 BL	17.5 A 20	1985680000
AEP AP11	20	1988320000
AEB 35 SC/1	50	1991920000
AEB 35 SCL/1 VO	20	2661280000
ATPG 1.5-10 L	0.2 A 50	1991890000
PS 2.0 MC	20	0310000000
SDIL 1,0X5,5X125	1	2749160000
DEK-A 5/8 MM WS	500	2448860000
WS-A 8/8 MM WS	500	2448930000
DEK 5/8 PLUS MC NE WS	800	1046350000
WS 10/8 PLUS MC NE WS	420	1905950000
Note		

For detailed information on other accessories and application in the online catalogue

AAP11 6 FE

6 mm²

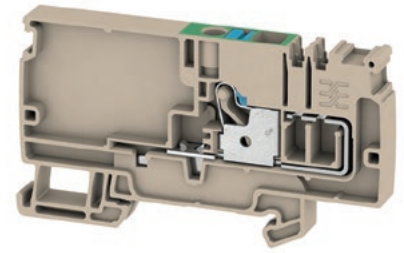

8.1 x 85.5 x 47
/ 6
0.34...6

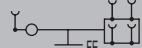

In accordance with IEC 60947-7-2

IEC	UL	CSA	EN 60079-7
	300	300	
6	AWG 22...8	AWG 22...8	
6 kV / 3			
A5 / V-0			
Rated connection			
0.5...6 / 0.5...6			
0.5...6 / 0.5...6			
12 / 1.0 x 5.5 mm			
Note			

Type	Qty.	Order No.
AAP11 6 FE	20	1988140000
Note		

Type	Qty.	Order No.
ZQV 1.5N/2 RD	17.5 A 60	1985650000
ZQV 1.5N/10 RD	17.5 A 20	1985800000
ZQV 1.5N/2 BL	17.5 A 60	1985530000
ZQV 1.5N/10 BL	17.5 A 20	1985680000
AEP AP11	20	1988320000
AEB 35 SC/1	50	1991920000
AEB 35 SCL/1 VO	20	2661280000
ATPG 1.5-10 L	0.2 A 50	1991890000
PS 2.0 MC	20	0310000000
SDIL 1,0X5,5X125	1	2749160000
DEK-A 5/8 MM WS	500	2448860000
WS-A 8/8 MM WS	500	2448930000
DEK 5/8 PLUS MC NE WS	800	1046350000
WS 10/8 PLUS MC NE WS	420	1905950000
Note		

For detailed information on other accessories and application in the online catalogue



AAP11 6/6X1.5 LO-LI

6 mm²

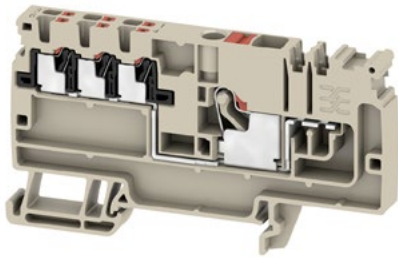

8.1 x 85.5 x 47
41 / 6
0.34...6

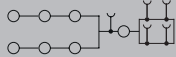

IEC 60947-7-1

IEC	UL	CSA	EN 60079-7
500	300	300	
41	38	38	
6	AWG 26...8	AWG 26...8	
6 kV / 3			
A5 / V-0			



Rated connection

0.5...6 / 0.5...6
0.5...6 / 0.5...6
12 / 1.0 x 5.5 mm

AAP11 6/6X1.5 PE-LI

6 mm²

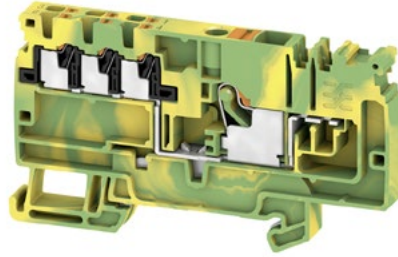

8.1 x 85.5 x 47
/ 6
0.34...6

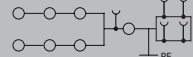

IEC 60947-7-2

IEC	UL	CSA	EN 60079-7
	300		
6	AWG 26...8	AWG 26...8	
6 kV / 3			
A5 / V-0			



Rated connection

0.5...6 / 0.5...6
0.5...6 / 0.5...6
12 / 1.0 x 5.5 mm

AAP11 1.5 LI

1.5 mm²

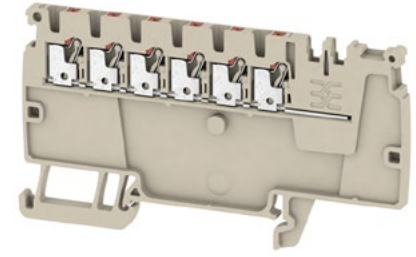

3.5 x 85.5 x 47
17.5 / 1.5
0.14...1.5

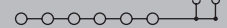

IEC 60947-7-1

IEC	UL	CSA	EN 60079-7
500	300	300	
17.5	13	13	
1.5	AWG 26...14	AWG 26...14	
6 kV / 3			
A1 / V-0			



Rated connection

0.5...1.5 / 0.5...1.5
0.5...1.5 / 0.5...1
8 / 0.4 x 2.0 mm

Type	Qty.	Order No.
AAP11 6/6X1.5 LO-LI RD	20	2464690000
AAP11 6/6X1.5 LO-LI BL	20	2464750000
AAP11 6/6X1.5 LO-LI OR	20	2503870000
AAP11 6/6X1.5 LO-LI WT	20	2712960000
AAP11 6/6X1.5 LO-LI BL/OR	20	2522830000

Type	Qty.	Order No.
AAP11 6/6X1.5 PE-LI	20	2464740000

Type	Qty.	Order No.
AAP11 1.5 LI RD	50	1988160000
AAP11 1.5 LI BL	50	1988170000
AAP11 1.5 LI OR	50	2503910000
AAP11 1.5 LI WT	50	2683440000
AAP11 1.5 LI BL/OR	50	2522870000
AAP11 1.5 LI GN/OR	50	2614100000

Type	Qty.	Order No.
ZQV 1.5N/2 RD	17.5 A 60	1985650000
ZQV 1.5N/10 RD	17.5 A 20	1985800000
ZQV 1.5N/2 BL	17.5 A 60	1985530000
ZQV 1.5N/10 BL	17.5 A 20	1985680000
AEP AP11	20	1988320000
AEB 35 SC/1	50	1991920000
AEB 35 SCL/1 V0	20	2661280000
ATPG 1.5-10 L	0.2 A 50	1991890000
PS 2.0 MC	20	0310000000
SDIL 1,0X5,5X125	1	2749160000
DEK-A 5/8 MM WS	500	2448860000
WS-A 8/8 MM WS	500	2448930000
DEK 5/8 PLUS MC NE WS	800	1046350000
WS 10/8 PLUS MC NE WS	420	1905950000

Type	Qty.	Order No.
ZQV 1.5N/2 RD	17.5 A 60	1985650000
ZQV 1.5N/10 RD	17.5 A 20	1985800000
ZQV 1.5N/2 BL	17.5 A 60	1985530000
ZQV 1.5N/10 BL	17.5 A 20	1985680000
AEP AP11	20	1988320000
AEB 35 SC/1	50	1991920000
AEB 35 SCL/1 V0	20	2661280000
ATPG 1.5-10 L	0.2 A 50	1991890000
PS 2.0 MC	20	0310000000
SDIL 1,0X5,5X125	1	2749160000
DEK-A 5/8 MM WS	500	2448860000
WS-A 8/8 MM WS	500	2448930000
DEK 5/8 PLUS MC NE WS	800	1046350000
WS 10/8 PLUS MC NE WS	420	1905950000

Type	Qty.	Order No.
ZQV 1.5N/2 RD	17.5 A 60	1985650000
ZQV 1.5N/10 RD	17.5 A 20	1985800000
ZQV 1.5N/2 BL	17.5 A 60	1985530000
ZQV 1.5N/10 BL	17.5 A 20	1985680000
AEP AP11	20	1988320000
AEB 35 SC/1	50	1991920000
AEB 35 SCL/1 V0	20	2661280000
SDIS 0.4X2.0X60	1	2749780000
WS 10/3.5 PLUS MC NE WS	960	2003760000
DEK 5/3.5 MM WS	1000	2007100000
DEK 5/3.5 PLUS MC NE WS	1600	2003750000

Control voltage distribution PUSH IN connection

AAP – potential distribution terminal blocks

Potential distribution with separate fusing



Width/Height/Depth	mm
max. current / max. cond. cross-section	A/mm ²
Max. clamping range	mm ²

Technical data

Rated data	
Rated voltage of feed-through terminal	V
Rated current	A
for wire cross-section	mm ²
Rated impulse withstand voltage / Pollution severity	
Gauge to IEC 60947-1 / UL 94 flammability rating	
Approvals	
Clamped conductors (H05V/H07V)	
Solid / Stranded	mm ²
Flexible / Flexible with ferrule	mm ²
Stripping length / Blade size	mm/-

Note

Ordering data

Version	
	beige / red and blue pusher
	beige / orange and orange pusher
Note	

Accessories

Plug-in cross-connection	
	2-pole/ red
	10-pole / red
	2-pole / blue
	10-pole/ blue
End plate / Partition plate	
End bracket	
	dark beige, screwable
	dark beige, direct mounting
Test adapter	
	1-pole
Test plug	
Screwdriver	
	Standard
Marking tags	

For detailed information on other accessories and application in the online catalogue

AAP13 6 LO-LO

6 mm²

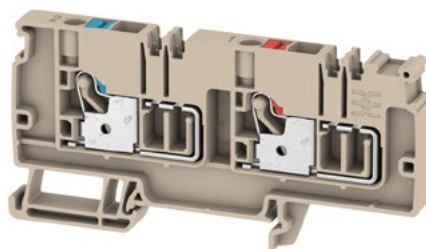

8.1 x 96 x 47	
41 / 6	
0.34...6	

In accordance with IEC 60947-7-1

IEC	UL	CSA	EN 60079-7
250	150	150	
41	36	36	
6	AWG 22...8	AWG 22...8	
4 kV / 3			
A5 / V-0			

Rated connection	
0.5...6 / 0.5...6	
0.5...6 / 0.5...6	
12 / 1.0 x 5.5 mm	

Type	Qty.	Order No.
AAP13 6 LO-LO	20	1988260000

Type	Qty.	Order No.
ZQV 1.5N/2 RD	17.5 A 60	1985650000
ZQV 1.5N/10 RD	17.5 A 20	1985800000
ZQV 1.5N/2 BL	17.5 A 60	1985530000
ZQV 1.5N/10 BL	17.5 A 20	1985680000
AEP AP13	20	1990140000
AEB 35 SC/1	50	1991920000
AEB 35 SCL/1 V0	20	2661280000
ATPG 1.5-10 L	0.2 A 50	1991890000
PS 2.0 MC	20	0310000000
SDIL 1,0X5,5X125	1	2749160000
DEK-A 5/8 MM WS	500	2448860000
WS-A 8/8 MM WS	500	2448930000
DEK 5/8 PLUS MC NE WS	800	1046350000
WS 10/8 PLUS MC NE WS	420	1905950000

AAP13 6 FE-LO

6 mm²

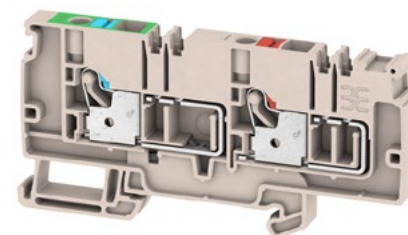

8.1 x 96 x 47	
41 / 6	
0.34...6	

In accordance with IEC 60947-7-2

IEC	UL	CSA	EN 60079-7
250	150	150	
41	36	36	
6	AWG 22...8	AWG 22...8	
4 kV / 3			
A5 / V-0			

Rated connection	
0.5...6 / 0.5...6	
0.5...6 / 0.5...6	
12 / 1.0 x 5.5 mm	

Type	Qty.	Order No.
AAP13 6 FE-LO	20	1988270000

Type	Qty.	Order No.
ZQV 1.5N/2 RD	17.5 A 60	1985650000
ZQV 1.5N/10 RD	17.5 A 20	1985800000
ZQV 1.5N/2 BL	17.5 A 60	1985530000
ZQV 1.5N/10 BL	17.5 A 20	1985680000
AEP AP13	20	1990140000
AEB 35 SC/1	50	1991920000
AEB 35 SCL/1 V0	20	2661280000
ATPG 1.5-10 L	0.2 A 50	1991890000
PS 2.0 MC	20	0310000000
SDIL 1,0X5,5X125	1	2749160000
DEK-A 5/8 MM WS	500	2448860000
WS-A 8/8 MM WS	500	2448930000
DEK 5/8 PLUS MC NE WS	800	1046350000
WS 10/8 PLUS MC NE WS	420	1905950000



AAP13 1.5 LI-LI

1.5 mm²

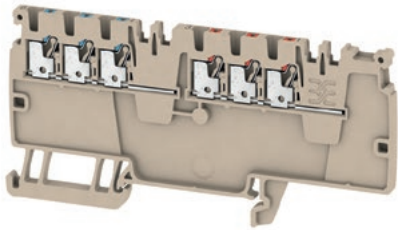

3.5 x 96 x 47
16 / 1.5
0.14...1.5



IEC 60947-7-1

IEC	UL	CSA	EN 60079-7
250	150	150	
16	13	13	
1.5	AWG 26...14	AWG 26...14	
4 kV / 3			
A1 / V-0			



Rated connection

0.5...1.5 / 0.5...1.5
0.5...1.5 / 0.5...1
8 / 0.4 x 2.0 mm

Type	Qty.	Order No.
AAP13 1.5 LI-LI	50	1988280000

Type	Qty.	Order No.
ZQV 1.5N/2 RD	17.5 A 60	1985650000
ZQV 1.5N/10 RD	17.5 A 20	1985800000
ZQV 1.5N/2 BL	17.5 A 60	1985530000
ZQV 1.5N/10 BL	17.5 A 20	1985680000
AEP AP13	20	1990140000
AEB 35 SC/1	50	1991920000
AEB 35 SCL/1 V0	20	2661280000
SDIS 0.4X2.0X60	1	2749780000
WS 8/3.5 MM WS	1000	2007140000
DEK 5/3.5 MM WS	1000	2007100000
DEK 5/3.5 PLUS MC NE WS	1600	2003750000

AAP13 6 LO-LO OR

6 mm²

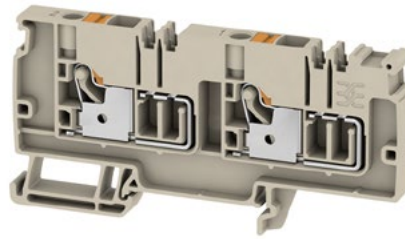

8.1 x 96 x 47
41 / 6
0.34...6



In accordance with IEC 60947-7-1

IEC	UL	CSA	EN 60079-7
250			
41			
6			
4 kV / 3			
A5 / V-0			



Rated connection

0.5...6 / 0.5...6
0.5...6 / 0.5...6
12 / 1.0 x 5.5 mm

Type	Qty.	Order No.
AAP13 6 LO-LO OR	20	2623910000

Type	Qty.	Order No.
ZQV 1.5N/2 RD	17.5 A 60	1985650000
ZQV 1.5N/10 RD	17.5 A 20	1985800000
ZQV 1.5N/2 BL	17.5 A 60	1985530000
ZQV 1.5N/10 BL	17.5 A 20	1985680000
AEP AP13	20	1990140000
AEB 35 SC/1	50	1991920000
AEB 35 SCL/1 V0	20	2661280000
ATPG 1.5-10 L	0.2 A 50	1991890000
PS 2.0 MC	20	0310000000
SDIL 1,0X5,5X125	1	2749160000
DEK-A 5/8 MM WS	500	2448860000
WS-A 8/8 MM WS	500	2448930000
DEK 5/8 PLUS MC NE WS	800	1046350000
WS 10/8 PLUS MC NE WS	420	1905950000

AAP13 1.5 LI-LI OR

1.5 mm²

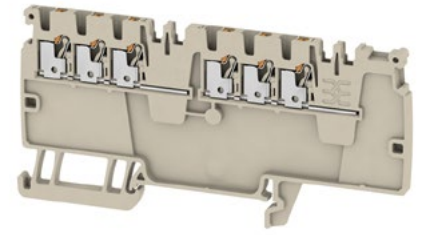

3.5 x 96 x 47
16 / 1.5
0.14...1.5



IEC 60947-7-1

IEC	UL	CSA	EN 60079-7
250			
16			
1.5			
A1 / V-0			



Rated connection

0.5...1.5 / 0.5...1.5
0.5...1.5 / 0.5...1
8 /

Type	Qty.	Order No.
AAP13 1.5 LI-LI OR	50	2623920000

Type	Qty.	Order No.
ZQV 1.5N/2 RD	17.5 A 60	1985650000
ZQV 1.5N/10 RD	17.5 A 20	1985800000
ZQV 1.5N/2 BL	17.5 A 60	1985530000
ZQV 1.5N/10 BL	17.5 A 20	1985680000
AEP AP13	20	1990140000
AEB 35 SC/1	50	1991920000
AEB 35 SCL/1 V0	20	2661280000
SDIS 0.4X2.0X60	1	2749780000
WS 8/3.5 MM WS	1000	2007140000
DEK 5/3.5 MM WS	1000	2007100000
DEK 5/3.5 PLUS MC NE WS	1600	2003750000



Control voltage distribution PUSH IN connection

AAP – potential distribution terminal blocks

SET AAP11 6/1.5/12C

6 mm²

SET AAP11 6/1.5/24C

6 mm²

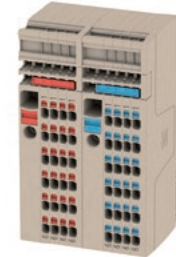

Width/Height/Depth	mm
max. current / max. cond. cross-section	A/mm ²
Max. clamping range	mm ²

35 x 85.5 x 47
35 / 6
0.34...6

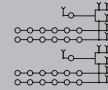

49 x 85.5 x 47
41 / 6
0.34...6

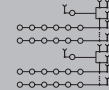

Technical data

Rated data	
Rated voltage of feed-through terminal	V
Rated current	A
for wire cross-section	mm ²
Rated impulse withstand voltage / Pollution severity	
Gauge to IEC 60947-1 / UL 94 flammability rating	
Approvals	
Clamped conductors (H05V/H07V)	
Solid / Stranded	mm ²
Flexible / Flexible with ferrule	mm ²
Stripping length / Blade size	mm/-
Note	

In accordance with IEC 60947-7-1

IEC	UL	CSA	EN 60079-7
500			
35			
6			
		6 kV / 3	
		A5 / V-0	
C€			
Rated connection			
0.5...6 / 0.5...6			
0.5...6 / 0.5...6			
12 / 1.0 x 5.5 mm			
Note			

In accordance with IEC 60947-7-1

IEC	UL	CSA	EN 60079-7
500			
41			
6			
		6 kV / 3	
		A5 / V-0	
C€			
Rated connection			
0.5...6 / 0.5...6			
0.5...6 / 0.5...6			
12 / 1.0 x 5.5 mm			
Note			

Ordering data

Version
Note

Type	Qty.	Order No.
SET AAP11 6/1.5/12C	1	2506090000
Note		

Type	Qty.	Order No.
SET AAP11 6/1.5/24C	1	2506370000
Note		

Accessories

Plug-in cross-connection	
	2-pole/ red
	10-pole / red
End bracket	
	dark beige, screwable
	dark beige, direct mounting
Tools	
	Tester
Marking tags	

Type	Qty.	Order No.
ZQV 1.5N/2 RD	17.5 A 60	1985650000
ZQV 1.5N/10 RD	17.5 A 20	1985800000
AEB 35 SC/1		
	50	1991920000
AEB 35 SCL/1 VO		
	20	2661280000
ZUB MULTIMETER		
	1	9205270000
WS 8/3.5 MM WS		
	1000	2007140000
DEK 5/3.5 PLUS MC NE WS		
	1600	2003750000
WS-A 8/8 MM WS		
	500	2448930000
DEK 5/8 PLUS MC NE WS		
	800	1046350000

Type	Qty.	Order No.
ZQV 1.5N/2 RD	17.5 A 60	1985650000
ZQV 1.5N/10 RD	17.5 A 20	1985800000
AEB 35 SC/1		
	50	1991920000
AEB 35 SCL/1 VO		
	20	2661280000
ZUB MULTIMETER		
	1	9205270000
WS 8/3.5 MM WS		
	1000	2007140000
DEK 5/3.5 PLUS MC NE WS		
	1600	2003750000
WS-A 8/8 MM WS		
	500	2448930000
DEK 5/8 PLUS MC NE WS		
	800	1046350000

For detailed information on other accessories and application in the online catalogue



AAP – potential distribution terminal blocks

SET AAP13 6/1.5/12C

6 mm²

SET AAP13 6/1.5/24C

6 mm²



Width/Height/Depth	mm
max. current / max. cond. cross-section	A/mm ²
Max. clamping range	mm ²

24.5 x 96 x 47
41 / 6
0.34...6

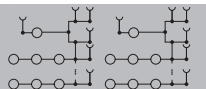

38.5 x 96 x 47
41 / 6
0.34...6

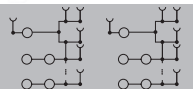

Technical data

Rated data	
Rated voltage of feed-through terminal	V
Rated current	A
for wire cross-section	mm ²
Rated impulse withstand voltage / Pollution severity	
Gauge to IEC 60947-1 / UL 94 flammability rating	
Approvals	
Clamped conductors (H05V/H07V)	
Solid / Stranded	mm ²
Flexible / Flexible with ferrule	mm ²
Stripping length / Blade size	mm/-

In accordance with IEC 60947-7-1

IEC	UL	CSA	EN 60079-7
250			
41			
6			
		4 kV / 3	
		A5 / V-0	
CE			
Rated connection			
0.5...6 / 0.5...6			
0.5...6 / 0.5...6			
12 / 1.0 x 5.5 mm			

In accordance with IEC 60947-7-1

IEC	UL	CSA	EN 60079-7
250			
41			
6			
		4 kV / 3	
		A5 / V-0	
CE			
Rated connection			
0.5...6 / 0.5...6			
0.5...6 / 0.5...6			
12 / 1.0 x 5.5 mm			

Note

Ordering data

Version
Note

Type	Qty.	Order No.
SET AAP13 6/1.5/12C	1	2506340000

Type	Qty.	Order No.
SET AAP13 6/1.5/24C	1	2506380000

Accessories

Plug-in cross-connection	
	2-pole/ red
	10-pole / red
End bracket	
	dark beige, screwable
	dark beige, direct mounting
Tools	
	Tester
Marking tags	

Type	Qty.	Order No.
ZQV 1.5N/2 RD	17.5 A 60	1985650000
ZQV 1.5N/10 RD	17.5 A 20	1985800000
AEB 35 SC/1	50	1991920000
AEB 35 SCL/1 VO	20	2661280000
ZUB MULTIMETER	1	9205270000
WS 8/3.5 MM WS	1000	2007140000
DEK 5/3.5 PLUS MC NE WS	1600	2003750000
WS-A 8/8 MM WS	500	2448930000
DEK 5/8 PLUS MC NE WS	800	1046350000

Type	Qty.	Order No.
ZQV 1.5N/2 RD	17.5 A 60	1985650000
ZQV 1.5N/10 RD	17.5 A 20	1985800000
AEB 35 SC/1	50	1991920000
AEB 35 SCL/1 VO	20	2661280000
ZUB MULTIMETER	1	9205270000
WS 8/3.5 MM WS	1000	2007140000
DEK 5/3.5 PLUS MC NE WS	1600	2003750000
WS-A 8/8 MM WS	500	2448930000
DEK 5/8 PLUS MC NE WS	800	1046350000

For detailed information on other accessories and application in the online catalogue

Control voltage distribution PUSH IN connection

AAP – potential distribution terminal blocks

Potential distribution with separate fusing



Width/Height/Depth	mm
max. current / max. cond. cross-section	A/mm ²
Max. clamping range	mm ²

Technical data

Rated data	
Rated voltage of feed-through terminal	V
Rated current	A
for wire cross-section	mm ²
Rated impulse withstand voltage / Pollution severity	
Gauge to IEC 60947-1 / UL 94 flammability rating	
Approvals	
Clamped conductors (H05V/H07V)	
Solid / Stranded	mm ²
Flexible / Flexible with ferrule	mm ²
Stripping length / Blade size	mm/-

Note

Ordering data

Version	
	beige / red pusher
	beige / blue pusher
	beige / orange pusher
	beige / white pusher
	green-yellow / orange pusher
	blue / orange pusher
	green / orange pusher

Note

Accessories

Plug-in cross-connection	
	2-pole/ red
	10-pole/ red
	2-pole/ blue
	10-pole/ blue

End plate / Partition plate

End bracket

	dark beige, screwable
	dark beige, direct mounting

Test adapter

	1-pole
--	--------

Test plug

Screwdriver

	Standard
--	----------

Marking tags

For detailed information on other accessories and application in the online catalogue

AAP12 10 LO

10 mm²

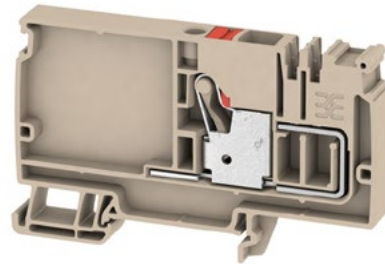

10 x 89 x 53.5	
57 / 10	
0.5...10	

In accordance with IEC 60947-7-1

IEC	UL	CSA	EN 60079-7
800	600	600	
57	51	51	
10	AWG 20...6	AWG 20...6	
8 kV / 3			
A6 / V-0			

Rated connection

0.5...10 / 0.5...10
0.5...10 / 0.5...10
18 / 1.0 x 5.5 mm

Type	Qty.	Order No.
AAP12 10 LO RD	20	1988190000
AAP12 10 LO BL	20	1988180000
AAP12 10 LO OR	20	2503900000
AAP12 10 LO WT	20	2683450000
AAP12 10 LO BL/OR	20	2522860000
AAP12 10 LO GN/OR	20	2619410000

Type	Qty.	Order No.
ZQV 2.5N/2 RD	24 A 60	2108470000
ZQV 2.5N/10 RD	24 A 20	2108910000
ZQV 2.5N/2 BL	24 A 60	1527740000
ZQV 2.5N/10 BL	24 A 20	1527880000
AEP AP12	20	1988300000
AEB 35 SC/1	50	1991920000
AEB 35 SCL/1 VO	20	2661280000
ATPG 1.5-10 L	0.2 A 50	1991890000
PS 2.0 MC	20	0310000000
SDIL 1,0X5,5X125	1	2749160000
DEK 5/5 PLUS MC NE WS	1000	1854490000
DEK 5/8 PLUS MC NE WS	800	1046350000
WS 10/8 PLUS MC NE WS	420	1905950000

AAP12 10 FE

10 mm²

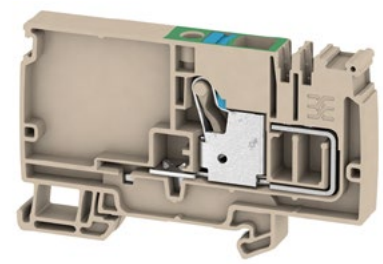

10 x 89 x 53.5	
/ 10	
0.5...10	

In accordance with IEC 60947-7-2

IEC	UL	CSA	EN 60079-7
	600	600	
10	AWG 20...6	AWG 20...6	
8 kV / 3			
A6 / V-0			

Rated connection

0.5...10 / 0.5...10
0.5...10 / 0.5...10
18 / 1.0 x 5.5 mm

Type	Qty.	Order No.
AAP12 10 FE	20	1988200000

Type	Qty.	Order No.
ZQV 2.5N/2 BL	24 A 60	1527740000
ZQV 2.5N/10 BL	24 A 20	1527880000
AEP AP12	20	1988300000
AEB 35 SC/1	50	1991920000
AEB 35 SCL/1 VO	20	2661280000
ATPG 1.5-10 L	0.2 A 50	1991890000
PS 2.0 MC	20	0310000000
SDIL 1,0X5,5X125	1	2749160000
DEK 5/5 PLUS MC NE WS	1000	1854490000
DEK 5/8 PLUS MC NE WS	800	1046350000
WS 10/8 PLUS MC NE WS	420	1905950000

For detailed information on other accessories and application in the online catalogue



AAP12 10/4X2.5 10 LO-LI

10 mm²

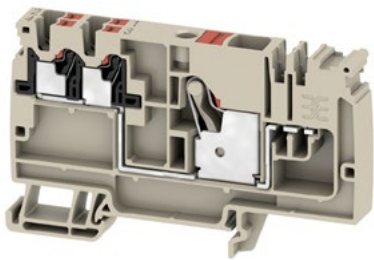

10 x 89 x 53.5
57 / 10
0.5...10

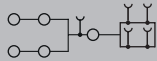

IEC 60947-7-1

IEC	UL	CSA	EN 60079-7
800	600	600	
57	55	55	
10	AWG 28...6	AWG 28...6	
8 kV / 3			
A6 / V-0			



Rated connection

0.5...10 / 0.5...10
0.5...10 / 0.5...10
18 / 1.0 x 5.5 mm

AAP12 10/4X2.5 PE-LI

10 mm²

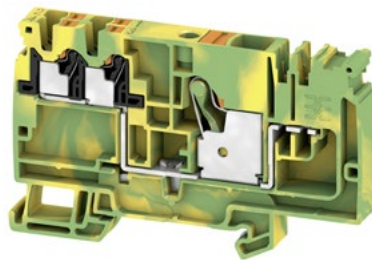

10 x 89 x 53.5
/ 10
0.5...10

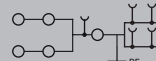

IEC 60947-7-2

IEC	UL	CSA	EN 60079-7
	600		
10	AWG 28...8	AWG 28...8	
8 kV / 3			
A6 / V-0			



Rated connection

0.5...10 / 0.5...10
0.5...10 / 0.5...10
18 / 1.0 x 5.5 mm

AAP12 2.5 LI

2.5 mm²

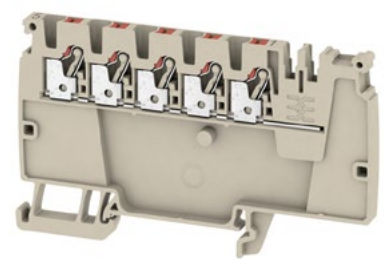

5.1 x 89 x 53.5
24 / 2.5
0.14...2.5

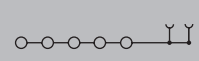

IEC 60947-7-1

IEC	UL	CSA	EN 60079-7
800	600	600	
24	20	20	
2.5	AWG 28...12	AWG 28...12	
8 kV / 3			
A3 / V-0			



Rated connection

0.5...2.5 / 0.5...2.5
0.5...2.5 / 0.5...2.5
10 / 0.6 x 3.5 mm

Type	Qty.	Order No.
AAP12 10/4X2.5 LO-LI RD	20	2464730000
AAP12 10/4X2.5 LO-LI BL	20	2464720000
AAP12 10/4X2.5 LO-LI OR	20	2503890000
AAP12 10/4X2.5 LO-LI WT	20	2712970000
AAP12 10/4X2.5 LO-LI BL/OR	20	2522850000

Type	Qty.	Order No.
AAP12 10/4X2.5 PE-LI	20	2464710000

Type	Qty.	Order No.
AAP12 2.5 LI RD	50	1988290000
AAP12 2.5 LI BL	50	1988100000
AAP12 2.5 LI OR	50	2503880000
AAP12 2.5 LI WT	50	2683460000
AAP12 2.5 LI BL/OR	50	2522840000
AAP12 2.5 LI GN/OR	50	2614110000

Type	Qty.	Order No.
ZQV 2.5N/2 RD	24 A 60	2108470000
ZQV 2.5N/10 RD	24 A 20	2108910000
ZQV 2.5N/2 BL	24 A 60	1527740000
ZQV 2.5N/10 BL	24 A 20	1527880000
AEP AP12	20	1988300000
AEB 35 SC/1	50	1991920000
AEB 35 SCL/1 VO	20	2661280000
ATPG 1.5-10 L	0.2 A 50	1991890000
PS 2.0 MC	20	0310000000
SDIL 1,0X5,5X125	1	2749160000
DEK 5/5 PLUS MC NE WS	1000	1854490000
DEK 5/8 PLUS MC NE WS	800	1046350000
WS 10/8 PLUS MC NE WS	420	1905950000

Type	Qty.	Order No.
ZQV 2.5N/2 RD	24 A 60	2108470000
ZQV 2.5N/10 RD	24 A 20	2108910000
ZQV 2.5N/2 BL	24 A 60	1527740000
ZQV 2.5N/10 BL	24 A 20	1527880000
AEP AP12	20	1988300000
AEB 35 SC/1	50	1991920000
AEB 35 SCL/1 VO	20	2661280000
ATPG 1.5-10 L	0.2 A 50	1991890000
PS 2.0 MC	20	0310000000
SDIL 1,0X5,5X125	1	2749160000
DEK 5/5 PLUS MC NE WS	1000	1854490000
DEK 5/8 PLUS MC NE WS	800	1046350000
WS 10/8 PLUS MC NE WS	420	1905950000

Type	Qty.	Order No.
ZQV 2.5N/2 RD	24 A 60	2108470000
ZQV 2.5N/10 RD	24 A 20	2108910000
ZQV 2.5N/2 BL	24 A 60	1527740000
ZQV 2.5N/10 BL	24 A 20	1527880000
AEP AP12	20	1988300000
AEB 35 SC/1	50	1991920000
AEB 35 SCL/1 VO	20	2661280000
ATPG 1.5-10 L	0.2 A 50	1991890000
PS 2.0 MC	20	0310000000
SDIL 0,6X3,5X100	1	2749140000
DEK 5/5 PLUS MC NE WS	1000	1854490000
DEK 5/5 MM WS	800	2007110000
WS 10/5 M PLUS MC NE WS	600	2003770000
WS 8/5 MM WS	800	2007150000

Control voltage distribution PUSH IN connection

AAP – potential distribution terminal blocks

Potential distribution with separate fusing



Width/Height/Depth	mm
max. current / max. cond. cross-section	A/mm ²
Max. clamping range	mm ²

Technical data

Rated data	
Rated voltage of feed-through terminal	V
Rated current	A
for wire cross-section	mm ²
Rated impulse withstand voltage / Pollution severity	
Gauge to IEC 60947-1 / UL 94 flammability rating	
Approvals	
Clamped conductors (H05V/H07V)	
Solid / Stranded	mm ²
Flexible / Flexible with ferrule	mm ²
Stripping length / Blade size	mm/-

Note

Ordering data

Version	beige / red and blue pusher
Note	

Accessories

Plug-in cross-connection	
	2-pole/ red
	10-pole / red
	2-pole / blue
	10-pole/ blue
End plate / Partition plate	
End bracket	
	dark beige, screwable
	dark beige, direct mounting
Test adapter	
	1-pole
Test plug	
Screwdriver	
	Standard
Marking tags	

For detailed information on other accessories and application in the online catalogue

AAP14 10 LO-LO

10 mm²

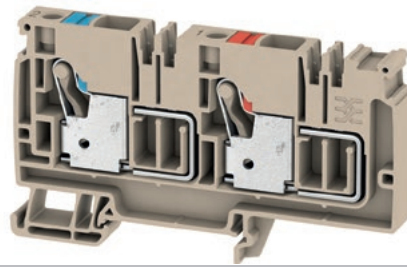

10 x 94 x 53.5	
57 / 10	
0.5...10	

In accordance with IEC 60947-7-1

IEC	UL	CSA	EN 60079-7
500	150	150	
57	51	51	
10	AWG 20...6	AWG 20...6	
6 kV / 3			
A6 / V-0			

Rated connection	
Solid / Stranded	mm ²
Flexible / Flexible with ferrule	mm ²
Stripping length / Blade size	mm/-

Note

Type	Qty.	Order No.
AAP14 10 LO-LO	20	1988250000

Type	Qty.	Order No.
ZQV 2.5N/2 RD	24 A 60	2108470000
ZQV 2.5N/10 RD	24 A 20	2108910000
ZQV 2.5N/2 BL	24 A 60	1527740000
ZQV 2.5N/10 BL	24 A 20	1527880000
AEP AP14	20	1988340000
AEB 35 SC/1	50	1991920000
AEB 35 SCL/1 VO	20	2661280000
ATPG 1.5-10 L	0.2 A 50	1991890000
PS 2.0 MC	20	0310000000
SDIL 1,0X5,5X125	1	2749160000
DEK 5/5 PLUS MC NE WS	1000	1854490000
DEK 5/8 PLUS MC NE WS	800	1046350000
WS 10/8 PLUS MC NE WS	420	1905950000

AAP14 10 FE-LO

10 mm²

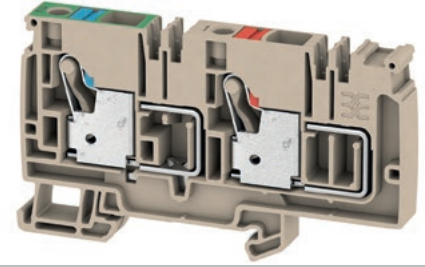

10 x 94 x 53.5	
57 / 10	
0.5...10	

In accordance with IEC 60947-7-2

IEC	UL	CSA	EN 60079-7
500	150	300	
57	51	51	
10	AWG 20...6	AWG 20...6	
6 kV / 3			
A6 / V-0			

Rated connection	
Solid / Stranded	mm ²
Flexible / Flexible with ferrule	mm ²
Stripping length / Blade size	mm/-

Note

Type	Qty.	Order No.
AAP14 10 FE-LO	20	1988240000

Type	Qty.	Order No.
ZQV 2.5N/2 RD	24 A 60	2108470000
ZQV 2.5N/10 RD	24 A 20	2108910000
ZQV 2.5N/2 BL	24 A 60	1527740000
ZQV 2.5N/10 BL	24 A 20	1527880000
AEP AP14	20	1988340000
AEB 35 SC/1	50	1991920000
AEB 35 SCL/1 VO	20	2661280000
ATPG 1.5-10 L	0.2 A 50	1991890000
PS 2.0 MC	20	0310000000
SDIL 1,0X5,5X125	1	2749160000
DEK 5/5 PLUS MC NE WS	1000	1854490000
DEK 5/8 PLUS MC NE WS	800	1046350000
WS 10/8 PLUS MC NE WS	420	1905950000

For detailed information on other accessories and application in the online catalogue



AAP14 2.5 LI-LI

2.5 mm²

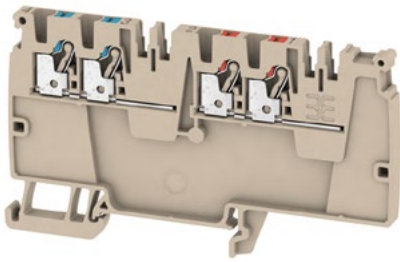

5.1 x 94 x 53.5
24 / 2.5
0.14...2.5



IEC 60947-7-1

IEC	UL	CSA	EN 60079-7
500	150	150	
24	20	20	
2.5	AWG 28...12	AWG 28...12	
6 kV / 3			
A3 / V-0			

® CE CB TÜV SÜD IEC

Rated connection

0.5...2.5 / 0.5...2.5

0.5...2.5 / 0.5...2.5

10 / 0.6 x 3.5 mm

Type	Qty.	Order No.
AAP14 2.5 LI-LI	50	1988230000

Type	Qty.	Order No.
ZQV 2.5N/2 RD	24 A 60	2108470000
ZQV 2.5N/10 RD	24 A 20	2108910000
ZQV 2.5N/2 BL	24 A 60	1527740000
ZQV 2.5N/10 BL	24 A 20	1527880000
AEP AP14	20	1988340000
AEB 35 SC/1	50	1991920000
AEB 35 SCL/1 VO	20	2661280000
SDIL 0,6X3,5X100	1	2749140000
DEK 5/5 PLUS MC NE WS	1000	1854490000
DEK 5/5 MM WS	800	2007110000
WS 10/5 M PLUS MC NE WS	600	2003770000
WS 8/5 MM WS	800	2007150000



**Control voltage distribution
PUSH IN connection**

AAP – potential distribution terminal blocks

SET AAP12 10/2.5/10C

10 mm²



Width/Height/Depth	mm
max. current / max. cond. cross-section	A/mm ²
Max. clamping range	mm ²

45.2 x 89 x 53.5
48 / 10
0.5...10

Technical data

Rated data	
Rated voltage of feed-through terminal	V
Rated current	A
for wire cross-section	mm ²
Rated impulse withstand voltage / Pollution severity	
Gauge to IEC 60947-1 / UL 94 flammability rating	
Approvals	
Clamped conductors (H05V/H07V)	
Solid / Stranded	mm ²
Flexible / Flexible with ferrule	mm ²
Stripping length / Blade size	mm/-

In accordance with IEC 60947-7-1

IEC	UL	CSA	EN 60079-7
800			
48			
10			
		8 kV / 3	
		A6 / V-0	

CE

Rated connection	
0.5...10 / 0.5...10	
0.5...10 / 0.5...10	
18 / 1.0 x 5.5 mm	

Note

Ordering data

Version
Note

Type	Qty.	Order No.
SET AAP12 10/2.5/10C	1	2506350000

Accessories

Plug-in cross-connection	
	2-pole/ red
	10-pole / red
End bracket	
	dark beige, screwable
	dark beige, direct mounting
Tools	
	Tester
Marking tags	

Type	Qty.	Order No.
ZQV 2.5N/2 RD	24 A 60	2108470000
ZQV 2.5N/10 RD	24 A 20	2108910000
AEB 35 SC/1	50	1991920000
AEB 35 SCL/1 V0	20	2661280000
ZUB MULTIMETER	1	9205270000
DEK 5/5 PLUS MC NE WS	1000	1854490000
DEK 5/8 PLUS MC NE WS	800	1046350000
WS 8/5 MM WS	800	2007150000

For detailed information on other accessories and application in the online catalogue



AAP – potential distribution terminal blocks

SET AAP14 10/2.5/10C

10 mm²



Width/Height/Depth	mm
max. current / max. cond. cross-section	A/mm ²
Max. clamping range	mm ²

36.5 x 89 x 53.5
57 / 10
0.5...10

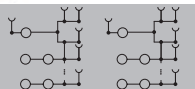

Technical data

Rated data	
Rated voltage of feed-through terminal	V
Rated current	A
for wire cross-section	mm ²
Rated impulse withstand voltage / Pollution severity	
Gauge to IEC 60947-1 / UL 94 flammability rating	
Approvals	
Clamped conductors (H05V/H07V)	
Solid / Stranded	mm ²
Flexible / Flexible with ferrule	mm ²
Stripping length / Blade size	mm/-

In accordance with IEC 60947-7-1

IEC	UL	CSA	EN 60079-7
500			
57			
10			
8 kV / 3			
A6 / V-0			
C E			
Rated connection			
0.5...10 / 0.5...10			
0.5...10 / 0.5...10			
18 / 1.0 x 5.5 mm			

Note

Ordering data

Version
Note

Type	Qty.	Order No.
SET AAP14 10/2.5/10C	1	2506360000

Accessories

Plug-in cross-connection	2-pole/ red 10-pole / red
End bracket	dark beige, screwable dark beige, direct mounting
Tools	Tester
Marking tags	

Type	Qty.	Order No.
ZQV 2.5N/2 RD	24 A 60	2108470000
ZQV 2.5N/10 RD	24 A 20	2108910000
AEB 35 SC/1	50	1991920000
AEB 35 SCL/1 V0	20	2661280000
ZUB MULTIMETER	1	9205270000
DEK 5/5 PLUS MC NE WS	1000	1854490000
DEK 5/8 PLUS MC NE WS	800	1046350000
WS 8/5 MM WS	800	2007150000

For detailed information on other accessories and application in the online catalogue



Control voltage distribution PUSH IN connection

AAP – potential distribution terminal blocks

Potential distribution with separate fusing



Width/Height/Depth	mm
max. current / max. cond. cross-section	A/mm ²
Max. clamping range	mm ²

Technical data

Rated data	
Rated voltage	V
Rated current	A
for wire cross-section	mm ²
Rated impulse withstand voltage / Pollution severity	
UL 94 flammability rating	
Approvals	
Clamped conductors (H05V/H07V)	
Solid / Stranded	mm ²
Flexible / Flexible with ferrule	mm ²
Stripping length	
Blade size	

Note

Ordering data

Version	
	beige / red pusher
	beige / blue pusher
	beige / orange pusher
	blue / orange pusher

Note

Accessories

Plug-in cross-connection	
	2-pole/ red
	10-pole / red
	2-pole / blue
	10-pole/ blue
End plate / Partition plate	
End bracket	
	dark beige, screwable
	dark beige, direct mounting
	dark beige
Test adapter	
	1-pole
Test plug	
Screwdriver	
	Standard
Marking tags	

For detailed information on other accessories and application in the online catalogue

AAP21 10 LO

10 mm²

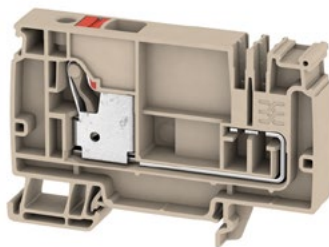

12 x 82 x 53.5
57 / 10
0.5...10

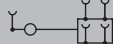

Ex ec II C Gc II

2 G D



In accordance with IEC 60947-7-1

IEC	UL	CSA	EN 60079-7
250	600 (C)	600 (C)	
57	51	51	57
10	AWG 20...6	AWG 20...6	10

4 kV / 3
V-0

© CE e TÜV SÜD TÜEV17ATEX8063U

Rated connection
0.5...10 / 0.5...10
0.5...10 / 0.5...10
18 mm
1.0 x 5.5 mm

Type	Qty.	Order No.
AAP21 10 LO RD	20	2428910000
AAP21 10 LO BL	20	2428940000
AAP21 10 LO OR	20	2581690000

Type	Qty.	Order No.
ZQV 4N/2 RD	32 A 60	2460450000
ZQV 4N/10 RD	32 A 20	2460740000
ZQV 4N/2 BL	32 A 60	1528040000
ZQV 4N/10 BL	32 A 20	1528230000

Type	Qty.	Order No.
AEP AP21	20	2429020000
AEB 35 SC/1	50	1991920000
AEB 35 SCL/1 V0	20	2661280000

Type	Qty.	Order No.
ATPG 1.5-10 L	0.2 A 50	1991890000

Type	Qty.	Order No.
PS 2.0 MC	20	0310000000

Type	Qty.	Order No.
SDIL 0,6X3,5X100	1	2749140000

Type	Qty.	Order No.
DEK 5/5 PLUS MC NE WS	1000	1854490000
DEK 5/8 PLUS MC NE WS	800	1046350000
WS 10/8 PLUS MC NE WS	420	1905950000

AAP21 10 FE

10 mm²

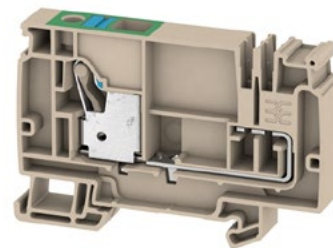

12 x 82 x 53.5
/ 10
0.5...10



Ex ec II C Gc II

2 G D



In accordance with IEC 60947-7-2

IEC	UL	CSA	EN 60079-7
	600 (C)	600 (C)	
			57
10	AWG 20...6	AWG 20...6	10 mm ²

4 kV / 3
V-0

© CE e TÜV SÜD TÜEV17ATEX8063U

Rated connection
0.5...10 / 0.5...10
0.5...10 / 0.5...10
18 mm
1.0 x 5.5 mm

Type	Qty.	Order No.
AAP21 10 FE	20	2428920000

Type	Qty.	Order No.
ZQV 4N/2 RD	32 A 60	2460450000
ZQV 4N/10 RD	32 A 20	2460740000
ZQV 4N/2 BL	32 A 60	1528040000
ZQV 4N/10 BL	32 A 20	1528230000

Type	Qty.	Order No.
AEP AP21	20	2429020000
AEB 35 SC/1	50	1991920000
AEB 35 SCL/1 V0	20	2661280000

Type	Qty.	Order No.
ATPG 1.5-10 L	0.2 A 50	1991890000

Type	Qty.	Order No.
PS 2.0 MC	20	0310000000

Type	Qty.	Order No.
SDIL 0,6X3,5X100	1	2749140000

Type	Qty.	Order No.
DEK 5/5 PLUS MC NE WS	1000	1854490000
DEK 5/8 PLUS MC NE WS	800	1046350000
WS 10/8 PLUS MC NE WS	420	1905950000



AAP21 10 LO

10 mm²

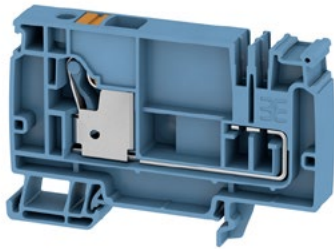

12 x 82 x 53.5
57 / 10
0.5...10

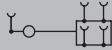

Ex ec II C Gc II
2 G D

In accordance with IEC 60947-7-1



IEC	UL	CSA	EN 60079-7
250	600 (C)	600 (C)	
57	51	51	57
10	AWG 20...6	AWG 20...6	10

4 kV / 3

V-0



TUEV17ATEX8063U

Rated connection

0.5...10 / 0.5...10

0.5...10 / 0.5...10

18 mm

1.0 x 5.5 mm

AAP21 4 LI

4 mm²

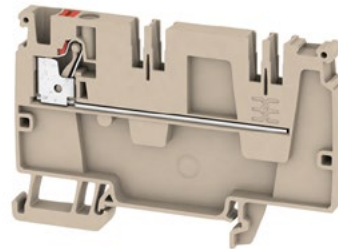

6.1 x 82 x 53.5
32 / 4
0.14...4

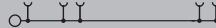

Ex ec II C Gc II
2 G D

In accordance with IEC 60947-7-1



IEC	UL	CSA	EN 60079-7
250	300 (C)	300 (C)	
32	20	20	32
4	AWG 26...10	AWG 26...10	4 mm ²

4 kV / 3

V-0



TUEV17ATEX8063U

Rated connection

0.5...4 / 0.5...4

0.5...4 / 0.5...4

12 mm

0.6 x 3.5 mm

AAP21 4 LI

4 mm²

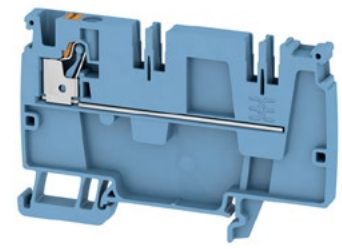

6.1 x 82 x 53.5
32 / 4
0.14...4

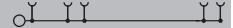

Ex ec II C Gc II
2 G D

In accordance with IEC 60947-7-1



IEC	UL	CSA	EN 60079-7
250	300 (C)	300 (C)	
32	20	20	32
4	AWG 26...10	AWG 26...10	4 mm ²

4 kV / 3

V-0



TUEV17ATEX8063U

Rated connection

0.5...4 / 0.5...4

0.5...4 / 0.5...4

12 mm

0.6 x 3.5 mm

Type	Qty.	Order No.
AAP21 10 LO BL/OR	20	2581800000

Type	Qty.	Order No.
AAP21 4 LI RD	50	2428930000
AAP21 4 LI BL	50	2428960000
AAP21 4 LI OR	50	2581700000

Type	Qty.	Order No.
AAP21 4 LI BL/OR	50	2582530000

Type	Qty.	Order No.
ZQV 4N/2 RD	32 A 60	2460450000
ZQV 4N/10 RD	32 A 20	2460740000
ZQV 4N/2 BL	32 A 60	1528040000
ZQV 4N/10 BL	32 A 20	1528230000
AEP AP21	20	2429020000
AEB 35 SC/1	50	1991920000
AEB 35 SCL/1 VO	20	2661280000
ATPG 1.5-10 L	0.2 A 50	1991890000
PS 2.0 MC	20	0310000000
SDIL 0,6X3,5X100	1	2749140000
DEK 5/5 PLUS MC NE WS	1000	1854490000
DEK 5/8 PLUS MC NE WS	800	1046350000
WS 10/8 PLUS MC NE WS	420	1905950000

Type	Qty.	Order No.
ZQV 4N/2 RD	32 A 60	2460450000
ZQV 4N/10 RD	32 A 20	2460740000
ZQV 4N/2 BL	32 A 60	1528040000
ZQV 4N/10 BL	32 A 20	1528230000
AEP AP21	20	2429020000
AEB 35 SC/1	50	1991920000
ZEW 35/2	20	8630740000
ATPG 1.5-10 L	0.2 A 50	1991890000
PS 2.0 MC	20	0310000000
SDIL 0,6X3,5X100	1	2749140000
WS 10/6 M PLUS MC NE WS	600	2003780000
DEK 5/6 MM WS	600	2007120000
DEK 5/6 PLUS MC NE WS	1000	1011320000
WS 8/6 MM WS	600	2007160000

Type	Qty.	Order No.
ZQV 4N/2 RD	32 A 60	2460450000
ZQV 4N/10 RD	32 A 20	2460740000
ZQV 4N/2 BL	32 A 60	1528040000
ZQV 4N/10 BL	32 A 20	1528230000
AEP AP21	20	2429020000
AEB 35 SC/1	50	1991920000
ZEW 35/2	20	8630740000
ATPG 1.5-10 L	0.2 A 50	1991890000
PS 2.0 MC	20	0310000000
SDIL 0,6X3,5X100	1	2749140000
WS 10/6 M PLUS MC NE WS	600	2003780000
DEK 5/6 MM WS	600	2007120000
DEK 5/6 PLUS MC NE WS	1000	1011320000
WS 8/6 MM WS	600	2007160000

**Control voltage distribution
PUSH IN connection**

AAP – potential distribution terminal blocks



Width/Height/Depth	mm
max. current / max. cond. cross-section	A/mm ²
Max. clamping range	mm ²

Technical data

Rated data	
Rated voltage	V
Rated current	A
for wire cross-section	mm ²
Rated impulse withstand voltage / Pollution severity	
UL 94 flammability rating	
Approvals	
Clamped conductors (H05V/H07V)	
Solid / Stranded	mm ²
Flexible / Flexible with ferrule	mm ²
Stripping length	
Blade size	

Note

Ordering data

Version	
beige / red pusher, 250 V AC/DC, without LED	
beige / red pusher, 10-36 V AC/DC, with LED	
beige / red pusher, 30-70 V AC/DC, with LED	
beige / red pusher, 60-150 V AC/DC, with LED	
beige / red pusher, 100-250 V AC/DC, with LED	
beige / orange pusher, 250 V AC/DC, without LED	
beige / orange pusher, 100-250 V AC/DC, with LED	
beige / blue pusher	
beige / orange pusher	
blue / orange pusher	

Note

Accessories

Plug-in cross-connection	
	2-pole/ red
	10-pole / red
	2-pole / blue
	10-pole/ blue
End plate / Partition plate	
End bracket	
	dark beige, screwable
	dark beige, direct mounting
Test plug	
Screwdriver	
	Standard
Marking tags	
G-fuse cartridge, 5 x 20 mm (IEC 60127-2)	
	0.25 A fast
	0.50 A fast
	1.00 A fast
	2.00 A fast
For detailed information on other accessories and application in the online catalogue	

AAP21 4 FS

4 mm²

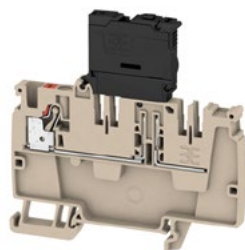

6.1 x 82 x 82
6.3 / 4
0.14...4

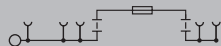

Ex ec II C Gc II
In accordance with IEC 60947-7-3 2 G D

IEC	UL	CSA	EN 60079-7
250	150 (C)		
6.3	10		6.3
4	AWG 26...10		4 mm ²
4 kV / 3			
V-0			

TUEV17ATEX8064U

Rated connection		
0.5...4 / 0.5...4		
0.5...4 / 0.5...4		
12 mm		
0.6 x 3.5 mm		

Type	Qty.	Order No.
AAP21 4 FS	50	2428950000
AAP21 4 FS 10-36V	50	2458990000
AAP21 4 FS 30-70V	50	2460200000
AAP21 4 FS 60-150V	50	2460190000
AAP21 4 FS 100-250V	50	2460180000
AAP21 4 FS OR	50	2581720000
AAP21 4 FS 100-250V OR	50	2581790000

Type	Qty.	Order No.
ZQV 4N/2 RD	32 A 60	2460450000
ZQV 4N/10 RD	32 A 20	2460740000
AEP AP21		
AEP AP21	20	2429020000
AEB 35 SC/1		
AEB 35 SC/1	50	1991920000
AEB 35 SCL/1 V0	20	2661280000
PS 2.0 MC		
PS 2.0 MC	20	0310000000
SDIL 0,6X3,5X100		
SDIL 0,6X3,5X100	1	2749140000
WS 10/6 M PLUS MC NE WS		
WS 10/6 M PLUS MC NE WS	600	2003780000
DEK 5/6 MM WS		
DEK 5/6 MM WS	600	2007120000
WS 8/6 MM WS		
WS 8/6 MM WS	600	2007160000
DEK 5/6 PLUS MC NE WS		
DEK 5/6 PLUS MC NE WS	1000	1011320000
G 20/0.25A/F		
G 20/0.25A/F	0.25 A 10	0430500000
G 20/0.50A/F		
G 20/0.50A/F	0.5 A 10	0430600000
G 20/1.00A/F		
G 20/1.00A/F	1 A 10	0430700000
G 20/2.00A/F		
G 20/2.00A/F	2 A 10	0430900000

AAP21 4 DT

4 mm²

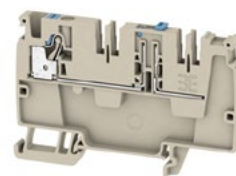

6.1 x 82 x 55
20 / 4
0.14...4



Ex ec II C Gc II
In accordance with IEC 60947-7-1 2 G D

IEC	UL	CSA	EN 60079-7
250	150 (C)	150 (C)	
20	20	20	19
4	AWG 26...10	AWG 26...10	4 mm ²
4 kV / 3			
V-0			

TUEV16ATEX7939U

Rated connection		
0.5...4 / 0.5...4		
0.5...4 / 0.5...4		
12 mm		
0.6 x 3.5 mm		

Type	Qty.	Order No.
AAP21 4 DT	50	2428980000
AAP21 4 DT OR	50	2581710000
AAP21 4 DT BL/OR	50	2582520000

Type	Qty.	Order No.
ZQV 4N/2 BL	32 A 60	1528040000
ZQV 4N/10 BL	32 A 20	1528230000
AEP AP21		
AEP AP21	20	2429020000
AEB 35 SC/1		
AEB 35 SC/1	50	1991920000
AEB 35 SCL/1 V0	20	2661280000
SDIL 0,6X3,5X100		
SDIL 0,6X3,5X100	1	2749140000
WS 10/6 M PLUS MC NE WS		
WS 10/6 M PLUS MC NE WS	600	2003780000
DEK 5/6 MM WS		
DEK 5/6 MM WS	600	2007120000
WS 8/6 MM WS		
WS 8/6 MM WS	600	2007160000
DEK 5/6 PLUS MC NE WS		
DEK 5/6 PLUS MC NE WS	1000	1011320000



Clear, compact construction of control voltage distribution

Example configuration of potential distribution terminal block with fusing

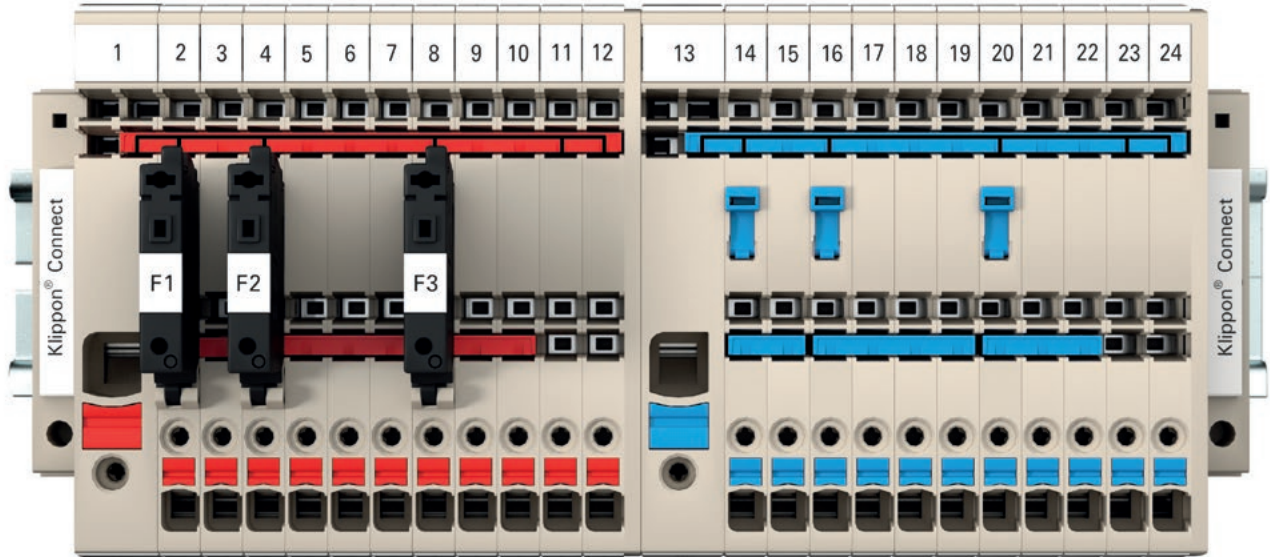

- Group fusing through breakaway of individual poles in the cross-connections
- Groups can be switched potential-free via a disconnecter
- Direct potential distribution possible without fusing within the structure

Schematic representation of circuit diagram

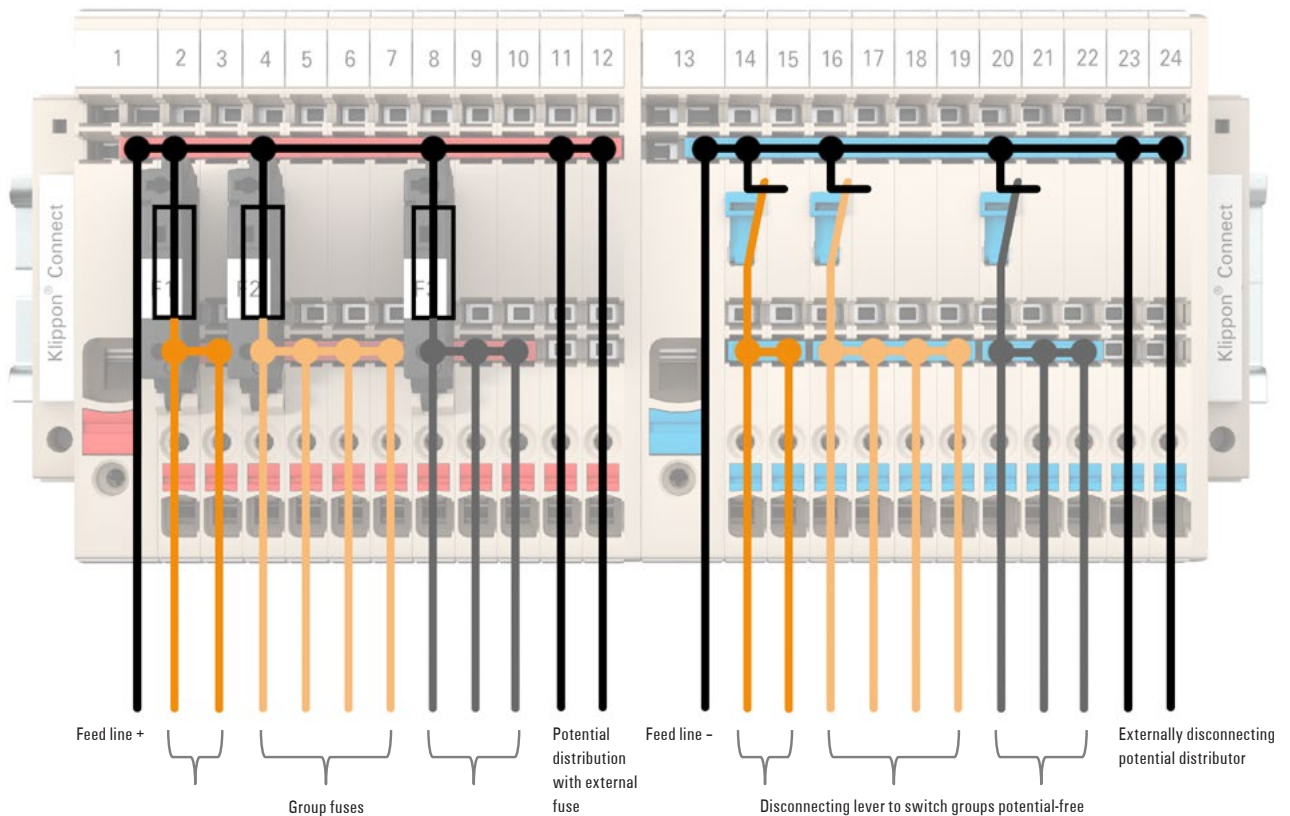

Control voltage distribution PUSH IN connection

AAP - potential distribution terminal blocks

Potential distribution with integrated fusing



Width/Height/Depth	mm
max. current / max. cond. cross-section	A/mm ²
Max. clamping range	mm ²

Technical data

Rated data	
Rated voltage	V
Rated current	A
for wire cross-section	mm ²
Rated impulse withstand voltage / Pollution severity	
Gauge to IEC 60947-1 / UL 94 flammability rating	
Number of operating cycles	
Approvals	
Clamped conductors (H05V/H07V)	
Solid / Stranded	mm ²
Flexible / Flexible with ferrule	mm ²
Stripping length / Blade size	mm/-

Note

Ordering data

Version	
	beige / red and blue pusher
Note	

Accessories

Plug-in cross-connection	
	2-pole/ red
	10-pole / red
	2-pole / blue
	10-pole/ blue
End plate / Partition plate	
End bracket	
	dark beige, screwable
	dark beige, direct mounting
Test plug	
Screwdriver	
	Standard
Marking tags	

For detailed information on other accessories and application in the online catalogue

AAP22 10 LO-LO

10 mm²

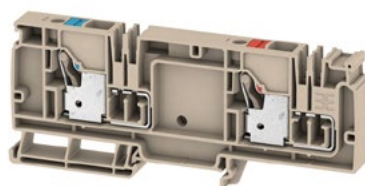

12 x 129 x 53.5	
57 / 10	
0.5...10	

In accordance with IEC 60947-7-1

IEC	UL	CSA	EN 60079-7
250	150	150	
57	51	51	
10	AWG 20...6	AWG 20...6	
4 kV / 3			
A6 / V-0			

© CE ENEC

Rated connection	
0.5...10 / 0.5...10	
0.5...10 / 0.5...10	
18 / 1.0 x 5.5 mm	

Type	Qty.	Order No.
AAP22 10 LO-LO	20	2428990000

Type	Qty.	Order No.
ZQV 4N/2 RD	32 A 60	2460450000
ZQV 4N/10 RD	32 A 20	2460740000
ZQV 4N/2 BL	32 A 60	1528040000
ZQV 4N/10 BL	32 A 20	1528230000
AEP AP22	20	2429040000
AEB 35 SC/1	50	1991920000
AEB 35 SCL/1 V0	20	2661280000
PS 2.0 MC	20	0310000000
SDIL 1,0X5,5X125	1	2749160000
DEK 5/5 PLUS MC NE WS	1000	1854490000
DEK 5/8 PLUS MC NE WS	800	1046350000
WS 10/8 PLUS MC NE WS	420	1905950000

AAP22 10 FE-LO

10 mm²

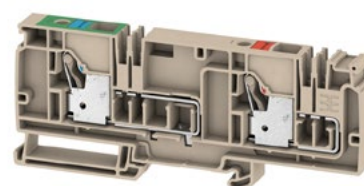

12 x 129 x 53.5	
17 / 10	
0.5...10	

In accordance with IEC 60947-7-2

IEC	UL	CSA	EN 60079-7
250	150	150	
57	51	51	
10	AWG 20...6	AWG 20...6	
4 kV / 3			
A6 / V-0			

© CE ENEC

Rated connection	
0.5...10 / 0.5...10	
0.5...10 / 0.5...10	
18 / 1.0 x 5.5 mm	

Type	Qty.	Order No.
AAP22 10 FE-LO	20	2429000000

Type	Qty.	Order No.
ZQV 4N/2 RD	32 A 60	2460450000
ZQV 4N/10 RD	32 A 20	2460740000
ZQV 4N/2 BL	32 A 60	1528040000
ZQV 4N/10 BL	32 A 20	1528230000
AEP AP22	20	2429040000
AEB 35 SC/1	50	1991920000
AEB 35 SCL/1 V0	20	2661280000
PS 2.0 MC	20	0310000000
SDIL 1,0X5,5X125	1	2749160000
DEK 5/5 PLUS MC NE WS	1000	1854490000
DEK 5/8 PLUS MC NE WS	800	1046350000
WS 10/8 PLUS MC NE WS	420	1905950000

For detailed information on other accessories and application in the online catalogue



AAP - potential distribution terminal blocks

AAP22 4 LI-FS

4 mm²

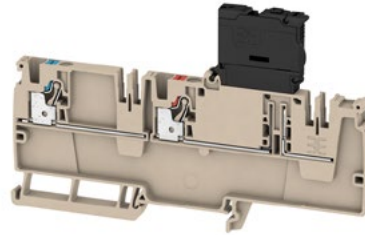

Width/Height/Depth	mm
max. current / max. cond. cross-section	A/mm ²
Max. clamping range	mm ²

6.1 x 129 x 82
6.3 / 4
0.14...4

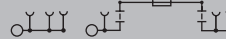

Technical data

Rated data	
Rated voltage to adjoining terminal	V
Rated current	A
for wire cross-section	mm ²
Rated impulse withstand voltage / Pollution severity	
UL 94 flammability rating	
Approvals	
Clamped conductors (H05V/H07V)	
Solid / Stranded	mm ²
Flexible / Flexible with ferrule	mm ²
Stripping length	
Blade size	

In accordance with IEC 60947-7-1, Ex ec II C Gc II
In accordance with IEC 60947-7-3 2 G D

IEC	UL	CSA	EN 60079-7
500	300 (D)		
6.3	10		6.3
4	AWG 26...10		4 mm ²
4 kV / 3			
V-0			

TUEV17ATEX8064U

Rated connection	
0.5...4 / 0.5...4	
0.5...4 / 0.5...4	
12 mm	
0.6 x 3.5 mm	

Note

Ordering data

Version	
	250 V AC/DC, without LED
	10-36 V AC/DC, with LED
	30-70 V AC/DC, with LED
	60-150 V AC/DC, with LED
	100 - 250 V AC/DC, with LED
Note	

Type	Qty.	Order No.
AAP22 4 LI-FS	50	2429010000
AAP22 4 LI-FS 10-36V	50	2459010000
AAP22 4 LI-FS 30-70V	50	2460140000
AAP22 4 LI-FS 60-150V	50	2460130000
AAP22 4 LI-FS 100-250V	50	2460120000

Accessories

Plug-in cross-connection	
	2-pole / blue
	10-pole/ blue
	2-pole/ red
	10-pole / red
End plate / Partition plate	
End bracket	
	dark beige, screwable
	dark beige, direct mounting
Screwdriver	
	Standard
Marking tags	

Type	Qty.	Order No.
ZQV 4N/2 BL	32 A 60	1528040000
ZQV 4N/10 BL	32 A 20	1528230000
ZQV 4N/2 RD	32 A 60	2460450000
ZQV 4N/10 RD	32 A 20	2460740000

AEP AP22	20	2429040000
AEB 35 SC/1	50	1991920000
AEB 35 SCL/1 VO	20	2661280000
SDIL 0,6X3,5X100	1	2749140000
WS 10/6 M PLUS MC NE WS	600	2003780000
DEK 5/6 MM WS	600	2007120000
WS 8/6 MM WS	600	2007160000
DEK 5/6 PLUS MC NE WS	1000	1011320000

G-fuse cartridge, 5 x 20 mm (IEC 60127-2)	
	0.25 A fast
	0.50 A fast
	1.00 A fast
	2.00 A fast

G 20/0.25A/F	0.25 A	10	0430500000
G 20/0.50A/F	0.5 A	10	0430600000
G 20/1.00A/F	1 A	10	0430700000
G 20/2.00A/F	2 A	10	0430900000

For detailed information on other accessories and application in the online catalogue



Control current distribution further developed

Load monitoring and potential distribution in one overall solution

New ways in the control current distribution increase the efficiency in the operation of machines and plants. The combination of load monitoring and potential distribution terminals saves up to 50 % space and up to 20 % wiring costs, while the free combinability of numerous single-channel and four-channel variants optimizes material costs. Benefit from the advantages of a modular system that offers you high flexibility and adapts optimally to any application.



B

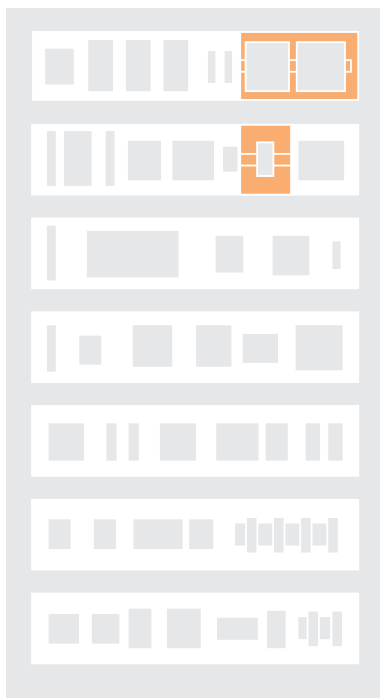

Combination of load monitoring and potential distribution

Electronic load monitoring

Current bar: 40 A - plus
 internal signal line
 output - plus
 output - minus
 Current bar: 40 A - minus
 6.1 mm

Potential distribution terminal

- Three main connection channels: positive, negative and internal signals
- Simple to increase the number of contacts thanks to crossconnection option in the potential distribution terminals

Intelligent protection of DC loads

topGUARD load monitoring system with communication via IO-LINK

Modern machines and plants require load monitoring systems capable of communication. The IO-Link-capable load monitoring system topGUARD offers remote control options, full data transparency, and reliable protection of the 24 V system voltage.

topGUARD is an outstanding supplement to the IO-LINK-capable PROtop power supplies for innovative power management systems. It saves space and time during device installation through an innovative approach to integrated distribution of potential. Parameterisation, control, and provision of all operating data are carried out by plugging in the IO-Link module and integrating an IODD file. The module can be used for PROtop power supplies as well as for topGUARD load monitoring.

IO-LINK capable

The IO-Link-capable load monitoring system topGUARD offers remote control options, provides operating data for optimal condition monitoring, and enables entirely new control solutions.

Data transparency and remote control thanks to IO-Link.

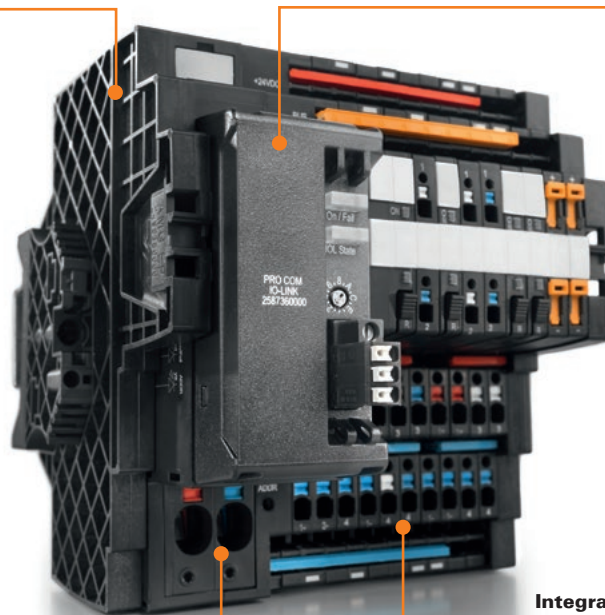

Modular and innovative

The modular concept enables custom-fit solutions. The first of its kind, voltage-adaptive class 2 load monitoring allows the continued use of 18 to 30 V DC operating voltage.

Integrated distribution of potential

The integrated distribution of potential, well known from the maxGUARD concept, takes up significantly less space and saves valuable time during installation.



Load monitoring and potential distribution in one complete solution

maxGUARD – taking control voltage distribution to a new level

Fail-safe and maintenance-friendly control voltage distributions that can be installed in a time- and space-saving manner are a must for efficient machine and facility operation. With the new maxGUARD system, the terminal blocks (previously installed separately) for distributing potential to the outputs of the electronic load monitors become an integral part of a 24 V DC control voltage distribution solution. The new combination of load monitoring and potential distribution saves time during installation, increases safety against failure and reduces the amount of space required on the terminal rail by 50 %.



Extreme ease of servicing

Sophisticated operating, testing and connection elements permit safe access to all voltage potentials and load circuits during commissioning and maintenance.

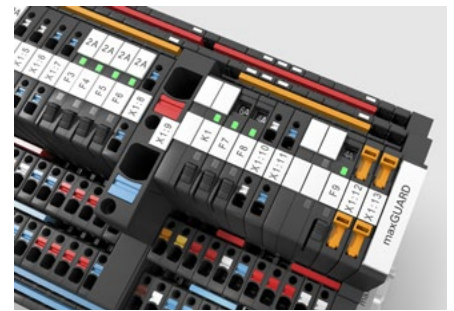

IECEX

B

Sophisticated arrangement of connections and markers ensures clarity

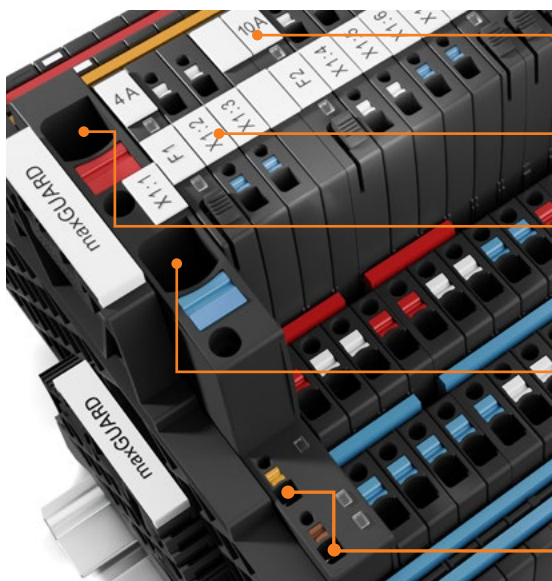

Markers for current strength

Continuous marker channel for equipment ID

Supply terminal (positive): 16 mm²

Supply terminal (negative): 16 mm²

Reset input and alarm output for connecting to the PLC

now up to
70°C
usable

Integrated test point

Consistently integrated test points in the maxGUARD control voltage distribution's input and output speed up troubleshooting operations.

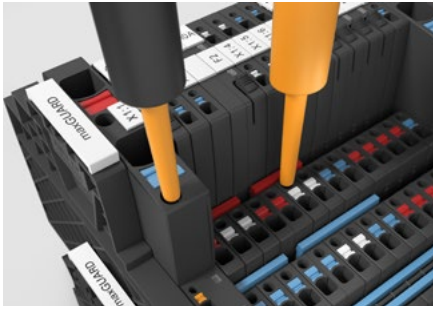

Practical disconnecting lever

Potential distributor with a disconnecting lever for simple galvanic isolation of the load circuit for testing and checking purposes.

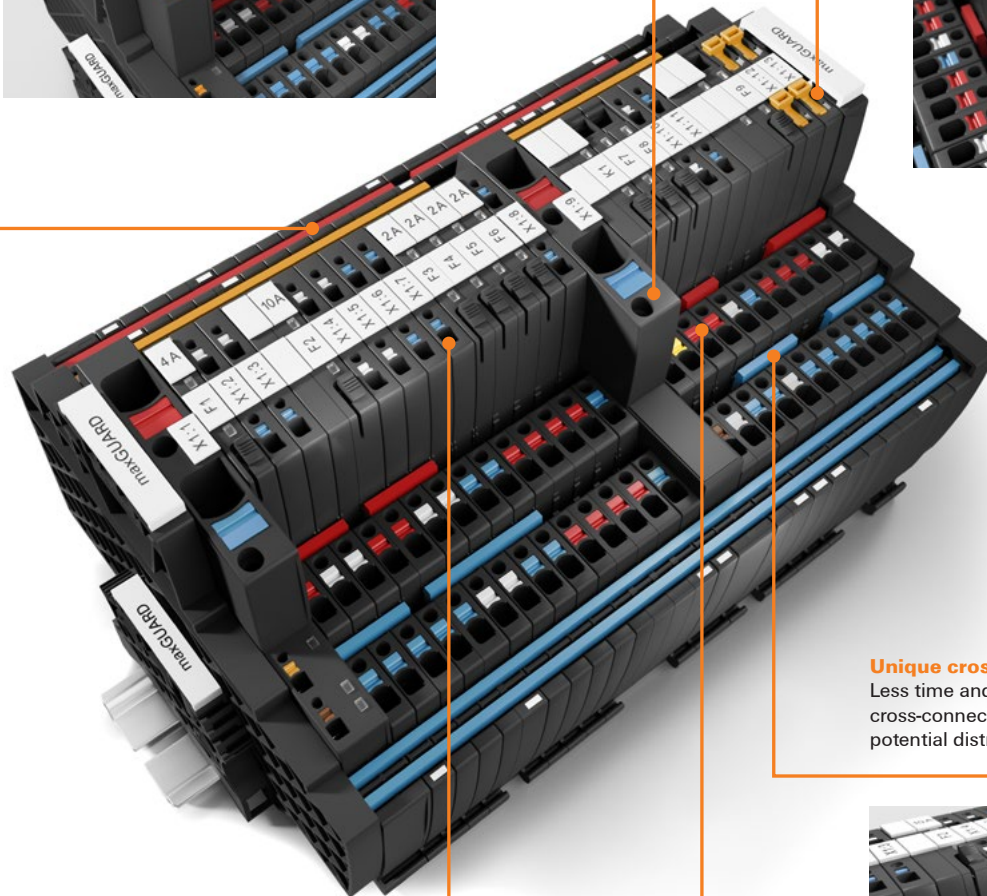

B

Unique cross-connectors

Less time and effort needed for wiring due to cross-connections between load monitoring and potential distribution terminals.



Time saving
of up to
20%

Particularly space-saving

Electronic load monitors and potential distributors with a 6.1 mm pitch.

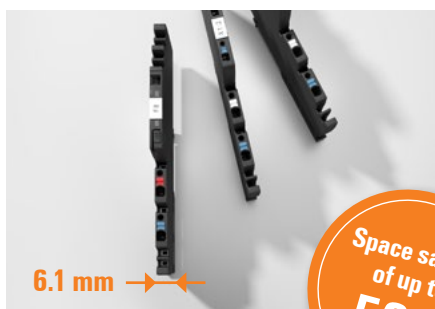

6.1 mm

Space saving
of up to
50%

Can be used in a customised way

The sheer range of variants and the very different potential distribution terminals and additional components enable customised solutions at all times.





maxGUARD – product overview

Flexible and modular design

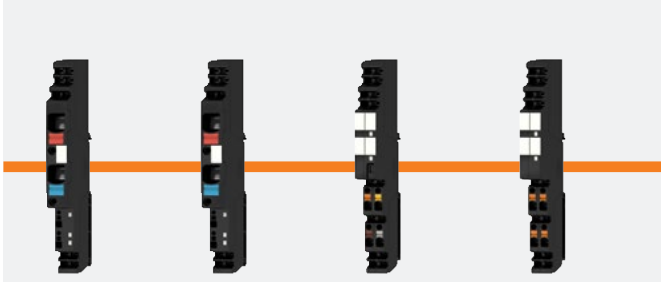

Supply terminals, control and alarm modules

Electronic load monitoring



 Supply terminal 16 mm² Passive	 Supply terminal 16 mm² With alarm and reset function	 Control module Alarm Reset >90 % ON/OFF	 Alarm module Potential-free contacts for alarm >90 %
---	--	--	---



 Fixed-value modules 1 / 2 / 4 / 6 A 6.1 mm housing 8 A / 10 A 12.2 mm housing	 Adjustable module 1 - 2 - 3 - 4 - 6 A 6,1 mm housing 4 - 6 - 8 - 10 - 12 A 12,2 mm housing 10 - 12 - 14 - 16 - 18 A 12,2 mm housing	 Adjustable module 0,1...1A 6,1 mm housing with current limiting function
--	--	--

B



Power-feed, control and alarm module

Alarm module with potential-free contacts for the "Alarm" and "I > 90%" signals. Control module with extended control function. Passive or active power-feed module with reset and alarm function

Load monitoring (fixed value)

Electronic load monitoring with fixed current (without I > 90% function)

Load monitoring adjustable

Electronic load monitoring with adjustable triggering current and triggering characteristic (with I > 90% function)

Load monitoring adjustable

Load monitoring device with adjustable tripping current und current limiting function (with I > 90% function)

Type	Order No.
AMG FIM-O	2081870000
AMG FIM-C	2081880000
AMG FIM-O EX	2082530000
AMG FIM-C EX	2082540000
AMG CM	2081900000
AMG CM EX	2083360000
AMG AM	2081890000
AMG AM CO	2082770000

Type	Order No.
AMG ELM-1F	2080420000
AMG ELM-1F EX	2082040000
AMG ELM-2F	2080480000
AMG ELM-2F EX	2082050000
AMG ELM-4F	2080490000
AMG ELM-4F EX	2082060000
AMG ELM-6F	2080500000
AMG ELM-6F EX	2082310000
AMG ELM-8F	2080600000
AMG ELM-8F EX	2082320000
AMG ELM-10F	2080650000
AMG ELM-10F EX	2082430000

Type	Order No.
AMG ELM-6	2080360000
AMG ELM-6 EX	2082000000
AMG ELM-12	2080410000
AMG ELM-12 EX	2082010000
AMG ELM-18	2859800000
AMG ELM-18 EX	2838520000

Type	Order No.
AMG ELM-1 LIM CL2 EX	2838530000

Potential distribution and accessories

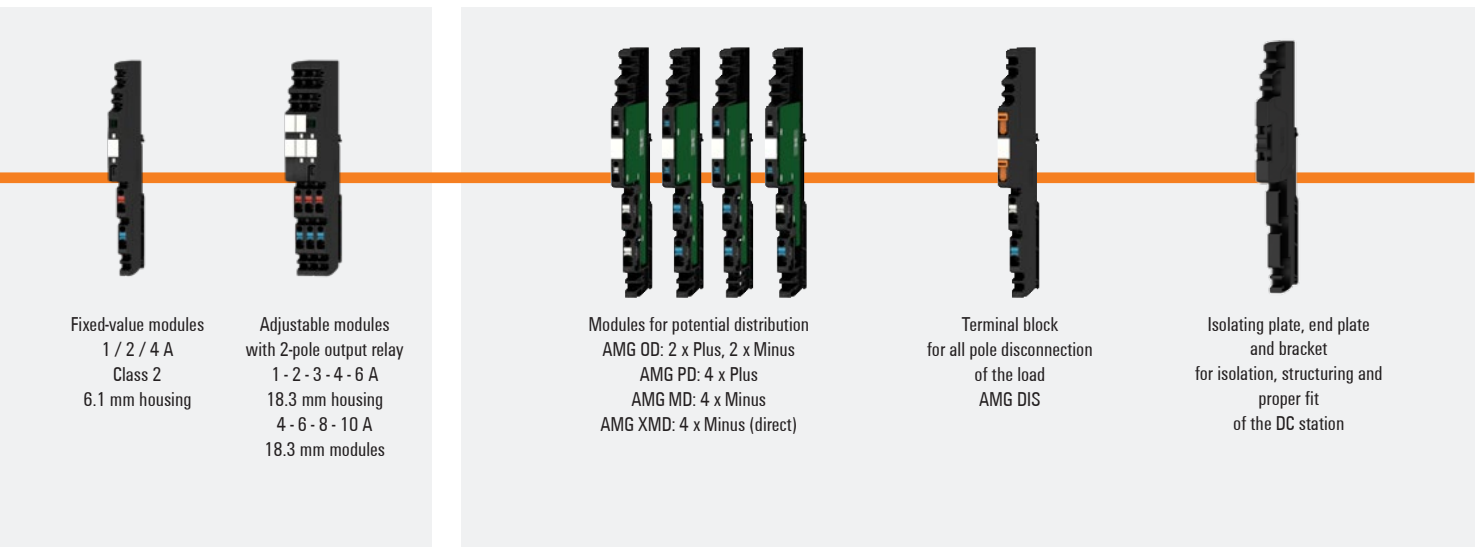

Fixed-value modules
1 / 2 / 4 A
Class 2
6.1 mm housing

Adjustable modules
with 2-pole output relay
1 - 2 - 3 - 4 - 6 A
18.3 mm housing
4 - 6 - 8 - 10 A
18.3 mm modules

Modules for potential distribution
AMG OD: 2 x Plus, 2 x Minus
AMG PD: 4 x Plus
AMG MD: 4 x Minus
AMG XMD: 4 x Minus (direct)

Terminal block
for all pole disconnection
of the load
AMG DIS

Isolating plate, end plate
and bracket
for isolation, structuring and
proper fit
of the DC station

B

Load monitoring (fixed value) Class 2

Electronic load monitoring with fixed rated current
(without I > 90 % pre warning)
Class 2 Approval

Type	Order No.
AMG ELM-1F CL2	2491270000
AMG ELM-2F CL2	2491280000
AMG ELM-4F CL2	2491290000

Load monitoring with relay

Electronic load monitoring with 2-pole output relay for allpole load disconnection; triggering current and triggering characteristic adjustable
(with I > 90 % function)

Type	Order No.
AMG ELM-6D CO	2082440000
AMG ELM-10D CO	2082470000

Potential distributor

Flexible application through various potential distributor.

Type	Order No.
AMG MD	2122930000
AMG MD EX	2495040000
AMG OD	2122910000
AMG OD EX	2495090000
AMG PD	2122920000
AMG PD EX	2495070000
AMG XMD	2122940000
AMG XMD EX	2495080000
AMG DIS	2123050000
AMG DIS EX	2495100000

End plate and Separation plate

End plate for mechanical stabilization.
Separation plate for logical subdivision.

Type	Order No.
AMG PP	2123000000
AMG EP	2495380000
AMG EP KIT	2500760000

Efficient implementation of testing and measurement switchgear

Safe and thorough with Klippon® Connect

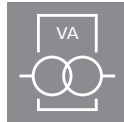

In energy monitoring, incorrect wiring can destroy current and voltage transformers. Our specially developed test-disconnect terminal blocks, in various connection technologies, are a safe way of solving this problem. Simple operation ensures error-free, convenient wiring. This guarantees the protection of your transformers and measuring devices and ensures safe, precise work. Our integrated terminal blocks, in modular design for transformer switches, also save space in the panel.

Our promise

The sophisticated features and proven connection technologies means Klippon® Connect solves testing and measurement issues more safely and efficient. Our extensive portfolio provides flexibility and productivity at all stages of the process.

B

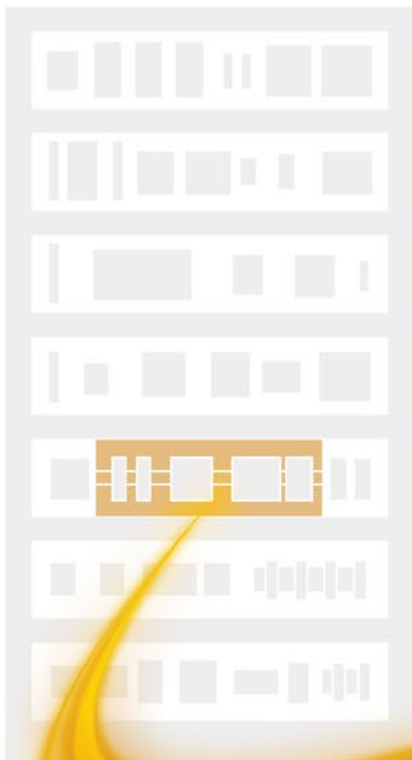

Safety

- Highest possible protection of measuring instruments against destruction by avoiding incorrect wiring
- Safe protection of connected power converters thanks to integrated short-circuit contact
- Simple, safe operation thanks to clear identification of switch status
- Lockout to secure the relevant switching status

Space saving

- Modular setup of transformer switching thanks to test-disconnect terminal blocks
- Design of a simple current transformer test circuit with just two terminal blocks

Time saving

- Extensive range of accessories consisting of test adapters, cross-connections and markers
- PUSH IN technology for quick, safe wiring
- Make before breake function exclusive to the TTB family

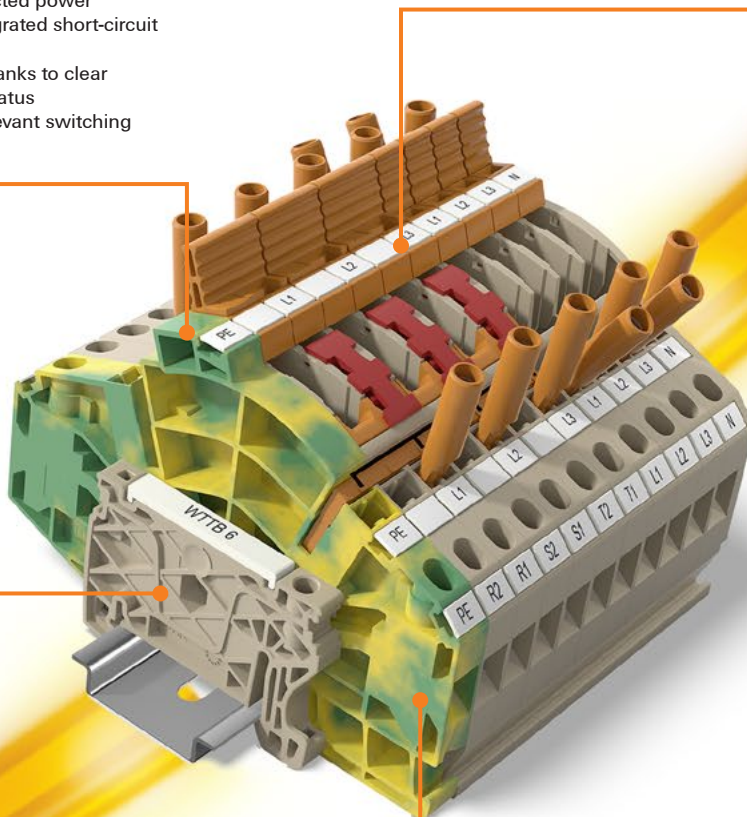

Flexibility

- Reliable implementation of all standard transformer switching applications
- Specially developed for all conceivable requirements



Our range



Simple operation to prevent errors:

With our test-disconnect terminal blocks, based on tested Weidmüller screw connection technology, connecting challenges can be resolved clearly and cost-effectively. The screws connecting the conductors are only accessible after the current transformer has been short-circuited using the short-circuit slider. This ensures safety as it prevents accidental short-circuiting or opening of the converter circuit.



Screwless and simple:

Our test-disconnect terminal blocks with PUSH IN and tension clamp technology are the ideal solution to establishing switching circuits for measurement tasks. The simple operating system with a spring connection and the clear identification of the switch status guarantee safe short-circuiting and disconnecting at all times.

Klippon® Connect TTB Range for instrument transformer wiring

Ensuring safety of personnel and devices

In T&D applications, current and voltage transformers are mainly used for protection and measurement functions. Our new TTB range of Klippon® Connect instrument transformer terminal blocks have been designed to meet all the connection requirements of these two critical applications.



The wiring of current and voltage transformers can be carried out particularly easily and safely with the new terminal block series – even within complex circuits. The prevention of operating errors during operation increases plant availability and extends the life cycle of the entire control cabinet. Thus, the respective requirements of the end user are fulfilled to the highest degree.

B



Captive components

All function- and safety-relevant components are captively connected to the terminal block. This increases the reliability of the current and voltage transformer circuits during installation and maintenance work.

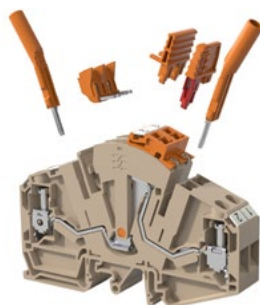

Data-supported accessory selection via WMC

The complete provision of data in the Weidmüller Configurator (WMC) enables a particularly simple selection of safety-critical accessories as well as safe and rational product configuration.

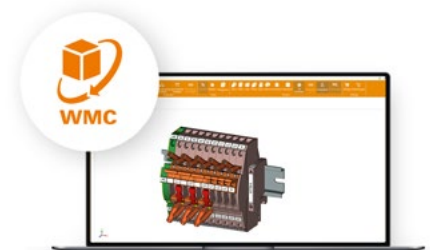

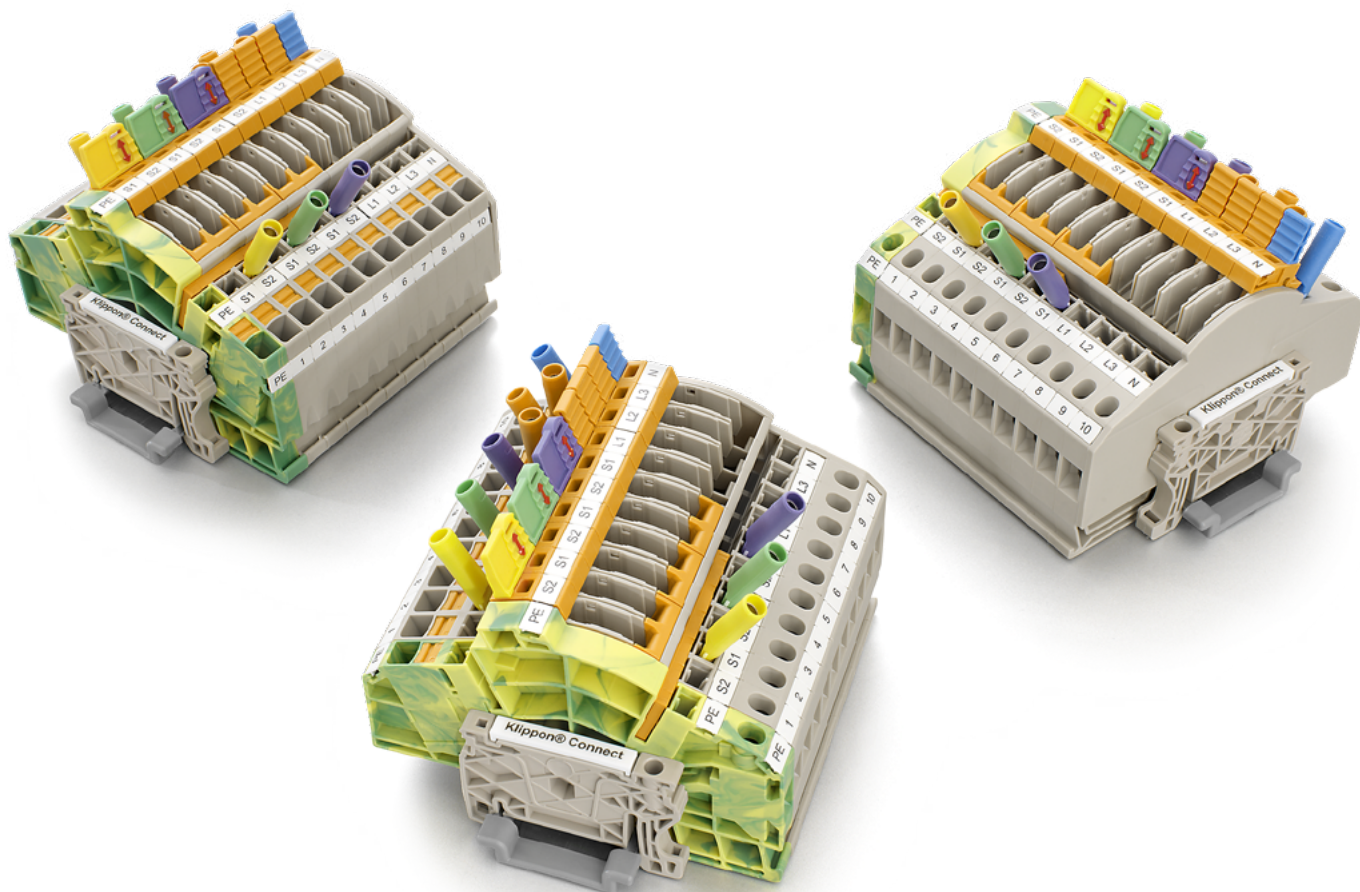

B

Unique lever mechanism

The unique lever mechanism is particularly user-friendly. It offers maximum contact reliability and can be optimally operated under all lighting conditions. The disconnect lever can be operated either manually or with a standard screwdriver. It also offers an easy possibility to implement multi-pole actuations.

Free choice of connection technology

The TTB range terminal blocks and their accessories are highly standardised. All features can be used regardless of the chosen connection solution – whether PUSH IN or screw connection.

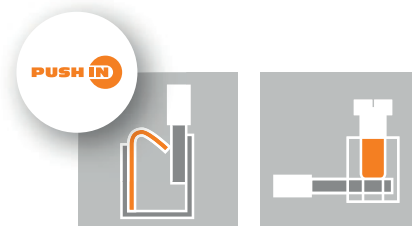

Unique features giving added value throughout the complete process

From planning through installation and operation

Data-supported accessory selection via WMC

The complete provision of data in the Weidmüller Configurator (WMC) enables a particularly simple selection of safety-critical accessories as well as safe and rational product configuration.

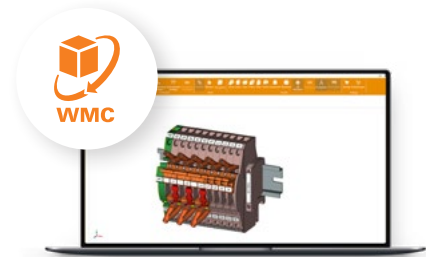

B

Free choice of connection technology

The TTB range terminal blocks and their accessories are highly standardised. All features can be used regardless of the chosen connection solution – whether PUSH IN or screw connection.

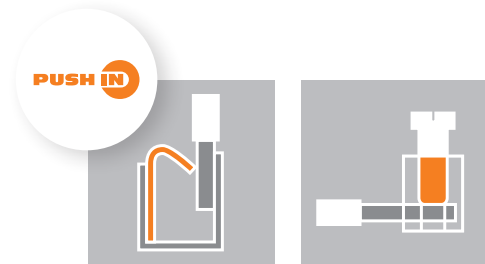

Maximum function density

The new transformer terminal blocks of the TTB range are particularly compact and offer an outstanding functional density compared to other solutions on the market.

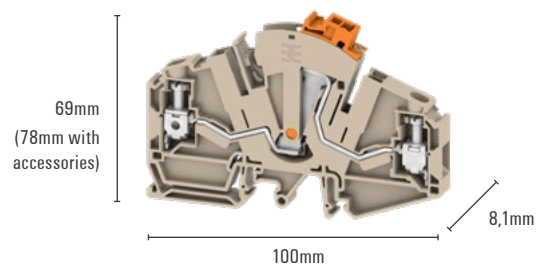

PE terminal with identical contour

The new TTB range includes a PE terminal block having the same contour. It can be connected to the current or voltage transformer terminal via standard cross-connections. This simplifies and accelerates the earthing of star points in the control cabinet.

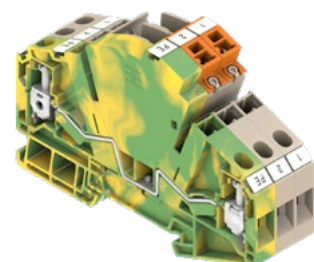

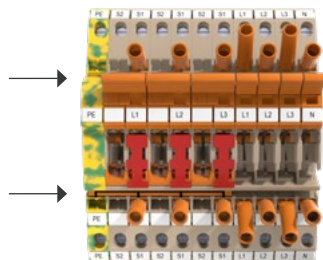

Dedicated cross-connection channel

A cross-connection channel, upstream and downstream the disconnect point, ensures maximum flexibility during installation. Neither the short-circuit function of current transformers nor the testing possibilities are limited. In this way, even more complex circuit requirements can be realised with the same standardised accessories.

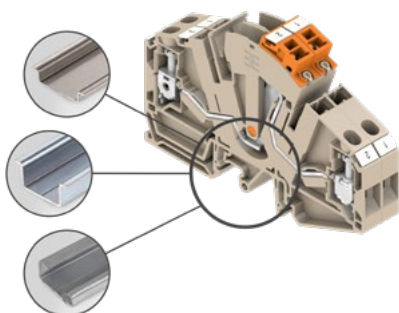

Easy to install (for WTTB 6 and HTTB 6)

The integrated combi-foot simplifies flexible mounting on the common G32 and TH35 mounting rail profiles. The product replacement therefore can be carried out without the cost-intensive exchange of the mounting rails.



Unique lever mechanism

The unique lever mechanism is particularly user-friendly. It offers maximum contact reliability and can be optimally operated under all lighting conditions. The disconnect lever can be operated either manually or with a standard screwdriver. It also offers an easy possibility to implement multi-pole actuations.

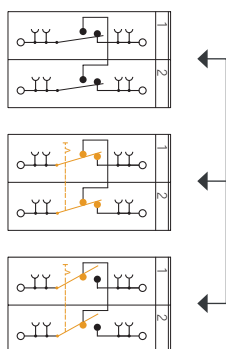

New forced short circuit functionality

The combination of isolating lever, short circuit bridge, and lever link in a single system guarantees that the secondary wiring of a current transformer is short-circuited before the longitudinal disconnection takes place. This „Make Before Break“ contact can be realised for up to four terminals.



Unique features giving added value throughout the complete process From planning through installation and operation

Reliable comparative measurement

A patented CM (Comparative Measurement) lever link allows two terminal blocks to be selectively separated to connect a calibrated measuring device. After the measurement, the captive lever is returned to its original position, with the „make before break“ contact remaining active. This is a unique feature of the TTB range which guarantees maximum safety for personnel and asset preservation.

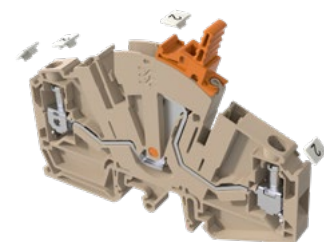
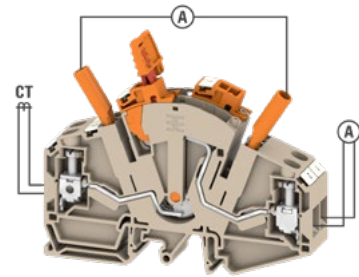

Clear marking

To identify circuits unambiguously is extremely important for safety. For this reason, the new instrument transformer terminal blocks have large marking areas which are clearly visible from any angle.

Angled test sockets

The angled test sockets enable the connection of 4.0 plugs in widths of up to 10 mm. Due to the alternating arrangement, all standard measurements can be done without fanning-out despite the reduced width of the terminal.

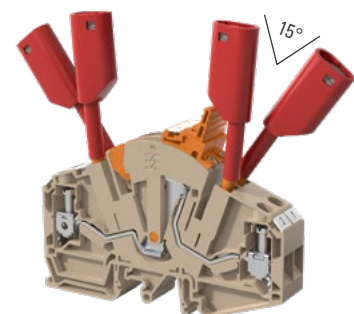

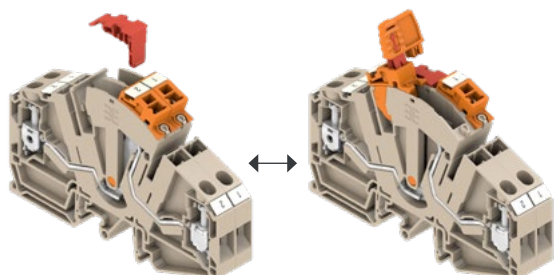

Reliable switch lock

The switch lock prevents the disconnect lever from being moved out of the set position. This avoids unauthorised opening and closing of circuits.

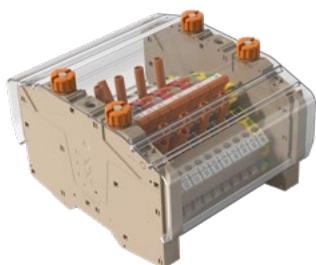

Enhanced safety cover hood system

The transparent cover hood system protects and seals the entire assembly. It is available either as a full-length profile or as an individual cover. It can only be fixed when all connection components are in their initial position. The assembly is optimally protected against unauthorised access without impairing visual inspection.

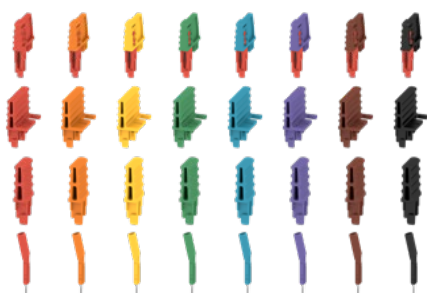

Distinct colour coding

In order to guarantee maximum safety in installation and maintenance, an extensive colour range is available for the requested colour-coding of terminals, accessories, test sockets and lever links.



IEC CB Scheme Certification

Klippon® Connect TTB range instrument transformer terminal blocks are certified by third party according to the requirements of IEC 60947-7-1 – Annex D Standard. Such certification grants the safe use of TTB range terminals throughout time and is a recognised qualified reference worldwide.



Klippon® Connect TTB-Range

Technical details and order numbers

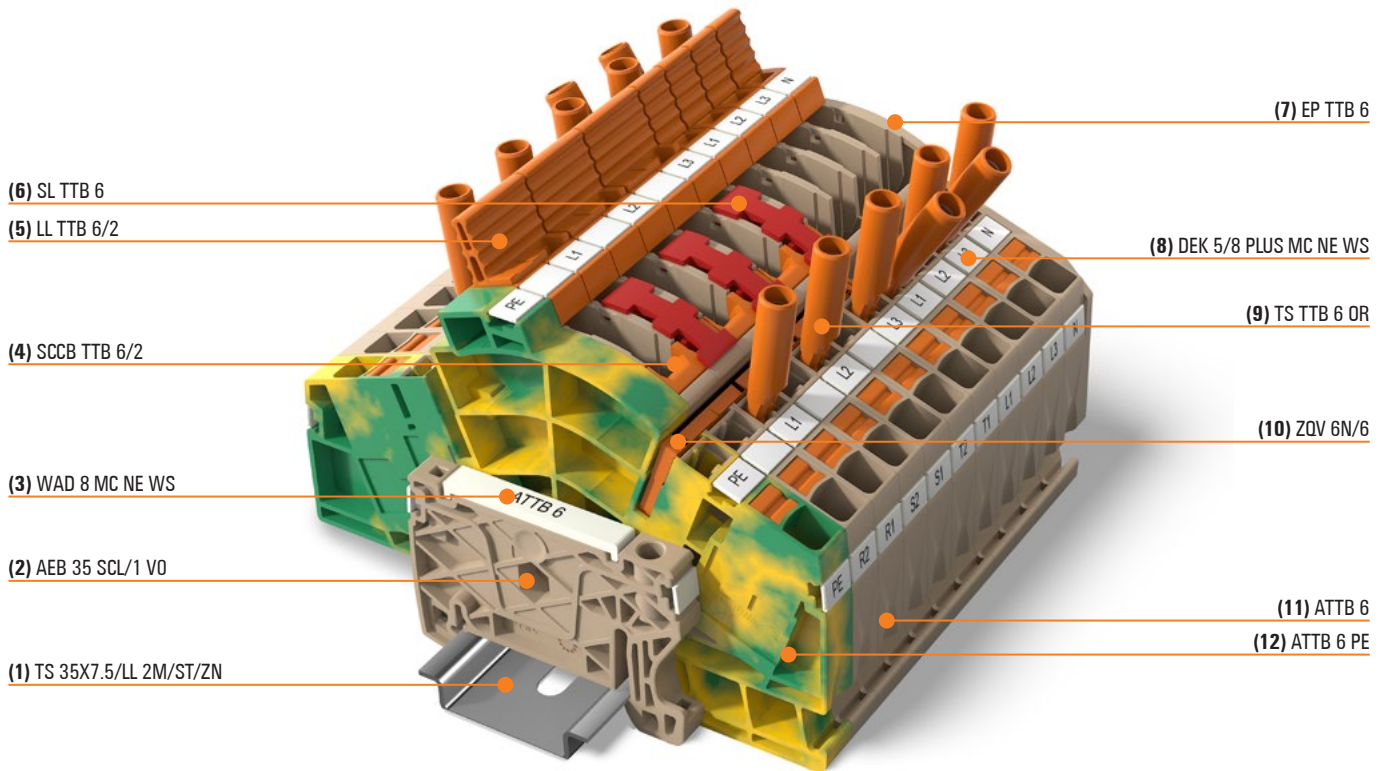

Overview of ordering data

Pos.	Description	Type	Dimensions	Color	Qty.	Order No.
1	Mounting rail	TS 35X7.5/LL 2M/ST/ZN	35 x 7.5 x 2000 mm	silver	2	0514500000
2	End bracket	AEB 35 SCL/1 V0	6 x 52.6 x 36.5 mm	dark beige*	50	2661280000
3	Group marker	WAD 5 MC NE WS	6 x 11.7 x 33.3 mm	white	48	1112910000
4	Short circuit bridge	SCCB TTB 6/2	16 x 13.5 x 14 mm	orange*	25	2710190000
	Short circuit bridge	SCCB TTB 6/3	24 x 13.5 x 14 mm	orange*	25	2710200000
	Short circuit bridge	SCCB TTB 6/4	32 x 13.5 x 14 mm	orange*	25	2710210000
5	Lever link	LL TTB 6/1	7.6 x 19.7 x 4 mm	orange*	50	2710230000
	Lever link	LL TTB 6/2	15.7 x 19.7 x 8.2 mm	orange*	50	2710300000
	Lever link	LL TTB 6/3	23.8 x 19.7 x 8.2 mm	orange	10	2710440000
	Lever link	LL TTB 6/4	31.9 x 19.7 x 8.2 mm	orange	10	2710450000
	Lever link	LL TTB 6/6	48.1 x 19.7 x 8.2 mm	orange	10	2710460000
	Lever link for comparative measurement	LL TTB 6/2 CM	15.9 x 25.1 x 4.2 mm	orange*	50	2710370000
	Lever link for comparative measurement	LL TTB 6/3 CM	24 x 25.1 x 4.2 mm	orange	10	2726100000
	Lever link for comparative measurement	LL TTB 6/4 CM	32 x 25.1 x 4.2 mm	orange	10	2726110000
6	Switch lock	SL TTB 6	8 x 15 x 20 mm	red	50	2710220000
7	Endplate	EP TTB 6	2.1 x 34 x 61 mm	dark beige	20	2710170000
8	Terminal block marker	DEK 5/8 PLUS MC NE WS	8 x 2 x 5 mm	weiß	800	1046350000
9	Test plug	TS TTB 6 OR	6.3 x 9.5 x 51.5 mm	orange*	48	2710470000
10	Cross-connection	ZQV 6N/6	46.1 x 3.1 x 34 mm	orange*	20	2733950000
	Cross-connection	ZQV 6N/7	54.2 x 3.1 x 34 mm	orange*	20	2733960000
	Cross-connection	ZQV 6N/10	78.5 x 3.1 x 34 mm	orange*	20	2733970000
11	Instrument transformer wiring terminal block	ATTB 6	8.1 x 69 x 100 mm	dark beige*	50	2710090000
12	Instrument transformer wiring terminal block PE	ATTB 6 PE	8.1 x 69 x 100 mm	green/yellow	50	2710100000

* More colored version you will find inside our online catalogue



ATTB 6

6 mm²



ATTB 6 PE

6 mm²

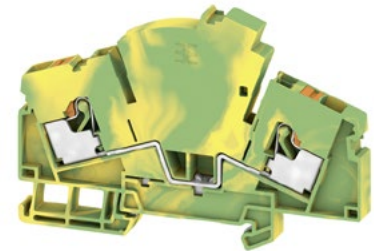

Width/Height/Depth	mm
max. current / max. cond. cross-section	A/mm ²
Max. clamping range	mm ²

8.1 x 100 x 68	
30 / 10	
0.5...10	

8.1 x 100 x 68	
/ 10	
0.5...10	

Technical data

Rated data	
Rated voltage	V
Rated current	A
for wire cross-section	mm ²
Short-time withstand current resistance	
Rated impulse withstand voltage / Pollution severity	
Gauge to IEC 60947-1 / UL 94 flammability rating	
Approvals	
Clamped conductors (H05V/H07V)	
Solid / Stranded	mm ²
Flexible / Flexible with ferrule	mm ²
Stripping length / Blade size	mm/-

IEC 60947-7-1

IEC	UL	CSA	EN 60079-7
500		600	
30		29	
6	AWG 22...8	AWG 22...8	
6 kV / 3			
A5 / V-0			

Rated connection

0.5...6 / 0.5...6
0.5...10 / 0.5...6
12 / 0.8 x 4.0 mm

IEC 60947-7-2

IEC	UL	CSA	EN 60079-7
6	AWG 22...8	AWG 22...8	
/ 3			
A5 / V-0			

Rated connection

0.5...6 / 0.5...6
0.5...10 / 0.5...6
12 / 0.8 x 4.0 mm

Note

Ordering data

Version	
	dark beige
	Green/yellow

Note

Type	Qty.	Order No.
ATTB 6	50	2710070000

Type	Qty.	Order No.
ATTB 6 PE	50	2710080000

Accessories

Short circuit bridge	
	2-pole
	3-pole
	4-pole
Cross-connector	
	6-pole
	7-pole
	10-pole
End plate	
	dark beige
Lever link	
	1-pole
	2-pole
	for comparative measurement 2-pole
Test plug	
	orange
	blue
	green
	yellow
	Black
	violet
Switch Lock	
Cover	
	Textile cover
	Cover profile
	Cover support
Marking tags	

Type	Qty.	Order No.
SCCB TTB 6/2	30 A 25	2710190000
SCCB TTB 6/3	30 A 25	2710200000
SCCB TTB 6/4	30 A 25	2710210000
ZQV 6N/6	41 A 20	2733950000
ZQV 6N/7	41 A 20	2733960000
ZQV 6N/10	41 A 20	2733970000
EP TTB 6	20	2710170000
LL TTB 6/1	50	2710230000
LL TTB 6/2	50	2710300000
LL TTB 6/2 CM	50	2710370000
TS TTB 6 OR	48	2710470000
TS TTB 6 BL	48	2710480000
TS TTB 6 GN	48	2710490000
TS TTB 6 YL	48	2710500000
TS TTB 6 BK	48	2710520000
TS TTB 6 VT	48	2710530000
SL TTB 6	50	2710220000
CH TTB	1	2710130000
CP TTB	10	2710140000
CS TTB	10	2710150000
DEK-A 5/8 MM WS	500	2448860000
DEK 5/8 PLUS MC NE WS	800	1046350000

Type	Qty.	Order No.
SCCB TTB 6/2	30 A 25	2710190000
SCCB TTB 6/3	30 A 25	2710200000
SCCB TTB 6/4	30 A 25	2710210000
ZQV 6N/6	41 A 20	2733950000
ZQV 6N/7	41 A 20	2733960000
ZQV 6N/10	41 A 20	2733970000
EP TTB 6	20	2710170000
LL TTB 6/1	50	2710230000
LL TTB 6/2	50	2710300000
LL TTB 6/2 CM	50	2710370000
TS TTB 6 OR	48	2710470000
TS TTB 6 BL	48	2710480000
TS TTB 6 GN	48	2710490000
TS TTB 6 YL	48	2710500000
TS TTB 6 BK	48	2710520000
TS TTB 6 VT	48	2710530000
SL TTB 6	50	2710220000
CH TTB	1	2710130000
CP TTB	10	2710140000
CS TTB	10	2710150000
DEK-A 5/8 MM WS	500	2448860000
DEK 5/8 PLUS MC NE WS	800	1046350000

For detailed information on other accessories and application in the online catalogue



Klippon® Connect TTB Range

Technical details and order numbers

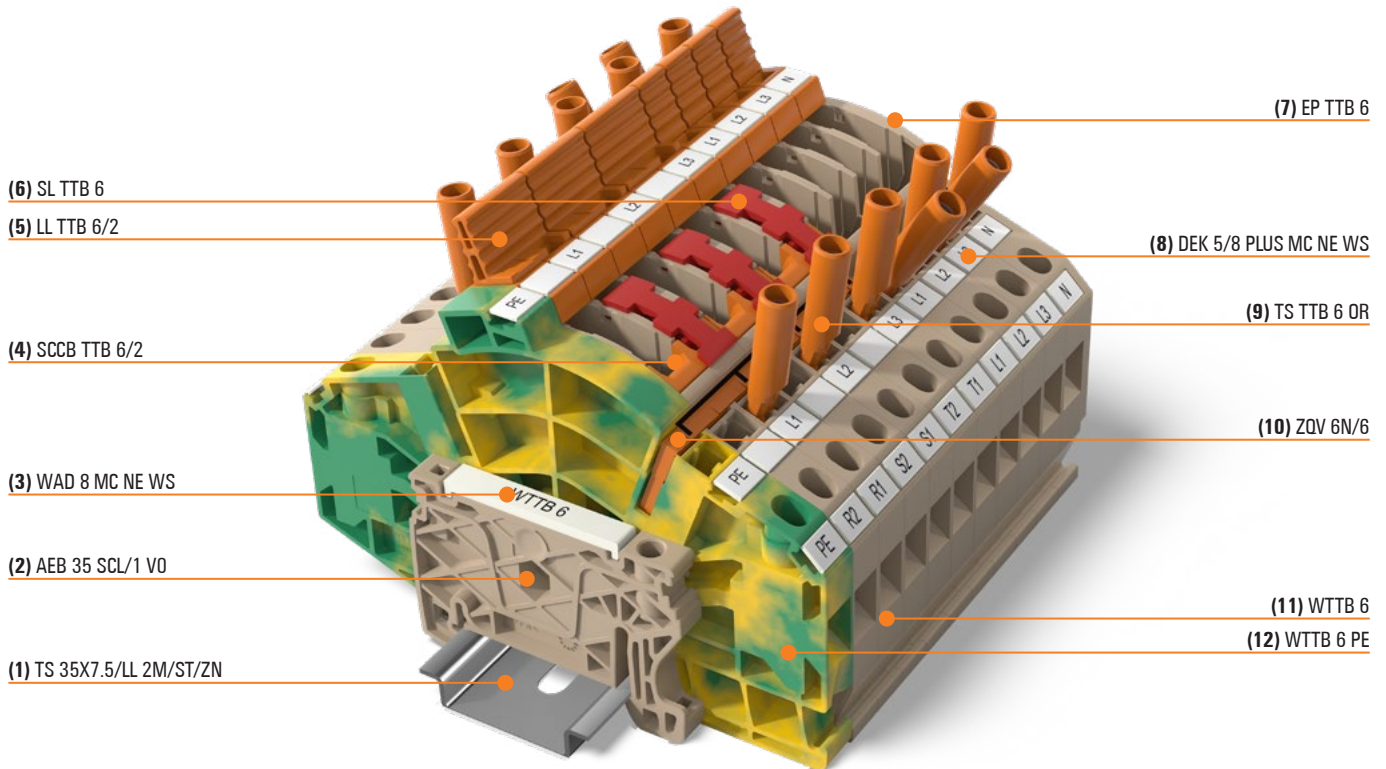

Overview of ordering data

Pos.	Description	Type	Dimensions	Color	Qty.	Order No.
1	Mounting rail	TS 35X7.5/LL 2M/ST/ZN	35 x 7.5 x 2000 mm	silver	2	0514500000
2	End bracket	AEB 35 SCL/1 V0	6 x 52.6 x 36.5 mm	dark beige*	50	2661280000
3	Group marker	WAD 5 MC NE WS	6 x 11.7 x 33.3 mm	white	48	1112910000
4	Short circuit bridge	SCCB TTB 6/2	16 x 13.5 x 14 mm	orange*	25	2710190000
	Short circuit bridge	SCCB TTB 6/3	24 x 13.5 x 14 mm	orange*	25	2710200000
	Short circuit bridge	SCCB TTB 6/4	32 x 13.5 x 14 mm	orange*	25	2710210000
5	Lever link	LL TTB 6/1	7.6 x 19.7 x 4 mm	orange*	50	2710230000
	Lever link	LL TTB 6/2	15.7 x 19.7 x 8.2 mm	orange*	50	2710300000
	Lever link	LL TTB 6/3	23.8 x 19.7 x 8.2 mm	orange	10	2710440000
	Lever link	LL TTB 6/4	31.9 x 19.7 x 8.2 mm	orange	10	2710450000
	Lever link	LL TTB 6/6	48.1 x 19.7 x 8.2 mm	orange	10	2710460000
	Lever link for comparative measurement	LL TTB 6/2 CM	15.9 x 25.1 x 4.2 mm	orange*	50	2710370000
	Lever link for comparative measurement	LL TTB 6/3 CM	24 x 25.1 x 4.2 mm	orange	10	2726100000
	Lever link for comparative measurement	LL TTB 6/4 CM	32 x 25.1 x 4.2 mm	orange	10	2726110000
6	Switch lock	SL TTB 6	8 x 15 x 20 mm	red	50	2710220000
7	Endplate	EP TTB 6	2.1 x 34 x 61 mm	dark beige	20	2710170000
8	Terminal block marker	DEK 5/8 PLUS MC NE WS	8 x 2 x 5 mm	weiß	800	1046350000
9	Test plug	TS TTB 6 OR	6.3 x 9.5 x 51.5 mm	orange*	48	2710470000
10	Cross-connection	ZQV 6N/6	46.1 x 3.1 x 34 mm	orange*	20	2733950000
	Cross-connection	ZQV 6N/7	54.2 x 3.1 x 34 mm	orange*	20	2733960000
	Cross-connection	ZQV 6N/10	78.5 x 3.1 x 34 mm	orange*	20	2733970000
11	Instrument transformer wiring terminal block	WTTB 6	8.1 x 69 x 100 mm	dark beige*	50	2710090000
12	Instrument transformer wiring terminal block PE	WTTB 6 PE	8.1 x 69 x 100 mm	green/yellow	50	2710100000

* More colored version you will find inside our online catalogue



WTTB 6

6 mm²



WTTB 6 PE

6 mm²

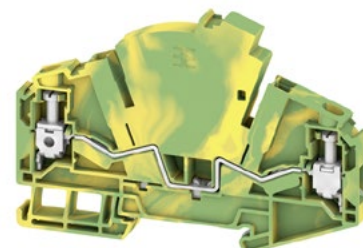

Width/Height/Depth	mm
max. current / max. cond. cross-section	A/mm ²
Max. clamping range	mm ²

8.1 x 100 x 69	
30 / 10	
0.5...10	

8.1 x 100 x 69	
/ 10	
0.5...10	

Technical data

Rated data	
Rated voltage	V
Rated current	A
for wire cross-section	mm ²
Short-time withstand current resistance	
Rated impulse withstand voltage / Pollution severity	
Gauge to IEC 60947-1 / UL 94 flammability rating	
Approvals	
Clamped conductors (H05V/H07V)	
Solid / Stranded	mm ²
Flexible / Flexible with ferrule	mm ²
Tightening torque	Nm
Stripping length / Blade size	mm/-

IEC 60947-7-1

IEC	UL	CSA	EN 60079-7
500	300	300	
30	30	30	
6	AWG 22...8	AWG 22...8	
6 kV / 3			
A4 / V-0			

CE

Rated connection	
0.5...10 / 0.5...10	
0.5...10 / 0.5...6	
0.8...1.6	
12 / 0.8 x 4.0 mm	

IEC 60947-7-2

IEC	UL	CSA	EN 60079-7
500			
6	AWG 22...8	AWG 22...8	
6 kV / 3			
A4 / V-0			

CE

Rated connection	
0.5...10 / 0.5...6	
0.5...10 / 0.5...6	
0.8...1.6	
12 / 0.8 x 4.0 mm	

Note

Ordering data

Version	
	dark beige
	Green/yellow

Note

Type	Qty.	Order No.
WTTB 6	50	2710090000

Type	Qty.	Order No.
WTTB 6 PE	50	2710100000

Accessories

Short circuit bridge	
	2-pole
	3-pole
	4-pole
Cross-connector	
	6-pole
	7-pole
	10-pole
End plate	
	dark beige
Lever link	
	1-pole
	2-pole
	for comparative measurement 2-pole
Test plug	
	orange
	blue
	green
	yellow
	Black
	violet
Switch Lock	
Cover	
	Textile cover
	Cover profile
	Cover support
Marking tags	

Type	Qty.	Order No.	
SCCB TTB 6/2	30 A	25	2710190000
SCCB TTB 6/3	30 A	25	2710200000
SCCB TTB 6/4	30 A	25	2710210000
ZQV 6N/6	41 A	20	2733950000
ZQV 6N/7	41 A	20	2733960000
ZQV 6N/10	41 A	20	2733970000
EP TTB 6		20	2710170000
LL TTB 6/1		50	2710230000
LL TTB 6/2		50	2710300000
LL TTB 6/2 CM		50	2710370000
TS TTB 6 OR		48	2710470000
TS TTB 6 BL		48	2710480000
TS TTB 6 GN		48	2710490000
TS TTB 6 YL		48	2710500000
TS TTB 6 BK		48	2710520000
TS TTB 6 VT		48	2710530000
SL TTB 6		50	2710220000
CH TTB		1	2710130000
CP TTB		10	2710140000
CS TTB		10	2710150000
DEK-A 5/8 MM WS		500	2448860000
DEK 5/8 PLUS MC NE WS		800	1046350000

Type	Qty.	Order No.	
SCCB TTB 6/2	30 A	25	2710190000
SCCB TTB 6/3	30 A	25	2710200000
SCCB TTB 6/4	30 A	25	2710210000
ZQV 6N/6	41 A	20	2733950000
ZQV 6N/7	41 A	20	2733960000
ZQV 6N/10	41 A	20	2733970000
EP TTB 6		20	2710170000
LL TTB 6/1		50	2710230000
LL TTB 6/2		50	2710300000
LL TTB 6/2 CM		50	2710370000
TS TTB 6 OR		48	2710470000
TS TTB 6 BL		48	2710480000
TS TTB 6 GN		48	2710490000
TS TTB 6 YL		48	2710500000
TS TTB 6 BK		48	2710520000
TS TTB 6 VT		48	2710530000
SL TTB 6		50	2710220000
CH TTB		1	2710130000
CP TTB		10	2710140000
CS TTB		10	2710150000
DEK-A 5/8 MM WS		500	2448860000
DEK 5/8 PLUS MC NE WS		800	1046350000

For detailed information on other accessories and application in the online catalogue



Klippon® Connect TTB-Range

Technical details and order numbers

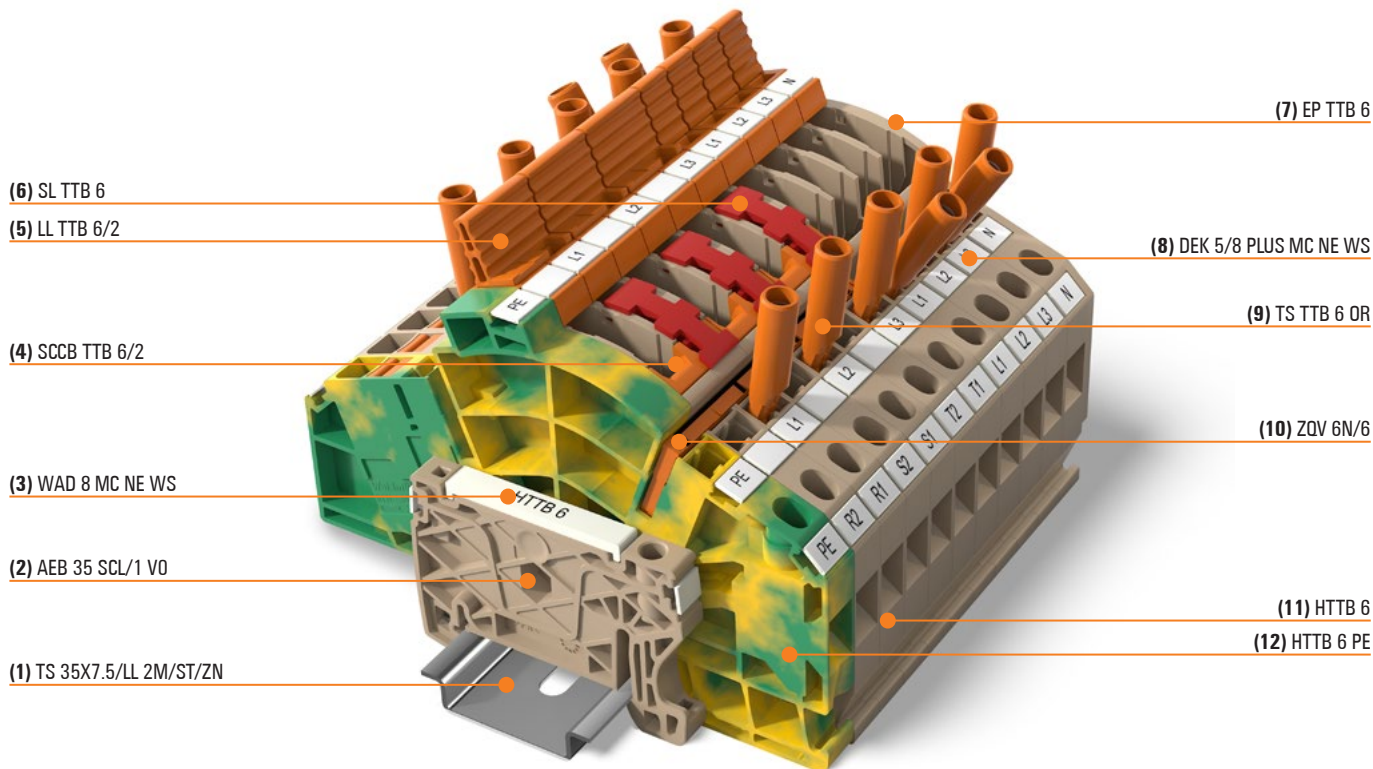

Overview of ordering data

Pos.	Description	Type	Dimensions	Color	Qty.	Order No.
1	Mounting rail	TS 35X7.5/LL 2M/ST/ZN	35 x 7.5 x 2000 mm	silver	2	051450000
2	End bracket	AEB 35 SCL/1 V0	6 x 52.6 x 36.5 mm	dark beige*	50	266128000
3	Group marker	WAD 5 MC NE WS	6 x 11.7 x 33.3 mm	white	48	111291000
4	Short circuit bridge	SCCB TTB 6/2	16 x 13.5 x 14 mm	orange*	25	271019000
	Short circuit bridge	SCCB TTB 6/3	24 x 13.5 x 14 mm	orange*	25	271020000
	Short circuit bridge	SCCB TTB 6/4	32 x 13.5 x 14 mm	orange*	25	271021000
5	Lever link	LL TTB 6/1	7.6 x 19.7 x 4 mm	orange*	50	271023000
	Lever link	LL TTB 6/2	15.7 x 19.7 x 8.2 mm	orange*	50	271030000
	Lever link	LL TTB 6/3	23.8 x 19.7 x 8.2 mm	orange	10	271044000
	Lever link	LL TTB 6/4	31.9 x 19.7 x 8.2 mm	orange	10	271045000
	Lever link	LL TTB 6/6	48.1 x 19.7 x 8.2 mm	orange	10	271046000
	Lever link for comparative measurement	LL TTB 6/2 CM	15.9 x 25.1 x 4.2 mm	orange*	50	271037000
	Lever link for comparative measurement	LL TTB 6/3 CM	24 x 25.1 x 4.2 mm	orange	10	272610000
	Lever link for comparative measurement	LL TTB 6/4 CM	32 x 25.1 x 4.2 mm	orange	10	272611000
6	Switch lock	SL TTB 6	8 x 15 x 20 mm	red	50	271022000
7	Endplate	EP TTB 6	2.1 x 34 x 61 mm	dark beige	20	271017000
8	Terminal block marker	DEK 5/8 PLUS MC NE WS	8 x 2 x 5 mm	weiß	800	104635000
9	Test plug	TS TTB 6 OR	6.3 x 9.5 x 51.5 mm	orange*	48	271047000
10	Cross-connection	ZQV 6N/6	46.1 x 3.1 x 34 mm	orange*	20	273395000
	Cross-connection	ZQV 6N/7	54.2 x 3.1 x 34 mm	orange*	20	273396000
	Cross-connection	ZQV 6N/10	78.5 x 3.1 x 34 mm	orange*	20	273397000
11	Instrument transformer wiring terminal block	HTTB 6	8.1 x 69 x 100 mm	dark beige*	50	271011000
12	Instrument transformer wiring terminal block PE	HTTB 6 PE	8.1 x 69 x 100 mm	green/yellow	50	271012000

* More colored version you will find inside our online catalogue

HTTB 6

6 mm²

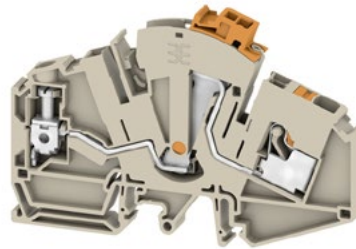

HTTB 6 PE

6 mm²

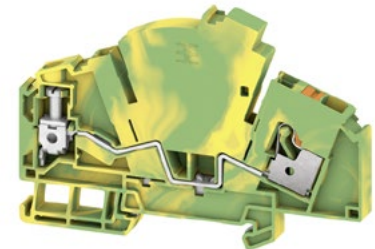

Width/Height/Depth	mm
max. current / max. cond. cross-section	A/mm ²
Max. clamping range	mm ²

8.1 x 100 x 68	
30 / 10	
0.5...10	

8.1 x 100 x 68	
/ 10	
0.5...10	

Technical data

Rated data	
Rated voltage	V
Rated current	A
for wire cross-section	mm ²
Short-time withstand current resistance	
Rated impulse withstand voltage / Pollution severity	
Gauge to IEC 60947-1 / UL 94 flammability rating	
Approvals	

IEC 60947-7-1

IEC	UL	CSA	EN 60079-7
500		600	
30		29	
6	AWG 22...8	AWG 22...8	
	6 kV / 3		
	A4 / V-0		

IEC 60947-7-2

IEC	UL	CSA	EN 60079-7
6	AWG 22...8	AWG 22...8	
	6 kV / 3		
	A4 / V-0		

Clamped conductors (H05V/H07V)

Solid / Stranded	mm ²
Flexible / Flexible with ferrule	mm ²
Tightening torque	Nm
Stripping length / Blade size	mm/-



Rated connection

0.5...10 / 0.5...10
0.5...10 / 0.5...6
0.8...1.6
12 / 0.8 x 4.0 mm



Rated connection

0.5...10 / 0.5...10
0.5...10 / 0.5...6
0.8...1.6
12 / 0.8 x 4.0 mm

Note

Ordering data

Version	dark beige Green/yellow
Note	

Type	Qty.	Order No.
HTTB 6	50	2710110000

Type	Qty.	Order No.
HTTB 6 PE	50	2710120000

Accessories

Short circuit bridge	
2-pole	
3-pole	
4-pole	
Cross-connector	
6-pole	
7-pole	
10-pole	
End plate	
dark beige	
Lever link	
1-pole	
2-pole	
for comparative measurement 2-pole	
Test plug	
orange	
blue	
green	
yellow	
Black	
violet	
Switch Lock	
Cover	
Textile cover	
Cover profile	
Cover support	
Marking tags	
For detailed information on other accessories and application in the online catalogue	

Type	Qty.	Order No.
SCCB TTB 6/2	30 A 25	2710190000
SCCB TTB 6/3	30 A 25	2710200000
SCCB TTB 6/4	30 A 25	2710210000
ZQV 6N/6	41 A 20	2733950000
ZQV 6N/7	41 A 20	2733960000
ZQV 6N/10	41 A 20	2733970000
EP TTB 6	20	2710170000
LL TTB 6/1	50	2710230000
LL TTB 6/2	50	2710300000
LL TTB 6/2 CM	50	2710370000
TS TTB 6 OR	48	2710470000
TS TTB 6 BL	48	2710480000
TS TTB 6 GN	48	2710490000
TS TTB 6 YL	48	2710500000
TS TTB 6 BK	48	2710520000
TS TTB 6 VT	48	2710530000
SL TTB 6	50	2710220000
CH TTB	1	2710130000
CP TTB	10	2710140000
CS TTB	10	2710150000
DEK-A 5/8 MM WS	500	2448860000
DEK 5/8 PLUS MC NE WS	800	1046350000

Type	Qty.	Order No.
SCCB TTB 6/2	30 A 25	2710190000
SCCB TTB 6/3	30 A 25	2710200000
SCCB TTB 6/4	30 A 25	2710210000
ZQV 6N/6	41 A 20	2733950000
ZQV 6N/7	41 A 20	2733960000
ZQV 6N/10	41 A 20	2733970000
EP TTB 6	20	2710170000
LL TTB 6/1	50	2710230000
LL TTB 6/2	50	2710300000
LL TTB 6/2 CM	50	2710370000
TS TTB 6 OR	48	2710470000
TS TTB 6 BL	48	2710480000
TS TTB 6 GN	48	2710490000
TS TTB 6 YL	48	2710500000
TS TTB 6 BK	48	2710520000
TS TTB 6 VT	48	2710530000
SL TTB 6	50	2710220000
CH TTB	1	2710130000
CP TTB	10	2710140000
CS TTB	10	2710150000
DEK-A 5/8 MM WS	500	2448860000
DEK 5/8 PLUS MC NE WS	800	1046350000



Simple, fast and safe wiring of current and voltage transformers

Klippon® Connect ATTB 6 PG range with pluggable connection for instrument transformer wiring

Where instrument transformer wiring requirements are coupled with enhanced wiring efficiency requests, all features of the TTB range can be exploited.

With the pluggable connection option located on the field side and directly connected to the instrument transformers, transformer circuits can now be wired even more securely.

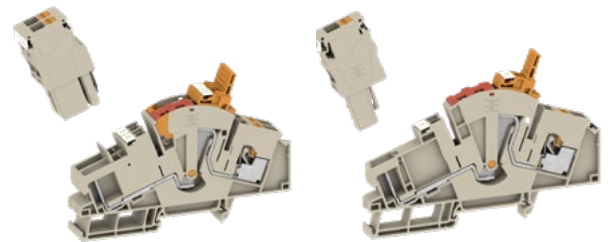
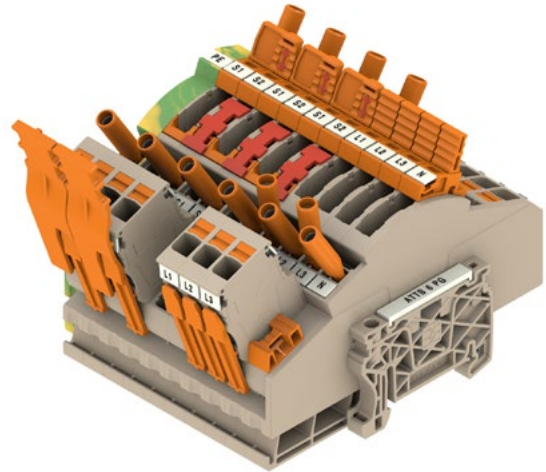

B

In current transformer circuits, the ATTB 6 PG CT is equipped with a specially designed 2 and 3 pole self-shorting plug able to guarantee a Make Before Break (MTB) contact under every handling condition. For voltage circuits a simple feed-through plug offered with the ATTB 6 PG VT guarantees the same handling easiness and safety required also for voltage circuits. Both CT and VT plugs are equipped with full coding possibility to avoid any dangerous exchange.

Protection relay application

The increased wiring effort required by protective relay circuits can be optimally managed with the ATTB 6 PG. Thanks to its pluggable interface, tangible operational advantages are made possible without compromising safety.

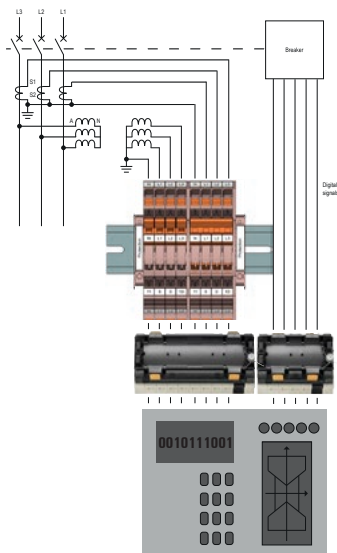

Metering application

ATTB 6 PG terminal blocks can be easily configured onto a rail in order to form a complete and functional connectivity interface in any metering cabinet. This allows intuitive, fast and safe handling for any operator.

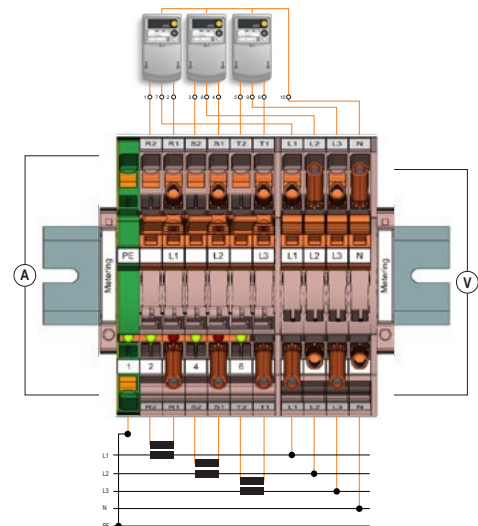

Voltage circuits do not require special operational safety other than avoiding short circuit on the secondary wiring if a VT is used. For current transformer assisted circuits, it is on the other hand of paramount importance to perform a preliminary shorting of a CT prior to any circuit opening.

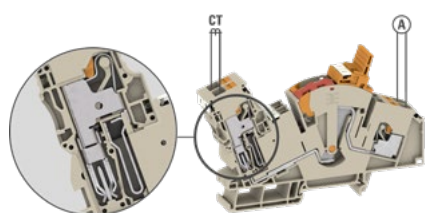

Normal operation – CT circuits

In normal operation, the plug is fully inserted. The circuit is closed and the current flows via the terminal blocks and the plug.

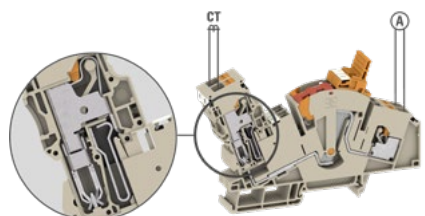
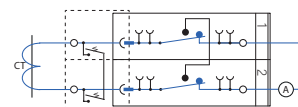
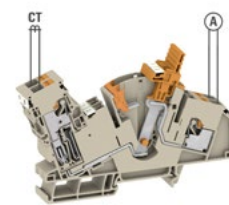
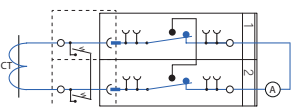

Make Before Break (MBB)– CT circuits

Throughout cabinet operational life or during assembly verifications, the circuit must be disconnected to allow further operations. To do so, the plug is partially extracted from the terminals. Before extraction is fully completed, a short circuit is established between its two poles. In a likewise manner, the same circuit status can be obtained by bringing the lever into its middle position.

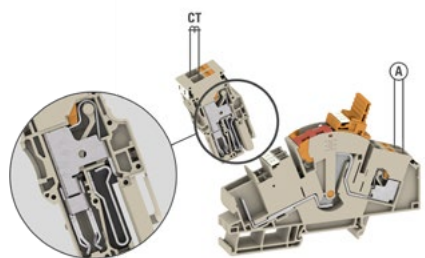
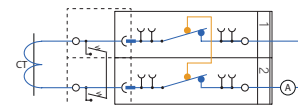
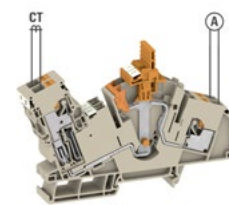
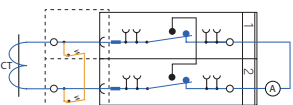

Disconnect & short circuit – CT circuits

To fully allow consequent operations, the plug is completely extracted from the base terminals, thus maintaining the previously established short circuit between its poles and subsequently opening the circuit. The circuit can be equally safely and completely opened completing the rotation of the lever to the left. As a result the system allows the operator to enjoy a redundant Make Before Break contact.

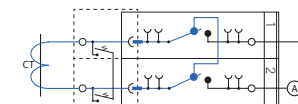
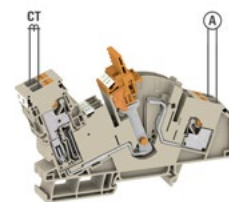
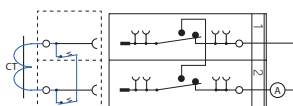

B



Klippon® Connect TTB-Range

Technical details and order numbers

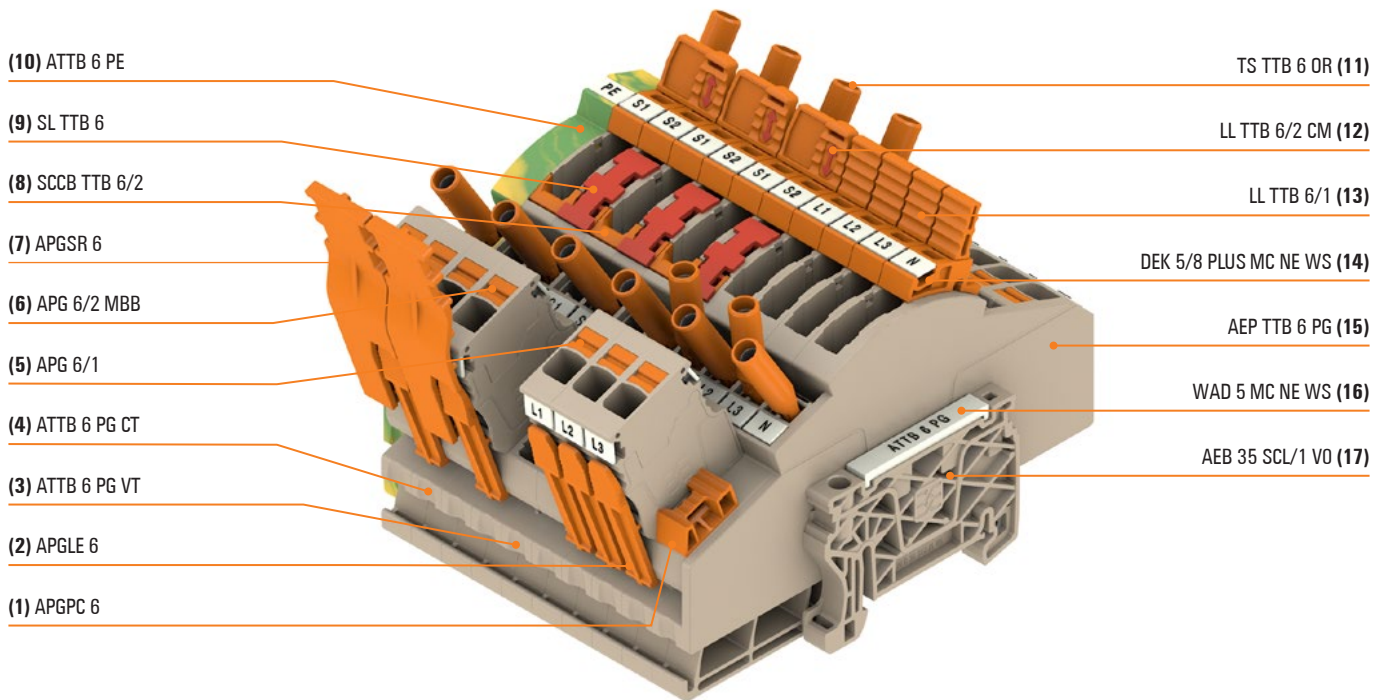

Overview of ordering data

Pos.	Description	Type	Dimensions	Color	Qty.	Order No.
	Mounting rail	TS 35X7.5/LL 2M/ST/ZN	35 x 7.5 x 2000 mm	silver	2	0514500000
1	Protective cover	APGPC 6	7.9 x 15.5 x 20 mm	orange	20	2762410000
2	Locking element	APGLE 6	6.5 x 2.49 x 35.96 mm	orange	20	2762400000
3	Instrument transformer wiring terminal block (Voltage)	ATTB 6 PG VT	8.1 x 109 x 68 mm	dark beige*	50	2762290000
4	Instrument transformer wiring terminal block (Current)	ATTB 6 PG CT	8.1 x 109 x 68 mm	dark beige*	50	2762280000
5	Standard feed-through plug	APG 6/1	8.1 x 24.3 x 51 mm	beige	50	2762320000
6	Plug with Make Before Breake-funktion (MBB)	APG 6/2 MBB	16.2 x 27.5 x 51 mm	beige	20	2762330000
	Plug with Make Before Breake-funktion (MBB)	APG 6/3 MBB	24.3 x 27.5 x 51 mm	beige	20	2762340000
7	Strain relief	APGSR 6	15.9 x 7.7 x 58.1 mm	orange	20	2762390000
8	Short circuit bridge	SCCB TTB 6/2	16 x 13.5 x 14 mm	orange*	25	2710190000
	Short circuit bridge	SCCB TTB 6/3	24 x 13.5 x 14 mm	orange*	25	2710200000
	Short circuit bridge	SCCB TTB 6/4	32 x 13.5 x 14 mm	orange*	25	2710210000
9	Switch lock	SL TTB 6	8 x 15 x 20 mm	red	50	2710220000
10	Instrument transformer wiring terminal block PE	ATTB 6 PE	8.1 x 69 x 100 mm	green/yellow	50	2710100000
11	Test plug	TS TTB 6 OR	6.3 x 9.5 x 51.5 mm	orange*	48	2710470000
12	Lever link for comperative measurement	LL TTB 6/2 CM	15.9 x 25.1 x 4.2 mm	orange*	50	2710370000
	Lever link for comperative measurement	LL TTB 6/3 CM	24 x 25.1 x 4.2 mm	orange	10	2726100000
	Lever link for comperative measurement	LL TTB 6/4 CM	32 x 25.1 x 4.2 mm	orange	10	2726110000
13	Lever link	LL TTB 6/1	7.6 x 19.7 x 4 mm	orange*	50	2710230000
	Lever link	LL TTB 6/2	15.7 x 19.7 x 8.2 mm	orange*	50	2710300000
	Lever link	LL TTB 6/3	23.8 x 19.7 x 8.2 mm	orange	10	2710440000
	Lever link	LL TTB 6/4	31.9 x 19.7 x 8.2 mm	orange	10	2710450000
	Lever link	LL TTB 6/6	48.1 x 19.7 x 8.2 mm	orange	10	2710460000
14	Terminal block marker	DEK 5/8 PLUS MC NE WS	8 x 2 x 5 mm	weiß	800	1046350000
15	Endplate	AEP TTB 6 PG	2.1 x 108.8 x 50.77 mm	dark beige	20	2762310000
16	Group marker	WAD 5 MC NE WS	6 x 11.7 x 33.3 mm	white	48	1112910000
17	End bracket	AEB 35 SCL/1 VO	6 x 52.6 x 36.5 mm	dark beige*	50	2661280000
	Cross-connection	ZQV 6N/6	46.1 x 3.1 x 34 mm	orange*	20	2733950000
	Cross-connection	ZQV 6N/7	54.2 x 3.1 x 34 mm	orange*	20	2733960000
	Cross-connection	ZQV 6N/10	78.5 x 3.1 x 34 mm	orange*	20	2733970000
	Cooding element	APGCE	2.25 x 11 x 3.3 mm	orange	50	1514490000

* More colored version you will find inside our online catalogue

ATTB 6 PG CT

6 mm²

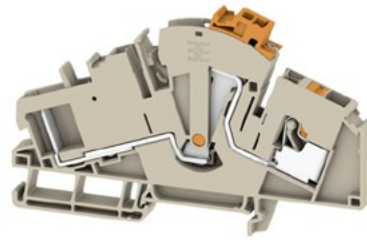

ATTB 6 PG VT

6 mm²

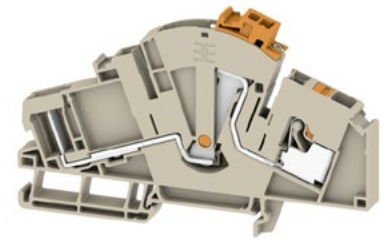

Width/Height/Depth	mm
max. current / max. cond. cross-section	A/mm ²
Max. clamping range	mm ²

8.1 x 109 x 68	
30 / 10	
0.5...10	

8.1 x 109 x 68	
30 / 10	
0.5...10	

Technical data

Rated data	
Rated voltage	V
Rated current	A
for wire cross-section	mm ²
Short-time withstand current resistance	
Rated impulse withstand voltage / Pollution severity	
Gauge to IEC 60947-1 / UL 94 flammability rating	
Approvals	
Clamped conductors (H05V/H07V)	
Solid / Stranded	mm ²
Flexible / Flexible with ferrule	mm ²
Tightening torque	-
Stripping length / Blade size	mm/-

IEC 60947-7-1			
IEC	UL	CSA	EN 60079-7
500	300		
30	10		
6	AWG 22...8		
6 kV / 3			
A5 / V-0			
Rated connection			
0.5...6 / 0.5...6			
0.5...10 / 0.5...6			
12 / 0.8 x 4.0 mm			

IEC 60947-7-1			
IEC	UL	CSA	EN 60079-7
500	300		
30	29		
6	AWG 22...8		
6 kV / 3			
A5 / V-0			
Rated connection			
0.5...6 / 0.5...6			
0.5...10 / 0.5...6			
12 / 0.8 x 4.0 mm			

Note

Ordering data

Version	
	dark beige
Note	

Type	Qty.	Order No.
ATTB 6 PG CT	50	2762280000

Type	Qty.	Order No.
ATTB 6 PG VT	50	2762290000

Accessories

Plug	
	1-pole
	2-pole
	3-pole
	4-pole
Short circuit bridge	
	2-pole
	3-pole
	4-pole
Cross-connector	
	6-pole
	7-pole
	10-pole
End plate	dark beige
Lever link	
	1-pole
	2-pole
	for comparative measurement 2-pole
Test plug	orange
Switch Lock	
Marking tags	
Plug with make before break-function (MBB)	
	2-pole
	3-pole

Type	Qty.	Order No.
SCCB TTB 6/2	30 A 25	2710190000
SCCB TTB 6/3	30 A 25	2710200000
SCCB TTB 6/4	30 A 25	2710210000
ZQV 6N/6	41 A 20	2733950000
ZQV 6N/7	41 A 20	2733960000
ZQV 6N/10	41 A 20	2733970000
AEP TTB 6 PG	20	2762310000
LL TTB 6/1	50	2710230000
LL TTB 6/2	50	2710300000
LL TTB 6/2 CM	50	2710370000
TS TTB 6 OR	48	2710470000
SL TTB 6	50	2710220000
DEK 5/8 PLUS MC NE WS	800	1046350000
DEK 5/8 PLUS MC WS LRP	800	2770670000
APG 6/2 MBB	30 A 20	2762330000
APG 6/3 MBB	30 A 20	2762340000

Type	Qty.	Order No.
APG 6/1	30 A 50	2762320000
APG 6/2	30 A 50	2882750000
APG 6/3	30 A 50	2882690000
APG 6/4	30 A 25	2829060000
SCCB TTB 6/2	30 A 25	2710190000
SCCB TTB 6/3	30 A 25	2710200000
SCCB TTB 6/4	30 A 25	2710210000
ZQV 6N/6	41 A 20	2733950000
ZQV 6N/7	41 A 20	2733960000
ZQV 6N/10	41 A 20	2733970000
AEP TTB 6 PG	20	2762310000
LL TTB 6/1	50	2710230000
LL TTB 6/2	50	2710300000
LL TTB 6/2 CM	50	2710370000
TS TTB 6 OR	48	2710470000
SL TTB 6	50	2710220000
DEK 5/8 PLUS MC NE WS	800	1046350000
DEK 5/8 PLUS MC WS LRP	800	2770670000

For detailed information on other accessories and application in the online catalogue



Instrument transformer wiring TTB Range – Accessories

Accessories for test-disconnect terminal TTB 6

Short circuit bridge

The short circuit bridge can be simply and quickly inserted into the terminal blocks. If several levers are connected simultaneously with the lever connector, the make before break can be realised. Once mounted, the short circuit bridge cannot be removed from the application.

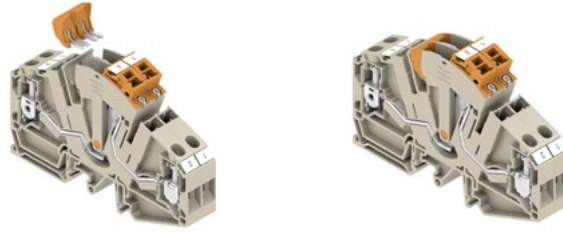

SCCB TTB 6



Type	Qty.	Order No.
SCCB TTB 6/2	25	2710190000
SCCB TTB 6/3	25	2710200000
SCCB TTB 6/4	25	2710210000

Lever link

The lever link mechanically locks the connected disconnect levers of the terminal blocks. Switching the lever link together with the inserted short circuit bridge allows make before break functionality inside the application. Once mounted, the lever link cannot be removed from the application.



LL TTB 6



Type	Qty.	Order No.
LL TTB 6/1	50	2710230000
LL TTB 6/2	50	2710300000
LL TTB 6/3	50	2710440000
LL TTB 6/4	25	2710450000
LL TTB 6/6	10	2710460000

More colours at catalog.weidmueller.com

Comparative measurement lever link

The LL TTB 6 CM enables safe and fast comparative measurement. After lifting the LL TTB 6 CM, the two levers of the terminal blocks are mechanically separated from each other and can be switched independently. Once mounted, the lever link cannot be removed from the application.



LL TTB 6 CM



Type	Qty.	Order No.
LL TTB 6/2 CM	50	2710370000
LL TTB 6/3 CM	50	2726100000
LL TTB 6/4 CM	50	2726110000

More colours at catalog.weidmueller.com

Test socket

The test socket is used to connect test devices with a standard 4.0 plug with widths up to 10 mm into the terminal. Test sockets are arranged at an angle, therefore all standard measurements (even adjoining) can be realised within the terminal width of 8.1 mm. Once mounted, the test socket cannot be removed from the application.



TS TTB 6



Type	Qty.	Order No.
TS TTB 6 OR	48	2710470000
TS TTB 6 BL	48	2710480000
TS TTB 6 YL	48	2710500000
TS TTB 6 GN	48	2710490000
TS TTB 6 VT	48	2710530000

More colours at catalog.weidmueller.com



Cross-connection

The cross-connection enables potential multiplication or the realisation of a star connection within the application.

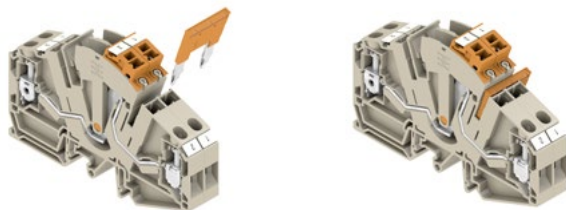

Contour-like PE terminal block

A PE terminal block with identical contour is a very useful component in a test-disconnect terminal block system, since it allows easy and safe realisation of star connection / reference points within the application.



Switch lock

The switch lock can be easily inserted into the terminal from above. The switch lock prevents unauthorised opening or closing of circuits as they block the disconnect lever in its respective position.

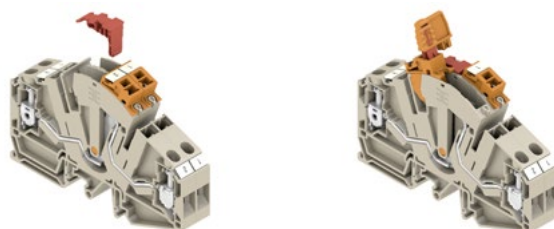

Combi-foot (for WTTB 6 and HTTB 6)

Integrated combi-foot allows easy and quick mounting onto all available TH 35 and G32 rails, thus allowing cost and time effective panel retrofit.



ZQV 6N/...



Type	Qty.	Order No.
ZQV 6N/4	60	1985780000
ZQV 6N/6	20	2733950000
ZQV 6N/7	20	2733960000
ZQV 6N/10	20	2733970000

TTB 6 PE



Type	Qty.	Order No.
ATTB 6 PE	50	2710080000
WTTB 6 PE	50	2710100000
HTTB 6 PE	50	2710120000

SL TTB 6



Type	Qty.	Order No.
SL TTB 6	50	2710220000

TS35 x... / TS32 x...

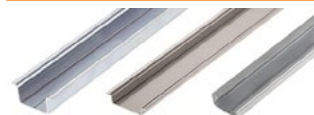

Type	Qty.	Order No.
TS 32X15 2M/ST/ZN	2	0122800000
TS 35X7.5/LL 2M/ST/ZN	2	0514500000
TS 35X15/LL 2M/ST/ZN	2	0236500000



Accessories for test-disconnect terminal TTB 6

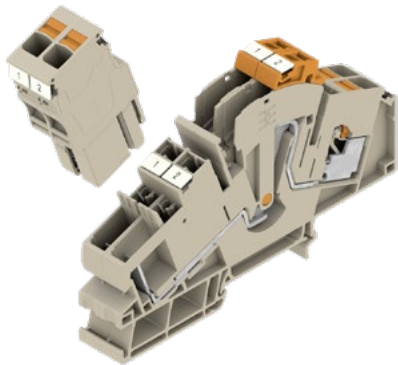

Plug with MBB function

The specially designed 2- and 3-pole self shorting plugs offer, in addition to all handling advantages, a guarantee make-before-break contact.

Type	Qty.	Order No.
APG 6/2 MBB	50	2762330000
APG 6/3 MBB	50	2762340000

B

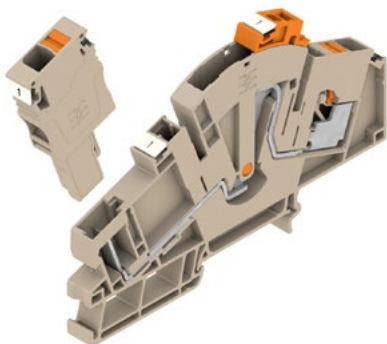

Standard plug

For voltage circuits a simple feed-through plug offered with the ATTB 6 PG VT guarantees the same handling easiness and safety required also for voltage circuits.

Type	Qty.	Order No.
APG 6/1	50	2762320000
MCV APG 6	50	2762380000

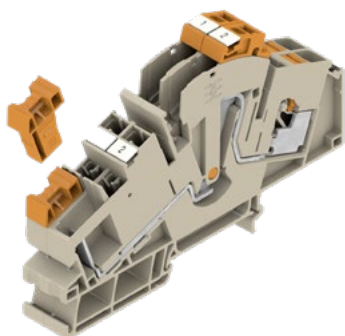

Protective cover

The cover of the plug contact offers protection from external influences, e.g. soiling from dust.

Type	Qty.	Order No.
APGPC 6	50	2762410000

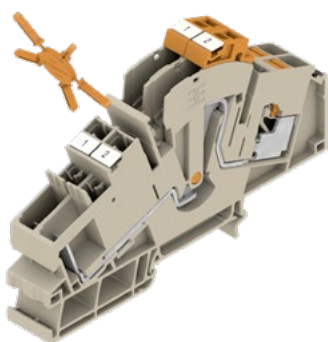

Coding element

With the use of coding pins, individual coding options ensure trouble-free plug-in connection.

Type	Qty.	Order No.
APGCE	50	1514490000

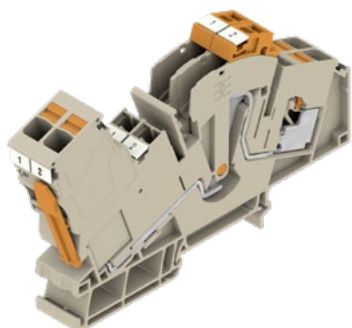

Locking element

The plugs can be securely and easily fixed to the base terminal by using a locking element. The locking element avoids an unintentional disconnection of the plugs from the base terminal and ensures maximum safety.

Type	Qty.	Order No.
APGLE	50	2762400000

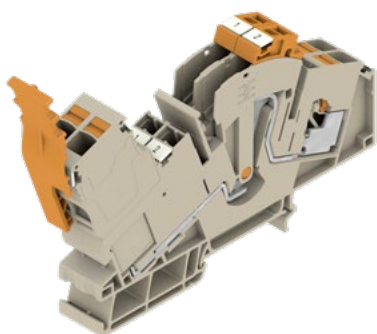

Strain relief

The strain relief protects the contact against mechanical stress and protects the connector against inadvertent release from the contact point

Type	Qty.	Order No.
APGSR	50	2762390000



Application examples

Changing a Protection/Metering device

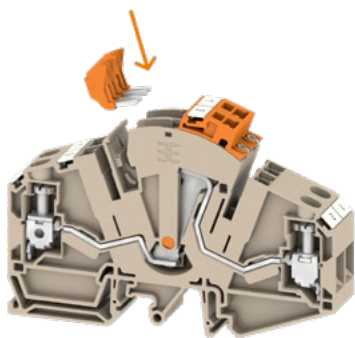

Planning and installation: Equipping the terminal blocks with accessories

1. SCCB TTB 6 short circuit bridge installation in progress

The short circuit bridge is inserted quickly and easily on the transformer side of the terminal block in its dedicated channel. Once mounted, the short circuit bridge cannot be removed from the application.

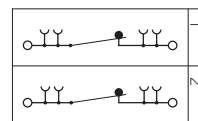

B

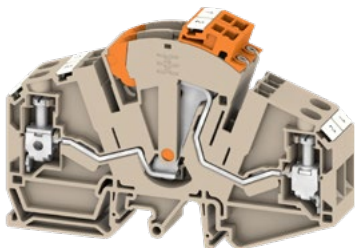

2. SCCB TTB 6 short circuit bridge installation completed

When inserted, depending on the position of the disconnect lever, an electrical connection (short circuit) between the two terminal blocks can be realised.

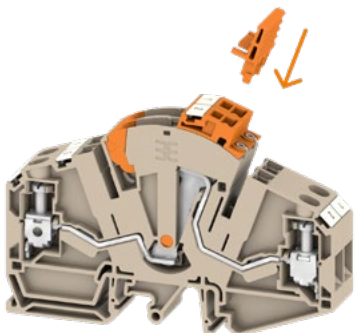
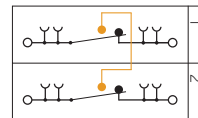

3. LL TTB 6 lever link installation in progress

The lever link is plugged into the housings of the disconnect lever of the respective terminal blocks from above and creates a mechanical connection between them. Once mounted, the lever link cannot be removed from the application.

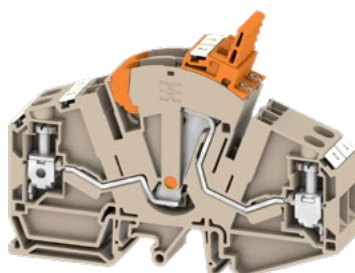
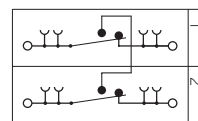

4. LL TTB 6 lever link installation completed

The mechanical connection between the lever mechanisms allows simultaneous opening or closing of two or more disconnect levers.

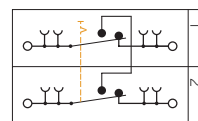

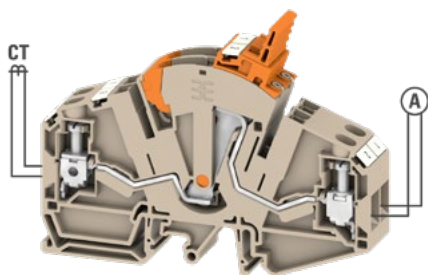

Installation: Wiring transformer and ammeter wiring

Wiring of current transformer and ammeter

The transformer will be connected in the clamping units upstream the disconnect lever and the ammeter will be connected in the clamping units downstream the disconnect lever.

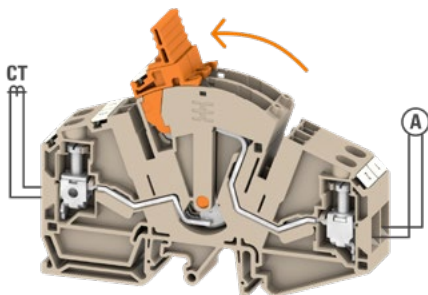
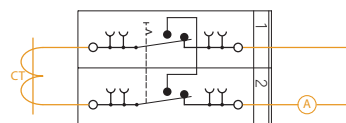

Operation: Changing an ammeter

1. Switching the lever link

Switching the lever link causes an automatic short circuit (make before break mechanism) on the secondary wiring of the current transformer. This prevents the voltage on the current transformer from surging and protects it from damage leading to its destruction.

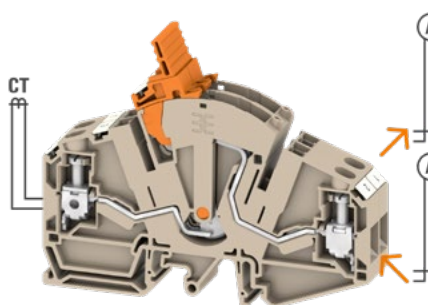
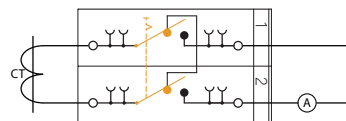

2. Replacing the ammeter

After short-circuiting the current transformer side and simultaneously disconnecting the circuit through the lever switching, the ammeter can be replaced easily and safely.

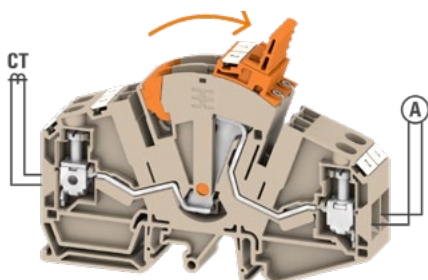
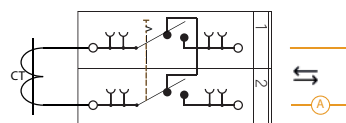

3. Restoring the lever link back into original position

Switching backwards the lever, restores the entire arrangement into its original status. The transition from the automatic short circuit back to the initial position is realised smoothly and safely.

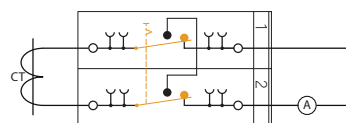

Application examples

Performing a comparative measurement



Planning and installation: Equipping the terminal blocks with accessories

1. SCCB TTB 6 short circuit bridge installation in progress

The short circuit bridge is inserted quickly and easily on the transformer side of the terminal block in its dedicated channel. Once mounted, the short circuit bridge cannot be removed from the application.

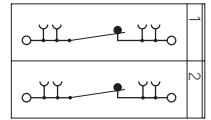

B

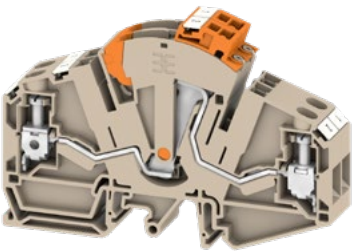

2. SCCB TTB 6 short circuit bridge installation completed

When inserted, depending on the position of the disconnect lever, an electrical connection (short circuit) between the two terminal blocks can be realised.

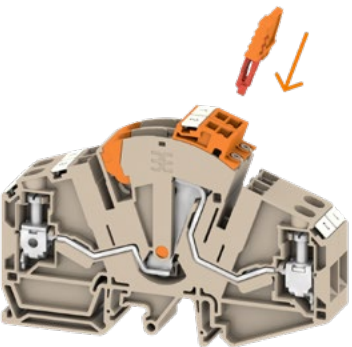
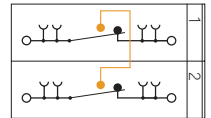

3. LL TTB 6 CM lever link installation in progress

The CM lever link (having long, asymmetrical, red coloured foot) is plugged into the housings of the disconnect lever of the respective terminal blocks from above and creates a mechanical connection between them. Once mounted, the lever link cannot be removed from the application.

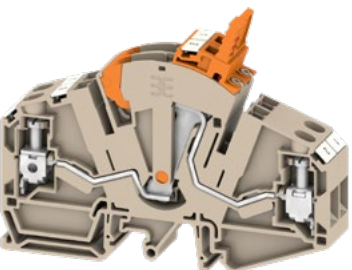
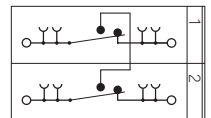

4. LL TTB 6 CM lever link installation completed

The mechanical connection of the lever mechanisms allows simultaneous opening or closing of two or more disconnect levers. By lifting the LL TTB 6 CM, the two (or more) disconnect levers of the terminal blocks are disengaged from each other and can be switched independently. Prior to any re-energising of the circuit, the CM needs to be pushed down into original position and the circuit closed.

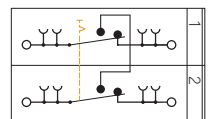

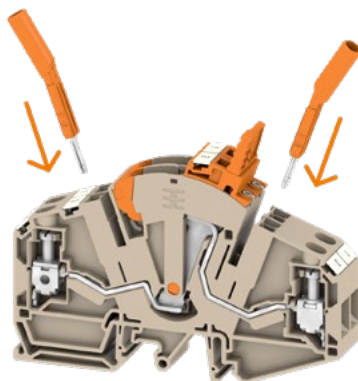

5. TS TTB 6 test sockets installation in progress

The TS TTB 6 test sockets are inserted into the bespoke housings provided in the terminal blocks from above. Once inserted, the test sockets cannot be removed from the installation.

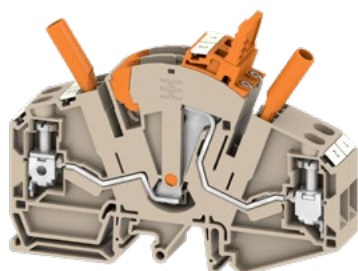
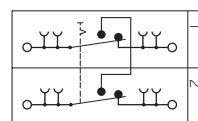

6. TS TTB 6 test sockets installation completed

The test sockets are used to connect test devices with a standard 4.0 plug with widths up to 10 mm into the terminal. Test sockets are arranged at an angle, therefore all standard measurements (even adjoining) can be realised within the terminal width of 8.1 mm. Once mounted, the test socket cannot be removed from the application.

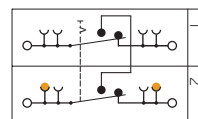

B

Installation: Wiring the transformer and the ammeter

The transformer will be connected in the clamping unit upstream the disconnect lever and the ammeter will be connected in the clamping units downstream the disconnect lever.

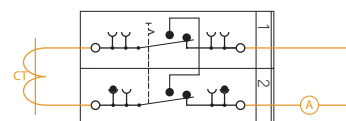
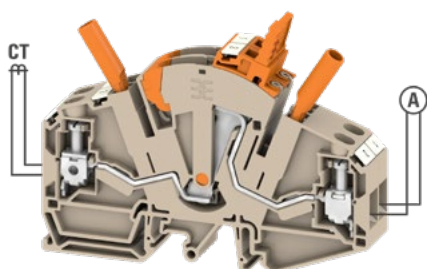

Application examples

Performing a comparative measurement

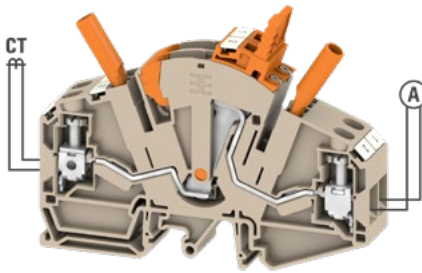

Operation: Performing a comparative measurement

1. Configuration correctly equipped

The installation of the required accessories to equip the terminal arrangement for comparative measurement and also the wiring of the primary side as well as the secondary side, has already been carried out. The installation is correctly prepared to perform the required operations.

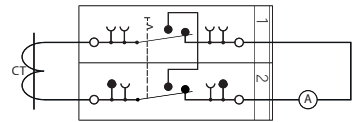

B

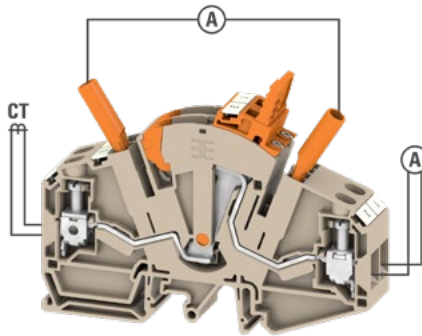

2. Connection of a reference measuring (calibrated) instrument

The reference measuring (calibrated) instrument is connected via standard 4.0 plugs to the test sockets on a terminal block. The connection is made inserting in parallel the calibrated instrument to the terminal block, where the disconnection will take place.

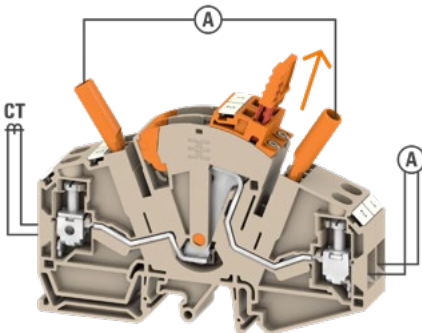
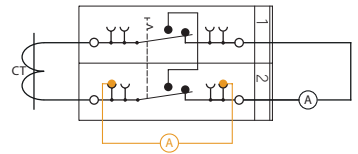

3. Lifting up the LL TTB 6 CM lever link

Lifting up the lever link LL TTB 6 CM causes a mechanical decoupling of the two disconnect levers. Now the two disconnect levers can be operated independently from each other within this application.

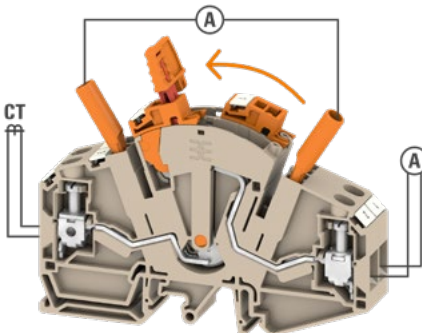
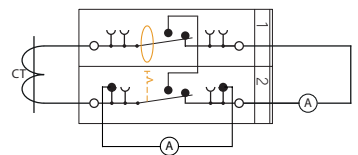

4. Switching the LL TTB 6 CM lever link

By switching the previously decoupled lever link, the current flow is diverted from the terminal block through the now parallel-connected reference measuring instrument.

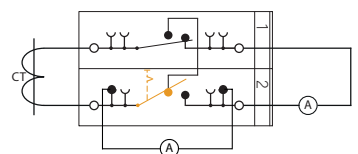

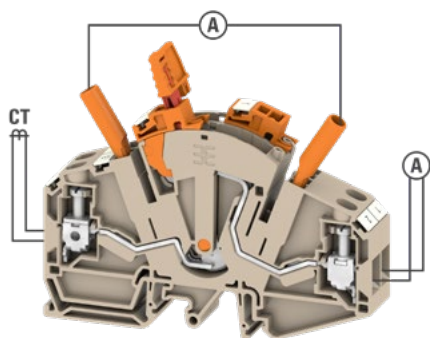

5. Performing the comparative reading of the two ammeters

The values measured by the ammeter connected downstream can now be compared with the values given by the reference meter since both instruments are reading the same current. The comparison measurement has now been successfully completed and the correct functional verification of the ammeter connected downstream the terminal has been carried out.

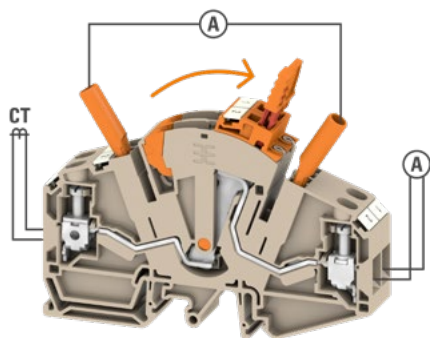
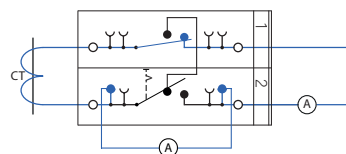

6. Restoring the lever link back into original position

Switching backwards the lever, restores the entire arrangement into its original status. The transition from the comparative measurement status back to the initial position is realised smoothly and safely.

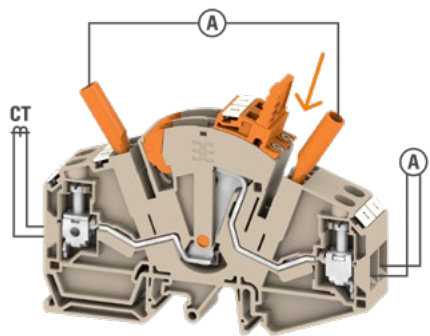
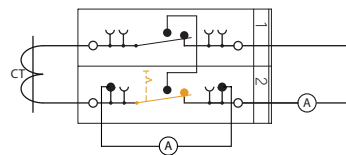

7. Pressing down the LL TTB 6 CM lever link

Pressing down the LL TTB 6 CM lever link restores the mechanical connection of the two disconnect levers within the application.

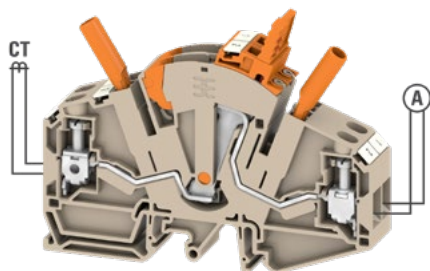
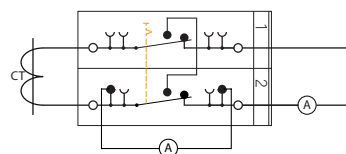

8. Disconnecting of the reference measuring instrument

The reference measurement instrument is therefore disconnected from the installation by simply removing its plugs from the test sockets of the terminal block and the installation is restored in the initial status.

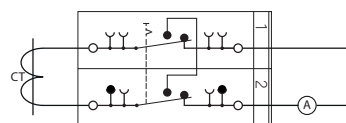

Simple, fast, and safe wiring of current and voltage transformers

Klippon[®] Connect instrument transformer wiring terminal blocks

In energy monitoring, incorrect wiring can destroy current and voltage transformers. Our specially developed test-disconnect terminal blocks, in various connection technologies, are a safe way of solving this problem. Simple operation ensures error-free, convenient wiring. This guarantees the protection of your transformers and measuring devices and ensures safe, precise work. Our integrated terminal blocks, in modular design for transformer switches, also save space in the panel.

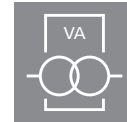

B



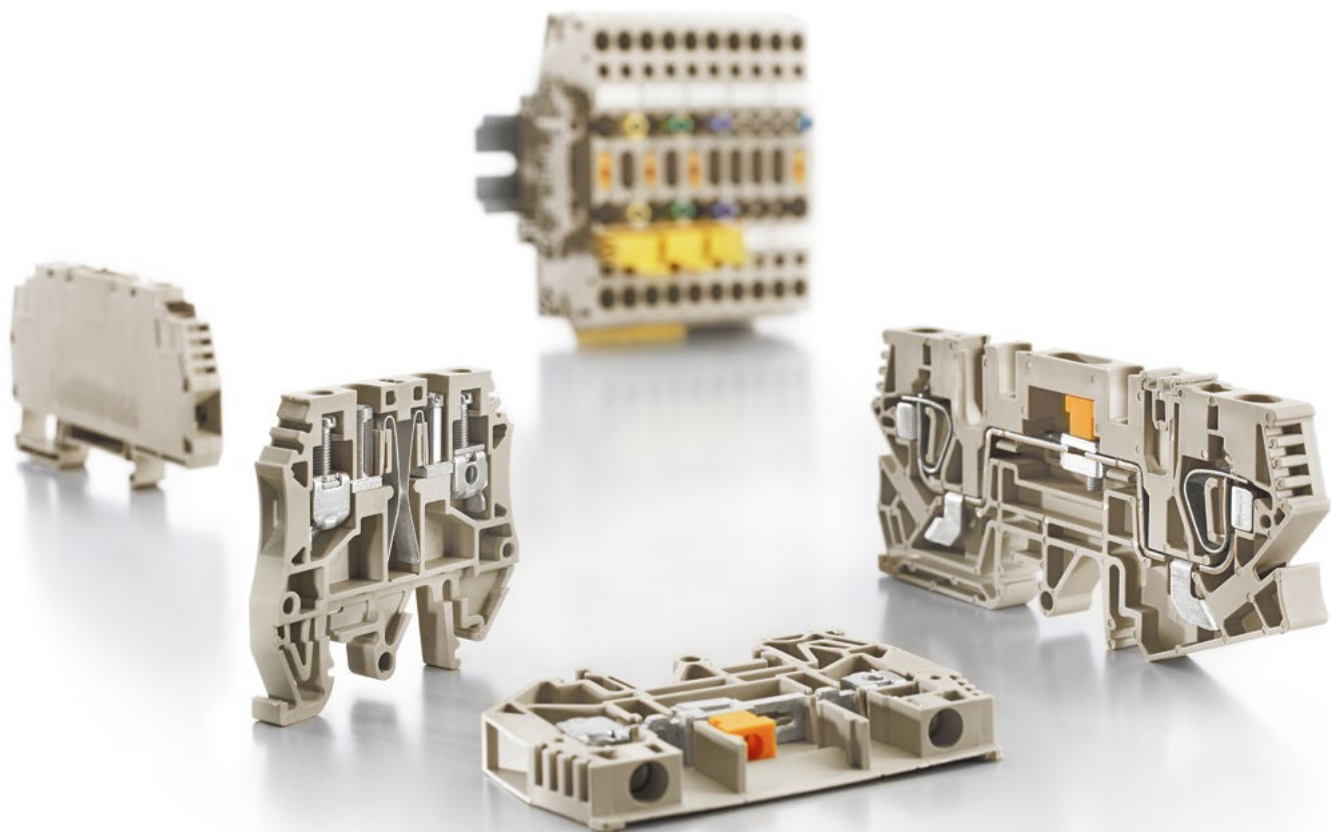

Instrument transformer wiring terminal blocks with tension clamp connection

The simple operating system with a spring connection and the clear identification of the switch status guarantee safe short-circuiting and disconnecting at all times.

Instrument transformer wiring terminal blocks with screw connection

With our test-disconnect terminal blocks, based on tested Weidmüller screw connection technology, connecting challenges can be resolved clearly and costeffectively.

Instrument transformer wiring terminal blocks with stud connection

The Instrument transformer wiring terminal blocks SDL 4 with stud connection technology enables simple instrument transformer wiring of ring cable lugs.



Instrument transformer wiring

Tension clamp connection

Test-disconnect terminal blocks

Test-disconnect terminal blocks for measuring with ZTL 6

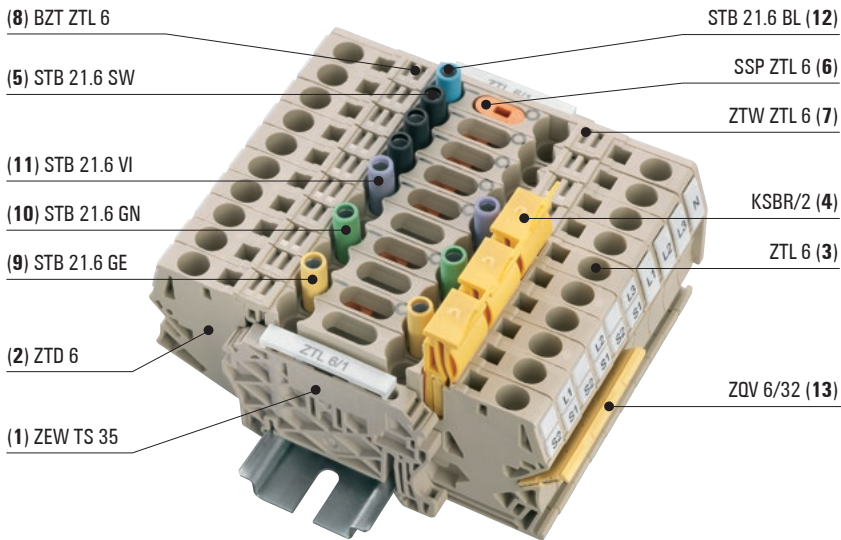

Ordering data

Pos.	Type	Order No.	Qty.
1	ZEW TS 35 (nur TS 35)	954000000	20
1	EWK1 (nur TS 32)	0206160000	50
2	ZTD 6	1771810000	20
3	ZTL 6	1771800000	20
4	KSBR/2	1771820000	50
5	STB 21.6 SW	1071040000	50
6	SSP ZTL 6	1771860000	100
7	ZTW ZTL 6	1771870000	20
8	BZT ZTL 6	1781140000	20

Optionally available for better labelling (instead of 11 x Pos. 5):

Pos.	Type	Order No.	Qty.
9	STB 21.6 GE	1071010000	50
10	STB 21.6 GN	1071020000	50
11	STB 21.6 VI	1071030000	50
12	STB 21.6 BL	1071080000	50
Optionally available for a shared k-point:			
13	ZQV 6/32 GE	1733640000	10



ZTD 6

6 mm²

Feed-through terminal

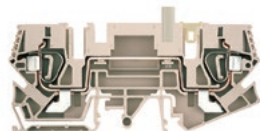

Width/Height/Depth	mm
max. current / max. cond. cross-section	A/mm ²
Max. clamping range	mm ²

8 x 106 x 46.5
52 / 10
0.5...10

Technical data

Rated data	
Rated voltage	V
Rated current	A
for wire cross-section	mm ²
Rated impulse withstand voltage / Pollution severity	
Gauge to IEC 60947-1 / UL 94 flammability rating	
Approvals	
Clamped conductors (H05V/H07V)	
Solid / Stranded	mm ²
Flexible / Flexible with ferrule	mm ²
Twin wire-end ferrule	-
Stripping length / Blade size	mm/-

IEC 60947-7-1

IEC	UL	CSA	EN 60079-7
800	300	300	
41	33	33	
6	AWG 20...8	AWG 20...8	
8 kV / 3			
A5 / V-0			

CE CB ENEC KEMA TUV

Rated connection	
0.5...10 / 1.5...6	
0.5...6 / 0.5...6	

13 / 0.8 x 4.0 mm

Note

Ordering data

Version	
With socket	
without socket	

Note

Accessories

Plug-in cross-connection	
2-pole	
3-pole	
4-pole	
End plate / Partition plate	
End plate	
Testing / Checking	
Test plug	
Socket - yellow	
Socket - green	
Socket - magenta	
Socket - blue	
Miscellaneous accessories	
Lockout device	
Short-circuit plug, 2-pole	
Short-circuit plug, 3-pole	
Short-circuit plug, 4-pole	
Marker holder	
Marking tags	

Type	Qty.	Order No.
ZTD 6/STB	20	1771960000
ZTD 6	20	1771810000

Type	Qty.	Order No.
ZQV 6/2 GE	41 A 60	1627850000
ZQV 6/3 GE	41 A 60	1627860000
ZQV 6/4 GE	41 A 60	1627870000
ZTW ZTL6	20	1771870000
PS 4 F.STB 4	20	0299600000
STB 21.6/IH/GE WTL6/3	50	1071010000
STB 21.6/IH/GN WTL6/3	50	1071020000
STB 21.6/IH/VI WTL6/3	50	1071030000
STB 21.6/IH/BL WTL6/3	50	1071080000
KSBR/2 ZTL6	10 A 20	1771820000
KSBR/3 ZTL6	10 A 20	1771830000
KSBR/4 ZTL6	10 A 20	1771840000
BZT ZTL6	20	1781140000
DEK 5/8 MC NE WS	800	1856740000
WS 12/6.5 MC NE WS	540	1609920000

For detailed information on other accessories and application in the online catalogue

ZTL 6

6 mm²

Disconnect test terminal

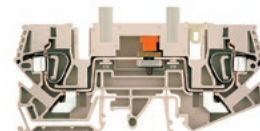

8 x 106 x 46.5
52 / 10
0.5...10

IEC 60947-7-1

IEC	UL	CSA	EN 60079-7
400	300	300	
41	33	33	
6	AWG 20...8	AWG 20...8	
8 kV / 3			
A5 / V-0			

CE CB ENEC KEMA TUV

Rated connection	
0.5...10 / 1.5...6	
0.5...6 / 0.5...6	

13 / 0.8 x 4.0 mm

Note

Ordering data

Type	Qty.	Order No.
ZTL 6/STB	20	1771950000
ZTL 6	20	1771800000

Type	Qty.	Order No.
ZQV 6/2 GE	41 A 60	1627850000
ZQV 6/3 GE	41 A 60	1627860000
ZQV 6/4 GE	41 A 60	1627870000
ZTW ZTL6	20	1771870000
PS 4 F.STB 4	20	0299600000
STB 21.6/IH/GE WTL6/3	50	1071010000
STB 21.6/IH/GN WTL6/3	50	1071020000
STB 21.6/IH/VI WTL6/3	50	1071030000
STB 21.6/IH/BL WTL6/3	50	1071080000
SSP ZTL6	100	1771860000
KSBR/2 ZTL6	10 A 20	1771820000
KSBR/3 ZTL6	10 A 20	1771830000
KSBR/4 ZTL6	10 A 20	1771840000
BZT ZTL6	20	1781140000
DEK 5/8 MC NE WS	800	1856740000
WS 12/6.5 MC NE WS	540	1609920000

For detailed information on other accessories and application in the online catalogue



Instrument transformer wiring
Screw connection



WTL 4

4 mm²

WTL 4/2

4 mm²

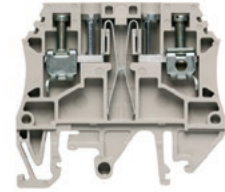
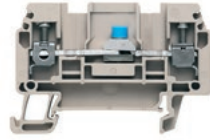

Width/Height/Depth	mm
max. current / max. cond. cross-section	A
Max. clamping range	mm ²

6.1 x 61.3 x 39.9
41 / 6
0.13...6



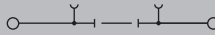

6 x 56.5 x 48.5
11 / 6
0.13...6



Technical data

Rated data	
Rated voltage	V
Rated current	A
for wire cross-section	mm ²
Rated impulse withstand voltage / Pollution severity	
Gauge to IEC 60947-1 / UL 94 flammability rating	
Approvals	
Clamped conductors (H05V/H07V)	
Solid / Stranded	mm ²
Flexible / Flexible with ferrule	mm ²
Tightening torque / Clamping screw	Nm
Tightening torque Separating screw	Nm
Stripping length / Blade size	mm/-
Note	

IEC	UL	CSA	EN 60079-7
500	300	300	
32	28	28	
4	AWG 26...10	AWG 26...10	
6 kV / 3			
A3 / V-0			
			
Rated connection			
0.5...6 / 1.5...4			
0.5...4 / 0.5...4			
0.4...0.7 / (M 2.5)			
0.5...0.7			
10 / 0.6 x 3.5 mm			
Note			

IEC	UL	CSA	EN 60079-7
500	300	150	
10	8	8	
4	AWG 26...10	AWG 26...10	
6 kV / 3			
A4 / V-0			
			
Rated connection			
0.5...6 / 1.5...6			
0.5...6			
0.5...0.8 / (M 3)			
10 / 0.6 x 3.5 mm			
Note			

Ordering data

Version	
	With socket
	without socket
Note	

Type	Qty.	Order No.
WTL 4/STB	50	1754970000
WTL 4	50	1754960000
Note		

Type	Qty.	Order No.
WTL 4/2 STB	50	1881650000
Note		

Accessories

Screwable cross-connection	
	2-pole
	3-pole
	4-pole
	10-pole
End plate / Partition plate	
	dark beige
End bracket	
	dark beige
Cross-connection slider	
	2-pole
	Mounting screw for QVS
Testing / Checking	
	Test plug
	Socket
	Standard
Marking tags	

Type	Qty.	Order No.
WQV 4/2	41 A 50	1051960000
WQV 4/3	41 A 50	1054560000
WQV 4/4	41 A 50	1054660000
WQV 4/10	41 A 20	1052060000
ZAP/TW 1	50	1608740000
WEW 35/2	50	1061200000
QVS 2/4 SAKT4	32 A 20	1319260000
BFSC M3X22 SAKT4	50	1319900000
PS 2.3 RT	20 mA 20	0180400000
STB 8.5/5/2.3/M3 SAK2.5	50	0280600000
DEK 5/6 MC NE WS	1000	1609820000
Note		

Type	Qty.	Order No.
WAP WTL4/2	50	1881640000
WEW 35/2	50	1061200000
WTA 8 TN	6 A 25	1915450000
WS 12/6 MC NE WS	600	1609900000
Note		

For detailed information on other accessories and application in the online catalogue



Test-disconnect terminal blocks

WTL 6 STB

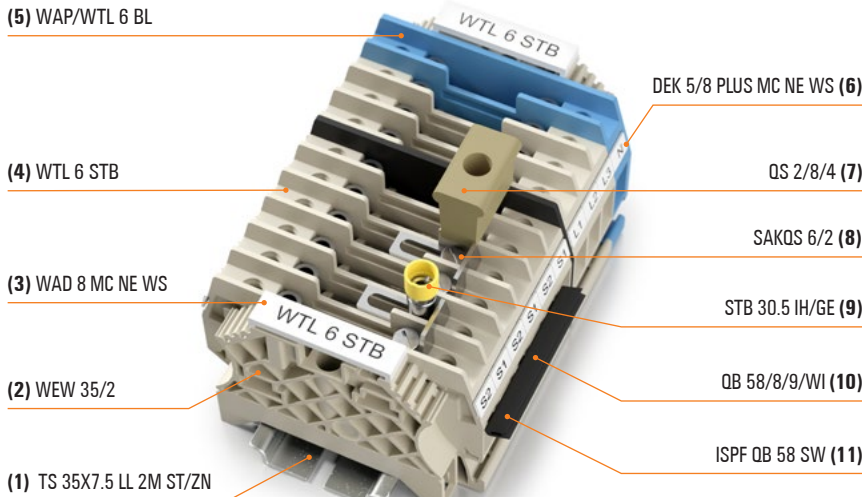

Ordering data

Pos.	Description	Type	Dimensions	Color	Order No.	Qty.
1	Mounting rail	TS 35X7.5 LL 2M/ST/ZN	35 x 7.5 x 2000 mm	silver	0514500000	2
2	End bracket	WEW 35/2	6 x 52.6 x 36.5 mm	beige*	1061200000	100
3	Group marker	WAD 8 MC NE WS	8 x 11.7 x 33.3 mm	white	1112940000	48
4	Instrument transformer wiring terminal block	WTL 6 STB	8.1 x 69 x 100 mm	beige*	2863880000	50
	Instrument transformer wiring terminal block	WTL 6 STB BL	8.1 x 69 x 100 mm	beige*	2863890000	50
	Instrument transformer wiring terminal block	WTL 6 STB SW	8.1 x 69 x 100 mm	beige*	2863900000	50
	Instrument transformer wiring terminal block	WTL 6 STB GR	8.1 x 69 x 100 mm	beige*	2863910000	50
5	End plate	WAP/WTL 6 BL	2.1 x 34 x 61 mm	blue	2863970000	20
	End plate	WAP/WTL 6	2.1 x 34 x 61 mm	beige	2863960000	20
	End plate	WAP/WTL 6 SW	2.1 x 34 x 61 mm	black	2868510000	20
	End plate	WAP/WTL 6 GR	2.1 x 34 x 61 mm	light grey	2868500000	20
	Partition plate	WTW WTL 6/1 4MM	1.5 x 65 x 44.5 mm	dark beige	1766900000	20
6	Terminal block marker	DEK 5/8 PLUS MC NE WS	8 x 2.2 x 5 mm	white	1046350000	800
7	Short circuit bridge (pluggable)	2-pole QS 2/8/4	16 x 12 x 34.5 mm	silver	2709600000	20
8	Short circuit bridge (screwable with slider)	2-pole SAKQS 6/2		silver	2111240000	10
	Short circuit bridge (screwable with slider)	4-pole SAKQS 6/4		silver	2111670000	10
9	Test plug	STB 30.5 IH/GE	7.2 x 7.2 x 31.7 mm	yellow	0341500000	50
	Test plug	STB 30.5 IH/SW	7.2 x 7.2 x 31.7 mm	black	0341000000	50
	Test plug	STB 30.5 IH/GR	7.2 x 7.2 x 31.7 mm	light grey	0341100000	50
	Test plug	STB 30.5 IH/BL	7.2 x 7.2 x 31.7 mm	blue	0341200000	50
	Test plug	STB 30.5 IH/RT	7.2 x 7.2 x 31.7 mm	red	0341300000	50
	Test plug	STB 30.5 IH/GN	7.2 x 7.2 x 31.7 mm	green	0341400000	50
	Test plug	STB 30.5 IH/VI	7.2 x 7.2 x 31.7 mm	violet	0341600000	50
	Test plug	STB 30.5 IH/BR	7.2 x 7.2 x 31.7 mm	brown	1027870000	50
10	Cross-connection - straight 58-pole	QB 58/8/15	458.5 x 0.8 x 17.5 mm	silver	0545400000	10
10	Cross-connection - angled 58-pole	QB 58/8/9/WI	458.5 x 0.8 x 17.5 mm	silver	0545300000	10
11	Insulation profile (black) 58-pole	ISPF QB 58 SW	465 x 5.7 x 2.5 mm	black	0546000000	10
	Short circuit bridge (screwable and fixed) 2-pole	SAKQB 6/2		silver	2615330000	20
	Short circuit bridge (screwable and fixed) 3-pole	SAKQB 6/3		silver	2615340000	20
	Short circuit bridge (screwable and fixed) 4-pole	SAKQB 6/4		silver	2615360000	20
	Short circuit bridge (screwable and fixed) 10-pole	SAKQB 6/10		silver	2111230000	10
	Test plug	PS 4 F.STB 4	7.7 x 7.7 x 42 mm	red	0299600000	20

* More color variants in our online catalog

WTL 6 STB

6 mm²

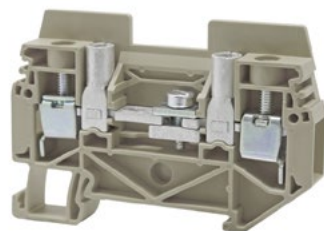

Width/Height/Depth	mm
max. current / max. cond. cross-section	A
Max. clamping range	mm ²

7.9 x 69 x 46.5

41 / 10

0.5...10

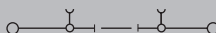

Technical data

Rated data	
Rated voltage	V
Rated current	A
for wire cross-section	mm ²
Rated impulse withstand voltage / Pollution severity	
Gauge to IEC 60947-1 / UL 94 flammability rating	
Approvals	
Clamped conductors (H05V/H07V)	
Solid / Stranded	mm ²
Flexible / Flexible with ferrule	mm ²
Tightening torque / Clamping screw	Nm
Tightening torque Separating screw	Nm
Stripping length / Blade size	mm/-

IEC 60947-7-1

IEC	UL	CSA	EN 60079-7
500	150		
41	30		
6	AWG 20...8		
6 kV / 3			
A5 / V-0			

CE

Rated connection	
0.5...10 / 0.5...10	
0.5...6 / 0.5...6	
0.8...1.2 / (M 3.5)	
0.5...0.8	
12 / 0.8 x 4.0 mm	

Note

Ordering data

Version	
	dark beige
	Blue
	Black
	light grey

Note

Type	Qty.	Order No.
WTL 6 STB	50	2863880000
WTL 6 STB BL	50	2863890000
WTL 6 STB SW	50	2863900000
WTL 6 STB GR	50	2863910000

Accessories

Short circuit bridge (screwable with slider)	
	2-pole
	4-pole
Short circuit bridge (screwable and fixed)	
	2-pole
	4-pole
Short circuit bridge (pluggable)	
	2-pole
Cross-connector	
	58-pole, straight
	58-pole, angled
	58-pole, Isolation profile (black)
Test socket	
	yellow
	green
	violet
	blue
End plate	
	dark beige
	blue
	Black
	green
End bracket	
	dark beige
Screwdriver	
	Standard
Marking tags	
For detailed information on other accessories and application in the online catalogue	

Type	Qty.	Order No.	
SAQSS 6/2	10	2111240000	
SAQSS 6/4	10	21111670000	
SAQSB 6/2	20	2615330000	
SAQSB 6/4	20	2615360000	
QS 2/8/4	44 A	20	0270960000
QB 58/8/15	27 A	10	0545400000
QB 58/8/9/WI	27 A	10	0545300000
ISPF QB58 SW	10	0546000000	
STB 30.5 IH/GE	50	0341500000	
STB 30.5 IH/GN	50	0341400000	
STB 30.5 IH/VI	50	0341600000	
STB 30.5 IH/BL	50	0341200000	
WAP WTL 6	20	2863960000	
WAP WTL 6 BL	20	2863970000	
WAP WTL 6 SW	20	2868510000	
WAP WTL 6 GR	20	2868500000	
WEW 35/2	50	1061200000	
SDS 0.8X4.0X100	1	2749360000	
DEK 5/8 PLUS MC NE WS	800	1046350000	



Instrument transformer wiring
Screw connection

Test-disconnect terminal blocks

WTL 6/1, WTD 6/1, WTQ 6/1

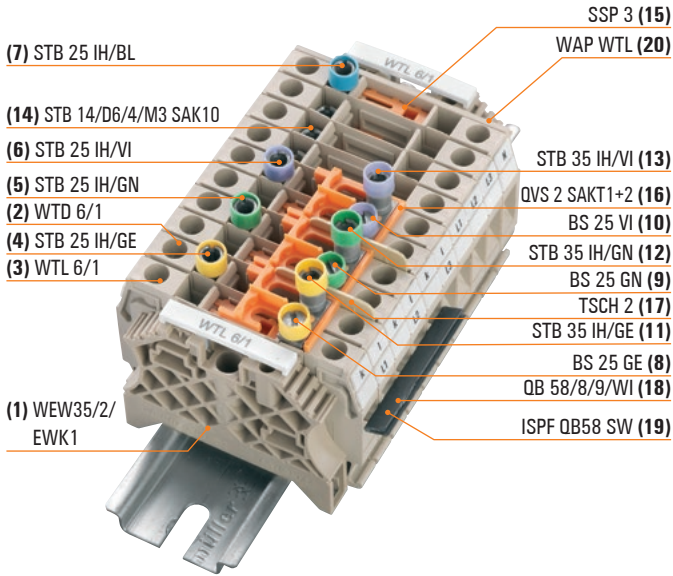

B



Ordering data

Pos.	Type	Order No.	Qty.
1	WEW35/2/EWK1	1061200000	2
2	WTD 6/1	1017100000	3
3	WTL 6/1	1016700000	7
4	STB 25 IH/GE	0267200000	1
5	STB 25 IH/GN	0271200000	1
6	STB 25 IH/VI	0271300000	1
7	STB 25 IH/BL	0343400000	1
8	BS 25 GE	0335700000	1
9	BS 25 GN	0335600000	1
10	BS 25 VI	0335800000	1
11	STB 35 IH/GE	0389000000	1
12	STB 35 IH/GN	0388900000	1
13	STB 35 IH/VI	0389100000	1
14	STB 14/D6/4/M3 SAK10	0169900000	3
15	SSP 3	0531760000	4
16	QVS 2 SAKT1+2	0307300000	3
17	TSCH 2	0353660000	2
18	QB 58/8/9/WI	0545300000	1
19	ISPF QB58 SW	0546000000	1
20	WAP WTL	1068300000	1
21	VH 19	0318000000	10

Additionally available for a shared k-point:

Pos.	Type	Order No.	Order No.	Qty.
18	QB 58°angled	0545300000	0545300000	1
19	ISPFQB58SW*	0546000000	0546000000	1

* Shorten to 5 poles



WTL 6/1

6 mm²

Longitudinal - disconnecter



7.9 x 65 x 47.5
57 / 10
0.5...10

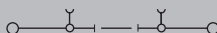

WTD 6/1

6 mm²

Feed-through

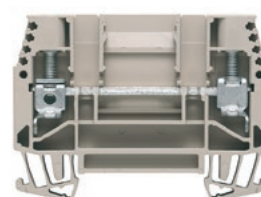

7.9 x 65 x 47.5
57 / 10
0.5...10



Width/Height/Depth	mm
max. current / max. cond. cross-section	A
Max. clamping range	mm ²

Technical data

Rated data	
Rated voltage	V
Rated current	A
for wire cross-section	mm ²
Rated impulse withstand voltage / Pollution severity	
Gauge to IEC 60947-1 / UL 94 flammability rating	
Approvals	
Clamped conductors (H05V/H07V)	
Solid / Stranded	mm ²
Flexible / Flexible with ferrule	mm ²
Tightening torque / Clamping screw	Nm
Tightening torque Separating screw	Nm
Stripping length / Blade size	mm/-

Note

Ordering data

Version	
With socket	
without socket	
Note	

Accessories

Screwable cross-connection	
2-pole	
3-pole	
4-pole	
10-pole	
Connecting sleeve	
Mounting screw	
End plate / Partition plate	
dark beige	
dark beige	
Cross-connection slider	
2-pole	
3-pole	
Connecting sleeve for QVS	
4-pole	
Testing / Checking	
Socket - blue	
Socket - green	
Socket - yellow	
Socket - magenta	
Test plug	
Marking tags	
DEK 5/8 MC NE WS	
WS 12/6.5 MC NE WS	
Miscellaneous accessories	
Lockout device	

For detailed information on other accessories and application in the online catalogue

IEC	UL	CSA	EN 60079-7
630	300	300	
41	45	45	
6	AWG 20...8	AWG 20...8	
6 kV / 3			
A5 / V-0			
CE			
Rated connection			
0.5...10 / 1.5...10			
0.5...10 / 0.5...6			
1...1.6 / (M 3.5)			
0.5...0.7			
12 / 0.8 x 4.0 mm			

Type	Qty.	Order No.
WTL 6/1/STB	50	1016900000
WTL 6/1	50	1016700000

Type	Qty.	Order No.
QL 2 SAK6N	41 A 50	0194300000
QL 3 SAK6N	41 A 50	0194400000
QL 4 SAK6N	57 A 50	0194500000
QL 10 SAK6N	41 A 20	0338300000
VH 12/4.9/3.3 SAK6N	100	0249000000
KISC M3X20 SAK10 CU5	100	0377100000
WAP WTL6/1	20	1068300000
WTW WTL6/1 DB	20	1068400000
QVS 2 SAKT1+2	41 A 20	0307300000
QVS 3 SAKT1+2	41 A 20	0329300000
VH 19/6/4.2 SAKT1	50	0318000000
STB 35 IH/BL	50	0388700000
STB 35 IH/GN	50	0388900000
STB 35 IH/GE	50	0389000000
STB 35 IH/VI	50	0389100000
DEK 5/8 MC NE WS	800	1856740000
WS 12/6.5 MC NE WS	540	1609920000

IEC	UL	CSA	EN 60079-7
630	300	300	
41	45	50	
6	AWG 20...8	AWG 20...8	
6 kV / 3			
A5 / V-0			
CE			
Rated connection			
0.5...10 / 1.5...10			
0.5...10 / 0.5...6			
1...1.6 / (M 3.5)			
12 / 0.8 x 4.0 mm			

Type	Qty.	Order No.
WTD 6/1	50	1017100000

Type	Qty.	Order No.
QL 2 SAK6N	41 A 50	0194300000
QL 3 SAK6N	41 A 50	0194400000
QL 4 SAK6N	57 A 50	0194500000
QL 10 SAK6N	41 A 20	0338300000
VH 12/4.9/3.3 SAK6N	100	0249000000
KISC M3X20 SAK10 CU5	100	0377100000
WAP WTL6/1	20	1068300000
WTW WTL6/1 DB	20	1068400000
QVS 2 SAKT1+2	41 A 20	0307300000
QVS 3 SAKT1+2	41 A 20	0329300000
VH 19/6/4.2 SAKT1	50	0318000000
STB 35 IH/BL	50	0388700000
STB 35 IH/GN	50	0388900000
STB 35 IH/GE	50	0389000000
STB 35 IH/VI	50	0389100000
DEK 5/8 MC NE WS	800	1856740000
WS 12/6.5 MC NE WS	540	1609920000



Instrument transformer wiring
Screw connection



WTQ 6/1

6 mm²

Cross-connect/disconnect (isolator)



Width/Height/Depth	mm
max. current / max. cond. cross-section	A
Max. clamping range	mm ²

7.9 x 65 x 47.5
57 / 10
0.5...10

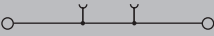

Technical data

Rated data	
Rated voltage	V
Rated current	A
for wire cross-section	mm ²
Rated impulse withstand voltage / Pollution severity	
Gauge to IEC 60947-1 / UL 94 flammability rating	
Approvals	
Clamped conductors (H05V/H07V)	
Solid / Stranded	mm ²
Flexible / Flexible with ferrule	mm ²
Tightening torque / Clamping screw	Nm
Tightening torque Separating screw	-
Stripping length / Blade size	mm/-

IEC	UL	CSA	EN 60079-7
500	300	300	
41	45	50	
6	AWG 20...8	AWG 20...8	
6 kV / 3			
A5 / V-0			

CE

Rated connection	
0.5...10 / 1.5...10	
0.5...10 / 0.5...6	
1...1.6 / (M 3.5)	
12 / 0.8 x 4.0 mm	

Note

Ordering data

Version	With socket without socket
Note	

Type	Qty.	Order No.
WTQ 6/1/STB	50	1018100000
WTQ 6/1	50	1017900000

Accessories

Screwable cross-connection	
	2-pole
	3-pole
	4-pole
	10-pole
	Connecting sleeve
	Mounting screw
End plate / Partition plate	
	dark beige
	dark beige
Cross-connection slider	
	2-pole
	3-pole
	Connecting sleeve for QVS
	4-pole
Testing / Checking	
	Socket - blue
	Socket - green
	Socket - yellow
	Socket - magenta
	Test plug
Marking tags	
Miscellaneous accessories	
	Lockout device

Type	Qty.	Order No.
WQV 6/2	57 A 50	1052360000
WQV 6/3	57 A 50	1054760000
WQV 6/4	57 A 50	1054860000
WQV 6/10	57 A 20	1052260000
VH 12/4.9/3.3 SAK6N	100	0249000000
KISC M3X20 SAK10 CU5	100	0377100000
WAP WTL6/1	20	1068300000
WTW WTL6/1 DB	20	1068400000
QVS 2 SAKT1+2	41 A 20	0307300000
QVS 3 SAKT1+2	41 A 20	0329300000
VH 19/6/4.2 SAKT1	50	0318000000
WKB 1/4	41 A 50	1604320000
STB 35 IH/BL	50	0388700000
STB 35 IH/GN	50	0388900000
STB 35 IH/GE	50	0389000000
STB 35 IH/VI	50	0389100000
PS 4 F.STB 4	20	0299600000
DEK 5/8 MC NE WS	800	1856740000
WS 12/6.5 MC NE WS	540	1609920000
SSP 3 SAKT1	100	0531760000

For detailed information on other accessories and application in the online catalogue



Instrument transformer wiring
Screw connection

Test-disconnect terminal blocks

WTL 6/1 EN, WTD 6/1 EN, WTQ 6/1 EN

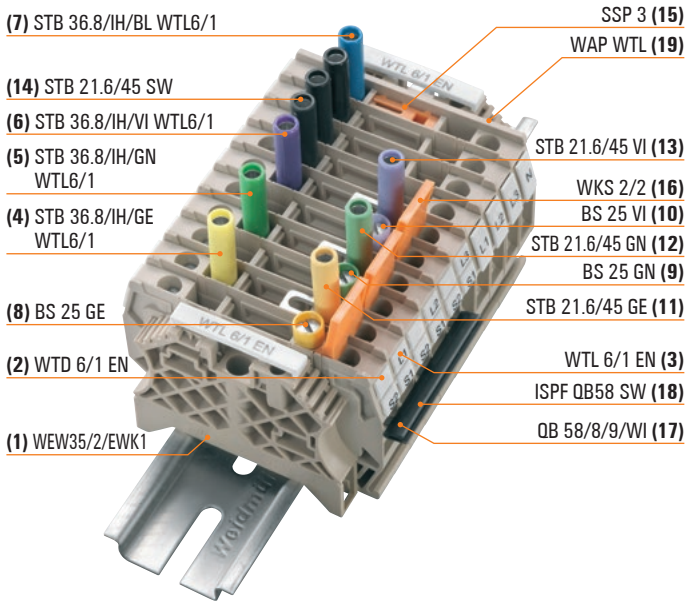

B



Ordering data

Pos.	Type	Order No.	Order No.	Qty.
1	WEW35/2/EWK1	1061200000	0206160000	2
2	WTD 6/1 EN	1934830000	1934830000	3
3	WTL 6/1 EN	1934810000	1934810000	7
4	STB 36.8/IH/GE WTL6/1	1847760000	1847760000	1
5	STB 36.8/IH/GN WTL6/1	1847770000	1847770000	1
6	STB 36.8/IH/VI WTL6/1	1847780000	1847780000	1
7	STB 36.8/IH/BL WTL6/1	1847790000	1847790000	1
8	BS 25 GE	0335700000	0335700000	1
9	BS 25 GN	0335600000	0335600000	1
10	BS 25 VI	0335800000	0335800000	1
11	STB 21.6/45 GE	1936240000	1936240000	2
12	STB 21.6/45 GN	1936250000	1936250000	2
13	STB 21.6/45 VI	1936260000	1936260000	2
14	STB 21.6/45 SW	1936270000	1936270000	2
15	SSP 3	0531760000	0531760000	7
16	WKS 2/2	1936140000	1936140000	3
17	QB 58/8/9/WI	0545300000	0545300000	1
18	ISPF QB58 SW	0546000000	0546000000	1
19	WAP WTL	1957710000	1957710000	1
20	VH 16	0309700000	0309700000	9

Additionally available for a shared k-point:

Pos.	Type	Order No.	Order No.	Qty.
17	QB 58*angled	0545300000	0545300000	1
18	ISPFQB58SW*	0546000000	0546000000	1

* Shorten to 5 poles



WTL 6/1 EN

6 mm²

Longitudinal - disconnecter

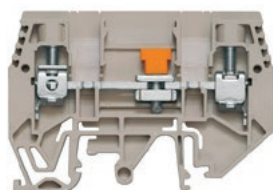

7.9 x 68.5 x 47.5
57 / 10
0.5...10

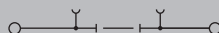

WTD 6/1 EN

6 mm²

Feed-through (bushing)

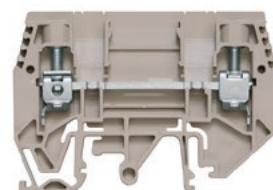

7.9 x 65 x 47.5
57 / 10
0.5...10

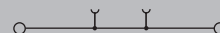

Width/Height/Depth	mm
max. current / max. cond. cross-section	A
Max. clamping range	mm ²

Technical data

Rated data	
Rated voltage	V
Rated current	A
for wire cross-section	mm ²
Rated impulse withstand voltage / Pollution severity	
Gauge to IEC 60947-1 / UL 94 flammability rating	
Approvals	
Clamped conductors (H05V/H07V)	
Solid / Stranded	mm ²
Flexible / Flexible with ferrule	mm ²
Tightening torque / Clamping screw	Nm
Tightening torque Separating screw	Nm
Stripping length / Blade size	mm/-

Note

Ordering data

Version	
	With socket
	without socket
Note	

Accessories

Screwable cross-connection	
	2-pole
	3-pole
	4-pole
	10-pole
End plate / Partition plate	
	dark beige
	dark beige
End bracket	
	dark beige
Cross-connection slider	
	2-pole
	3-pole
	4-pole
	Connecting sleeve for QVS
Testing / Checking	
	Socket - blue
	Socket - yellow
	Socket - green
	Socket
	Socket - blue
	Socket - yellow
	Socket - green
Miscellaneous accessories	
	Lockout device
Marking tags	

For detailed information on other accessories and application in the online catalogue

IEC	UL	CSA	EN 60079-7
630	300	300	
41	45	45	
6	AWG 20...8	AWG 20...8	
6 kV / 3			
A5 / V-0			
CE CB IEC VDE			
Rated connection			
0.5...10 / 1.5...10			
0.5...10 / 0.5...6			
1...1.6 / (M 3.5)			
0.5...0.7			
12 / 0.8 x 4.0 mm			

Type	Qty.	Order No.
WTL 6/1 EN STB	50	1934820000
WTL 6/1 EN	50	1934810000

Type	Qty.	Order No.
WQV 6/2	57 A 50	1052360000
WQV 6/3	57 A 50	1054760000
WQV 6/4	57 A 50	1054860000
WQV 6/10	57 A 20	1052260000
WAP WTL6/1 EN	20	1957710000
WTW WTL6/1 DB	20	1068400000
WEW 35/2	50	1061200000
WKS 2/2	41 A 50	1936140000
WKS 2/3	41 A 50	1936150000
WKS 2/4	41 A 50	1936160000
VH 16/5/3.5 SAK10-35	50	0309700000
STB 21.6/45 BL	50	1936290000
STB 21.6/45 GE	50	1936240000
STB 21.6/45 GN	50	1936250000
STB 14/D6/4/M3 SAK10	500	2012420000
STB 36.8/IH/BL WTL6/1	50	1847790000
STB 36.8/IH/GE WTL6/1	50	1847760000
STB 36.8/IH/GN WTL6/1	50	1847770000
DEK 5/8 MC NE WS	800	1856740000
WS 12/8 PLUS MC NE WS	420	1906000000

IEC	UL	CSA	EN 60079-7
630	300	300	
41	45	45	
6	AWG 20...8	AWG 20...8	
6 kV / 3			
A5 / V-0			
CE CB IEC VDE			
Rated connection			
0.5...10 / 1.5...10			
0.5...10 / 0.5...6			
0.8...1.6 / (M 3.5)			
12 / 0.8 x 4.0 mm			

Type	Qty.	Order No.
WTD 6/1 EN	50	1934830000

Type	Qty.	Order No.
WQV 6/2	57 A 50	1052360000
WQV 6/3	57 A 50	1054760000
WQV 6/4	57 A 50	1054860000
WQV 6/10	57 A 20	1052260000
WAP WTL6/1 EN	20	1957710000
WTW WTL6/1 DB	20	1068400000
WEW 35/2	50	1061200000
WKS 2/2	41 A 50	1936140000
WKS 2/3	41 A 50	1936150000
WKS 2/4	41 A 50	1936160000
VH 16/5/3.5 SAK10-35	50	0309700000
STB 21.6/45 BL	50	1936290000
STB 21.6/45 GE	50	1936240000
STB 21.6/45 GN	50	1936250000
STB 14/D6/4/M3 SAK10	500	2012420000
STB 36.8/IH/BL WTL6/1	50	1847790000
STB 36.8/IH/GE WTL6/1	50	1847760000
STB 36.8/IH/GN WTL6/1	50	1847770000
DEK 5/8 MC NE WS	800	1856740000
WS 12/8 PLUS MC NE WS	420	1906000000



Instrument transformer wiring
Screw connection



WTQ 6/1 EN

6 mm²

Cross-connect/disconnect (isolator)

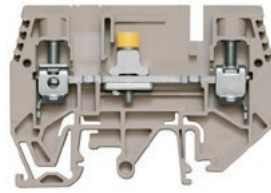

Width/Height/Depth	mm
max. current / max. cond. cross-section	A
Max. clamping range	mm ²

7.9 x 65 x 47.5
57 / 10
0.5...10



Technical data

Rated data	
Rated voltage	V
Rated current	A
for wire cross-section	mm ²
Rated impulse withstand voltage / Pollution severity	
Gauge to IEC 60947-1 / UL 94 flammability rating	
Approvals	
Clamped conductors (H05V/H07V)	
Solid / Stranded	mm ²
Flexible / Flexible with ferrule	mm ²
Tightening torque / Clamping screw	-
Tightening torque Separating screw	-
Stripping length / Blade size	mm/-

IEC	UL	CSA	EN 60079-7
500	300	300	
41	45	45	
6	AWG 20...8	AWG 20...8	
6 kV / 3			
A5 / V-0			

CE

Rated connection	
0.5...10 / 1.5...10	
0.5...10 / 0.5...6	
/ (M 3.5)	
12 / 0.8 x 4.0 mm	

Note

Ordering data

Version	With socket
	without socket
Note	

Type	Qty.	Order No.
WTQ 6/1 EN STB	50	1934800000
WTQ 6/1 EN	50	1934790000

Accessories

Screwable cross-connection	
	2-pole
	3-pole
	4-pole
	10-pole
End plate / Partition plate	
	dark beige
	dark beige
End bracket	
	dark beige
Cross-connection slider	
	2-pole
	3-pole
	4-pole
	Connecting sleeve for QVS
Testing / Checking	
	Socket - blue
	Socket - yellow
	Socket - green
	Socket
	Socket - blue
	Socket - yellow
	Socket - green
Miscellaneous accessories	
	Lockout device
Marking tags	

Type	Qty.	Order No.
WQV 6/2	57 A 50	1052360000
WQV 6/3	57 A 50	1054760000
WQV 6/4	57 A 50	1054860000
WQV 6/10	57 A 20	1052260000
WAP WTL6/1 EN	20	1957710000
WTW WTL6/1 DB	20	1068400000
WEW 35/2	50	1061200000
WKS 2/2	41 A 50	1936140000
WKS 2/3	41 A 50	1936150000
WKS 2/4	41 A 50	1936160000
VH 16/5/3.5 SAK10-35	50	0309700000
STB 21.6/45 BL	50	1936290000
STB 21.6/45 GE	50	1936240000
STB 21.6/45 GN	50	1936250000
STB 14/D6/4/M3 SAK10	500	2012420000
STB 36.8/IH/BL WTL6/1	50	1847790000
STB 36.8/IH/GE WTL6/1	50	1847760000
STB 36.8/IH/GN WTL6/1	50	1847770000
DEK 5/8 MC NE WS	800	1856740000
WS 12/8 PLUS MC NE WS	420	1906000000

For detailed information on other accessories and application in the online catalogue





WTL 6/1/STB/TNSC/EN

6 mm²

Longitudinal separator

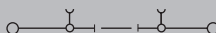
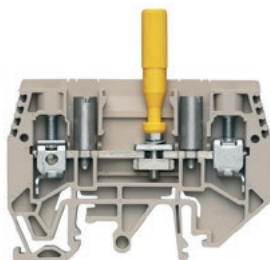

Width/Height/Depth	mm
max. current / max. cond. cross-section	A
Max. clamping range	mm ²

7.9 x 65 x 66
57 / 10
0.5...10

Technical data

Rated data	
Rated voltage	V
Rated current	A
for wire cross-section	mm ²
Rated impulse withstand voltage / Pollution severity	
Gauge to IEC 60947-1 / UL 94 flammability rating	
Approvals	
Clamped conductors (H05V/H07V)	
Solid / Stranded	mm ²
Flexible / Flexible with ferrule	mm ²
Tightening torque / Clamping screw	Nm
Tightening torque Separating screw	Nm
Stripping length / Blade size	mm/-

IEC	UL	CSA	EN 60079-7
630			
41			
6			
	6 kV / 3		
	A5 / V-0		
CE			
Rated connection			
0.5...10 / 1.5...			
0.5...10 / 0.5...6			
1...1.6 / (M 3.5)			
0.5...0.6			
12 / 0.8 x 4.0 mm			

Note

Ordering data

Version	
	With socket
	without socket
Note	

Type	Qty.	Order No.
WTL 6/1/STB/TNSC/EN	50	1938820000
WTL 6/1/TNSC/EN	50	1345280000

Accessories

Screwable cross-connection	
	2-pole
	3-pole
	4-pole
	10-pole
End plate / Partition plate	
	dark beige
	dark beige
End bracket	
	dark beige
Cross-connection slider	
	2-pole
	3-pole
	4-pole
	Connecting sleeve for QVS
Testing / Checking	
	Socket - blue
	Socket - yellow
	Socket - green
	Socket
Miscellaneous accessories	
	Lockout device
Marking tags	

Type	Qty.	Order No.
WQV 6/2	57 A 50	1052360000
WQV 6/3	57 A 50	1054760000
WQV 6/4	57 A 50	1054860000
WQV 6/10	57 A 20	1052260000
WAP WTL6/1 EN	20	1957710000
WTW WTL6/1 DB	20	1068400000
WEW 35/2	50	1061200000
WKS 2/2	41 A 50	1936140000
WKS 2/3	41 A 50	1936150000
WKS 2/4	41 A 50	1936160000
VH 16/5/3.5 SAK10-35	50	0309700000
STB 21.6/45 BL	50	1936290000
STB 21.6/45 GE	50	1936240000
STB 21.6/45 GN	50	1936250000
STB 14/D6/4/M3 SAK10	500	2012420000
DEK 5/8 MC NE WS	800	1856740000
WS 12/8 PLUS MC NE WS	420	1906000000

For detailed information on other accessories and application in the online catalogue

Instrument transformer wiring
Screw connection – accessories

Accessories for test-disconnect terminals WTL 6/1

Technical data

Rated voltage	
for neighbouring	rated voltage
QVS	63 V
WQV	bis 400 V
QL	250 V

for neighbouring		rated voltage	
Type	Qty.	Order No.	
STB 25			63 V
STB 30.5			63 V
STB 35			63 V

SSP WTL, SSP 3 and **SSP 4** prevent unwanted opening or closing of current circuits. They block the disconnecting slider in its particular position. The lockout device is easily pressed into the terminal, but can only be removed again with a tool.

Type	Qty.	Order No.
SSP 3	100	0531760000
SSP WTL	100	1604200000

QVS 1

Cross-connection slider



QVS QVS QVSK 2 QVS 2S

Type	No. of poles	Qty.	Order No.
QVS 2	2	20	0307300000
QVSK 2	2	20	1670360000
QVS 3	3	20	0329300000
QVS 4	4	20	0307400000
QVS 2S	2	20	0358460000

Note:
 Not suitable for WTL 6/1 EN.
 QVS 2 placed opposite each other cannot be switched.

STB

Cross-connection slider



Type	Colour	Qty.	Order No.
STB 14		50	0169900000
STB 30,5			
STB 30.5	black	50	0341000000
STB 30.5	grey	50	0341100000
STB 30.5	blue	50	0341200000
STB 30.5	red	50	0341300000
STB 30.5	green	50	0341400000
STB 30.5	yellow	50	0341500000
STB 30.5	violet	50	0341600000
STB 35			
STB 35	yellow	50	0389000000
STB 35	green	50	0388900000
STB 35	violet	50	0389100000
STB 35	black	50	0388500000
STB 35	grey	50	0388600000
STB 35	blue	50	0388700000
STB 35	red	50	0388800000
Connecting sleeves			
VH19		50	0318000000

To retain the rated voltage, partition plates TW or partition discs TSch have to be used, except with WQV.



QVSK 2
(167036)

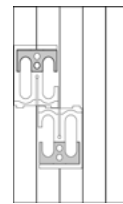

WTL6/1, WTD6/1

QVS 2
(030730)

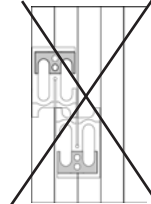

WTL6/1, WTD6/1

Accessories for test-disconnect terminals WTL 6/1 EN

BS / VH



Type	Colour	Qty.	Order No.
Fixing screws			
BS 25	yellow	50	0335700000
BS 25	green	50	0335600000
BS 25	violet	50	0335800000
BS 25	grey	50	0335300000
BS 25	black	50	0335200000
BS 25	blue	50	0335400000
BS 25	red	50	0335500000
BS 25	blank	50	0334700000
STB 25			
STB 21.6/45 BL	blue	50	1936290000
STB 21.6/45 DB	d.blue	50	1938790000
STB 21.6/45 GE	yellow	50	1936240000
STB 21.6/45 GN	green	50	1936250000
STB 21.6/45 GR	grey	50	1936280000
STB 21.6/45 RT	red	50	1936300000
STB 21.6/45 SW	black	50	1936270000
STB 21.6/45 VI	violet	50	1936260000
Connecting sleeves			
VH 16/5/3.5 SAK10-35		50	0309700000
CuZn 39 (brass alloy)			
STB 36.8			
STB 36.8/IH/DB WTL6/1		50	1847740000
STB 36.8/IH/GE WTL6/1		50	1847760000
STB 36.8/IH/GN WTL6/1		50	1847770000
STB 36.8/IH/VI WTL6/1		50	1847780000
STB 36.8/IH/BL WTL6/1		50	1847790000

WQV / QL



WQV (only for WTL 6/2, WTL 6/3)

Type	No. of poles	Qty.	Order No.
WQV			
WQV 6/2	2	50	1052360000
WQV 6/3	3	50	1054760000
WQV 6/4	4	50	1054860000
WQV 6/5	5	50	1062660000
WQV 6/7	7	50	1062680000
WQV 6/10	10	20	1052260000
QL			
QL 2	2	50	0194300000
QL 3	3	50	0194400000
QL 4	4	50	0194500000
QL 10	10	20	0338300000
QL 15	15	10	0221200000
Connecting sleeves			
VH 12		100	0249000000
E-Cu 57 (copper alloy)			

WKB / WKS



WKB WKS 1 WKS 2

Type	No. of poles	Qty.	Order No.
WKB			
WKB 1/2	2	50	1604280000
WKB 1/3	3	50	1604300000
WKB 1/4	4	50	1604320000
WKB 1/10	10	20	1604330000
WKS			
WKS 1/2	2	50	1604270000
WKS 1/3	3	50	1604290000
WKS 1/4	4	50	1604310000
WKS 2/2	2	50	1936140000
WKS 2/3	3	50	1936150000

QS 2



Type	No. of poles	Qty.	Order No.
QS			
QS 2	2	20	0270960000
x = 8 mm, y = 16 mm			
QS 2	2	20	0270860000
x = 10 mm, y = 20 mm			
QS 2	2	20	0270760000
x = 12 mm, y = 20 mm			

B



Testing made easy

WTL 6 SL / WTD 6 SL

Current transformers may only be short-circuited or operated with a negligible load impedance because open current transformers “run hot” and destroy themselves. Apart from that, load impedances lead to measuring inaccuracies in electricity supply meters and hence to financial losses for their operators.

Many switching tasks can be done using the WTL 6 SL test/disconnect terminals and the WTD 6 SL feed-through terminals.

The screws for connecting the conductors are only accessible after the current transformer has been short-circuited with the help of the short-circuit slider. This guarantees that the measuring instrument is not accidentally disconnected.

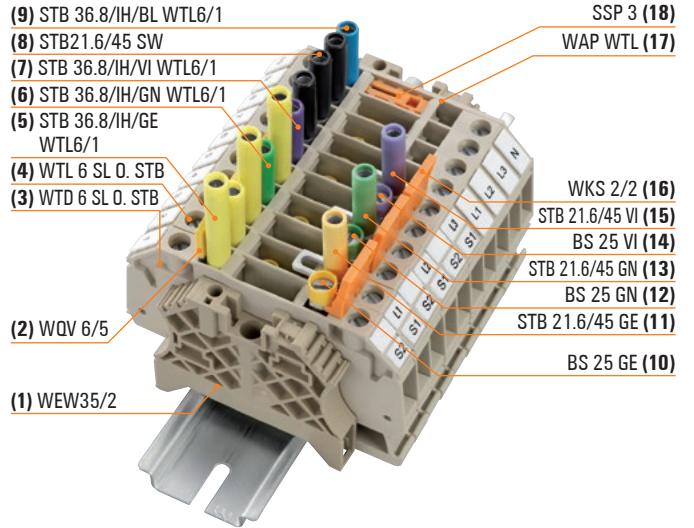

Example transformer using WTL 6 SL / WTD 6 SL

Ordering data

Pos.	Type	Order No.	Qty.
1	WEW35/2	1061200000	2
2	WQV 6/5	1062660000	1
3	WTD 6 SL O. STB	1238920000	3
4	WTL 6 SL O. STB	1238930000	7
5	STB 36.8/IH/GE WTL6/1	1847760000	4
6	STB 36.8/IH/GN WTL6/1	1847770000	1
7	STB 36.8/IH/VI WTL6/1	1847780000	1
8	STB21.6/45 SW	1936270000	3
9	STB 36.8/IH/BL WTL6/1	1847790000	1
10	BS 25 GE	0335700000	1
11	STB 21.6/45 GE	1936240000	1
12	BS 25 GN	0335600000	1
13	STB 21.6/45 GN	1936250000	1
14	BS 25 VI	0335800000	1
15	STB 21.6/45 VI	1936260000	1
16	WKS 2/2	1936150000	3
17	WAP WTL	9538110000	1
18	SSP 3	0531760000	1
19	GWHUE M3 WTL6	1255010000	3
20	VH 19	0318000000	6

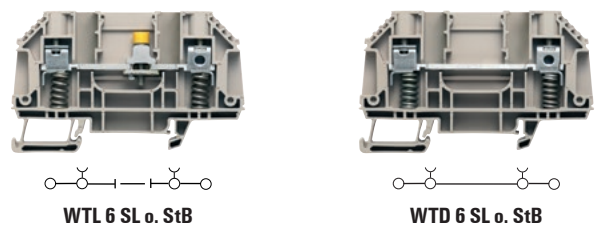
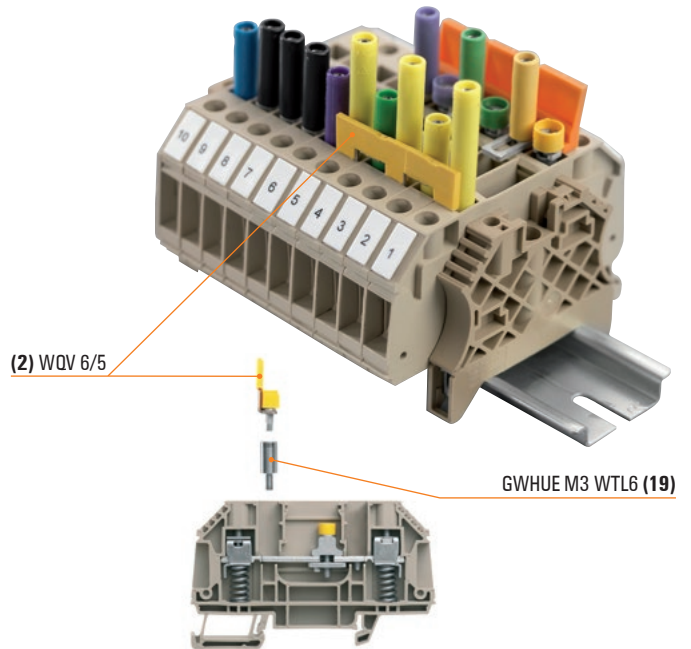



WTL 6 SL

6 mm²

WTD 6 SL

6 mm²

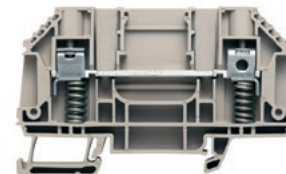
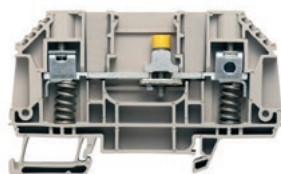

Feed-through

Width/Height/Depth	mm
max. current / max. cond. cross-section	A
Max. clamping range	mm ²

7.9 x 82.7 x 50
57 / 6
0.5...6

7.9 x 82.7 x 50
57 / 6
0.5...6

Technical data

Rated data	
Rated voltage	V
Rated current	A
for wire cross-section	mm ²
Rated impulse withstand voltage / Pollution severity	
Gauge to IEC 60947-1 / UL 94 flammability rating	
Approvals	
Clamped conductors (H05V/H07V)	
Solid / Stranded	mm ²
Flexible / Flexible with ferrule	mm ²
Tightening torque / Clamping screw	Nm
Tightening torque Separating screw	Nm
Stripping length / Blade size	mm/-

IEC 60947-7-1			
IEC	UL	CSA	EN 60079-7
630			
41			
6			
		6 kV / 2	
		A5 / V-0	
CE ENEC			
Rated connection			
0.5...6 6			
0.5...6			
0.8...1.6 / (M 3.5)			
0.5...0.7			
16 / 0.8 x 4.0 mm			

IEC 60947-7-1			
IEC	UL	CSA	EN 60079-7
630			
41			
6			
		6 kV / 2	
		A5 / V-0	
CE ENEC			
Rated connection			
0.5...6 6			
0.5...6			
0.8...1.6 / (M 3.5)			
16 / 0.8 x 4.0 mm			

Note

Ordering data

Version	
With socket	
without socket	
Note	

Type	Qty.	Order No.
WTL 6 SL	50	1161690000
WTL 6 SL 0.STB	50	1238930000

Type	Qty.	Order No.
WTD 6 SL	50	9538090000
WTD 6 SL 0.STB	50	1238920000

Accessories

Screwable cross-connection	
2-pole	
3-pole	
4-pole	
10-pole	
Threaded bushing	
Standard	
End plate / Partition plate	
Black	
dark beige	
dark beige	
End bracket	
dark beige	
Hak. Cable lugs	
Marking tags	

Type	Qty.	Order No.
WQV 6/2	57 A 50	1052360000
WQV 6/3	57 A 50	1054760000
WQV 6/4	57 A 50	1054860000
WQV 6/10	57 A 20	1052260000
GWHUE M3 WTL6	50	1255010000
WAP WTL6 SL	20	9538110000
WAP WTL6 SL 4-6	20	1238880000
WTW EN	20	1058800000
WEW 35/2	50	1061200000
HBT 1,5 - 4,6 RT	100	1233340000
HBT 2,5 - 4,6 BL	100	1233330000
HBT 6,0 - 4,6 GE	100	1216230000
WS 12/6.5 MC NE WS	540	1609920000

Type	Qty.	Order No.
WQV 6/2	57 A 50	1052360000
WQV 6/3	57 A 50	1054760000
WQV 6/4	57 A 50	1054860000
WQV 6/10	57 A 20	1052260000
GWHUE M3 WTL6	50	1255010000
WAP WTL6 SL	20	9538110000
WAP WTL6 SL 4-6	20	1238880000
WTW EN	20	1058800000
WEW 35/2	50	1061200000
HBT 1,5 - 4,6 RT	100	1233340000
HBT 2,5 - 4,6 BL	100	1233330000
HBT 6,0 - 4,6 GE	100	1216230000
WS 12/6.5 MC NE WS	540	1609920000

For detailed information on other accessories and application in the online catalogue



Testing made easy

WTL 6 SL EN / WTD 6 SL EN

Current transformers may only be short-circuited or operated with a negligible load impedance because open current transformers “run hot” and destroy themselves. Apart from that, load impedances lead to measuring inaccuracies in electricity supply meters and hence to financial losses for their operators.

Many switching tasks can be done using the WTL 6 SL EN test/disconnect terminals and the WTD 6 SL EN feed-through terminals.

The screws for connecting the conductors are only accessible after the current transformer has been short-circuited with the help of the short-circuit slider. This guarantees that the measuring instrument is not accidentally disconnected.

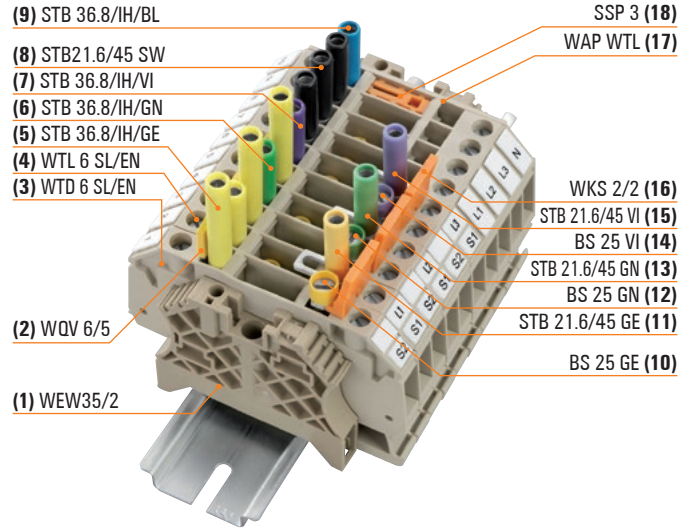

Example transformer using WTL 6 SL EN / WTD 6 SL EN

Ordering data

Pos.	Type	Order No.	Qty.
1	WEW35/2	1061200000	2
2	WQV 6/5	1062660000	1
3	WTD 6 SL EN	9538100000	3
4	WTL 6 SL EN	9538080000	7
5	STB 36.8/IH/GE	1847760000	4
6	STB 36.8/IH/GN	1847770000	1
7	STB 36.8/IH/VI	1847780000	1
8	STB21.6/45 SW	1936270000	3
9	STB 36.8/IH/BL	1847790000	1
10	BS 25 GE	0335700000	1
11	STB 21.6/45 GE	1936240000	1
12	BS 25 GN	0335600000	1
13	STB 21.6/45 GN	1936250000	1
14	BS 25 VI	0335800000	1
15	STB 21.6/45 VI	1936260000	1
16	WKS 2/2	1936150000	3
17	WAP WTL	9538110000	1
18	SSP 3	0531760000	1
19	GWHUE M3 WTL6	1255010000	3
20	VH 19	0318000000	6

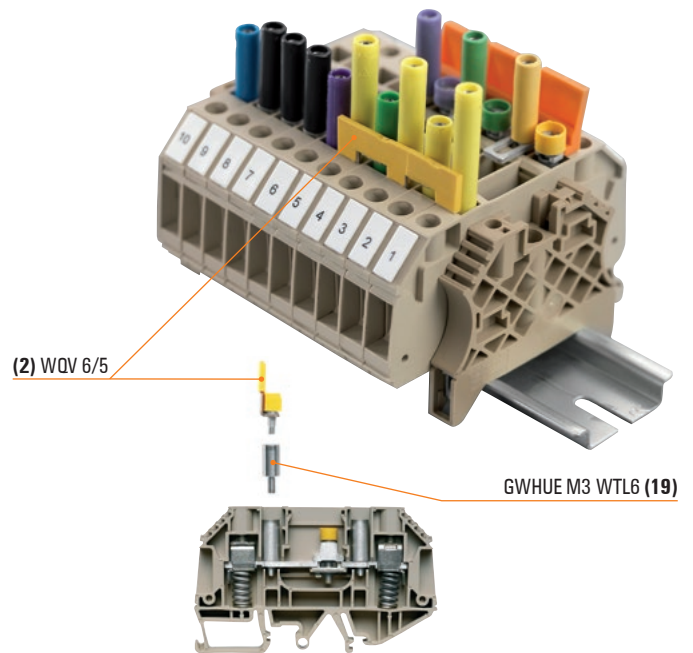



WTL 6 SL/EN

6 mm²

Longitudinal - disconnecter

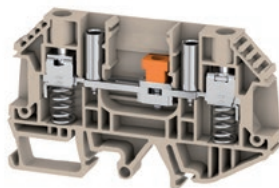

7.9 x 82.7 x 49.5

57 / 6

0.5...6



WTD 6 SL/EN

6 mm²

Feed-through

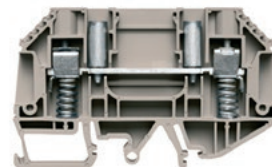

7.9 x 82.7 x 49.5

57 / 6

0.5...6

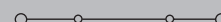

Width/Height/Depth	mm
max. current / max. cond. cross-section	A
Max. clamping range	mm ²

Technical data

Rated data	
Rated voltage	V
Rated current	A
for wire cross-section	mm ²
Rated impulse withstand voltage / Pollution severity	
Gauge to IEC 60947-1 / UL 94 flammability rating	
Approvals	
Clamped conductors (H05V/H07V)	
Solid / Stranded	mm ²
Flexible / Flexible with ferrule	mm ²
Tightening torque / Clamping screw	Nm
Tightening torque Separating screw	Nm
Stripping length / Blade size	mm/-

Note

Ordering data

Version	
	With socket
Note	

Accessories

Screwable cross-connection	
	2-pole
	3-pole
	4-pole
	10-pole
End plate / Partition plate	
	Black
	dark beige
	dark beige
End bracket	
	dark beige
Hak. Cable lugs	
Marking tags	
Threaded bushing	
	Standard

For detailed information on other accessories and application in the online catalogue

IEC 60947-7-1

IEC	UL	CSA	EN 60079-7
630			
41			
6			
	6 kV / 2		
	A5 / V-0		

CE

Rated connection	
0.5...6	6
0.5...6	
0.8...1.6 / (M 3.5)	
0.5...0.7	
16 / 0.8 x 4.0 mm	

IEC 60947-7-1

IEC	UL	CSA	EN 60079-7
630			
41			
6			
	6 kV / 2		
	A5 / V-0		

CE

Rated connection	
0.5...6	6
0.5...6	
0.8...1.6 / (M 3.5)	
16 / 0.8 x 4.0 mm	

Type	Qty.	Order No.
WTL 6 SL/EN	50	9538080000

Type	Qty.	Order No.
WQV 6/2	57 A 50	1052360000
WQV 6/10	57 A 20	1052260000
WAP WTL6 SL	20	9538110000
WAP WTL6 SL 4-6	20	1238880000
WTW EN	20	1058800000
WEW 35/2	50	1061200000
HBT 1,5 - 4,6 RT	100	1233340000
HBT 2,5 - 4,6 BL	100	1233330000
HBT 6,0 - 4,6 GE	100	1216230000
WS 12/6.5 MC NE WS	540	1609920000
GWHUE M3 WTL6	50	1255010000

Type	Qty.	Order No.
WTD 6 SL/EN	50	9538100000

Type	Qty.	Order No.
WQV 6/2	57 A 50	1052360000
WQV 6/3	57 A 50	1054760000
WQV 6/4	57 A 50	1054860000
WQV 6/10	57 A 20	1052260000
WAP WTL6 SL	20	9538110000
WAP WTL6 SL 4-6	20	1238880000
WTW EN	20	1058800000
WEW 35/2	50	1061200000
HBT 1,5 - 4,6 RT	100	1233340000
HBT 2,5 - 4,6 BL	100	1233330000
HBT 6,0 - 4,6 GE	100	1216230000
WS 12/6.5 MC NE WS	540	1609920000



Instrument transformer wiring
Screw connection

Test-disconnect terminal blocks

WTL 6/3

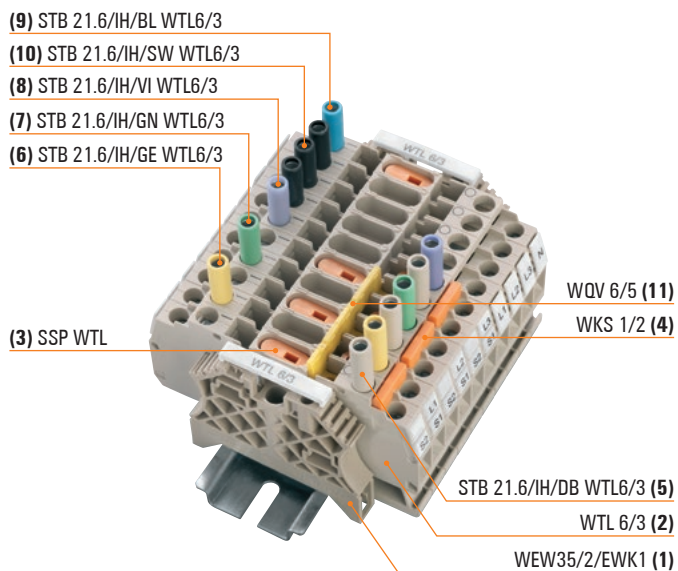

B

Ordering data

Pos.	Type	Order No.	Order No.	Qty.
1	WEW35/2/EWK1	1061200000	0206160000	2
2	WTL 6/3	1018800000		10
3	SSP WTL	1604200000	1604200000	4
4	WKS 1/2	1604270000	1604270000	3

Optionally available for better labelling for WTL 6/3 (instead of 14 x pos. 3):

Pos.	Type	Order No.	Order No.	Qty.
5	STB 21.6/IH/DB WTL6/3	1071000000	1071000000	7
6	STB 21.6/IH/GE WTL6/3	1071010000	1071010000	2
7	STB 21.6/IH/GN WTL6/3	1071020000	1071020000	2
8	STB 21.6/IH/VI WTL6/3	1071030000	1071030000	2
9	STB 21.6/IH/BL WTL6/3	1071080000	1071080000	1
10	STB 21.6/IH/SW WTL6/3	1071040000	1071040000	3

Additionally available for a shared k-point:

Pos.	Type	Order No.	Order No.	Qty.
11	WQV 6/5	1062660000	1062660000	1



WTL 6/3

6 mm²

Longitudinal - disconnect



Width/Height/Depth	mm
max. current / max. cond. cross-section	A
Max. clamping range	mm ²

7.9 x 87 x 64

57 / 10

0.5...10

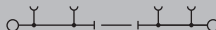

Technical data

Rated data	
Rated voltage	V
Rated current	A
for wire cross-section	mm ²
Rated impulse withstand voltage / Pollution severity	
Gauge to IEC 60947-1 / UL 94 flammability rating	
Approvals	

Clamped conductors (H05V/H07V)

Solid / Stranded	mm ²
Flexible / Flexible with ferrule	mm ²
Tightening torque (clamping screw for copper conductors)	-
Tightening torque (separating screw)	-
Stripping length / Blade size	mm/-

Note

Ordering data

Version	
With socket	
without socket	

Note

Accessories

Screwable cross-connection	
	2-pole
	3-pole
	4-pole
	10-pole

End bracket

dark beige

Cross-connection slider

2-pole
3-pole
4-pole

Testing / Checking

Test plug
Socket - blue
Socket - yellow
Socket - green
Socket - magenta

Miscellaneous accessories

Lockout device

Marking tags

IEC	UL	CSA	EN 60079-7
500	300	300	
41	45	45	
6	AWG 20...8	AWG 20...8	
6 kV / 3			
A5 / V-0			

CE

Rated connection

0.5...10 / 10...10

0.5...10 / 0.5...6

/(M 3.5)

12 / 0.8 x 4.0 mm

Type	Qty.	Order No.
WTL 6/3/STB	50	1018600000
WTL 6/3	50	1018800000

TS 32 version on request

Type	Qty.	Order No.
WQV 6/2	57 A 50	1052360000
WQV 6/3	57 A 50	1054760000
WQV 6/4	57 A 50	1054860000
WQV 6/10	57 A 20	1052260000

WEW 35/2 50 1061200000

WKS 1/2	41 A 50	1604270000
WKS 1/3	41 A 50	1604290000
WKS 1/4	41 A 50	1604310000

PS 4 F.STB 4	20	0299600000
STB 21.6/IH/BL WTL6/3	50	1071080000
STB 21.6/IH/GE WTL6/3	50	1071010000
STB 21.6/IH/GN WTL6/3	50	1071020000
STB 21.6/IH/VI WTL6/3	50	1071030000

SSP WTL6/2 100 1604200000

DEK 5/8 MC NE WS 800 1856740000

WS 12/8 PLUS MC NE WS 420 1906000000

For detailed information on other accessories and application in the online catalogue

For further modular disconnect test terminal accessories, refer to chapter on Accessories.

Instrument transformer wiring

Screw connection

Test-disconnect terminal blocks

WTL 35

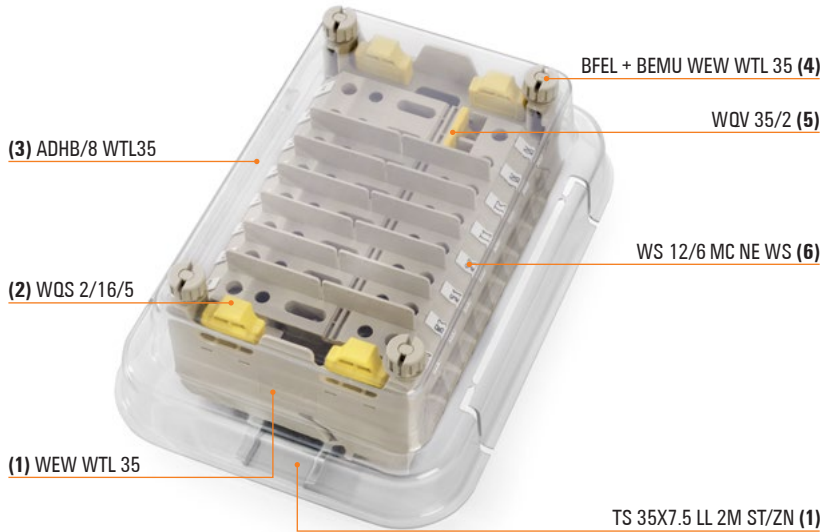

B

Ordering data

Pos.	Type	Order No.	Qty.
1	WEW WTL 35	1925040000	10
2	WQS 2/16/5	1925070000	10
3	ADHB/8 WTL35	2334730000	25
4	BFEL + BEMU WEW WTL 35	1964820000	20
5	WQV 35/2	1053060000	50
6	WS 12/6 MC NE WS	1609900000	600
7	TS 35X7.5 LL 2M ST/ZN	0514500000	2



WTL 35

35 mm²

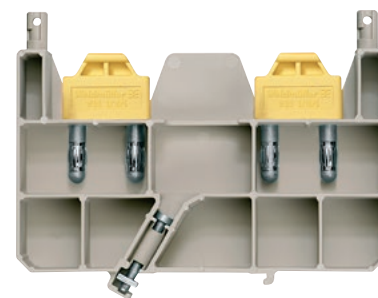

Width/Height/Depth	mm
max. current / max. cond. cross-section	A
Max. clamping range	mm ²

16 x 100 x 67.5
125 / 35
4...35

Technical data

Rated data	
Rated voltage	V
Rated current	A
for wire cross-section	mm ²
Rated impulse withstand voltage / Pollution severity	
Gauge to IEC 60947-1 / UL 94 flammability rating	
Approvals	
Clamped conductors (H05V/H07V)	
Solid / Stranded	mm ²
Flexible / Flexible with ferrule	mm ²
Tightening torque / Clamping screw	-
Tightening torque Separating screw	Nm
Stripping length / Blade size	mm/-

IEC	UL	CSA	EN 60079-7
500			
125			
35			
	6 kV / 3		
	B9 / V-0		
CE			
Rated connection			
4...16 / 10...35			
4...35 / 4...35			
/ (M 6)			
1.7...2.4			
18 / 6.5 x 1.2 mm			

Note

Ordering data

Version	
	with 2 sockets
	With socket
	with Socket

Note

Type	Qty.	Order No.
WTL 35/1STB/WQV	10	1925050000
WTL 35/2STB	10	1925030000
WTL 35/1STB	10	1925060000

Accessories

Screwable cross-connection	2-pole
End bracket	
Cover	dark beige
Fastenings	
Screwdriver	Standard
Marking tags	

Type	Qty.	Order No.	
WQV 35/2	138 A	50	1053060000
WQS 2/16/5	44 A	10	1925070000
WEW WTL 35	10	1925040000	
ADHB/8 WTL35	25	2334730000	
BFEL + BEMU WEW WTL 35	20	1964820000	
SDS 1.2X6.5X150	1	2749390000	
WS 12/6 MC NE WS	600	1609900000	

For detailed information on other accessories and application in the online catalogue



Instrument transformer wiring

Threaded stud connection

Test-disconnect terminal blocks

SDL 4

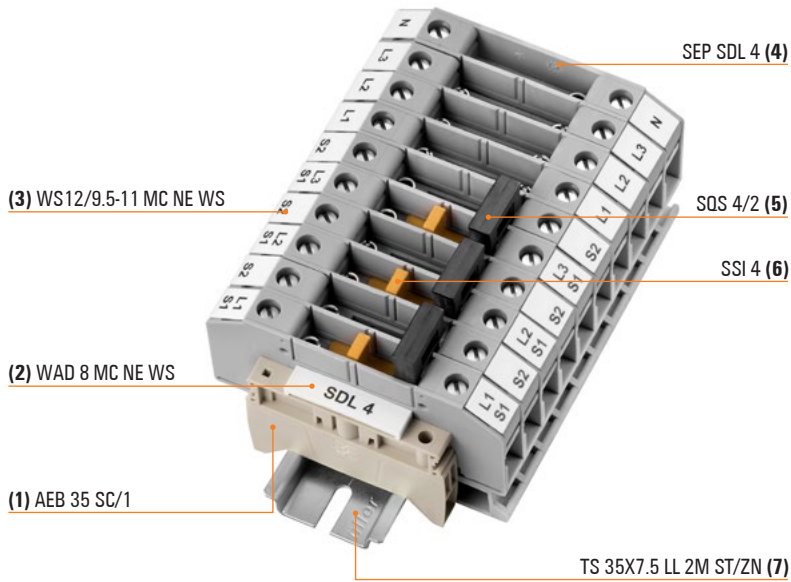

Ordering data

Pos.	Type	Order No.	Qty.
1	AEB 35 SC/1	1991920000	50
2	WAD 8 MC NE WS	1112940000	48
3	WS 12/9.5-11 MC NE WS	2484220000	300
4	SEP SDL 4	2615020000	50
5	SQS 4/2	2615250000	20
	SQS 4/4	2615260000	10
6	SSI 4	2615270000	50
7	TS 35X7.5 LL 2M ST/ZN	0514500000	2



SDL 4

6 mm²

SDL 4 FT

6 mm²

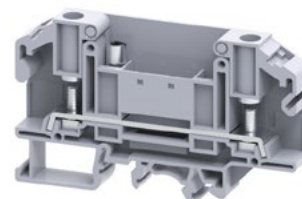
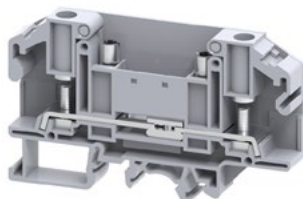

Width/Height/Depth	mm
Rated current / max. cond. cross-section	A
Max. clamping range	mm ²

11 x 86 x 51.5	
41 / 6 mm²	
1.5...6	

11 x 86 x 51.5	
41 / 6 mm²	
1.5...6	

Technical data

Rated data with Wemid partition wall	
Rated voltage	V
Rated current	A
for wire cross-section	mm ²
Rated impulse withstand voltage / Pollution severity	
Gauge to IEC 60947-1 / UL 94 flammability rating	
Approvals	
Clamped cable lugs	
Cable lug to DIN 46234	
2 x cable lugs DIN 46 234	
Cable lug to DIN 46235	
2 x cable lugs DIN 46 235	
Tightening torque	

IEC 60947-7-1			
IEC	UL	CSA	EN 60079-7
1000	600		
41	35		
6			
8 kV / 3			
1.5...6 mm ²			
1.5...6 mm ²			
1.5...6 mm ²			
1.5...6 mm ²			
1.2...1.2 Nm			

IEC 60947-7-1			
IEC	UL	CSA	EN 60079-7
1000	600		
41	50		
6	AWG 22...8		
8 kV / 3			
1.5...6 mm ²			
1.5...6 mm ²			
1.5...6 mm ²			
1.5...6 mm ²			
1.2...1.2 Nm			

Note

Ordering data

Version	dark beige
Note	

Type	Qty.	Order No.
SDL 4	50	2614980000

Type	Qty.	Order No.
SDL 4 FT	50	2614970000

Accessories

Plug-in cross-connection	
2-pole	
3-pole	
4-pole	
2-pole	
4-pole	
Cross-connection permanent	
2-pole	
3-pole	
4-pole	
End plate	
dark beige	
End bracket	
dark beige, screwable	
Screwdriver	
Standard	
Marking tags	

Type	Qty.	Order No.
SRQB 4/2	41 A 100	2615220000
SRQB 4/3	41 A 50	2615230000
SRQB 4/4	41 A 50	2615240000
SQS 4/2	41 A 20	2615250000
SQS 4/4	41 A 10	2615260000
Cross-connection permanent		
SQB 4/2	41 A 100	2615140000
SQB 4/3	41 A 50	2615150000
SQB 4/4	41 A 50	2615160000
SEP SDL 4	50	2615020000
AEB 35 SC/1	50	1991920000
SDS 1.0X5.5X150	1	2749380000
WS 12/9.5-11 MC NE WS	300	2484220000

Type	Qty.	Order No.
SRQB 4/2	41 A 100	2615220000
SRQB 4/3	41 A 50	2615230000
SRQB 4/4	41 A 50	2615240000
SQS 4/2	41 A 20	2615250000
SQS 4/4	41 A 10	2615260000
Cross-connection permanent		
SQB 4/2	41 A 100	2615140000
SQB 4/3	41 A 50	2615150000
SQB 4/4	41 A 50	2615160000
SEP SDL 4	50	2615020000
AEB 35 SC/1	50	1991920000
SDS 1.0X5.5X150	1	2749380000
WS 12/9.5-11 MC NE WS	300	2484220000

For detailed information on other accessories and application in the online catalogue



Clear wiring for high-density signalling levels

With Klippon® Connect in the smallest spaces



With the current levels of automation, there are more and more sensors monitoring the production process. This increases the number of signals to be combined and structured. Given the restricted space in the panel, this can become a real challenge. Our application-specific initiator/actuator terminal blocks (AIO) are specially designed for the signal wiring requirements posed by automation now and into the future. You can benefit from tailored, really compact solutions for the structured wiring of initiator and actuator signals with the input and output modules of a programmable logic controller (PLC).

Our promise

With tailored application products, Klippon® Connect offers all the benefits required for structured wiring of initiator and actuator signals. The simple handling and the maximum flexibility in the choice of design meets the requirements for reliable signal wiring simply, efficiently and safely.

B

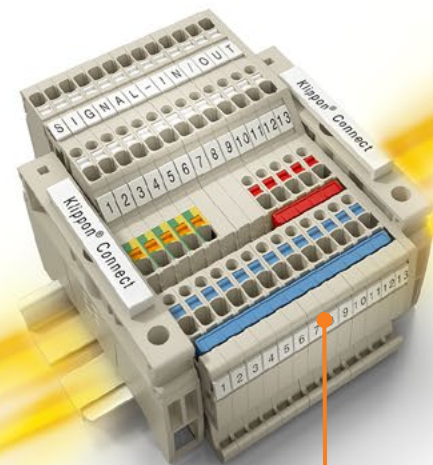

Safety

- Test options on every terminal
- Vibration-resistant and gas-tight connections
- Top-level safety for machines and systems

Space saving

- Up to four different potentials on a terminal just 3.5 mm wide
- Structuring and combining of signals in confined spaces

Time saving

- Simple to use thanks to PUSH IN technology
- Convenient plus/minus potential distribution through range of cross connection options
- Simple wiring thanks to colour-coded pushers

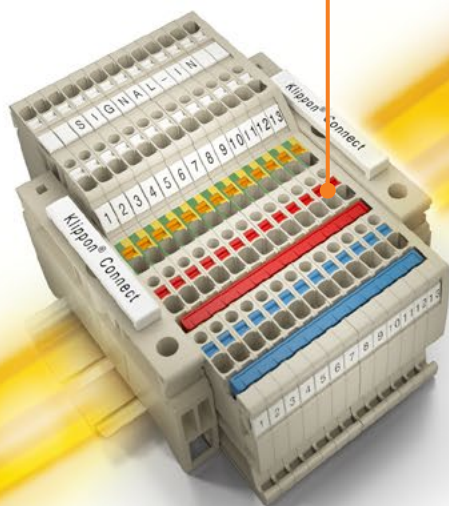
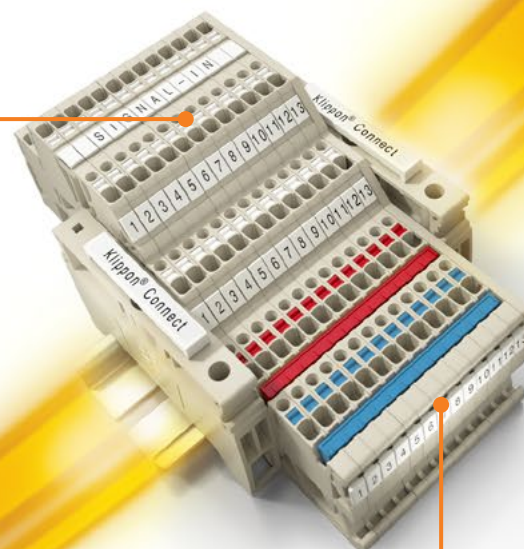
**Flexibility**

- Maximum clarity thanks to wide variety of labelling options
- User and service-friendly thanks to clear design
- A wide assortment of variants in three designs

B

Our range**Extreme flexibility in potential distribution:**

With our application products, you can achieve effective and safe potential distribution while looping the signals to the I/O system. You can benefit from increased wiring density with more potentials on a single terminal block. This not only saves space, but also reduces the time required to assemble the terminal block.

**Free choice of design:**

Our application products for signal wiring (AIO) are available in three designs. Depending on the design, you can connect 3- or 4-wire sensors or actuators. The large number of variants, e.g. with built-in PE function, allows maximum flexibility when it comes to designing the signal feed.



Signal wiring
PUSH IN connection

Application range

AIO – sensor-actuator terminal blocks



Width/Height/Depth	mm
max. current / max. cond. cross-section	A/mm ²
Max. clamping range	mm ²

Technical data

Rated data	
Rated voltage	V
Rated current	A
for wire cross-section	mm ²
Rated impulse withstand voltage / Pollution severity	
Gauge to IEC 60947-1 / UL 94 flammability rating	
Approvals	
Clamped conductors (H05V/H07V)	
Solid / Stranded	mm ²
Flexible / Flexible with ferrule	mm ²
Stripping length / Blade size	mm/-
Note	

Ordering data

Version	
	dark beige
	Orange
Note	

Accessories

Plug-in cross-connection	
	2-pole/ red
	10-pole / red
	2-pole / blue
	10-pole/ blue
End plate	
End bracket	
	dark beige, screwable
	dark beige, direct mounting
Test adapter	
	1-pole
	stackable
Test plug	
Screwdriver	
	Standard
Marking tags	

B



AI021 1.5 SI

1.5 mm²

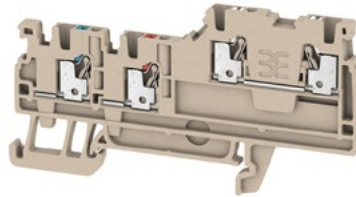

3.5 x 80 x 42	
13.5 / 1.5	
0.14...1.5	

Ex eb II C GbII
In accordance with IEC 60947-1 2 G D

IEC	UL	CSA	EN 60079-7
250	150	150	220
13.5	13	13	12
1.5	AWG 26...14	AWG 26...14	1.5 mm ²
4 kV / 3			
A1 / V-0			

Rated connection		
0.5...1.5 / 0.5...1.5		
0.5...1.5 / 0.5...1		
8 / 0.4 x 2.0 mm		

Type	Qty.	Order No.
AI021 1.5 SI	100	1992260000
AI021 1.5 SI OR	100	2579610000

Type	Qty.	Order No.
ZQV 1.5N/2 RD	17.5 A 60	1985650000
ZQV 1.5N/10 RD	17.5 A 20	1985800000
ZQV 1.5N/2 BL	17.5 A 60	1985530000
ZQV 1.5N/10 BL	17.5 A 20	1985680000
AEP IO21	50	1993580000
AEB 35 SC/1	50	1991920000
AEB 35 SCL/1 VO	20	2661280000
ATPG 1.5-10 L	0.2 A 50	1991890000
ATPG 1.5 MHR	0.2 A 50	1991880000
PS 2.0 MC	20	0310000000
SDS 0.4X2.0X60	1	2749260000
DEK 5/3.5 MM WS	1000	2007100000
WS 8/3.5 MM WS	1000	2007140000
DEK 5/3.5 PLUS MC NE WS	1600	2003750000

AI021 1.5 SO

1.5 mm²

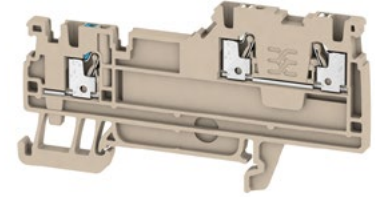

3.5 x 80 x 42	
13.5 / 1.5	
0.14...1.5	

Ex eb II C GbII
In accordance with IEC 60947-1 2 G D

IEC	UL	CSA	EN 60079-7
250	150	150	220
13.5	13	13	12
1.5	AWG 26...14	AWG 26...14	1.5 mm ²
4 kV / 3			
A1 / V-0			

Rated connection		
0.5...1.5 / 0.5...1.5		
0.5...1.5 / 0.5...1		
8 / 0.4 x 2.0 mm		

Type	Qty.	Order No.
AI021 1.5 SO	100	1992240000
AI021 1.5 SO OR	100	2579570000

Type	Qty.	Order No.
ZQV 1.5N/2 BL	17.5 A 60	1985530000
ZQV 1.5N/10 BL	17.5 A 20	1985680000
AEP IO21	50	1993580000
AEB 35 SC/1	50	1991920000
AEB 35 SCL/1 VO	20	2661280000
ATPG 1.5-10 L	0.2 A 50	1991890000
ATPG 1.5 MHR	0.2 A 50	1991880000
PS 2.0 MC	20	0310000000
SDS 0.4X2.0X60	1	2749260000
DEK 5/3.5 MM WS	1000	2007100000
WS 8/3.5 MM WS	1000	2007140000
DEK 5/3.5 PLUS MC NE WS	1600	2003750000

For detailed information on other accessories and application in the online catalogue

AI021 1.5 SO-PE

1.5 mm²

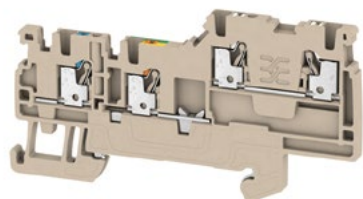

3.5 x 80 x 42
13.5 / 1.5
0.14...1.5

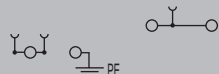

Ex eb II C Gbll

2 G D



In accordance with IEC 60947-7-1

IEC	UL	CSA	EN 60079-7
250	150	150	220
13.5	13	13	12
1.5	AWG 26...14	AWG 26...14	1.5 mm ²

AI022 1.5 SI-PE

1.5 mm²

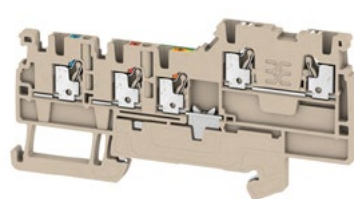

3.5 x 89 x 45
13.5 / 1.5
0.14...1.5

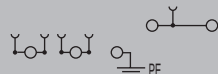

Ex eb II C Gbll

2 G D



In accordance with IEC 60947-7-1

IEC	UL	CSA	EN 60079-7
250	150	150	220
13.5	13	13	12
1.5	AWG 26...14	AWG 26...14	1.5 mm ²

AI023 1.5 2SI

1.5 mm²

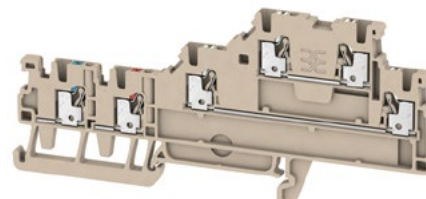

3.5 x 110 x 49.5
13.5 / 1.5
0.14...1.5

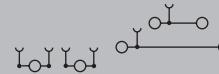

Ex eb II C Gbll

2 G D



In accordance with IEC 60947-7-1

IEC	UL	CSA	EN 60079-7
250	150	150	220
13.5	13	13	12
1.5	AWG 26...14	AWG 26...14	1.5 mm ²

4 kV / 3
A1 / V-0



Rated connection

0.5...1.5 / 0.5...1.5

0.5...1.5 / 0.5...1

8 / 0.4 x 2.0 mm

4 kV / 3
A1 / V-0



Rated connection

0.5...1.5 / 0.5...1.5

0.5...1.5 / 0.5...1

8 / 0.4 x 2.0 mm

4 kV / 3
A1 / V-0



Rated connection

0.5...1.5 / 0.5...1.5

0.5...1.5 / 0.5...1

8 / 0.4 x 2.0 mm

Type	Qty.	Order No.
AI021 1.5 SO-PE	100	1992250000
AI021 1.5 SO-PE OR	100	2579580000

Type	Qty.	Order No.
AI022 1.5 SI-PE	100	1992230000
AI022 1.5 SI-PE OR	100	2579640000

Type	Qty.	Order No.
AI023 1.5 2SI	100	1992220000
AI023 1.5 2SI OR	100	2579620000

Type	Qty.	Order No.
ZQV 1.5N/2 BL	17.5 A 60	1985530000
ZQV 1.5N/10 BL	17.5 A 20	1985680000
AEP IO21	50	1993580000
AEB 35 SC/1	50	1991920000
AEB 35 SCL/1 VO	20	2661280000
ATPG 1.5-10 L	0.2 A 50	1991890000
ATPG 1.5 MI-R	0.2 A 50	1991880000
PS 2.0 MC	20	0310000000
SDS 0.4X2.0X60	1	2749260000
DEK 5/3.5 MM WS	1000	2007100000
WS 8/3.5 MM WS	1000	2007140000
DEK 5/3.5 PLUS MC NE WS	1600	2003750000

Type	Qty.	Order No.
ZQV 1.5N/2 RD	17.5 A 60	1985650000
ZQV 1.5N/10 RD	17.5 A 20	1985800000
ZQV 1.5N/2 BL	17.5 A 60	1985530000
ZQV 1.5N/10 BL	17.5 A 20	1985680000
AEP IO22	50	1993590000
AEB 35 SC/1	50	1991920000
AEB 35 SCL/1 VO	20	2661280000
ATPG 1.5-10 L	0.2 A 50	1991890000
ATPG 1.5 MI-R	0.2 A 50	1991880000
PS 2.0 MC	20	0310000000
SDS 0.4X2.0X60	1	2749260000
DEK 5/3.5 MM WS	1000	2007100000
WS 8/3.5 MM WS	1000	2007140000
DEK 5/3.5 PLUS MC NE WS	1600	2003750000

Type	Qty.	Order No.
ZQV 1.5N/2 RD	17.5 A 60	1985650000
ZQV 1.5N/10 RD	17.5 A 20	1985800000
ZQV 1.5N/2 BL	17.5 A 60	1985530000
ZQV 1.5N/10 BL	17.5 A 20	1985680000
AEP IO23	50	1993600000
AEB 35 SC/1	50	1991920000
AEB 35 SCL/1 VO	20	2661280000
ATPG 1.5-10 L	0.2 A 50	1991890000
ATPG 1.5 MI-R	0.2 A 50	1991880000
PS 2.0 MC	20	0310000000
SDS 0.4X2.0X60	1	2749260000
DEK 5/3.5 MM WS	1000	2007100000
WS 8/3.5 MM WS	1000	2007140000
DEK 5/3.5 PLUS MC NE WS	1600	2003750000



A modular distribution system with proven tension-clamp connections

Distribution terminal bars from stackable single modules, consisting of carrier and base elements

The basis for this modular system is the side-by-side mounting of the individual modules of the distribution terminals with their integral cross-connection. The female contact is on one side, the male contact on the other. Thanks to the modular thin-element design, variable distribution strips can be set up to suit the application. The base elements, which are clipped onto TS 35 terminal rails, form the supports for these module combinations. These base elements are available in a number of different versions:

- Carrier elements with and without signal lines for 3- and 4-wire connections
- Modular construction which enables individual configuration

B

PLC
I/O

Simple operation

The distribution terminals with integrated cross-connections can be joined together and be snapped into the base elements by hand.

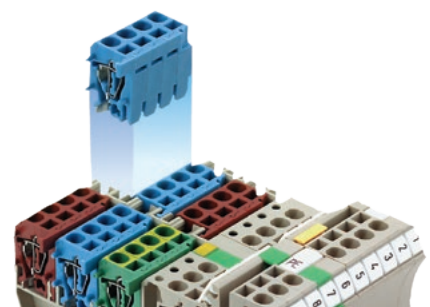

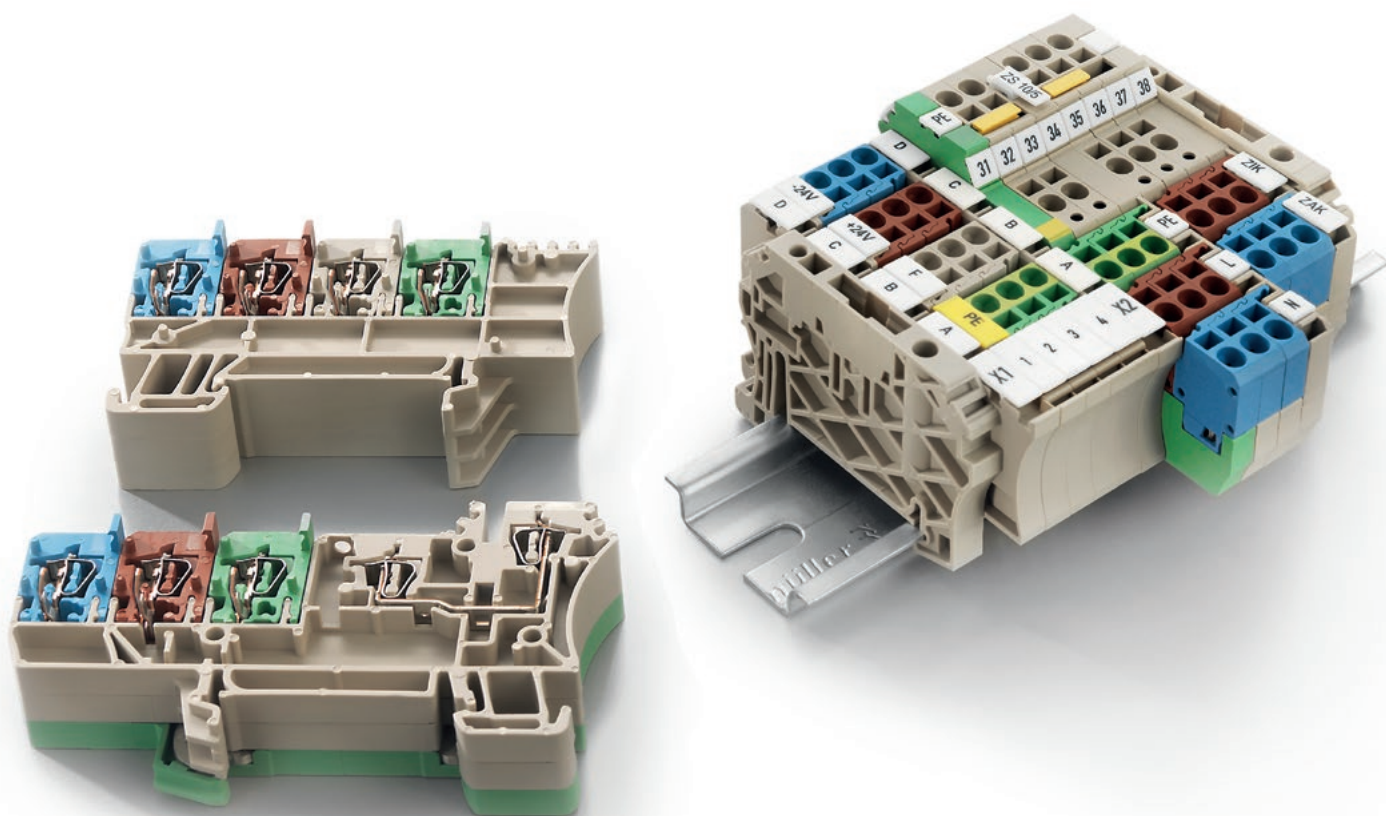

B

For initiators and actuators

The modular distribution strip system is a convenient way to supply initiators and actuators with three- or four-wire power connections.

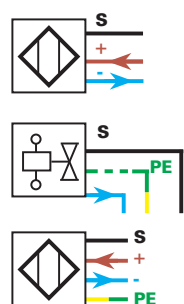

Modular system

Variable number of poles available on account of their simple connection or separation capabilities.

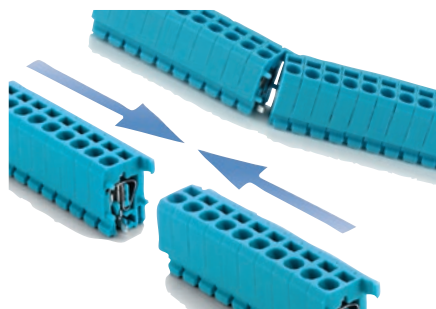

Integrated cross-connection

Potential distribution with integrated cross-connections of the male and female contacts.

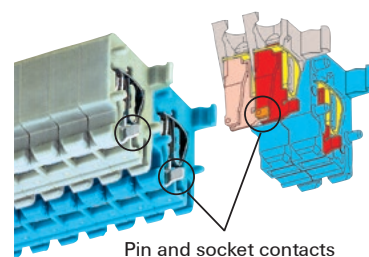

Signal wiring
Tension clamp connection



Width/Height/Depth	mm
max. current / max. cond. cross-section	-/-
Max. clamping range	-

Technical data

Rated data	
Rated voltage	V
Max. voltage of clamp support & pluggable system	-
Rated current	A
for wire cross-section	mm ²
Rated impulse withstand voltage / Pollution severity	
Gauge to IEC 60947-1 / UL 94 flammability rating	
Approvals	
Clamped conductors (H05V/H07V)	
Solid / Stranded	-
Flexible / Flexible with ferrule	-
Stripping length / Blade size	mm/-

Note

Ordering data

Version	
	Base terminal
	Base terminal with LED
	PE base terminal

Note

Accessories

Plug-in cross-connection	
	2-pole
	3-pole
	4-pole
	10-pole
	50-pole
Reducing sleeves	
	for conductors < 0.5 mm ² / AWG 20
	for conductors < 1.0 mm ² / AWG 18
End plate / Partition plate	
	dark beige
	With spigot
	Without peg
Screwdriver	
	Standard
Marking tags	

For detailed information on other accessories and application in the online catalogue

ZPV 1.5

1.5 mm²

Flange-mounted housing

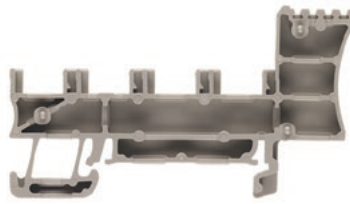

5.1 x 67.8 x 38.35

IEC 60947-7-1

IEC	UL	CSA	EN 60079-7
250	300		
17.5	10		
1.5	AWG 26...14	AWG 26...14	
4 kV / 3			
/ V-0			

CE

Rated connection

7 /

Type	Qty.	Order No.
ZPV 1.5	100	1676630000

Type	Qty.	Order No.
ZAP/TW ZPV1.5	50	1674650000
SDIS SLIM 0.6X3.5X100	1	2749610000
DEK 5/5 MC NE WS	1000	1609801044
WS 12/5 MC NE WS	720	1609860000

ZIA 1.5/3 L...

1.5 mm²

Base element 4-wire

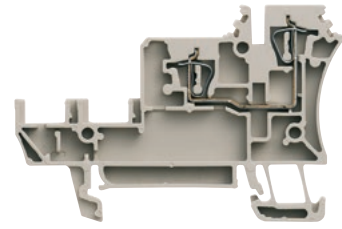

5.08 x 68.5 x 45.5

/ 2.5

0.13...2.5



In accordance with IEC 60947-7-1

IEC	UL	CSA	EN 60079-7
250	300	300	
17.5	10	10	
1.5	AWG 26...14	AWG 26...14	
4 kV / 3			
A1 / V-0			

CE

Rated connection

0.5...2.5
0.5...2.5 / 0.5...1.5
7 / 0.6 x 3.5 mm

Bi-directional LED in ZIA 1.5/3L-1/LD (1651990000)

Type	Qty.	Order No.
ZIA 1.5/3L-1S	100	1651980000
ZIA 1.5/3L-1S/LD-RT	50	1651990000
ZIA 1.5/3L-PE	20	1652000000

Type	Qty.	Order No.
ZQV 2.5/2	24 A 60	1608860000
ZQV 2.5/3	24 A 60	1608870000
ZQV 2.5/4	24 A 60	1608880000
ZQV 2.5/10	24 A 20	1608940000
ZQV 2.5/50	24 A 10	1697540000
ZRH 1.5N/1	1000	1632140000
ZRH 1.5N/2	1000	1632130000
ZAP/TW ZIA1.5/3L	50	1649540000
SDIS SLIM 0.6X3.5X100	1	2749610000
DEK 5/5 MC NE WS	1000	1609801044



ZIA 1.5/4 L...

1.5 mm²

Base element 4-wire

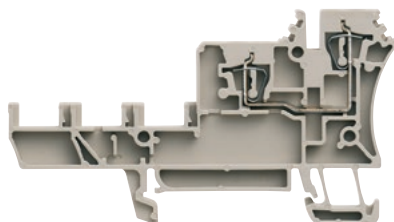

Width/Height/Depth	mm
max. current / max. cond. cross-section	-/mm ²
Max. clamping range	mm ²

5.08 x 81.5 x 45.5	
/ 2.5	
0.13...2.5	

Technical data

Rated data	
Rated voltage	V
Max. voltage of clamp support & pluggable system	-
Rated current	A
for wire cross-section	mm ²
Rated impulse withstand voltage / Pollution severity	
Gauge to IEC 60947-1 / UL 94 flammability rating	
Approvals	
Clamped conductors (H05V/H07V)	
Solid / Stranded	mm ²
Flexible / Flexible with ferrule	mm ²
Stripping length / Blade size	mm/-

Note

Ordering data

Version	
	dark beige
	dark beige
	Blue
	Green/yellow
	Base terminal
	Base terminal with LED
	PE base terminal
	Brown

Note

Accessories

Plug-in cross-connection	
	2-pole
	3-pole
	4-pole
	10-pole
	50-pole
Reducing sleeves	
	for conductors < 1.0 mm ² / AWG 18
	for conductors < 0.5 mm ² / AWG 20
End plate / Partition plate	
	dark beige
	Without peg
	With spigot
Screwdriver	
	Standard
Marking tags	

For detailed information on other accessories and application in the online catalogue

ZVL 1.5

1.5 mm²

Distribution strip



5.08 x 12.9 x 17.45	
/ 2.5	
0.13...2.5	

IEC 60947-1			
IEC	UL	CSA	EN 60079-7
250	300	300	
17.5	10	10	
1.5	AWG 26...14	AWG 26...14	
		4 kV / 3	
		A2 / V-0	

Rated connection	
0.5...2.5	
0.5...2.5 / 0.5...2.5	
7 / 0.6 x 3.5 mm	

Note

Ordering data

Type	Qty.	Order No.
ZVL 1.5	100	1649300000
ZVL 1.5 0.QV	100	1711930000
ZVL 1.5 BL	100	1650360000
ZVL 1.5/PE GN/GE BED	100	1651970000
ZVL 1.5 BR	100	1650370000

Note

Ordering data

Type	Qty.	Order No.
ZRH 1.5N/2	1000	1632130000
ZRH 1.5N/1	1000	1632140000
ZAP/TW ZIA1.5/4L	50	1649550000
BZT ZVL1.5/0.ZA	100	1676620000
BZT ZVL1.5	100	1676610000
SDIS SLIM 0.6X3.5X100	1	2749610000
DEK 5/5 MC NE WS	1000	1609801044

For detailed information on other accessories and application in the online catalogue



Signal wiring
Screw connection



Width/Height/Depth	mm
max. current / max. cond. cross-section	A/mm ²
Max. clamping range	mm ²

Technical data

Rated data	
Rated voltage	V
Rated current	A
for wire cross-section	mm ²
Rated impulse withstand voltage / Pollution severity	
Gauge to IEC 60947-1 / UL 94 flammability rating	
Approvals	
Electronic fixtures	
Component voltage / Component current	-/-
Operating voltage for display, max. / Current	-/-
Clamped conductors (H05V/H07V)	
Solid / Stranded	mm ²
Flexible / Flexible with ferrule	mm ²
Tightening torque / Clamping screw	Nm
Stripping length / Blade size	mm/-
Note	

Ordering data

Version	
	dark beige
	dark beige (red LED)
	dark beige (green LED)
Note	

Accessories

Screwable cross-connection	
	2-pole
	3-pole
	4-pole
	10-pole
Cross-connector	
	black
	red
	blue
End plate / Partition plate	
	dark beige
End bracket	
	dark beige
Screwdriver	
	Standard
Small partition	
	Small partition
Marking tags	

For detailed information on other accessories and application in the online catalogue

DLD 2.5

2.5 mm²

Voltage supply

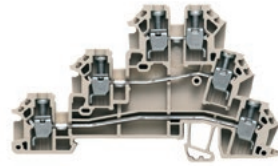

6.2 x 82.5 x 48.5
24 / 4
0.13...4

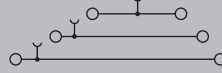

IEC 60947-7-1

IEC	UL	CSA	EN 60079-7
250	300	300	
24	10	10	
2.5	AWG 26...12	AWG 26...12	
4 kV / 3			
A3 / V-0			



Rated connection

0.5...4 / 0.5...4
0.5...4
0.4...0.6 / (M 2.5)
7 / 0.6 x 3.5 mm

Rated voltage is reduced to 30 V AC when one pole with a different potential is skipped with a cross-connector.

Type	Qty.	Order No.
DLD 2.5 DB	50	1784180000

Type	Qty.	Order No.
Q 2 DLI	24 A 50	1312500000
Q 3 DLI	24 A 50	1312600000
Q 4 DLI	24 A 50	1312700000
Q 10 DLI	24 A 20	1313100000

VQB 1.5/50 SW	17.5 A 5	1635120000
VQB 1.5/50 RT	17.5 A 5	1633290000
VQB 1.5/50 BL	17.5 A 5	1633280000

AP DLI2.5 DB	20	1783550000
--------------	----	------------

EW 35	50	0383560000
-------	----	------------

SDS 0.6X3.5X100	1	2749340000
-----------------	---	------------

TSCH 1	100	0319160000
--------	-----	------------

DEK 5/6 MC NE WS	1000	1609820000
------------------	------	------------

TEAP DLD2.5 DB partial end plate, Order no. 1784220000 (20 pcs.)

DLD 2.5 PE

2.5 mm²

Lower level earthed

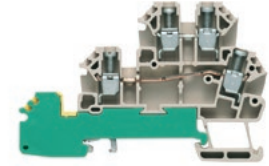

6.1 x 74.5 x 48.5
17.5 / 4
0.13...4

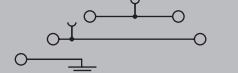

IEC 60947-7-1

IEC	UL	CSA	EN 60079-7
250	300		
17.5	10	10	
2.5	AWG 26...12	AWG 26...12	
4 kV / 3			
A3 / V-0			



Rated connection

0.5...4 / 0.5...4
0.5...4
0.4...0.6 / (M 2.5)
7 / 0.6 x 3.5 mm

Rated voltage is reduced to 30 V AC when one pole with a different potential is skipped with a cross-connector.

Type	Qty.	Order No.
DLD 2.5/PE DB	50	1783790000

Type	Qty.	Order No.
Q 2 DLI	24 A 50	1312500000
Q 3 DLI	24 A 50	1312600000
Q 4 DLI	24 A 50	1312700000
Q 10 DLI	24 A 20	1313100000

VQB 1.5/50 SW	17.5 A 5	1635120000
VQB 1.5/50 RT	17.5 A 5	1633290000
VQB 1.5/50 BL	17.5 A 5	1633280000

AP DLD2.5/PE DB	20	1783800000
-----------------	----	------------

EW 35	50	0383560000
-------	----	------------

SDS 0.6X3.5X100	1	2749340000
-----------------	---	------------

TSCH 1	100	0319160000
--------	-----	------------

DEK 5/6 MC NE WS	1000	1609820000
------------------	------	------------

TEAP DLD2.5/PE DB partial end plate, Order no. 1783810000 (20 pcs.)

DLI 2.5

2.5 mm²

Initiator connection (signal,+,-)

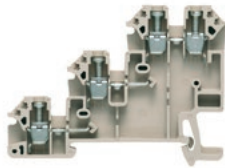

6.1 x 66 x 48.5
32 / 4
0.13...4

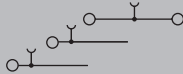

IEC 60947-7-1

IEC	UL	CSA	EN 60079-7
250	300	300	
24	10	10	
2.5	AWG 26...12	AWG 26...12	
4 kV / 3			
A3 / V-0			



Rated connection

0.5...4 / 1.5...4
0.5...4
0.4...0.6 / (M 2.5)
7 / 0.6 x 3.5 mm

Rated voltage is reduced to 30 V AC when one pole with a different potential is skipped with a cross-connector.

Type	Qty.	Order No.
DLI 2.5 DB	100	1783820000

Type	Qty.	Order No.
Q 2 DLI	24 A 50	1312500000
Q 3 DLI	24 A 50	1312600000
Q 4 DLI	24 A 50	1312700000
Q 10 DLI	24 A 20	1313100000
VQB 1.5/50 SW	17.5 A 5	1635120000
VQB 1.5/50 RT	17.5 A 5	1633290000
VQB 1.5/50 BL	17.5 A 5	1633280000
AP DLI 2.5 DB	20	1783550000
EW 35	50	0383560000
SDS 0.6X3.5X100	1	2749340000
TSCH 1	100	0319160000
DEK 5/6 MC NE WS	1000	1609820000

DLI 2.5 LD PNP

2.5 mm²

Initiator connection with LED

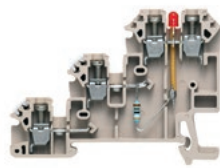

6.1 x 66 x 48.5
24 / 4
0.13...4

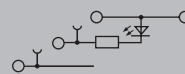

IEC 60947-7-1

IEC	UL	CSA	EN 60079-7
30		30	
24		10	
2.5	AWG 26...12	AWG 26...12	
0.8 kV / 3			
A3 / V-0			



30 / 5

Rated connection

0.5...4 / 1.5...4
0.5...4
0.4...0.6 / (M 2.5)
7 / 0.6 x 3.5 mm

Type	Qty.	Order No.
DLI 2.5/LD-RT/PNP +- DB	50	1783980000
DLI 2.5/LD-GN/PNP +- DB	50	1783970000

Type	Qty.	Order No.
Q 2 DLI	24 A 50	1312500000
Q 3 DLI	24 A 50	1312600000
Q 4 DLI	24 A 50	1312700000
Q 10 DLI	24 A 20	1313100000
VQB 1.5/50 SW	17.5 A 5	1635120000
VQB 1.5/50 RT	17.5 A 5	1633290000
VQB 1.5/50 BL	17.5 A 5	1633280000
AP DLI 2.5 DB	20	1783550000
EW 35	50	0383560000
SDS 0.6X3.5X100	1	2749340000
TSCH 1	100	0319160000
DEK 5/6 MC NE WS	1000	1609820000

DLI 2.5 LD NPN

2.5 mm²

Initiator connection with LED

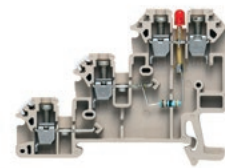

6.1 x 66 x 48.5
24 / 4
0.13...4

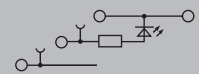

IEC 60947-7-1

IEC	UL	CSA	EN 60079-7
30		30	
24		10	
2.5	AWG 26...12	AWG 26...12	
0.8 kV / 3			
A3 / V-0			



30 / 5

Rated connection

0.5...4 / 1.5...4
0.5...4
0.4...0.6 / (M 2.5)
7 / 0.6 x 3.5 mm

Type	Qty.	Order No.
DLI 2.5/LD-RT/NPN +- DB	50	1783950000
DLI 2.5/LD-GN/NPN +- DB	50	1783940000

Type	Qty.	Order No.
Q 2 DLI	24 A 50	1312500000
Q 3 DLI	24 A 50	1312600000
Q 4 DLI	24 A 50	1312700000
Q 10 DLI	24 A 20	1313100000
VQB 1.5/50 SW	17.5 A 5	1635120000
VQB 1.5/50 RT	17.5 A 5	1633290000
VQB 1.5/50 BL	17.5 A 5	1633280000
AP DLI 2.5 DB	20	1783550000
EW 35	50	0383560000
SDS 0.6X3.5X100	1	2749340000
TSCH 1	100	0319160000
DEK 5/6 MC NE WS	1000	1609820000

Signal wiring
Screw connection



Width/Height/Depth	mm
max. current / max. cond. cross-section	A/mm ²
Max. clamping range	mm ²

Technical data

Rated data	
Rated voltage	V
Rated current	A
for wire cross-section	mm ²
Rated impulse withstand voltage / Pollution severity	
Gauge to IEC 60947-1 / UL 94 flammability rating	
Approvals	
Electronic fixtures	
Component voltage / Component current	-/-
Operating voltage for display, max. / Current	-/-
Clamped conductors (H05V/H07V)	
Solid / Stranded	mm ²
Flexible / Flexible with ferrule	mm ²
Tightening torque / Clamping screw	Nm
Stripping length / Blade size	mm/-
Note	

Ordering data

Version	dark beige dark beige (red LED) dark beige (green LED)
Note	

Accessories

Screwable cross-connection	
	2-pole
	3-pole
	4-pole
	10-pole
Cross-connector	
	black
	red
	blue
End plate / Partition plate	
	dark beige
End bracket	
	dark beige
Screwdriver	
	Standard
Small partition	
	Small partition
Marking tags	

For detailed information on other accessories and application in the online catalogue

DLA 2.5

2.5 mm²

Actuator connection (signal,-PE)

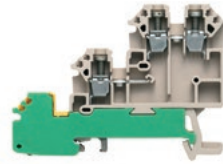

6.1 x 65 x 48.5
26 / 4
0.13...4

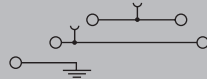

IEC 60947-7-1 (-7-2)

IEC	UL	CSA	EN 60079-7
250	300	300	
17.5	10	10	
2.5	AWG 26...12	AWG 26...12	
4 kV / 3			
A3 / V-0			



Rated connection

0.5...4 / 1.5...4
0.5...4
0.4...0.6 / (M 2.5)
7 / 0.6 x 3.5 mm

Rated voltage is reduced to 30 V AC when one pole with a different potential is skipped with a cross-connector.

Type	Qty.	Order No.
DLA 2.5 DB	100	1783560000

Type	Qty.	Order No.
Q 2 DLI	24 A 50	1312500000
Q 3 DLI	24 A 50	1312600000
Q 4 DLI	24 A 50	1312700000
Q 10 DLI	24 A 20	1313100000
VQB 1.5/50 SW	17.5 A 5	1635120000
VQB 1.5/50 RT	17.5 A 5	1633290000
VQB 1.5/50 BL	17.5 A 5	1633280000
AP DLI2.5 DB	20	1783550000
EW 35	50	0383560000
SDS 0.6X3.5X100	1	2749340000
TSCH 1	100	0319160000
DEK 5/6 MC NE WS	1000	1609820000

DLA 2.5/D

2.5 mm²

Actuator connection (circuit with diode)

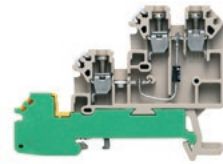

6.1 x 66 x 48.5
17.5 / 4
0.13...4

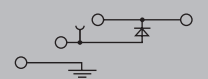

IEC 60947-7-1 (-7-2)

IEC	UL	CSA	EN 60079-7
250	300	300	
17.5	10	10	
2.5	AWG 26...12	AWG 26...12	
4 kV / 3			
A3 / V-0			



Rated connection

0.5...4 / 1.5...4
0.5...4
0.4...0.6 / (M 2.5)
7 / 0.6 x 3.5 mm

Rated voltage is reduced to 30 V AC when one pole with a different potential is skipped with a cross-connector.

Type	Qty.	Order No.
DLA 2.5/D DB	100	1783590000

Type	Qty.	Order No.
Q 2 DLI	24 A 50	1312500000
Q 3 DLI	24 A 50	1312600000
Q 4 DLI	24 A 50	1312700000
Q 10 DLI	24 A 20	1313100000
VQB 1.5/50 SW	17.5 A 5	1635120000
VQB 1.5/50 RT	17.5 A 5	1633290000
VQB 1.5/50 BL	17.5 A 5	1633280000
AP DLI2.5 DB	20	1783550000
EW 35	50	0383560000
SDS 0.6X3.5X100	1	2749340000
TSCH 1	100	0319160000
DEK 5/6 MC NE WS	1000	1609820000

For detailed information on other accessories and application in the online catalogue

DLA 2.5/LD

2.5 mm²

Actuator connection with LED

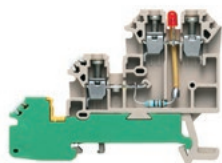

6.1 x 66 x 48.5
17.5 / 4
0.13...4

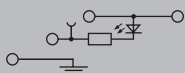

IEC 60947-7-1 (-7-2)

IEC	UL	CSA	EN 60079-7
30		30	
17.5		10	
2.5	AWG 26...12	AWG 26...12	
0.8 kV / 3			
A3 / V-0			

CE

30 / 5

Rated connection

0.5...4 / 1.5...4

0.5...4

0.4...0.6 / (M 2.5)

7 / 0.6 x 3.5 mm

Type	Qty.	Order No.
DLA 2.5/LD-RT DB	50	1783600000

Type	Qty.	Order No.
Q 2 DLI	24 A 50	1312500000
Q 3 DLI	24 A 50	1312600000
Q 4 DLI	24 A 50	1312700000
Q 10 DLI	24 A 20	1313100000
VQB 1.5/50 SW	17.5 A 5	1635120000
VQB 1.5/50 RT	17.5 A 5	1633290000
VQB 1.5/50 BL	17.5 A 5	1633280000
AP DLI2.5 DB	20	1783550000
EW 35	50	0383560000
SDS 0.6X3.5X100	1	2749340000
TSCH 1	100	0319160000
DEK 5/6 MC NE WS	1000	1609820000





WDU 2.5/TC

2.5 mm²



Width/Height/Depth	mm
max. current / max. cond. cross-section	-
Max. clamping range	mm ²

10.2 x 60 x 50	
/ 2.5	
0.13...2.5	

Ex eb II C GbII
2 G D

IEC 60584, IEC 60947-7-1

IEC	UL	CSA	EN 60079-7
	50		55
			8
2.5	AWG 30...12		2.5 mm ²
/ 3			
A2 / V-0			

SIRA 02ATEX3153 U

Technical data

Rated data	
Rated voltage to adjoining terminal	-
Rated current	-
for wire cross-section	mm ²
Rated impulse withstand voltage / Pollution severity	
Gauge to IEC 60947-1 / UL 94 flammability rating	
Approvals	
Clamped conductors (H05V/H07V)	
Solid / Stranded	mm ²
Flexible / Flexible with ferrule	mm ²
Tightening torque / Clamping screw	Nm
Stripping length / Blade size	mm/-

Rated connection	
0.5...2.5 / 1.5...2.5	
0.5...2.5 / 0.5...2.5	
0.4...0.6 / (M 2.5)	
10 / 0.6 x 3.5 mm	

Note

Ordering data

Version	
(NiCr - Ni) type K	
(Cu - CuNi) type T	
(Fe-CuNi) type J	
(Pt 10% - Pt Rh/Pt 13% - Pt Rh) type SR	
(Pt 10% Rh - Pt 6% Rh) type B	
(NiCr - CuNi) type E	
(NiSiI - Nicrosil) type N	

Type	Qty.	Order No.
WDU 2.5/TC TYP K	25	1024100000
WDU 2.5/TC TYP T	25	1024200000
WDU 2.5/TC TYP J	25	1024300000
WDU 2.5/TC TYP SR	25	1024400000
WDU 2.5/TC TYP B	25	1033700000
WDU 2.5/TC TYP E	25	1033300000
WDU 2.5/TC TYP N	25	1041500000

Note

Accessories

End plate / Partition plate	
	dark beige
	dark beige
End bracket	dark beige
Marking tags	dark beige

Type	Qty.	Order No.
WAP 2.5-10	50	1050000000
WAP 16*35 WTW 2.5-10	20	1050100000
WEW 35/2	50	1061200000
DEK 5/5 MC NE WS	1000	1609801044

Weidmüller thermocouple terminals are specially designed for the transmission of very small voltages in temperature measuring circuits. Special current bars ensure that no false signals are transmitted within the terminal when temperature differences between the positive and negative paths exist. This high measuring precision is required, for example, in aircraft engine test rigs, complicated chemical processes, controllers, etc.

- Material of current bar corresponds to thermal and compensating conductors
- Clear thermocouple marking
- 2-pole blocks per thermocouple
- Modular width 10 mm

Configuration of a temperature measuring circuit

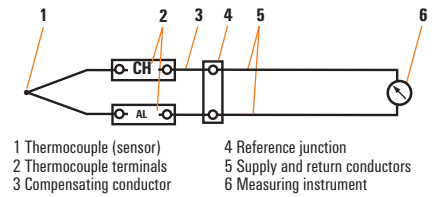

- 1 Thermocouple (sensor)
- 2 Thermocouple terminals
- 3 Compensating conductor
- 4 Reference junction
- 5 Supply and return conductors
- 6 Measuring instrument

The thermocouple terminals shown in this measuring circuit are used for the thermoelectrical transmission of the thermoelectric voltage from the thermocouple to the reference junction and the indicator unit via the compensating conductor. Thermocouple terminals are required for constructing a temperature measuring circuit.

Technical data

Thermocouples to IEC 584 (DIN 43 710)

For detailed information on other accessories and application in the online catalogue

WDU 2.5/TC TYP K

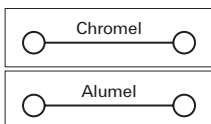

Type	Qty.	Order No.
WDU 2.5/TC TYP K	25	1024100000

WDU 2.5/AP/TC BL TYP K

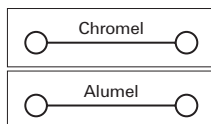

Type	Qty.	Order No.
WDU 2.5/AP/TC BL TYP K	25	1032880000

WDU 2.5/TC TYP T

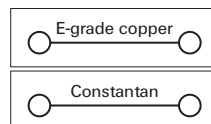
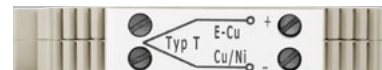

Type	Qty.	Order No.
WDU 2.5/TC TYP T	25	1024200000

WDU 2.5/TC TYP J

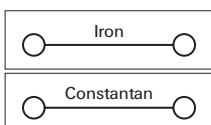
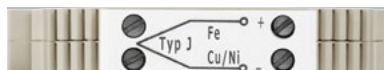

Type	Qty.	Order No.
WDU 2.5/TC TYP J	25	1024300000

WDU 2.5/TC TYP SR

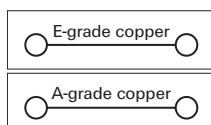

Type	Qty.	Order No.
WDU 2.5/TC TYP SR	25	1024400000

WDU 2.5/TC TYP B

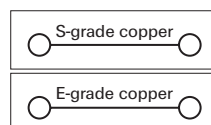
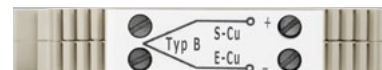
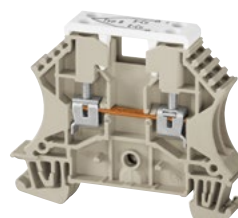

Type	Qty.	Order No.
WDU 2.5/TC TYP B	25	1033700000

WDU 2.5/TC TYP E

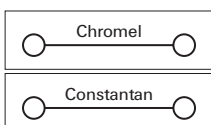

Type	Qty.	Order No.
WDU 2.5/TC TYP E	25	1033300000

WDU 2.5/TC TYP N

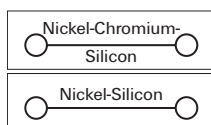

Type	Qty.	Order No.
WDU 2.5/TC TYP N	25	1041500000

B



Space-saving connection of process control systems

Efficient marshalling and distribution with Klippon® Connect signals



Increasingly complex requirements for automation processes and increasing demands in terms of monitoring and recording operational data have led to an ever-increasing number of sensors in the field for process technology. This means that space- and time-saving wiring of signals in Signal marshalling panels in the process and energy generation industries is becoming increasingly demanding. Our terminal blocks for Signal marshalling enable extremely compact yet clear panel design. The additional signals for automation can be easily connected and processed.

Our promise

With our terminal blocks for Signal marshalling, you have maximum flexibility from the planning phase: potential later extensions can be planned in from the start. This means that Klippon® Connect saves you time and money and considerably improves productivity.

B

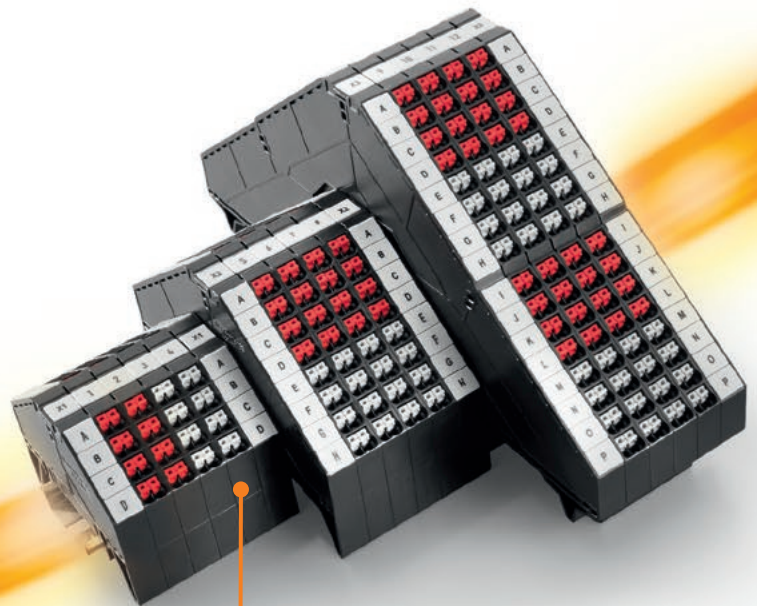
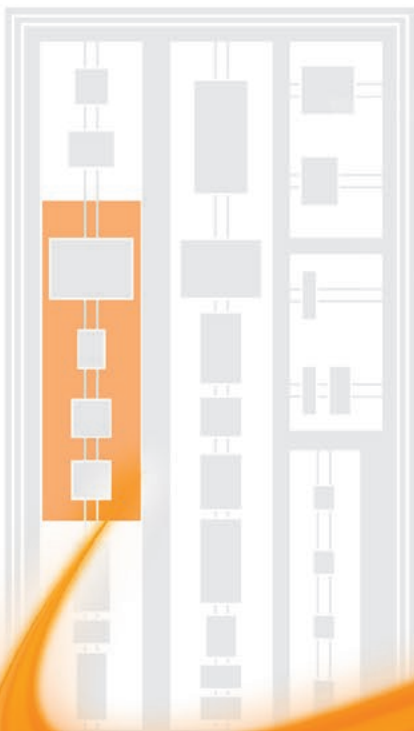

Space saving

- Up to 50 percent more space in the panel thanks to optimised design
- Subsequent design extensions can be considered from the outset

Time saving

- Fast and convenient fuse replacement thanks to fuse holder with hinged fuse lever
- A double or triple cross-connection channel ensures low wiring effort
- Digital data availability in CAD programs

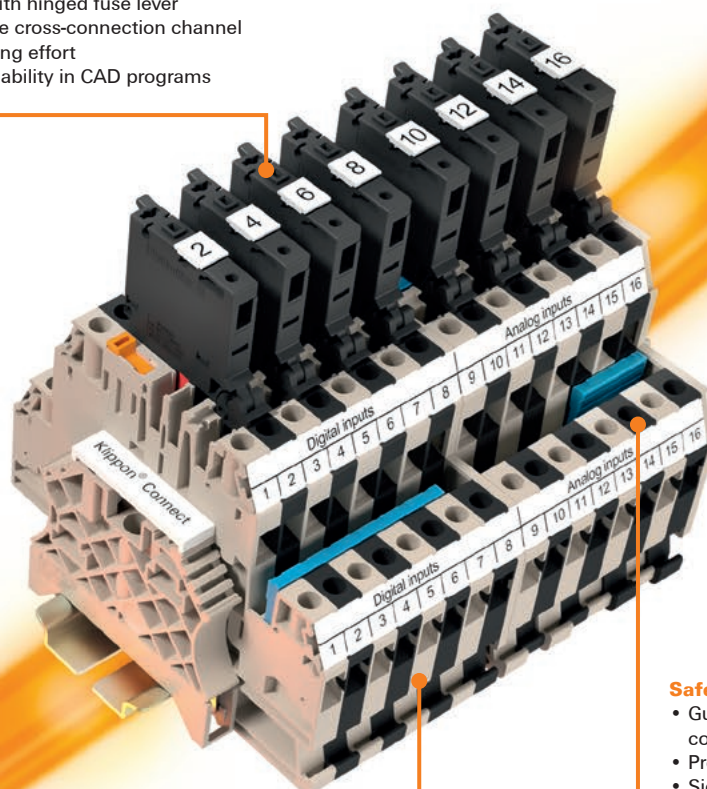
**Safety**

- Guaranteed vibration-proof and gas-tight connections
- Protection against electromagnetic influences
- Signal loops measurable when fuse lever is open

Flexibility

- A double or triple cross-connection channel provides smart potential distribution
- Last-minute function change possible
- Endless strip marker for large-area marking

Our range**Unique design for plenty of space:**

Our PUSH IN terminal blocks for Signal marshalling (PRV) with up to 16 connection levels are specially designed to meet the requirements for wiring initiator and actuator signals in process control engineering. The optimised design guarantees a space saving of up to 50 percent in the panel. And the unique V-shape of the current bars ensures consistently low contact resistances.

**One solution for all requirements:**

The WMF-Series of screw connection terminals is a multi-functional solution for the marshalling and distribution of signals. Feed-through, fuse and disconnecter function plus an additional shield connection are included in one design.



More flexibility in signal wiring and potential distribution

Klippon® Connect W2C and W2T Range for signal marshaling

Automation in the process industry requires flexible solutions for complex production processes. Your circuit diagrams are no less complex and often undergo changes shortly before the end. With our new range of DCS marshalling terminal blocks you can solve these challenges. Even a „last minute change“ is feasible for you without having to change the wiring you have already done. Thanks to the single- and double-level arrangement of the terminal blocks, combined with the provision of the four basic functions (continuity, disconnect, fuse, ground), you achieve maximum flexibility when connecting your devices wired in the field. We also offer you an alternative to connecting the shield to PE for your potential-free shielding concepts.

B

Cross connection channel provision

On all levels terminals the double cross connection possibility allows you a rational and comfortable potential distribution for Analogue and Digital inputs and outputs. The single level terminal blocks offer up to three cross connection channels.



Hollow screw head equipped versions

In order to ease and increase your efficiency in signal loop verifications, our „STB“ versions are equipped with tightening screws with hollow screw heads thus allowing direct and secure insertion of appropriate test probes in hands-free operations.

DCS
I/O

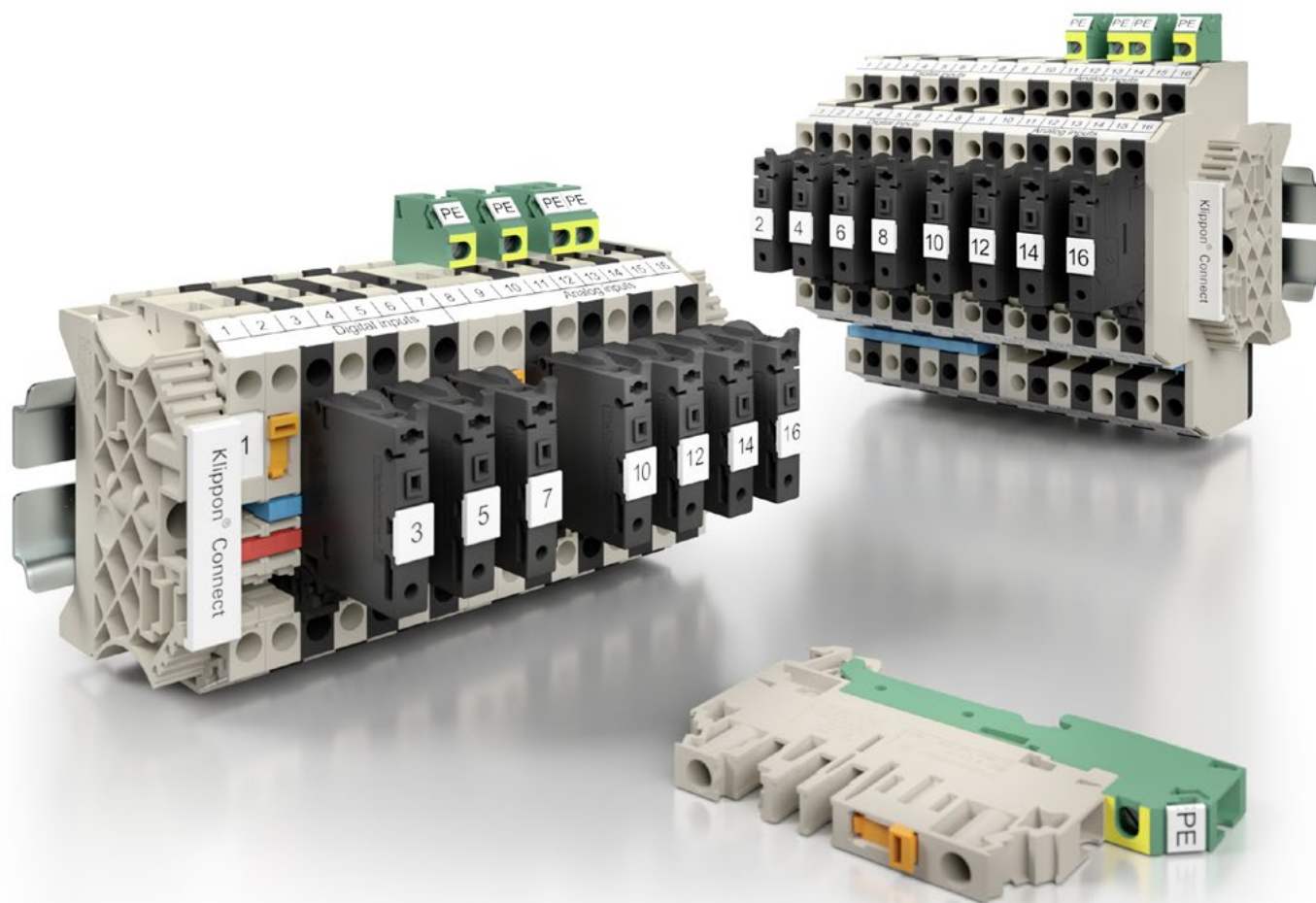

Signal loop testing

During your DCS marshalling signal loop checks, you can insert your probes need not only upstream and downstream the fuse in closed position you also can open the fuse carrier while your test probes are plugged. This allows you a make before break testing.



Data provision and rationalized accessory base

Full data provision in the Weidmüller Configurator (WMC), to enhance and streamline design-in process of the complete solution. The wizard guide helps to select the correct items of critical safety accessories in order to obtain a 100% safe and rationalized product configuration.

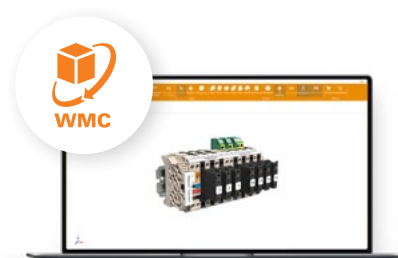

Plan, install, and operate optimally

Planning – with perfect support

Data provision and rationalized accessory base

Full data provision in the Weidmüller Configurator (WMC), to enhance and streamline design-in process of the complete solution. The wizard guide helps to select the correct items of critical safety accessories in order to obtain a 100% safe and rationalized product configuration.



B

Full range of international approvals

The new W2C / W2T range is equipped with the full spectrum of approvals qualifying its choice for use in Process-related hazardous, non-hazardous locations and on board of vessels for Marine applications.



Compact footprint

The new single and double tier range terminals offer you full breadth of functionality in a very limited footprint, thus allowing maximum signal wiring density in a cabinet. In the case of the 2 level terminal block, up to 3 different electrical functions can be implemented (fuse/disconnect, feed-through and PE).

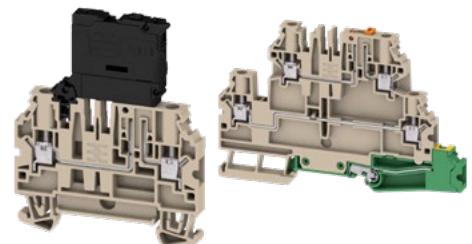

Reliable clamping yoke screw technology

Throughout the whole proposal the terminal blocks are equipped with Weidmüller's self-locking, maintenance free clamping yoke wiring technology. This has proven itself in decades of service life giving unrivalled connection safety and reliability inside the application.

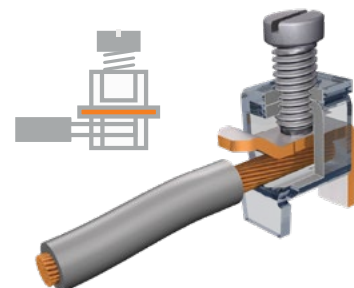

Plan, install, and operate optimally

Installation – simple, fast, and safe

Integrated PE contact for shielding

You can choose the new single and double tier terminals also with integrated PE contact onto the DIN rail to allow rational shield connection from incoming field wire cables. Thus allowing space and component savings in the cabinet.

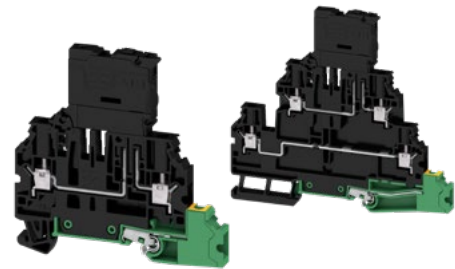

Integrated shield bus bar to be connected to your floating ground

As alternative to connecting the shield to PE you can use the potential-free shield bus bar. You can use this as integrated part of a single tier terminal block which saves you space and costs. It allows you to use your floating ground for the shield that avoids a coupling loop for noise currents present in the ground system.



Cross connection channel provision

On all levels terminals the double cross connection possibility allows you a rational and comfortable potential distribution for Analogue and Digital inputs and outputs. The single level terminal blocks offer up to three cross connection channels.



Function change – Last minute changes

The disconnect and fuse versions can allow you an easy function change by replacing disconnect lever with hinged fuse carrier or vice versa, thus accommodating late minute changes in cabinets. Your wire installation can remain unchanged.

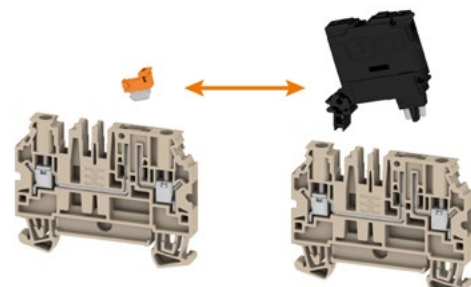

Plan, install, and operate optimally

Operation – norm-compliant and safe

Hollow screw head equipped versions

In order to ease and increase your efficiency in signal loop verifications, our “STB” versions are equipped with tightening screws with hollow screw heads thus allowing direct and secure insertion of appropriate test probes in hands-free operations.



Signal loop testing

During your DCS marshalling signal loop checks, you can insert your probes need not only upstream and downstream the fuse in closed position you also can open the fuse carrier while your test probes are plugged. This allows you a make before break testing.



Additional marking and enhanced potential distribution possibility

You can use the multi-functional channel on the left to equip a marker holder or you can use it for a third cross-connection, providing one common feeding for adjoining feed through and disconnect terminals.



Endless strip marker

The endless strip marker fits perfectly on the terminal rail. Without any pitch the marker could be fixed over every terminal block as well as endplates in one line. Thus allowed absolutely flexibility during the planning, installation and operation phase. Additionally the strip markers offers a big marking area for multiple lines.



W2C 4 FT

4 mm²

W2C 4 FT STB

4 mm²

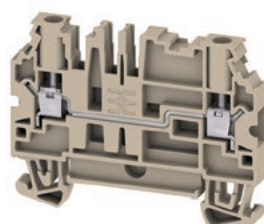

Q3
2023

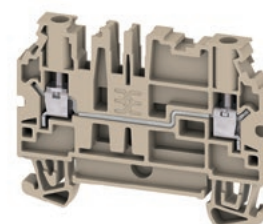

Q3
2023

Width/Height/Depth	mm
max. current / max. cond. cross-section	A/mm ²
Max. clamping range	mm ²

6.1 x 60 x 46
32 / 4
0.2...4



6.1 x 60 x 46
32 / 4
0.2...4

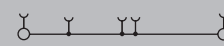

Technical data

Rated data	
Rated voltage	V
Rated current	A
for wire cross-section	mm ²
Rated impulse withstand voltage / Pollution severity	
Gauge to IEC 60947-1 / UL 94 flammability rating	
Approvals	
Clamped conductors (H05V/H07V)	
Solid / Stranded	mm ²
Flexible / Flexible with ferrule	mm ²
Twin wire-end ferrule	mm ²
Stripping length / Blade size	mm/-

IEC 60947-7-1			
IEC	UL	CSA	EN 60079-7
800			
32			
4			
	8 kV / 3		
	A3 / V-0		
Rated connection			
0.5...4 / 0.5...4			
0.5...4 / 0.5...4			
0.5...1.5			
8 / 0.6 x 3.5 mm			

IEC 60947-7-1			
IEC	UL	CSA	EN 60079-7
800			
32			
4			
	8 kV / 3		
	A3 / V-0		
Rated connection			
0.5...4 / 0.5...4			
0.5...4 / 0.5...4			
0.5...1.5			
8 / 0.6 x 3.5 mm			

Note

Ordering data

Version	
	dark beige
	Blue
	Black

Note

Type	Qty.	Order No.
W2C 4 FT		2892650000
W2C 4 FT BL		2892660000
W2C 4 FT BK		2892670000

Type	Qty.	Order No.
W2C 4 FT STB		2892680000

Accessories

Plug-in cross-connection	
	2-pole
	10-pole
End plate	
	dark beige
	blue
	Black
End bracket	
	dark beige
Screwdriver	
	Standard
Marker holder	
	dark beige
Holder for cartridge fuse 5 x 20 mm	
	400 V AC/DC, without LED
	10 - 36 V AC/DC, red LED
	35 - 70 V AC/DC, red LED
	60 - 150 V AC/DC, red LED
	140 - 250 V AC/DC, red LED
Disconnect plug	
	orange
Module connector (max, 250 V)	
	without fittings
	With 1N4007 diode
	with wire jumper
Marking tags	
WS 8/6 MM WS	600 2007160000
DEK 5/6 MM WS	600 2007120000
DEK 5/6 PLUS MC NE WS	1000 1011320000
DEK 5/5 MC NE WS	1000 1609801044

For detailed information on other accessories and application in the online catalogue

Type	Qty.	Order No.
ZQV 4N/2	32 A 60	1527930000
ZQV 4N/10	32 A 20	1528090000
WEP 2C 4		2894210000
WEP 2C 4 BL		2894220000
WEP 2C 4 BK		2894230000
WEW 35/2	50	1061200000
SDS 0.6X3.5X100	1	2749340000
BZT W2C 4		2894270000
WS 8/6 MM WS	600	2007160000
DEK 5/6 MM WS	600	2007120000
DEK 5/6 PLUS MC NE WS	1000	1011320000
DEK 5/5 MC NE WS	1000	1609801044

Type	Qty.	Order No.
ZQV 4N/2	32 A 60	1527930000
ZQV 4N/10	32 A 20	1528090000
WEP 2C 4		2894210000
WEP 2C 4 BL		2894220000
WEP 2C 4 BK		2894230000
WEW 35/2	50	1061200000
SDS 0.6X3.5X100	1	2749340000
BZT W2C 4		2894270000
WS 8/6 MM WS	600	2007160000
DEK 5/6 MM WS	600	2007120000
DEK 5/6 PLUS MC NE WS	1000	1011320000
DEK 5/5 MC NE WS	1000	1609801044



W2C 4 FT-PE

4 mm²

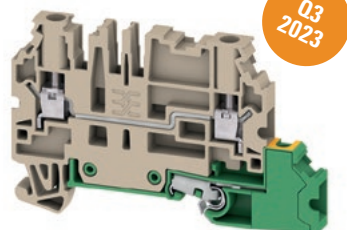

W2C 4 FT-PE STB

4 mm²

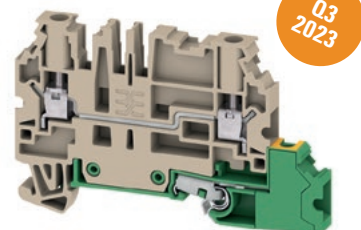

Width/Height/Depth	mm
max. current / max. cond. cross-section	A/mm ²
Max. clamping range	mm ²

6.1 x 72.5 x 46	
32 / 4	
0.2...4	

6.1 x 72.5 x 46	
32 / 4	
0.2...4	

Technical data

Rated data	
Rated voltage	V
Rated current	A
for wire cross-section	mm ²
Rated impulse withstand voltage / Pollution severity	
Gauge to IEC 60947-1 / UL 94 flammability rating	
Approvals	
Clamped conductors (H05V/H07V)	
Solid / Stranded	mm ²
Flexible / Flexible with ferrule	mm ²
Twin wire-end ferrule	mm ²
Stripping length / Blade size	mm/-

IEC 60947-7-1			
IEC	UL	CSA	EN 60079-7
800			
32			
4			
	8 kV / 3		
	A3 / V-0		

IEC 60947-7-1			
IEC	UL	CSA	EN 60079-7
800			
32			
4			
	8 kV / 3		
	A3 / V-0		

Note

Note

Note

Ordering data

Version	
	dark beige
	Blue
	Black

Type	Qty.	Order No.
W2C 4 FT-PE		2892690000

Type	Qty.	Order No.
W2C 4 FT-PE STB		2892700000

Accessories

Plug-in cross-connection	
	2-pole
	10-pole
End plate	
	dark beige
	blue
	Black
End bracket	
	dark beige
Screwdriver	
	Standard
Marker holder	
	dark beige
Holder for cartridge fuse 5 x 20 mm	
	400 V AC/DC, without LED
	10 - 36 V AC/DC, red LED
	35 - 70 V AC/DC, red LED
	60 - 150 V AC/DC, red LED
	140 - 250 V AC/DC, red LED
Disconnect plug	
	orange
Module connector (max, 250 V)	
	without fittings
	With 1N4007 diode
	with wire jumper
Marking tags	
	WS 8/6 MM WS
	DEK 5/6 MM WS
	DEK 5/6 PLUS MC NE WS
	DEK 5/5 MC NE WS

Type	Qty.	Order No.
ZQV 4N/2	32 A 60	1527930000
ZQV 4N/10	32 A 20	1528090000
WEP 2C 4		2894210000
WEP 2C 4 BL		2894220000
WEP 2C 4 BK		2894230000
WEW 35/2	50	1061200000
SDS 0.6X3.5X100	1	2749340000
BZT W2C 4		2894270000
WS 8/6 MM WS	600	2007160000
DEK 5/6 MM WS	600	2007120000
DEK 5/6 PLUS MC NE WS	1000	1011320000
DEK 5/5 MC NE WS	1000	1609801044

Type	Qty.	Order No.
ZQV 4N/2	32 A 60	1527930000
ZQV 4N/10	32 A 20	1528090000
WEP 2C 4		2894210000
WEP 2C 4 BL		2894220000
WEP 2C 4 BK		2894230000
WEW 35/2	50	1061200000
SDS 0.6X3.5X100	1	2749340000
BZT W2C 4		2894270000
WS 8/6 MM WS	600	2007160000
DEK 5/6 MM WS	600	2007120000
DEK 5/6 PLUS MC NE WS	1000	1011320000
DEK 5/5 MC NE WS	1000	1609801044

For detailed information on other accessories and application in the online catalogue

For detailed information on other accessories and application in the online catalogue

W2C 4 DT

4 mm²

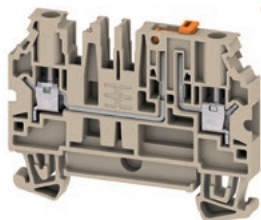

Q3
2023

6.1 x 60 x 48
20 / 4
0.2...4

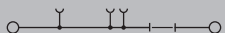

IEC 60947-7-1

IEC	UL	CSA	EN 60079-7
800			
32			
4			
8 kV / 3			
A3 / V-0			

Rated connection

0.5...4 / 0.5...4
0.5...4 / 0.5...4
0.5...1.5
8 / 0.6 x 3.5 mm

Type	Qty.	Order No.
W2C 4 DT		2892740000
W2C 4 DT BL		2892750000
W2C 4 DT BK		2892760000

Type	Qty.	Order No.
ZQV 4N/2	32 A 60	1527930000
ZQV 4N/10	32 A 20	1528090000
WEP 2C 4		2894210000
WEP 2C 4 BL		2894220000
WEP 2C 4 BK		2894230000
WEW 35/2	50	1061200000
SDS 0.6X3.5X100	1	2749340000
BZT W2C 4		2894270000
SIHA 3/G20	6.3 A 25	7921560000
SIHA 3/G20/LD 10-36V	25	7921570000
SIHA 3/G20/LD 35-70V	25	7921580000
SIHA 3/G20/LD 60-150V	25	7921590000
SIHA 3/G20/LD 140-250V	25	7921600000
TNST OR	20 A 50	2463540000
BEST	50	1833100000
BEST/D	1 A 50	1878560000
BEST/DRBR	22 A 50	1878570000
WS 8/6 MM WS	600	2007160000
DEK 5/6 MM WS	600	2007120000
DEK 5/6 PLUS MC NE WS	1000	1011320000
DEK 5/5 MC NE WS	1000	1609801044

W2C 4 DT STB

4 mm²

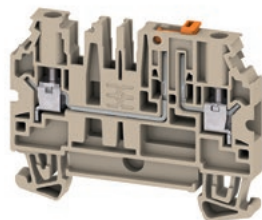

Q3
2023

6.1 x 60 x 48
20 / 4
0.2...4



IEC 60947-7-1

IEC	UL	CSA	EN 60079-7
800			
32			
4			
8 kV / 3			
A3 / V-0			

Rated connection

0.5...4 / 0.5...4
0.5...4 / 0.5...4
0.5...1.5
8 / 0.6 x 3.5 mm

Type	Qty.	Order No.
W2C 4 DT STB		2892770000

Type	Qty.	Order No.
ZQV 4N/2	32 A 60	1527930000
ZQV 4N/10	32 A 20	1528090000
WEP 2C 4		2894210000
WEP 2C 4 BL		2894220000
WEP 2C 4 BK		2894230000
WEW 35/2	50	1061200000
SDS 0.6X3.5X100	1	2749340000
BZT W2C 4		2894270000
SIHA 3/G20	6.3 A 25	7921560000
SIHA 3/G20/LD 10-36V	25	7921570000
SIHA 3/G20/LD 35-70V	25	7921580000
SIHA 3/G20/LD 60-150V	25	7921590000
SIHA 3/G20/LD 140-250V	25	7921600000
TNST OR	20 A 50	2463540000
BEST	50	1833100000
BEST/D	1 A 50	1878560000
BEST/DRBR	22 A 50	1878570000
WS 8/6 MM WS	600	2007160000
DEK 5/6 MM WS	600	2007120000
DEK 5/6 PLUS MC NE WS	1000	1011320000
DEK 5/5 MC NE WS	1000	1609801044

B



Signal marshalling

PUSH IN connection

W2C 4 DT W/O DTLV

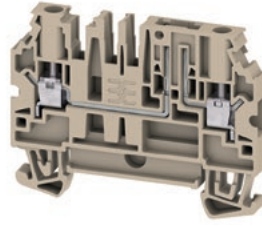
4 mm²Q3
2023

Width/Height/Depth	mm
max. current / max. cond. cross-section	A/mm ²
Max. clamping range	mm ²

6.1 x 60 x 48
20 / 4
0.2...4



Technical data

Rated data	
Rated voltage	V
Rated current	A
for wire cross-section	mm ²
Rated impulse withstand voltage / Pollution severity	
Gauge to IEC 60947-1 / UL 94 flammability rating	
Approvals	
Clamped conductors (H05V/H07V)	
Solid / Stranded	mm ²
Flexible / Flexible with ferrule	mm ²
Twin wire-end ferrule	mm ²
Stripping length / Blade size	mm/-

IEC 60947-7-1

IEC	UL	CSA	EN 60079-7
800			
32			
4			
	8 kV / 3		
	A3 / V-0		

Rated connection

0.5...4 / 0.5...4
0.5...4 / 0.5...4
0.5...1.5
8 / 0.6 x 3.5 mm

Note

Ordering data

Version	
	without isolator, dark beige
	without isolator, black
	without isolator, blue

Note

Type	Qty.	Order No.
W2C 4 DT W/O DTLV		2892780000
W2C 4 DT W/O DTLV BK		2892800000
W2C 4 DT W/O DTLV BL		2892790000

Accessories

Plug-in cross-connection	
	2-pole
	10-pole

End plate	
	dark beige
	blue
	Black

End bracket	
	dark beige

Screwdriver	
	Standard

Marker holder	
	dark beige

Holder for cartridge fuse 5 x 20 mm	
	400 V AC/DC, without LED
	10 - 36 V AC/DC, red LED
	35 - 70 V AC/DC, red LED
	60 - 150 V AC/DC, red LED
	140 - 250 V AC/DC, red LED

Disconnect plug	
	orange

Module connector (max, 250 V)	
	without fittings
	With 1N4007 diode
	with wire jumper

Marking tags

Type	Qty.	Order No.
ZQV 4N/2	32 A 60	1527930000
ZQV 4N/10	32 A 20	1528090000

WEP 2C 4		2894210000
WEP 2C 4 BL		2894220000
WEP 2C 4 BK		2894230000

WEW 35/2	50	1061200000
----------	----	------------

SDS 0.6X3.5X100	1	2749340000
-----------------	---	------------

BZT W2C 4		2894270000
-----------	--	------------

SIHA 3/G20	6.3 A 25	7921560000
SIHA 3/G20/LD 10-36V	25	7921570000
SIHA 3/G20/LD 35-70V	25	7921580000
SIHA 3/G20/LD 60-150V	25	7921590000
SIHA 3/G20/LD 140-250V	25	7921600000

TNST OR	20 A 50	2463540000
---------	---------	------------

BEST	50	1833100000
------	----	------------

BEST/D	1 A 50	1878560000
--------	--------	------------

BEST/DRBR	22 A 50	1878570000
-----------	---------	------------

WS 8/6 MM WS	600	2007160000
--------------	-----	------------

DEK 5/6 MM WS	600	2007120000
---------------	-----	------------

DEK 5/6 PLUS MC NE WS	1000	1011320000
-----------------------	------	------------

DEK 5/5 MC NE WS	1000	1609801044
------------------	------	------------

For detailed information on other accessories and application in the online catalogue

W2C 4 DT-PE

4 mm²

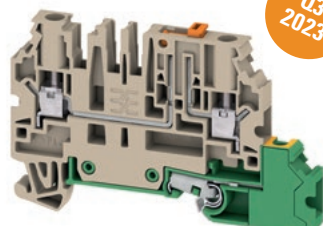

W2C 4 DT-PE STB

4 mm²

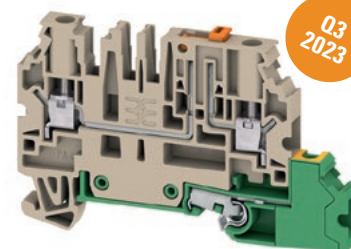

Width/Height/Depth	mm
max. current / max. cond. cross-section	A/mm ²
Max. clamping range	mm ²

6.1 x 72.5 x 48	
20 / 4	
0.2...4	

6.1 x 72.5 x 48	
20 / 4	
0.2...4	

Technical data

Rated data	
Rated voltage	V
Rated current	A
for wire cross-section	mm ²
Rated impulse withstand voltage / Pollution severity	
Gauge to IEC 60947-1 / UL 94 flammability rating	
Approvals	
Clamped conductors (H05V/H07V)	
Solid / Stranded	mm ²
Flexible / Flexible with ferrule	mm ²
Twin wire-end ferrule	mm ²
Stripping length / Blade size	mm/-

IEC 60947-7-1			
IEC	UL	CSA	EN 60079-7
800			
32			
4			
	8 kV / 3		
	A3 / V-0		
Rated connection			
0.5...4 / 0.5...4			
0.5...4 / 0.5...4			
0.5...1.5			
8 / 0.6 x 3.5 mm			

IEC 60947-7-1			
IEC	UL	CSA	EN 60079-7
800			
32			
4			
	8 kV / 3		
	A3 / V-0		
Rated connection			
0.5...4 / 0.5...4			
0.5...4 / 0.5...4			
0.5...1.5			
8 / 0.6 x 3.5 mm			

Note

Ordering data

Version	
	dark beige
Note	

Type	Qty.	Order No.
W2C 4 DT-PE		2892810000

Type	Qty.	Order No.
W2C 4 DT-PE STB		2892820000

Accessories

Plug-in cross-connection	
	2-pole
	10-pole
End plate	
	dark beige
	blue
	Black
End bracket	
	dark beige
Screwdriver	
	Standard
Marker holder	
	dark beige
Holder for cartridge fuse 5 x 20 mm	
	400 V AC/DC, without LED
	10 - 36 V AC/DC, red LED
	35 - 70 V AC/DC, red LED
	60 - 150 V AC/DC, red LED
	140 - 250 V AC/DC, red LED
Disconnect plug	
	orange
Module connector (max, 250 V)	
	without fittings
	With 1N4007 diode
	with wire jumper
Marking tags	

Type	Qty.	Order No.
ZQV 4N/2	32 A 60	1527930000
ZQV 4N/10	32 A 20	1528090000
WEP 2C 4		2894210000
WEP 2C 4 BL		2894220000
WEP 2C 4 BK		2894230000
WEW 35/2	50	1061200000
SDS 0.6X3.5X100	1	2749340000
BZT W2C 4		2894270000
SIHA 3/G20	6.3 A 25	7921560000
SIHA 3/G20/LD 10-36V	25	7921570000
SIHA 3/G20/LD 35-70V	25	7921580000
SIHA 3/G20/LD 60-150V	25	7921590000
SIHA 3/G20/LD 140-250V	25	7921600000
TNST OR	20 A 50	2463540000
BEST	50	1833100000
BEST/D	1 A 50	1878560000
BEST/DRBR	22 A 50	1878570000
WS 8/6 MM WS	600	2007160000
DEK 5/6 MM WS	600	2007120000
DEK 5/6 PLUS MC NE WS	1000	1011320000
DEK 5/5 MC NE WS	1000	1609801044

Type	Qty.	Order No.
ZQV 4N/2	32 A 60	1527930000
ZQV 4N/10	32 A 20	1528090000
WEP 2C 4		2894210000
WEP 2C 4 BL		2894220000
WEP 2C 4 BK		2894230000
WEW 35/2	50	1061200000
SDS 0.6X3.5X100	1	2749340000
BZT W2C 4		2894270000
SIHA 3/G20	6.3 A 25	7921560000
SIHA 3/G20/LD 10-36V	25	7921570000
SIHA 3/G20/LD 35-70V	25	7921580000
SIHA 3/G20/LD 60-150V	25	7921590000
SIHA 3/G20/LD 140-250V	25	7921600000
TNST OR	20 A 50	2463540000
BEST	50	1833100000
BEST/D	1 A 50	1878560000
BEST/DRBR	22 A 50	1878570000
WS 8/6 MM WS	600	2007160000
DEK 5/6 MM WS	600	2007120000
DEK 5/6 PLUS MC NE WS	1000	1011320000
DEK 5/5 MC NE WS	1000	1609801044

For detailed information on other accessories and application in the online catalogue

W2C 4 FS DB

4 mm²



Q3
2023

W2C 4 FS BL

4 mm²

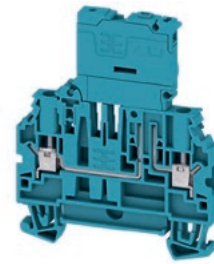

Q3
2023

Width/Height/Depth	mm
max. current / max. cond. cross-section	A/mm ²
Max. clamping range	mm ²

6.1 x 60 x 75
6.3 / 4
0.2...4

6.1 x 60 x 75
6.3 / 4
0.2...4

Technical data

Rated data	
Rated voltage	V
Rated current	A
for wire cross-section	mm ²
Rated impulse withstand voltage / Pollution severity	
Gauge to IEC 60947-1 / UL 94 flammability rating	
Approvals	
Clamped conductors (H05V/H07V)	
Solid / Stranded	mm ²
Flexible / Flexible with ferrule	mm ²
Twin wire-end ferrule	mm ²
Stripping length / Blade size	mm/-

IEC 60947-7-3			
IEC	UL	CSA	EN 60079-7
250			
6.3			
4			
	8 kV / 3		
	A3 / V-0		
Rated connection			
0.5...4 / 0.5...4			
0.5...4 / 0.5...4			
0.5...1.5			
8 / 0.6 x 3.5 mm			

IEC 60947-7-3			
IEC	UL	CSA	EN 60079-7
250			
6.3			
4			
	8 kV / 3		
	A3 / V-0		
Rated connection			
0.5...4 / 0.5...4			
0.5...4 / 0.5...4			
0.5...1.5			
8 / 0.6 x 3.5 mm			

Note

Ordering data

Version	500 V AC/DC, without LED 10-36 V AC/DC, with LED 30-70 V AC/DC, with LED 60-150 V AC/DC, with LED 100 - 250 V AC/DC, with LED
Note	

Type	Qty.	Order No.
W2C 4 FS DB		2892900000
W2C 4 FS 10-36V DB		2892980000
W2C 4 FS 30-70V DB		2893010000
W2C 4 FS 60-150V DB		2893040000
W2C 4 FS 100-250V DB		2893080000

Type	Qty.	Order No.
W2C 4 FS BL		2892910000
W2C 4 FS 10-36V BL		2892990000
W2C 4 FS 30-70V BL		2893020000
W2C 4 FS 60-150V BL		2893050000
W2C 4 FS 100-250V BL		2893090000

Accessories

Plug-in cross-connection	2-pole 10-pole
End plate	dark beige blue Black
End bracket	dark beige
Screwdriver	Standard
G-fuse cartridge, 5 x 20 mm (IEC 60127-2)	0.25 A fast 0.50 A fast 1.00 A fast 2.00 A fast
Marking tags	

Type	Qty.	Order No.
ZQV 4N/2	32 A 60	1527930000
ZQV 4N/10	32 A 20	1528090000
WEP 2C 4		
WEP 2C 4		2894210000
WEP 2C 4 BL		2894220000
WEP 2C 4 BK		2894230000
WEW 35/2		
WEW 35/2	50	1061200000
SDS 0.6X3.5X100		
SDS 0.6X3.5X100	1	2749340000
G 20/0.25A/F		
G 20/0.25A/F	0.25 A 10	0430500000
G 20/0.50A/F	0.5 A 10	0430600000
G 20/1.00A/F	1 A 10	0430700000
G 20/2.00A/F	2 A 10	0430900000
WS 8/6 MM WS		
WS 8/6 MM WS	600	2007160000
DEK 5/6 MM WS		
DEK 5/6 MM WS	600	2007120000
DEK 5/6 PLUS MC NE WS		
DEK 5/6 PLUS MC NE WS	1000	1011320000
DEK 5/5 MC NE WS		
DEK 5/5 MC NE WS	1000	1609801044

Type	Qty.	Order No.
ZQV 4N/2	32 A 60	1527930000
ZQV 4N/10	32 A 20	1528090000
WEP 2C 4		
WEP 2C 4		2894210000
WEP 2C 4 BL		2894220000
WEP 2C 4 BK		2894230000
WEW 35/2		
WEW 35/2	50	1061200000
SDS 0.6X3.5X100		
SDS 0.6X3.5X100	1	2749340000
G 20/0.25A/F		
G 20/0.25A/F	0.25 A 10	0430500000
G 20/0.50A/F	0.5 A 10	0430600000
G 20/1.00A/F	1 A 10	0430700000
G 20/2.00A/F	2 A 10	0430900000
WS 8/6 MM WS		
WS 8/6 MM WS	600	2007160000
DEK 5/6 MM WS		
DEK 5/6 MM WS	600	2007120000
DEK 5/6 PLUS MC NE WS		
DEK 5/6 PLUS MC NE WS	1000	1011320000
DEK 5/5 MC NE WS		
DEK 5/5 MC NE WS	1000	1609801044

For detailed information on other accessories and application in the online catalogue

W2C 4 FS BK

4 mm²

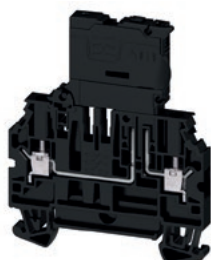

Q3
2023

6.1 x 60 x 75
6.3 / 4
0.2...4

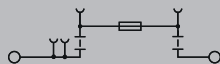

IEC 60947-7-3

IEC	UL	CSA	EN 60079-7
250			
6.3			
4			
8 kV / 3			
A3 / V-0			

Rated connection

0.5...4 / 0.5...4
0.5...4 / 0.5...4
0.5...1.5
8 / 0.6 x 3.5 mm

Type	Qty.	Order No.
W2C 4 FS BK		2892920000
W2C 4 FS 10-36V BK		2893000000
W2C 4 FS 30-70V BK		2893030000
W2C 4 FS 60-150V BK		2893070000
W2C 4 FS 100-250V BK		2893110000

Type	Qty.	Order No.
ZQV 4N/2	32 A 60	1527930000
ZQV 4N/10	32 A 20	1528090000
WEP 2C 4		2894210000
WEP 2C 4 BL		2894220000
WEP 2C 4 BK		2894230000
WEW 35/2	50	1061200000
SDS 0.6X3.5X100	1	2749340000
G 20/0.25A/F	0.25 A 10	0430500000
G 20/0.50A/F	0.5 A 10	0430600000
G 20/1.00A/F	1 A 10	0430700000
G 20/2.00A/F	2 A 10	0430900000
WS 8/6 MM WS	600	2007160000
DEK 5/6 MM WS	600	2007120000
DEK 5/6 PLUS MC NE WS	1000	1011320000
DEK 5/5 MC NE WS	1000	1609801044

W2C 4 FS BK STB

4 mm²

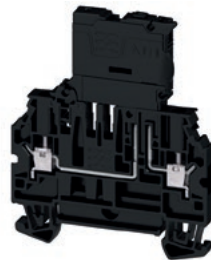

Q3
2023

6.1 x 60 x 75
6.3 / 4
0.2...4

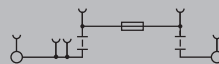

IEC 60947-7-3

IEC	UL	CSA	EN 60079-7
250			
6.3			
4			
8 kV / 3			
A3 / V-0			

Rated connection

0.5...4 / 0.5...4
0.5...4 / 0.5...4
0.5...1.5
8 / 0.6 x 3.5 mm

Type	Qty.	Order No.
W2C 4 FS BK STB		2892930000
W2C 4 FS 10-36V BK STB		2892940000
W2C 4 FS 30-70V BK STB		2892950000
W2C 4 FS 60-150V BK STB		2892960000
W2C 4 FS 100-250V BK STB		2892970000

Type	Qty.	Order No.
ZQV 4N/2	32 A 60	1527930000
ZQV 4N/10	32 A 20	1528090000
WEP 2C 4		2894210000
WEP 2C 4 BL		2894220000
WEP 2C 4 BK		2894230000
WEW 35/2	50	1061200000
SDS 0.6X3.5X100	1	2749340000
G 20/0.25A/F	0.25 A 10	0430500000
G 20/0.50A/F	0.5 A 10	0430600000
G 20/1.00A/F	1 A 10	0430700000
G 20/2.00A/F	2 A 10	0430900000
WS 8/6 MM WS	600	2007160000
DEK 5/6 MM WS	600	2007120000
DEK 5/6 PLUS MC NE WS	1000	1011320000
DEK 5/5 MC NE WS	1000	1609801044

W2C 4 FS-PE BK

4 mm²

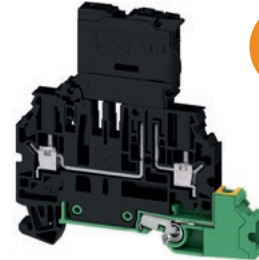

Q3
2023

6.1 x 72.5 x 75
6.3 / 4
0.2...4

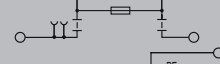

IEC 60947-7-3

IEC	UL	CSA	EN 60079-7
250			
6.3			
4			
8 kV / 3			
A3 / V-0			

Rated connection

0.5...4 / 0.5...4
0.5...4 / 0.5...4
0.5...1.5
8 / 0.6 x 3.5 mm

Type	Qty.	Order No.
W2C 4 FS-PE BK		2893120000
W2C 4 FS-PE 10-36V BK		2893140000
W2C 4 FS-PE 30-70V BK		2893150000
W2C 4 FS-PE 60-150V BK		2893160000
W2C 4 FS-PE 100-250V BK		2893170000

Type	Qty.	Order No.
ZQV 4N/2	32 A 60	1527930000
ZQV 4N/10	32 A 20	1528090000
WEP 2C 4		2894210000
WEP 2C 4 BL		2894220000
WEP 2C 4 BK		2894230000
WEW 35/2	50	1061200000
SDS 0.6X3.5X100	1	2749340000
G 20/0.25A/F	0.25 A 10	0430500000
G 20/0.50A/F	0.5 A 10	0430600000
G 20/1.00A/F	1 A 10	0430700000
G 20/2.00A/F	2 A 10	0430900000
WS 8/6 MM WS	600	2007160000
DEK 5/6 MM WS	600	2007120000
DEK 5/6 PLUS MC NE WS	1000	1011320000
DEK 5/5 MC NE WS	1000	1609801044

W2C 4 FS-PE BK STB

4 mm²

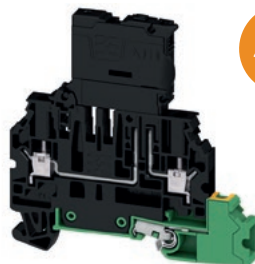

Q3
2023

Width/Height/Depth	mm
max. current / max. cond. cross-section	A/mm ²
Max. clamping range	mm ²

6.1 x 72.5 x 75
6.3 / 4
0.2...4

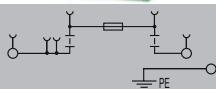

Technical data

Rated data	
Rated voltage	V
Rated current	A
for wire cross-section	mm ²
Rated impulse withstand voltage / Pollution severity	
Gauge to IEC 60947-1 / UL 94 flammability rating	
Approvals	
Clamped conductors (H05V/H07V)	
Solid / Stranded	mm ²
Flexible / Flexible with ferrule	mm ²
Twin wire-end ferrule	mm ²
Stripping length / Blade size	mm/-

IEC 60947-7-3

IEC	UL	CSA	EN 60079-7
250			
6.3			
4			
		8 kV / 3	
		A3 / V-0	

Rated connection	
0.5...4 / 0.5...4	
0.5...4 / 0.5...4	
0.5...1.5	
8 / 0.6 x 3.5 mm	

Note

Ordering data

Version	
500 V AC/DC, without LED	
10-36 V AC/DC, with LED	
30-70 V AC/DC, with LED	
60-150 V AC/DC, with LED	
100 - 250 V AC/DC, with LED	

Note

Type	Qty.	Order No.
W2C 4 FS-PE BK STB		2893130000
W2C 4 FS-PE 10-36V BK STB		2893180000
W2C 4 FS-PE 30-70V BK STB		2893190000
W2C 4 FS-PE 60-150V BK STB		2893200000
W2C 4 FS-PE 100-250V BK STB		2893210000

Accessories

Plug-in cross-connection	
	2-pole
	10-pole
End plate	
	dark beige
	blue
	Black
End bracket	
	dark beige
Screwdriver	
	Standard
G-fuse cartridge, 5 x 20 mm (IEC 60127-2)	
	0.25 A fast
	0.50 A fast
	1.00 A fast
	2.00 A fast
Marking tags	

Type	Qty.	Order No.
ZQV 4N/2	32 A 60	1527930000
ZQV 4N/10	32 A 20	1528090000
WEP 2C 4		2894210000
WEP 2C 4 BL		2894220000
WEP 2C 4 BK		2894230000
WEW 35/2	50	1061200000
SDS 0.6X3.5X100	1	2749340000
G 20/0.25A/F	0.25 A 10	0430500000
G 20/0.50A/F	0.5 A 10	0430600000
G 20/1.00A/F	1 A 10	0430700000
G 20/2.00A/F	2 A 10	0430900000
WS 8/6 MM WS	600	2007160000
DEK 5/6 MM WS	600	2007120000
DEK 5/6 PLUS MC NE WS	1000	1011320000
DEK 5/5 MC NE WS	1000	1609801044

For detailed information on other accessories and application in the online catalogue

W2T 4 DT-FT

4 mm²

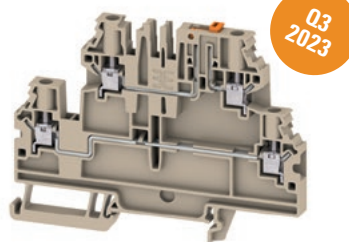

W2T 4 DT-FT STB

4 mm²

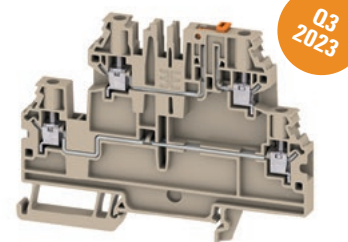

Width/Height/Depth	mm
max. current / max. cond. cross-section	A/mm ²
Max. clamping range	mm ²

6.1 x 95.5 x 72.5
20 / 4
0.2...4

6.1 x 95.5 x 72.5
20 / 4
0.2...4

Technical data

Rated data	
Rated voltage	V
Rated current	A
for wire cross-section	mm ²
Rated impulse withstand voltage / Pollution severity	
Gauge to IEC 60947-1 / UL 94 flammability rating	
Approvals	
Clamped conductors (H05V/H07V)	
Solid / Stranded	mm ²
Flexible / Flexible with ferrule	mm ²
Twin wire-end ferrule	mm ²
Stripping length / Blade size	mm/-

IEC 60947-7-1			
IEC	UL	CSA	EN 60079-7
500			
32			
4			
	6 kV / 3		
	A3 / V-0		
Rated connection			
0.5...4 / 0.5...4			
0.5...4 / 0.5...4			
0.5...1.5			
8 / 0.6 x 3.5 mm			

IEC 60947-7-1			
IEC	UL	CSA	EN 60079-7
500			
32			
4			
	6 kV / 3		
	A3 / V-0		
Rated connection			
0.5...4 / 0.5...4			
0.5...4 / 0.5...4			
0.5...1.5			
8 / 0.6 x 3.5 mm			

Note

Ordering data

Version	
	dark beige
	Blue
	Black

Note

Type	Qty.	Order No.
W2T 4 DT-FT		2893690000
W2T 4 DT-FT BL		2893700000
W2T 4 DT-FT BK		2893710000

Type	Qty.	Order No.
W2T 4 DT-FT STB		2893720000

Accessories

Plug-in cross-connection	2-pole 10-pole
Vertical jumpers	
End plate	1-pole
End bracket	dark beige blue Black
Screwdriver	dark beige
Holder for cartridge fuse 5 x 20 mm	Standard
Disconnect plug	400 V AC/DC, without LED 10 - 36 V AC/DC, red LED 35 - 70 V AC/DC, red LED 60 - 150 V AC/DC, red LED 140 - 250 V AC/DC, red LED
Module connector (max. 250 V)	orange without fittings With 1N4007 diode with wire jumper
Marking tags	
For detailed information on other accessories and application in the online catalogue	

Type	Qty.	Order No.
ZQV 4N/2	32 A 60	1527930000
ZQV 4N/10	32 A 20	1528090000
ZVQ 2.5/1.5	24 A 50	1720700000
WEP 2C 4		2894210000
WEP 2C 4 BL		2894220000
WEP 2C 4 BK		2894230000
WEW 35/2	50	1061200000
SDS 0.6X3.5X100	1	2749340000
SIHA 3/G20	6.3 A 25	7921560000
SIHA 3/G20/LD 10-36V	25	7921570000
SIHA 3/G20/LD 35-70V	25	7921580000
SIHA 3/G20/LD 60-150V	25	7921590000
SIHA 3/G20/LD 140-250V	25	7921600000
TNST OR	20 A 50	2463540000
BEST	50	1833100000
BEST/D	1 A 50	1878560000
BEST/DRBR	22 A 50	1878570000
WS 8/6 MM WS	600	2007160000
DEK 5/6 MM WS	600	2007120000
DEK 5/6 PLUS MC NE WS	1000	1011320000
DEK 5/5 MC NE WS	1000	1609801044

Type	Qty.	Order No.
ZQV 4N/2	32 A 60	1527930000
ZQV 4N/10	32 A 20	1528090000
ZVQ 2.5/1.5	24 A 50	1720700000
WEP 2C 4		2894210000
WEP 2C 4 BL		2894220000
WEP 2C 4 BK		2894230000
WEW 35/2	50	1061200000
SDS 0.6X3.5X100	1	2749340000
SIHA 3/G20	6.3 A 25	7921560000
SIHA 3/G20/LD 10-36V	25	7921570000
SIHA 3/G20/LD 35-70V	25	7921580000
SIHA 3/G20/LD 60-150V	25	7921590000
SIHA 3/G20/LD 140-250V	25	7921600000
TNST OR	20 A 50	2463540000
BEST	50	1833100000
BEST/D	1 A 50	1878560000
BEST/DRBR	22 A 50	1878570000
WS 8/6 MM WS	600	2007160000
DEK 5/6 MM WS	600	2007120000
DEK 5/6 PLUS MC NE WS	1000	1011320000
DEK 5/5 MC NE WS	1000	1609801044



W2T 4 DT-FT-PE

4 mm²

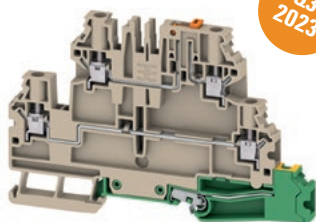

Q3
2023

W2T 4 DT-FT-PE STB

4 mm²

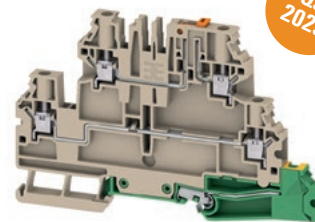

Q3
2023

Width/Height/Depth	mm
max. current / max. cond. cross-section	A/mm ²
Max. clamping range	mm ²

6.1 x 106.5 x 72.5
20 / 4
0.2...4

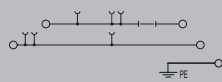

6.1 x 106.5 x 72.5
20 / 4
0.2...4

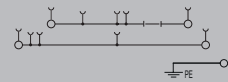

Technical data

Rated data	
Rated voltage	V
Rated current	A
for wire cross-section	mm ²
Rated impulse withstand voltage / Pollution severity	
Gauge to IEC 60947-1 / UL 94 flammability rating	
Approvals	
Clamped conductors (H05V/H07V)	
Solid / Stranded	mm ²
Flexible / Flexible with ferrule	mm ²
Twin wire-end ferrule	mm ²
Stripping length / Blade size	mm/-

IEC 60947-7-1			
IEC	UL	CSA	EN 60079-7
500			
32			
4			
	6 kV / 3		
	A3 / V-0		
Rated connection			
0.5...4 / 0.5...4			
0.5...4 / 0.5...4			
0.5...1.5			
8 / 0.6 x 3.5 mm			

IEC 60947-7-1			
IEC	UL	CSA	EN 60079-7
500			
32			
4			
	6 kV / 3		
	A3 / V-0		
Rated connection			
0.5...4 / 0.5...4			
0.5...4 / 0.5...4			
0.5...1.5			
8 / 0.6 x 3.5 mm			

Note

Ordering data

Version	dark beige Blue Black
Note	

Type	Qty.	Order No.
W2T 4 DT-FT-PE		2893730000

Type	Qty.	Order No.
W2T 4 DT-FT-PE STB		2893740000

Accessories

Plug-in cross-connection	
	2-pole
	10-pole
Vertical jumpers	
	1-pole
End plate	
	dark beige
	blue
	Black
End bracket	
	dark beige
Screwdriver	
	Standard
Holder for cartridge fuse 5 x 20 mm	
	400 V AC/DC, without LED
	10 - 36 V AC/DC, red LED
	35 - 70 V AC/DC, red LED
	60 - 150 V AC/DC, red LED
	140 - 250 V AC/DC, red LED
Disconnect plug	
	orange
Module connector (max. 250 V)	
	without fittings
	With 1N4007 diode
	with wire jumper
Marking tags	
	WS 8/6 MM WS
	DEK 5/6 MM WS
	DEK 5/6 PLUS MC NE WS
	DEK 5/5 MC NE WS
For detailed information on other accessories and application in the online catalogue	

Type	Qty.	Order No.
ZQV 4N/2	32 A 60	1527930000
ZQV 4N/10	32 A 20	1528090000
ZVQ 2.5/1.5	24 A 50	1720700000
WEP 2C 4		2894210000
WEP 2C 4 BL		2894220000
WEP 2C 4 BK		2894230000
WEW 35/2	50	1061200000
SDS 0.6X3.5X100	1	2749340000
SIHA 3/G20	6.3 A 25	7921560000
SIHA 3/G20/LD 10-36V	25	7921570000
SIHA 3/G20/LD 35-70V	25	7921580000
SIHA 3/G20/LD 60-150V	25	7921590000
SIHA 3/G20/LD 140-250V	25	7921600000
TNST OR	20 A 50	2463540000
BEST	50	1833100000
BEST/D	1 A 50	1878560000
BEST/DRBR	22 A 50	1878570000
WS 8/6 MM WS	600	2007160000
DEK 5/6 MM WS	600	2007120000
DEK 5/6 PLUS MC NE WS	1000	1011320000
DEK 5/5 MC NE WS	1000	1609801044

Type	Qty.	Order No.
ZQV 4N/2	32 A 60	1527930000
ZQV 4N/10	32 A 20	1528090000
ZVQ 2.5/1.5	24 A 50	1720700000
WEP 2C 4		2894210000
WEP 2C 4 BL		2894220000
WEP 2C 4 BK		2894230000
WEW 35/2	50	1061200000
SDS 0.6X3.5X100	1	2749340000
SIHA 3/G20	6.3 A 25	7921560000
SIHA 3/G20/LD 10-36V	25	7921570000
SIHA 3/G20/LD 35-70V	25	7921580000
SIHA 3/G20/LD 60-150V	25	7921590000
SIHA 3/G20/LD 140-250V	25	7921600000
TNST OR	20 A 50	2463540000
BEST	50	1833100000
BEST/D	1 A 50	1878560000
BEST/DRBR	22 A 50	1878570000
WS 8/6 MM WS	600	2007160000
DEK 5/6 MM WS	600	2007120000
DEK 5/6 PLUS MC NE WS	1000	1011320000
DEK 5/5 MC NE WS	1000	1609801044

W2T 4 FS-FT DB

4 mm²

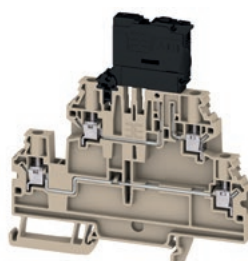

Q3
2023

W2T 4 FS-FT BL

4 mm²

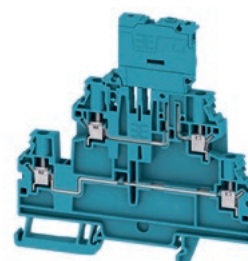

Q3
2023

Width/Height/Depth	mm
max. current / max. cond. cross-section	A/mm ²
Max. clamping range	mm ²

6.1 x 95.5 x 99.5
6.3 / 4
0.2...4

6.1 x 95.5 x 99.5
6.3 / 4
0.2...4

Technical data

Rated data	
Rated voltage	V
Rated current	A
for wire cross-section	mm ²
Rated impulse withstand voltage / Pollution severity	
Gauge to IEC 60947-1 / UL 94 flammability rating	
Approvals	
Clamped conductors (H05V/H07V)	
Solid / Stranded	mm ²
Flexible / Flexible with ferrule	mm ²
Twin wire-end ferrule	mm ²
Stripping length / Blade size	mm/-

IEC 60947-7-3			
IEC	UL	CSA	EN 60079-7
250			
6.3			
4			
	6 kV / 3		
	A3 / V-0		
Rated connection			
0.5...4 / 0.5...4			
0.5...4 / 0.5...4			
0.5...1.5			
8 / 0.6 x 3.5 mm			

IEC 60947-7-3			
IEC	UL	CSA	EN 60079-7
250			
6.3			
4			
	6 kV / 3		
	A3 / V-0		
Rated connection			
0.5...4 / 0.5...4			
0.5...4 / 0.5...4			
0.5...1.5			
8 / 0.6 x 3.5 mm			

Note

Ordering data

Version	500 V AC/DC, without LED 10-36 V AC/DC, with LED 30-70 V AC/DC, with LED 60-150 V AC/DC, with LED 100 - 250 V AC/DC, with LED
Note	

Type	Qty.	Order No.
W2T 4 FS-FT DB		2893850000
W2T 4 FS-FT 10-36V DB		2893880000
W2T 4 FS-FT 30-70V DB		2893910000
W2T 4 FS-FT 60-150V DB		2893940000
W2T 4 FS-FT 100-250V DB		2893970000

Type	Qty.	Order No.
W2T 4 FS-FT BL		2893860000
W2T 4 FS-FT 10-36V BL		2893890000
W2T 4 FS-FT 30-70V BL		2893920000
W2T 4 FS-FT 60-150V BL		2893950000
W2T 4 FS-FT 100-250V BL		2893980000

Accessories

Plug-in cross-connection	2-pole 10-pole
End plate	dark beige blue Black
End bracket	dark beige
Screwdriver	Standard
G-fuse cartridge, 5 x 20 mm (IEC 60127-2)	0.25 A fast 0.50 A fast 1.00 A fast 2.00 A fast
Marking tags	

Type	Qty.	Order No.
ZQV 4N/2	32 A 60	1527930000
ZQV 4N/10	32 A 20	1528090000
WEP 2C 4		2894210000
WEP 2C 4 BL		2894220000
WEP 2C 4 BK		2894230000
WEW 35/2	50	1061200000
SDS 0.6X3.5X100	1	2749340000
G 20/0.25A/F	0.25 A 10	0430500000
G 20/0.50A/F	0.5 A 10	0430600000
G 20/1.00A/F	1 A 10	0430700000
G 20/2.00A/F	2 A 10	0430900000
WS 8/6 MM WS	600	2007160000
DEK 5/6 MM WS	600	2007120000
DEK 5/6 PLUS MC NE WS	1000	1011320000
DEK 5/5 MC NE WS	1000	1609801044

Type	Qty.	Order No.
ZQV 4N/2	32 A 60	1527930000
ZQV 4N/10	32 A 20	1528090000
WEP 2C 4		2894210000
WEP 2C 4 BL		2894220000
WEP 2C 4 BK		2894230000
WEW 35/2	50	1061200000
SDS 0.6X3.5X100	1	2749340000
G 20/0.25A/F	0.25 A 10	0430500000
G 20/0.50A/F	0.5 A 10	0430600000
G 20/1.00A/F	1 A 10	0430700000
G 20/2.00A/F	2 A 10	0430900000
WS 8/6 MM WS	600	2007160000
DEK 5/6 MM WS	600	2007120000
DEK 5/6 PLUS MC NE WS	1000	1011320000
DEK 5/5 MC NE WS	1000	1609801044

For detailed information on other accessories and application in the online catalogue

W2T 4 FS-FT BK

4 mm²

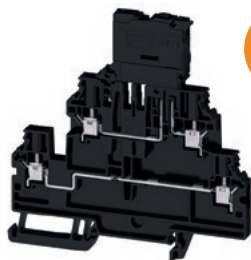

Q3
2023

W2T 4 FS-FT BK STB

4 mm²

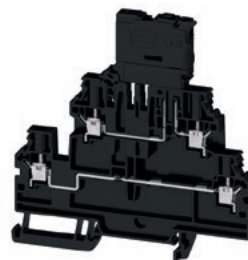

Q3
2023

Width/Height/Depth	mm
max. current / max. cond. cross-section	A/mm ²
Max. clamping range	mm ²

6.1 x 95.5 x 99.5
6.3 / 4
0.2...4

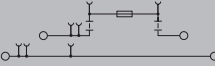

6.1 x 95.5 x 99.5
6.3 / 4
0.2...4

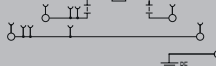

Technical data

Rated data	
Rated voltage	V
Rated current	A
for wire cross-section	mm ²
Rated impulse withstand voltage / Pollution severity	
Gauge to IEC 60947-1 / UL 94 flammability rating	
Approvals	

IEC 60947-7-3			
IEC	UL	CSA	EN 60079-7
250			
6.3			
4			
	6 kV / 3		
	A3 / V-0		

IEC 60947-7-3			
IEC	UL	CSA	EN 60079-7
250			
6.3			
4			
	6 kV / 3		
	A3 / V-0		

Clamped conductors (H05V/H07V)	
Solid / Stranded	mm ²
Flexible / Flexible with ferrule	mm ²
Twin wire-end ferrule	mm ²
Stripping length / Blade size	mm/-

Rated connection	
0.5...4 / 0.5...4	
0.5...4 / 0.5...4	
0.5...1.5	
8 / 0.6 x 3.5 mm	

Rated connection	
0.5...4 / 0.5...4	
0.5...4 / 0.5...4	
0.5...1.5	
8 / 0.6 x 3.5 mm	

Note

Ordering data

Version	
500 V AC/DC, without LED	
10-36 V AC/DC, with LED	
30-70 V AC/DC, with LED	
60-150 V AC/DC, with LED	
100 - 250 V AC/DC, with LED	

Type	Qty.	Order No.
W2T 4 FS-FT BK		2893870000
W2T 4 FS-FT 10-36V BK		2893900000
W2T 4 FS-FT 30-70V BK		2893930000
W2T 4 FS-FT 60-150V BK		2893960000
W2T 4 FS-FT 100-250V BK		2893990000

Type	Qty.	Order No.
W2T 4 FS-FT BK STB		2894000000
W2T 4 FS-FT 10-36V BK STB		2894010000
W2T 4 FS-FT 30-70V BK STB		2894020000
W2T 4 FS-FT 60-150V BK STB		2894030000
W2T 4 FS-FT 100-250V BK STB		2894040000

Note

Accessories

Plug-in cross-connection	
2-pole	
10-pole	

Type	Qty.	Order No.
ZQV 4N/2	32 A 60	1527930000
ZQV 4N/10	32 A 20	1528090000

Type	Qty.	Order No.
ZQV 4N/2	32 A 60	1527930000
ZQV 4N/10	32 A 20	1528090000

End plate	
dark beige	
blue	
Black	

WEP 2C 4		2894210000
WEP 2C 4 BL		2894220000
WEP 2C 4 BK		2894230000

WEP 2C 4		2894210000
WEP 2C 4 BL		2894220000
WEP 2C 4 BK		2894230000

End bracket	
dark beige	

WEW 35/2	50	1061200000
----------	----	------------

WEW 35/2	50	1061200000
----------	----	------------

Screwdriver	
Standard	

SDS 0.6X3.5X100	1	2749340000
-----------------	---	------------

SDS 0.6X3.5X100	1	2749340000
-----------------	---	------------

G-fuse cartridge, 5 x 20 mm (IEC 60127-2)	
0.25 A fast	
0.50 A fast	
1.00 A fast	
2.00 A fast	

G 20/0.25A/F	0.25 A	10	0430500000
G 20/0.50A/F	0.5 A	10	0430600000
G 20/1.00A/F	1 A	10	0430700000
G 20/2.00A/F	2 A	10	0430900000

G 20/0.25A/F	0.25 A	10	0430500000
G 20/0.50A/F	0.5 A	10	0430600000
G 20/1.00A/F	1 A	10	0430700000
G 20/2.00A/F	2 A	10	0430900000

Marking tags		
WS 8/6 MM WS	600	2007160000
DEK 5/6 MM WS	600	2007120000
DEK 5/6 PLUS MC NE WS	1000	1011320000
DEK 5/5 MC NE WS	1000	1609801044

WS 8/6 MM WS	600	2007160000
DEK 5/6 MM WS	600	2007120000
DEK 5/6 PLUS MC NE WS	1000	1011320000
DEK 5/5 MC NE WS	1000	1609801044

WS 8/6 MM WS	600	2007160000
DEK 5/6 MM WS	600	2007120000
DEK 5/6 PLUS MC NE WS	1000	1011320000
DEK 5/5 MC NE WS	1000	1609801044

For detailed information on other accessories and application in the online catalogue

For detailed information on other accessories and application in the online catalogue

W2T 4 FS-FT-PE BK

4 mm²

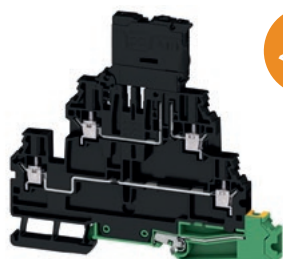

Q3
2023

6.1 x 106.5 x 99.5
6.3 / 4
0.2...4

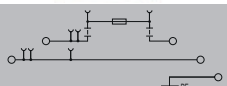

IEC 60947-7-3

IEC	UL	CSA	EN 60079-7
250			
6.3			
4			
6 kV / 3			
A3 / V-0			

Rated connection

0.5...4 / 0.5...4
0.5...4 / 0.5...4
0.5...1.5
8 / 0.6 x 3.5 mm

W2T 4 FS-FT-PE BK STB

4 mm²

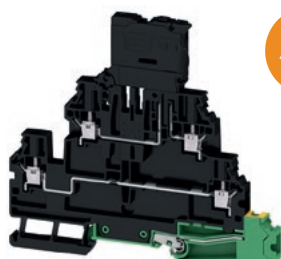

Q3
2023

6.1 x 106.5 x 99.5
6.3 / 4
0.2...4

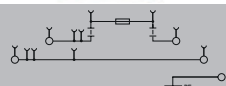

IEC 60947-7-3

IEC	UL	CSA	EN 60079-7
250			
6.3			
4			
6 kV / 3			
A3 / V-0			

Rated connection

0.5...4 / 0.5...4
0.5...4 / 0.5...4
0.5...1.5
8 / 0.6 x 3.5 mm

Type	Qty.	Order No.
W2T 4 FS-FT-PE BK		2894050000
W2T 4 FS-FT-PE 10-36V BK		2894060000
W2T 4 FS-FT-PE 30-70V BK		2894070000
W2T 4 FS-FT-PE 60-150V BK		2894080000
W2T 4 FS-FT-PE 100-250V BK		2894090000

Type	Qty.	Order No.
W2T 4 FS-FT-PE BK STB		2894100000
W2T 4 FS-FT-PE 10-36V BK STB		2894110000
W2T 4 FS-FT-PE 30-70V BK STB		2894120000
W2T 4 FS-FT-PE 60-150V BK STB		2894130000
W2T 4 FS-FT-PE 100-250V BK STB		2894140000

Type	Qty.	Order No.
ZQV 4N/2	32 A 60	1527930000
ZQV 4N/10	32 A 20	1528090000
WEP 2C 4		2894210000
WEP 2C 4 BL		2894220000
WEP 2C 4 BK		2894230000
WEW 35/2	50	1061200000
SDS 0.6X3.5X100	1	2749340000
G 20/0.25A/F	0.25 A 10	0430500000
G 20/0.50A/F	0.5 A 10	0430600000
G 20/1.00A/F	1 A 10	0430700000
G 20/2.00A/F	2 A 10	0430900000
WS 8/6 MM WS	600	2007160000
DEK 5/6 MM WS	600	2007120000
DEK 5/6 PLUS MC NE WS	1000	1011320000
DEK 5/5 MC NE WS	1000	1609801044

Type	Qty.	Order No.
ZQV 4N/2	32 A 60	1527930000
ZQV 4N/10	32 A 20	1528090000
WEP 2C 4		2894210000
WEP 2C 4 BL		2894220000
WEP 2C 4 BK		2894230000
WEW 35/2	50	1061200000
SDS 0.6X3.5X100	1	2749340000
G 20/0.25A/F	0.25 A 10	0430500000
G 20/0.50A/F	0.5 A 10	0430600000
G 20/1.00A/F	1 A 10	0430700000
G 20/2.00A/F	2 A 10	0430900000
WS 8/6 MM WS	600	2007160000
DEK 5/6 MM WS	600	2007120000
DEK 5/6 PLUS MC NE WS	1000	1011320000
DEK 5/5 MC NE WS	1000	1609801044



Width/Height/Depth	mm
max. current / max. cond. cross-section	A/mm ²
Max. clamping range	mm ²

Technical data

Rated data	
Rated voltage	-
Rated current	A
for wire cross-section	mm ²
Rated impulse withstand voltage / Pollution severity	
Gauge to IEC 60947-1 / UL 94 flammability rating	
Approvals	
Clamped conductors (H05V/H07V)	
Solid / Stranded	mm ²
Flexible / Flexible with ferrule	mm ²
Twin wire-end ferrule	-
Stripping length / Blade size	mm/-

Note

Ordering data

Version	
	black for TS 35x15
	blue for TS 35x15
	black for TS 35x7.5
	blue for TS 35x7.5

Note

Accessories

End plate	
	black
	blue
	grey
Marker holder	
	black for TS 35x15
	blue for TS 35x15
	black for TS 35x7.5
	blue for TS 35x7.5
Spacer	
	Unprinted
	Printed 0...3 or 0...7 or 0...15
	Printed 1...4 or 1...8 or 1...16
	Printed A...D or A...H or A...P
End bracket	
	black
Screwdriver	
	Standard
Plug-in cross-connection	
	2-pole
Marking tags	

For detailed information on other accessories and application in the online catalogue

PRV 4 RT

1.5 mm²



9.2 x 70 x 54.5	
13 / 1.5	
0.13...1.5	

IEC	UL	CSA	EN 60079-7
250	300	300	
10	10	10	
1.5	16	AWG 26...16	
4 kV / 3			
/ V-0			

CE		
Rated connection		
0.5...1.5 / 0.5...1.5		
0.5...1.5 / 0.5...1.5		
10 / 0.6 x 3.5 mm		

Type	Qty.	Order No.
PRV 4 SW 35X15 RT	20	1173810000
PRV 4 BL 35X15 RT	20	1267890000
PRV 4 SW 35X7.5 RT	20	1173830000
PRV 4 BL 35X7.5 RT	20	1267900000

Type	Qty.	Order No.
PAP PRV/PPV4 SW	10	1173750000
PAP PRV/PPV4 BL	10	1268010000
PAP PRV/PPV4 GR	10	1211450000

Type	Qty.	Order No.
BZT PRV4 SW 35X15	20	1173590000
BZT PRV4 BL 35X15	20	1267980000
BZT PRV4 SW 35X7.5	20	1173600000
BZT PRV4 BL 35X7.5	20	1267990000

Type	Qty.	Order No.
TW PRV4	10	1173700000
TW PRV4 0-3	10	1230060000
TW PRV4 1-4	10	1230050000
TW PRV4 A-D	10	1230070000

Type	Qty.	Order No.
ZEW 35/2 SW	20	1162610000

Type	Qty.	Order No.
SDIS SLIM 0.6X3.5X100	1	2749610000

Type	Qty.	Order No.
SRC-I QV P	10	8870840000

Type	Qty.	Order No.
WS 7.8/9.2 PLUS MC NE GR	360	1208970000

PRV 4 WS

1.5 mm²



9.2 x 70 x 54.5	
13 / 1.5	
0.13...1.5	

IEC 60947-7-1, DIN EN 60079

IEC	UL	CSA	EN 60079-7
250	300	300	
10	10	10	
1.5	16	AWG 26...16	
4 kV / 3			
/ V-0			

CE		
Rated connection		
0.5...1.5 / 0.5...1.5		
0.5...1.5 / 0.5...1.5		
10 / 0.6 x 3.5 mm		

Type	Qty.	Order No.
PRV 4 SW 35X15 WS	20	1173820000
PRV 4 BL 35X15 WS	20	1173920000
PRV 4 SW 35X7.5 WS	20	1173840000
PRV 4 BL 35X7.5 WS	20	1173930000

Type	Qty.	Order No.
PAP PRV/PPV4 SW	10	1173750000
PAP PRV/PPV4 BL	10	1268010000
PAP PRV/PPV4 GR	10	1211450000

Type	Qty.	Order No.
BZT PRV4 SW 35X15	20	1173590000
BZT PRV4 BL 35X15	20	1267980000
BZT PRV4 SW 35X7.5	20	1173600000
BZT PRV4 BL 35X7.5	20	1267990000

Type	Qty.	Order No.
TW PRV4	10	1173700000
TW PRV4 0-3	10	1230060000
TW PRV4 1-4	10	1230050000
TW PRV4 A-D	10	1230070000

Type	Qty.	Order No.
ZEW 35/2 SW	20	1162610000

Type	Qty.	Order No.
SDIS SLIM 0.6X3.5X100	1	2749610000

Type	Qty.	Order No.
SRC-I QV P	10	8870840000

Type	Qty.	Order No.
WS 7.8/9.2 PLUS MC NE GR	360	1208970000

For detailed information on other accessories and application in the online catalogue



PRV 8 RT/WS

1.5 mm²

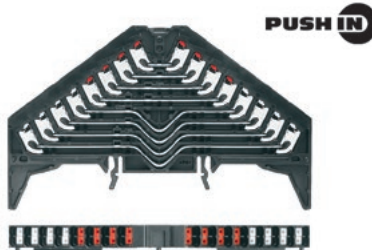

PRV 8 WS/RT

1.5 mm²

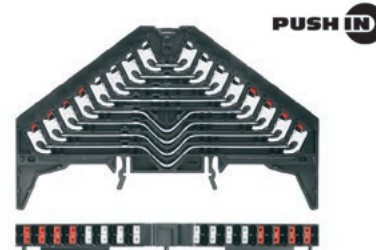

Width/Height/Depth	mm
max. current / max. cond. cross-section	A/mm ²
Max. clamping range	mm ²

9.2 x 120 x 73	
10 / 1.5	
0.13...1.5	

9.2 x 120 x 73	
10 / 1.5	
0.13...1.5	

Technical data

Rated data	
Rated voltage	-
Rated current	A
for wire cross-section	mm ²
Rated impulse withstand voltage / Pollution severity	
Gauge to IEC 60947-1 / UL 94 flammability rating	
Approvals	
Clamped conductors (H05V/H07V)	
Solid / Stranded	mm ²
Flexible / Flexible with ferrule	mm ²
Twin wire-end ferrule	-
Stripping length / Blade size	mm/-

IEC	UL	CSA	EN 60079-7
250	300	300	
8	10	10	
1.5	16	AWG 26...16	
4 kV / 3			
/ V-0			
CE			
Rated connection			
0.5...1.5 / 0.5...1.5			
0.5...1.5 / 0.5...1.5			
10 / 0.6 x 3.5 mm			

IEC 60947-1

IEC	UL	CSA	EN 60079-7
250	300	300	
8	10	10	
1.5	16	AWG 26...16	
4 kV / 3			
/ V-0			
CE			
Rated connection			
0.5...1.5 / 0.5...1.5			
0.5...1.5 / 0.5...1.5			
10 / 0.6 x 3.5 mm			

Note

Ordering data

Version	
	black for TS 35x15
	blue for TS 35x15
	black for TS 35x7.5
	blue for TS 35x7.5

Note

Type	Qty.	Order No.
PRV 8 SW 35X15 RT/WS	20	1173740000
PRV 8 BL 35X15 RT/WS	20	1267830000
PRV 8 SW 35X7.5 RT/WS	20	1173790000
PRV 8 BL 35X7.5 RT/WS	20	1267840000

Type	Qty.	Order No.
PRV 8 SW 35X15 WS/RT	20	1173780000
PRV 8 BL 35X15 WS/RT	20	1173900000
PRV 8 SW 35X7.5 WS/RT	20	1173800000
PRV 8 BL 35X7.5 WS/RT	20	1173910000

Accessories

End plate	
	black
	blue
	grey
Marker holder	
	black for TS 35x15
	blue for TS 35x15
	black for TS 35x7.5
	blue for TS 35x7.5
Spacer	
	Unprinted
	Printed 0...3 or 0...7 or 0...15
	Printed 1...4 or 1...8 or 1...16
	Printed A...D or A...H or A...P
End bracket	
	black
Screwdriver	
	Standard
Plug-in cross-connection	
	2-pole
Marking tags	

Type	Qty.	Order No.
PAP PRV/PPV8 SW	10	1173720000
PAP PRV/PPV8 BL	10	1268000000
PAP PRV/PPV8 GR	10	1211460000
BZT PRV8 SW 35X15	20	1173570000
BZT PRV8 BL 35X15	20	1267950000
BZT PRV8 SW 35X7.5	20	1173580000
BZT PRV8 BL 35X7.5	20	1267970000
TW PRV8	10	1173670000
TW PRV8 0-7	10	1230090000
TW PRV8 1-8	10	1230080000
TW PRV8 A-H	10	1230110000
ZEW 35/2 SW	20	1162610000
SDIS SLIM 0.6X3.5X100	1	2749610000
SRC-I QV P	10	8870840000
WS 7.8/9.2 PLUS MC NE GR	360	1208970000

Type	Qty.	Order No.
PAP PRV/PPV8 SW	10	1173720000
PAP PRV/PPV8 BL	10	1268000000
PAP PRV/PPV8 GR	10	1211460000
BZT PRV8 SW 35X15	20	1173570000
BZT PRV8 BL 35X15	20	1267950000
BZT PRV8 SW 35X7.5	20	1173580000
BZT PRV8 BL 35X7.5	20	1267970000
TW PRV8	10	1173670000
TW PRV8 0-7	10	1230090000
TW PRV8 1-8	10	1230080000
TW PRV8 A-H	10	1230110000
ZEW 35/2 SW	20	1162610000
SDIS SLIM 0.6X3.5X100	1	2749610000
SRC-I QV P	10	8870840000
WS 7.8/9.2 PLUS MC NE GR	360	1208970000

For detailed information on other accessories and application in the online catalogue





Width/Height/Depth	mm
max. current / max. cond. cross-section	A/mm ²
Max. clamping range	mm ²

Technical data

Rated data	
Rated voltage	-
Rated current	A
for wire cross-section	mm ²
Rated impulse withstand voltage / Pollution severity	
Gauge to IEC 60947-1 / UL 94 flammability rating	
Approvals	
Clamped conductors (H05V/H07V)	
Solid / Stranded	mm ²
Flexible / Flexible with ferrule	mm ²
Twin wire-end ferrule	-
Stripping length / Blade size	mm/-

Note

Ordering data

Version	black for TS 35x15 blue for TS 35x15 black for TS 35x7.5 blue for TS 35x7.5
---------	--

Note

Accessories

End plate	black blue grey
Marker holder	black for TS 35x15 blue for TS 35x15 black for TS 35x7.5 blue for TS 35x7.5
Spacer	Unprinted Printed 0...3 or 0...7 or 0...15 Printed 1...4 or 1...8 or 1...16 Printed A...D or A...H or A...P
End bracket	black
Screwdriver	Standard
Plug-in cross-connection	2-pole
Marking tags	

For detailed information on other accessories and application in the online catalogue

PRV 16 RT/WS

1.5 mm²

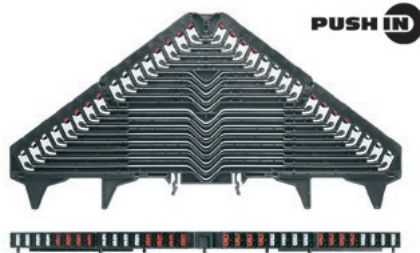

9.2 x 225 x 113.5	
11 / 1.5	
0.13...1.5	

IEC 60947-7-1, DIN EN 60079

IEC	UL	CSA	EN 60079-7
250	300	300	
6	1	1	
1.5	16	AWG 26...16	
4 kV / 3			
/ V-0			

CE e-PA EN

Rated connection	
0.5...1.5 / 0.5...1.5	
0.5...1.5 / 0.5...1.5	
10 / 0.6 x 3.5 mm	

Type	Qty.	Order No.
PRV 16 SW 35X15 RT/WS	20	1173620000
PRV 16 BL 35X15 RT/WS	20	1267790000
PRV 16 SW 35X7.5 RT/WS	20	1173680000
PRV 16 BL 35X7.5 RT/WS	20	1267810000

Type	Qty.	Order No.
BZT PRV16 SW 35X15	20	1173540000
BZT PRV16 BL 35X15	20	1267930000
BZT PRV16 SW 35X7.5	20	1173550000
BZT PRV16 BL 35X7.5	20	1267940000
TW PRV16	10	1173630000
TW PRV16 0-15	10	1230130000
TW PRV16 1-16	10	1230120000
TW PRV16 A-P	10	1230140000
WEW 35/1 SW	50	1162600000
SDIS SLIM 0.6X3.5X100	1	2749610000
SRC-I QV P	10	8870840000
WS 7.8/9.2 PLUS MC NE GR	360	1208970000

PRV 16 WS/RT

1.5 mm²

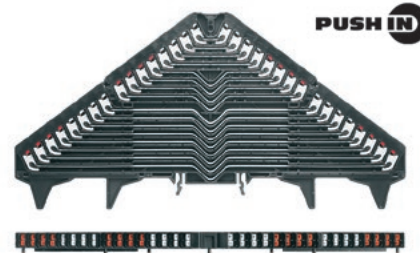

9.2 x 225 x 113.5	
11 / 1.5	
0.13...1.5	

IEC 60947-7-1, DIN EN 60079

IEC	UL	CSA	EN 60079-7
250	300	300	
6	1	1	
1.5	16	AWG 26...16	
4 kV / 3			
/ V-0			

CE e-PA EN

Rated connection	
0.5...1.5 / 0.5...1.5	
0.5...1.5 / 0.5...1.5	
10 / 0.6 x 3.5 mm	

Type	Qty.	Order No.
PRV 16 SW 35X15 WS/RT	20	1173650000
PRV 16 BL 35X15 WS/RT	20	1267800000
PRV 16 SW 35X7.5 WS/RT	20	1173710000
PRV 16 BL 35X7.5 WS/RT	20	1267820000

Type	Qty.	Order No.
BZT PRV16 SW 35X15	20	1173540000
BZT PRV16 BL 35X15	20	1267930000
BZT PRV16 SW 35X7.5	20	1173550000
BZT PRV16 BL 35X7.5	20	1267940000
TW PRV16	10	1173630000
TW PRV16 0-15	10	1230130000
TW PRV16 1-16	10	1230120000
TW PRV16 A-P	10	1230140000
WEW 35/1 SW	50	1162600000
SDIS SLIM 0.6X3.5X100	1	2749610000
SRC-I QV P	10	8870840000
WS 7.8/9.2 PLUS MC NE GR	360	1208970000



PPV 4

1.5 mm²

PPV 8

1.5 mm²

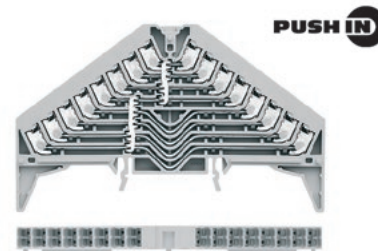
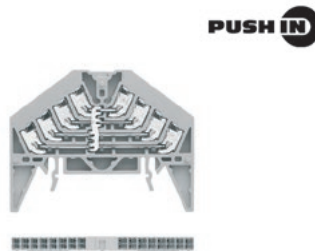

Width/Height/Depth	mm
max. current / max. cond. cross-section	-/mm ²
Max. clamping range	mm ²

9.2 x 70 x 54.5	
/ 1.5	
0.13...1.5	

9.2 x 120 x 73	
/ 1.5	
0.13...1.5	

Technical data

Rated data	
Rated voltage	-
Rated current	A
for wire cross-section	mm ²
Rated impulse withstand voltage / Pollution severity	
Gauge to IEC 60947-1 / UL 94 flammability rating	
Approvals	
Clamped conductors (H05V/H07V)	
Solid / Stranded	mm ²
Flexible / Flexible with ferrule	mm ²
Twin wire-end ferrule	-
Stripping length / Blade size	mm/-

IEC 60947-7-1, DIN EN 60079

IEC	UL	CSA	EN 60079-7
250	300	300	
17.5	10	10	
1.5	AWG 26...16	AWG 26...16	
4 kV / 3			
/ V-0			

IEC 60947-7-1

IEC	UL	CSA	EN 60079-7
250	300	300	
17.5	10	10	
1.5	AWG 26...16	AWG 26...16	
4 kV / 3			
/ V-0			

CE

Rated connection	
0.5...1.5 / 0.5...1.5	
0.5...1.5 / 0.5...1.5	
10 / 0.6 x 3.5 mm	

CE

Rated connection	
0.5...1.5 / 0.5...1.5	
0.5...1.5 / 0.5...1.5	
10 / 0.6 x 3.5 mm	

Note

Ordering data

Version	
	blue for TS 35x15
	grey for TS 35x15
	orange for TS 35x15
	blue for TS 35x7.5
	grey for TS 35x7.5
	orange for TS 35x7.5

Type	Qty.	Order No.
PPV 4 BL 35X15 DGR	20	1267910000
PPV 4 GR 35X15 DGR	20	1173880000
PPV 4 OR 35X15 DGR	20	1301610000
PPV 4 BL 35X7.5 DGR	20	1267920000
PPV 4 GR 35X7.5 DGR	20	1173890000
PPV 4 OR 35X7.5 DGR	20	1301630000

Type	Qty.	Order No.
PPV 8 BL 35X15 DGR	20	1267870000
PPV 8 GR 35X15 DGR	20	1173850000
PPV 8 OR 35X15 DGR	20	1301620000
PPV 8 BL 35X7.5 DGR	20	1267880000
PPV 8 GR 35X7.5 DGR	20	1173870000
PPV 8 OR 35X7.5 DGR	20	1301640000

Note

Accessories

End plate	
	black
	blue
	grey
Marker holder	
	black for TS 35x15
	blue for TS 35x15
	black for TS 35x7.5
	blue for TS 35x7.5
Spacer	
	Unprinted
	Printed 0...3 or 0...7 or 0...15
	Printed 1...4 or 1...8 or 1...16
	Printed A...D or A...H or A...P
End bracket	
	black
Screwdriver	
	Standard
Plug-in cross-connection	
	2-pole
Marking tags	

Type	Qty.	Order No.
PAP PRV/PPV4 SW	10	1173750000
PAP PRV/PPV4 BL	10	1268010000
PAP PRV/PPV4 GR	10	1211450000
BZT PRV4 SW 35X15	20	1173590000
BZT PRV4 BL 35X15	20	1267980000
BZT PRV4 SW 35X7.5	20	1173600000
BZT PRV4 BL 35X7.5	20	1267990000
TW PRV4	10	1173700000
TW PRV4 0-3	10	1230060000
TW PRV4 1-4	10	1230050000
TW PRV4 A-D	10	1230070000
ZEW 35/2 SW	20	1162610000
SDIS SLIM 0.6X3.5X100	1	2749610000
SRC-I QV P	10	8870840000
WS 7.8/9.2 PLUS MC NE GR	360	1208970000

Type	Qty.	Order No.
PAP PRV/PPV8 SW	10	1173720000
PAP PRV/PPV8 BL	10	1268000000
PAP PRV/PPV8 GR	10	1211460000
BZT PRV8 SW 35X15	20	1173570000
BZT PRV8 BL 35X15	20	1267950000
BZT PRV8 SW 35X7.5	20	1173580000
BZT PRV8 BL 35X7.5	20	1267970000
TW PRV8	10	1173670000
TW PRV8 0-7	10	1230090000
TW PRV8 1-8	10	1230080000
TW PRV8 A-H	10	1230110000
ZEW 35/2 SW	20	1162610000
SDIS SLIM 0.6X3.5X100	1	2749610000
SRC-I QV P	10	8870840000
WS 7.8/9.2 PLUS MC NE GR	360	1208970000

For detailed information on other accessories and application in the online catalogue



Signal marshalling
Screw connection



Width/Height/Depth	mm
max. current / max. cond. cross-section	A
Max. clamping range	mm ²

Technical data

Rated data	
Rated voltage	V
Rated current	A
for wire cross-section	mm ²
Rated impulse withstand voltage / Pollution severity	
Gauge to IEC 60947-1 / UL 94 flammability rating	
Approvals	
Clamped conductors (H05V/H07V)	
Solid / Stranded	mm ²
Flexible / Flexible with ferrule	mm ²
Tightening torque / Clamping screw	Nm
Stripping length / Blade size	mm/-

Note

Ordering data

Version	dark beige
	Blue
Note	

Accessories

Plug-in cross-connection	2-pole
	10-pole
End plate / Partition plate	dark beige
End bracket	dark beige, screwable
	dark beige
Screwdriver	Standard
Holder for cartridge fuse 5 x 20 mm	400 V AC/DC, without LED
	10 - 36 V AC/DC, red LED
	140 - 250 V AC/DC, red LED
Module connector (max. 250 V)	without fittings
	with wire jumper
	With 1N4007 diode
Disconnect plug	removable, as replacement for release lever
Marking tags	

For detailed information on other accessories and application in the online catalogue

WMF 2.5

2.5 mm²

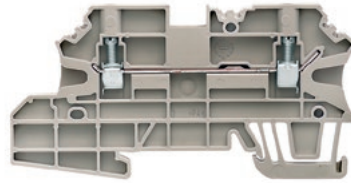

5.08 x 88 x 44.5
32 / 4
0.5...4



Ex ec II C GcII
3 G D

IEC	UL	CSA	EN 60079-7
800	600	600	500
24	20	26	23
2.5	AWG 26...12	AWG 26...12	2.5 mm ²
8 kV / 3			
A3 / V-0			

Rated connection			
0.5...4 / 1.5...4			
0.5...4 / 0.5...2.5			
0.5...0.6 / (M 3)			
10 / 0.6 x 3.5 mm			

Type	Qty.	Order No.
WMF 2.5	50	1143070000
WMF 2.5 BL	50	1270040000

Type	Qty.	Order No.
ZQV 2.5N/2	24 A 60	1527540000
ZQV 2.5N/10	24 A 20	1527690000
AP WMF2.5	50	1142990000
WEW 35/2	50	1061200000
SDS 0.6X3.5X100	1	2749340000
SIHA 3/G20	6.3 A 25	7921560000
SIHA 3/G20/LD 10-36V	25	7921570000
SIHA 3/G20/LD 140-250V	25	7921600000
FUCR SW	10	1167630000
FUCR 10-36V SW	10	1167640000
FUCR 100-250V SW	10	1167680000
BEST/DRBR	22 A 50	1878570000
BEST/D	1 A 50	1878560000
DEK 5/5 MC NE WS	1000	1609801044
WS 10/5 M MC NE WS	720	1792000000

For detailed information on other accessories and application in the online catalogue

WMF 2.5 DI

2.5 mm²

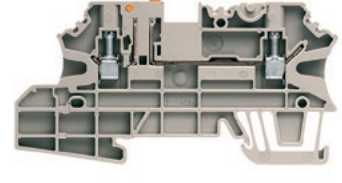

5.08 x 88 x 44.5
20 / 4
0.5...4

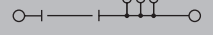

Ex ec II C GcII
3 G D

IEC	UL	CSA	EN 60079-7
500	600	300	500
20	19	19	18.5
2.5	AWG 26...12	AWG 26...12	2.5 mm ²
8 kV / 3			
A3 / V-0			

Rated connection			
0.5...4 / 1.5...4			
0.5...4 / 0.5...2.5			
0.5...0.6 / (M 3)			
10 / 0.6 x 3.5 mm			

Type	Qty.	Order No.
WMF 2.5 DI	50	1143020000
WMF 2.5 DI BL	50	1270070000

Type	Qty.	Order No.
ZQV 2.5N/2	24 A 60	1527540000
ZQV 2.5N/10	24 A 20	1527690000
AP WMF2.5	50	1142990000
WEW 35/2	50	1061200000
SDS 0.6X3.5X100	1	2749340000
SIHA 3/G20	6.3 A 25	7921560000
SIHA 3/G20/LD 10-36V	25	7921570000
SIHA 3/G20/LD 140-250V	25	7921600000
FUCR SW	10	1167630000
FUCR 10-36V SW	10	1167640000
FUCR 100-250V SW	10	1167680000
BEST/DRBR	22 A 50	1878570000
BEST/D	1 A 50	1878560000
DEK 5/5 MC NE WS	1000	1609801044
WS 10/5 M MC NE WS	720	1792000000

For detailed information on other accessories and application in the online catalogue

WMF 2.5 DI PE

2.5 mm²

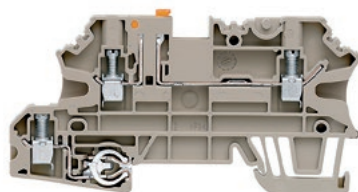

Width/Height/Depth	mm
max. current / max. cond. cross-section	A
Max. clamping range	mm ²

5.08 x 88 x 44.5
20 / 4
0.5...4

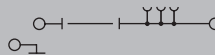

Ex ec II C GcII
3 G D

Technical data

Rated data	
Rated voltage	V
Rated current	A
for wire cross-section	mm ²
Rated impulse withstand voltage / Pollution severity	
Gauge to IEC 60947-1 / UL 94 flammability rating	
Approvals	
Clamped conductors (H05V/H07V)	
Solid / Stranded	mm ²
Flexible / Flexible with ferrule	mm ²
Tightening torque / Clamping screw	Nm
Stripping length / Blade size	mm/-

IEC	UL	CSA	EN 60079-7
500	600	600	500
20	19	19	18.5
2.5	AWG 26...12	AWG 26...12	2.5 mm ²
8 kV / 3			
A3 / V-0			

Rated connection	
0.5...4 / 1.5...4	
0.5...4 / 0.5...2.5	
0.5...0.6 / (M 3)	
10 / 0.6 x 3.5 mm	

Note

Ordering data

Version	dark beige
	Blue
Note	

Type	Qty.	Order No.
WMF 2.5 DI PE	50	1143030000
WMF 2.5 DI PE BL	50	1270080000

Accessories

Plug-in cross-connection	2-pole 10-pole
End plate / Partition plate	dark beige
End bracket	dark beige, screwable dark beige
Screwdriver	Standard
Holder for cartridge fuse 5 x 20 mm	400 V AC/DC, without LED 10 - 36 V AC/DC, red LED 140 - 250 V AC/DC, red LED
Module connector (max. 250 V)	without fittings with wire jumper With 1N4007 diode
Disconnect plug	removable, as replacement for release lever
Marking tags	

Type	Qty.	Order No.
ZQV 2.5N/2	24 A 60	1527540000
ZQV 2.5N/10	24 A 20	1527690000
AP WMF2.5	50	1142990000
WEW 35/1	50	1059000000
SDS 0.6X3.5X100	1	2749340000
SIHA 3/G20	6.3 A 25	7921560000
SIHA 3/G20/LD 10-36V	25	7921570000
SIHA 3/G20/LD 140-250V	25	7921600000
FUCR SW	10	1167630000
FUCR 10-36V SW	10	1167640000
FUCR 100-250V SW	10	1167680000
BEST	50	1833100000
BEST/DRBR	22 A 50	1878570000
BEST/D	1 A 50	1878560000
TNST	20 A 50	1833090000
DEK 5/5 MC NE WS	1000	1609801044
WS 10/5 MC NE WS	720	1635000000

For detailed information on other accessories and application in the online catalogue

Signal marshalling
Screw connection



Width/Height/Depth	mm
max. current / max. cond. cross-section	A
Max. clamping range	mm ²

Technical data

Rated data	
Rated voltage	V
Rated current	A
for wire cross-section	mm ²
Rated impulse withstand voltage / Pollution severity	
Gauge to IEC 60947-1 / UL 94 flammability rating	
Approvals	
Clamped conductors (H05V/H07V)	
Solid / Stranded	mm ²
Flexible / Flexible with ferrule	mm ²
Tightening torque / Clamping screw	Nm
Stripping length / Blade size	mm/-

Note

Ordering data

Version	Black
	10-36 V AC/DC, with LED
	30-70 V AC/DC, with LED
	60-150 V AC/DC, with LED
	100 - 250 V AC/DC, with LED

Note

Accessories

Plug-in cross-connection	2-pole
	10-pole
End plate / Partition plate	dark beige
End bracket	dark beige
Screwdriver	Standard
Holder for cartridge fuse 5 x 20 mm	400 V AC/DC, without LED
	10 - 36 V AC/DC, red LED
	140 - 250 V AC/DC, red LED
Module connector (max. 250 V)	without fittings
	with wire jumper
	With 1N4007 diode
Disconnect plug	removable, as replacement for release lever
Marking tags	

For detailed information on other accessories and application in the online catalogue

WMF 2.5 FU

2.5 mm²

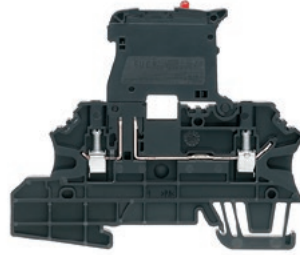

5.08 x 88 x 74
6.3 / 4
0.5...4

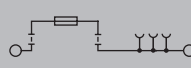

Ex ec II C GcII
3 G D

IEC	UL	CSA	EN 60079-7
36	600	600	
6.3	17	17	6.3
2.5	AWG 26...12	AWG 26...12	4 mm ²
8 kV / 3			
A3 / V-0			

Rated connection		
0.5...4 / 1.5...4		
0.5...4 / 0.5...2.5		
0.5...0.6 / (M 3)		
10 / 0.6 x 3.5 mm		

Type	Qty.	Order No.
WMF 2.5 FU SW	50	1162920000
WMF 2.5 FU 10-36V SW	50	1162930000
WMF 2.5 FU 30-70V SW	50	1162940000
WMF 2.5 FU 60-150V SW	50	1162950000
WMF 2.5 FU 100-250V SW	50	1162960000

The WMF FU terminals may not be aligned directly under one another.

Type	Qty.	Order No.
ZQV 2.5N/2	24 A 60	1527540000
ZQV 2.5N/10	24 A 20	1527690000
AP WMF2.5	50	1142990000
WEW 35/2	50	1061200000
SDS 0.6X3.5X100	1	2749340000
SIHA 3/G20	6.3 A 25	7921560000
SIHA 3/G20/LD 10-36V	25	7921570000
SIHA 3/G20/LD 140-250V	25	7921600000
FUCR SW	10	1167630000
FUCR 10-36V SW	10	1167640000
FUCR 100-250V SW	10	1167680000
BEST	50	1833100000
BEST/DRBR	22 A 50	1878570000
BEST/D	1 A 50	1878560000
TNST	20 A 50	1833090000
DEK 5/5 MC NE WS	1000	1609801044
WS 10/5 MC NE WS	720	1635000000

WMF 2.5 FU PE

2.5 mm²

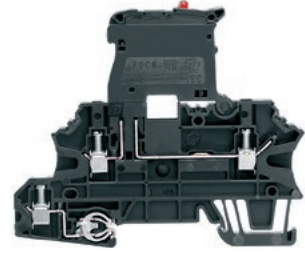

5.08 x 88 x 74
6.3 / 4
0.5...4

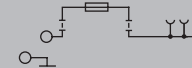

Ex ec II C GcII
3 G D

IEC	UL	CSA	EN 60079-7
36	600	600	
6.3	17	17	6.3
2.5	AWG 26...12	AWG 26...12	4 mm ²
8 kV / 3			
A3 / V-0			

Rated connection		
0.5...4 / 1.5...4		
0.5...4 / 0.5...2.5		
0.5...0.6 / (M 3)		
10 / 0.6 x 3.5 mm		

Type	Qty.	Order No.
WMF 2.5 FU PE SW	50	1163040000
WMF 2.5 FU PE 10-36V SW	50	1163050000
WMF 2.5 FU PE 30-70V SW	50	1163060000
WMF 2.5 FU PE 60-150V SW	50	1163070000
WMF 2.5 FU PE 100-250V SW	50	1163080000

The WMF FU terminals may not be aligned directly under one another.

Type	Qty.	Order No.
ZQV 2.5N/2	24 A 60	1527540000
ZQV 2.5N/10	24 A 20	1527690000
AP WMF2.5	50	1142990000
WEW 35/2	50	1061200000
SDS 0.6X3.5X100	1	2749340000
SIHA 3/G20	6.3 A 25	7921560000
SIHA 3/G20/LD 10-36V	25	7921570000
SIHA 3/G20/LD 140-250V	25	7921600000
FUCR SW	10	1167630000
FUCR 10-36V SW	10	1167640000
FUCR 100-250V SW	10	1167680000
BEST	50	1833100000
BEST/DRBR	22 A 50	1878570000
BEST/D	1 A 50	1878560000
TNST	20 A 50	1833090000
DEK 5/5 MC NE WS	1000	1609801044
WS 10/5 MC NE WS	720	1635000000





WMF 2.5 BLZ

2.5 mm²

WMF 2.5 DI BLZ

2.5 mm²

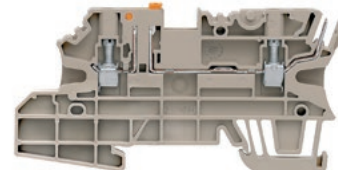
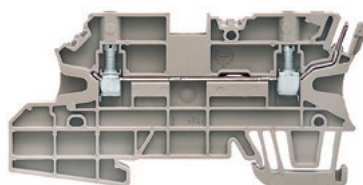

Width/Height/Depth	mm
max. current / max. cond. cross-section	A
Max. clamping range	mm ²

5.08 x 90 x 44.5	BLZ 5.08
32 / 4	
0.5...4	

5.08 x 90 x 44.5	BLZ 5.08
20 / 4	
0.5...4	

Technical data

Rated data	
Rated voltage	V
Rated current	A
for wire cross-section	mm ²
Rated impulse withstand voltage / Pollution severity	
Gauge to IEC 60947-1 / UL 94 flammability rating	
Approvals	
Clamped conductors (H05V/H07V)	
Solid / Stranded	mm ²
Flexible / Flexible with ferrule	mm ²
Tightening torque / Clamping screw	Nm
Stripping length / Blade size	mm/-

IEC 61984, In accordance with IEC 60947-7-1

IEC	UL	CSA	EN 60079-7
250	300	300	
24	20	26	
2.5	AWG 26...12	AWG 26...12	
8 kV / 3			
A3 / V-0			

IEC 61984, In accordance with IEC 60947-7-1

IEC	UL	CSA	EN 60079-7
250	300	300	
20	19	19	
2.5	AWG 26...12	AWG 26...12	
8 kV / 3			
A3 / V-0			

CE	
Rated connection	
0.5...4 / 1.5...4	
0.5...4 / 0.5...2.5	
0.5...0.6 Nm / (M 3)	
10 / 0.6 x 3.5 mm	

CE	
Rated connection	
0.5...4 / 1.5...4	
0.5...4 / 0.5...2.5	
0.5...0.6 Nm / (M 3)	
10 / 0.6 x 3.5 mm	

Note

With BLZ plug the nominal current is reduced to 15.5 A.

With BLZ plug the nominal current is reduced to 15.5 A.

Ordering data

Version	dark beige
Note	

Type	Qty.	Order No.
WMF 2.5 BLZ	50	1143050000

Type	Qty.	Order No.
WMF 2.5 DI BLZ	50	1143000000

Accessories

Plug-in cross-connection	2-pole 10-pole
End plate / Partition plate	dark beige
End bracket	dark beige, screwable dark beige
Screwdriver	Standard
Holder for cartridge fuse 5 x 20 mm	400 V AC/DC, without LED 10 - 36 V AC/DC, red LED 140 - 250 V AC/DC, red LED
Module connector (max. 250 V)	without fittings with wire jumper With 1N4007 diode
Disconnect plug	removable, as replacement for release lever
Marking tags	

Type	Qty.	Order No.
ZQV 2.5N/2	24 A 60	1527540000
ZQV 2.5N/10	24 A 20	1527690000
AP WMF2.5	50	1142990000
WEW 35/2	50	1061200000
SDS 0.6X3.5X100	1	2749340000
DEK 5/5 MC NE WS	1000	1609801044
WS 10/5 M MC NE WS	720	1792000000

Type	Qty.	Order No.
ZQV 2.5N/2	24 A 60	1527540000
ZQV 2.5N/10	24 A 20	1527690000
AP WMF2.5	50	1142990000
WEW 35/1	50	1059000000
SDS 0.6X3.5X100	1	2749340000
SIHA 3/G20	6.3 A 25	7921560000
SIHA 3/G20/LD 10-36V	25	7921570000
SIHA 3/G20/LD 140-250V	25	7921600000
FUCR SW	10	1167630000
FUCR 10-36V SW	10	1167640000
FUCR 100-250V SW	10	1167680000
BEST	50	1833100000
BEST/DRBR	22 A 50	1878570000
BEST/D	1 A 50	1878560000
TNST	20 A 50	1833090000
DEK 5/5 MC NE WS	1000	1609801044
WS 10/5 MC NE WS	720	1635000000

For detailed information on other accessories and application in the online catalogue

Signal marshalling
Screw connection



WMF 2.5 DI BLZ PE

2.5 mm²

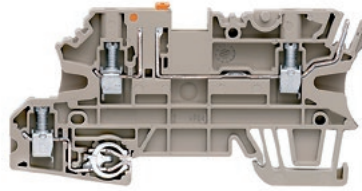

Width/Height/Depth	mm
max. current / max. cond. cross-section	A
Max. clamping range	mm ²

5.08 x 90 x 44.5	BLZ 5.08
20 / 4	
0.5...4	

Technical data

Rated data	
Rated voltage	V
Rated current	A
for wire cross-section	mm ²
Rated impulse withstand voltage / Pollution severity	
Gauge to IEC 60947-1 / UL 94 flammability rating	
Approvals	
Clamped conductors (H05V/H07V)	
Solid / Stranded	mm ²
Flexible / Flexible with ferrule	mm ²
Tightening torque / Clamping screw	Nm
Stripping length / Blade size	mm/-

IEC 60947-7-2, IEC 61984, In accordance with IEC 60947-7-1

IEC	UL	CSA	EN 60079-7
250	300	300	
20	19	19	
2.5	AWG 26...12	AWG 26...12	
8 kV / 3			
A3 / V-0			

CE

Rated connection	
0.5...4 / 1.5...4	
0.5...4 / 0.5...2.5	
0.5...0.6 Nm / (M 3)	
10 / 0.6 x 3.5 mm	

Note

With BLZ plug the nominal current is reduced to 15.5 A.

Ordering data

Version	dark beige
Note	

Type	Qty.	Order No.
WMF 2.5 DI BLZ PE	50	1143010000

Accessories

Plug-in cross-connection	
	2-pole
	10-pole
End plate / Partition plate	
	dark beige
End bracket	
	dark beige, screwable
	dark beige
Screwdriver	
	Standard
Holder for cartridge fuse 5 x 20 mm	
	400 V AC/DC, without LED
	10 - 36 V AC/DC, red LED
	140 - 250 V AC/DC, red LED

Type	Qty.	Order No.
ZQV 2.5N/2	24 A 60	1527540000
ZQV 2.5N/10	24 A 20	1527690000
AP WMF2.5	50	1142990000
WEW 35/1	50	1059000000
SDS 0.6X3.5X100	1	2749340000
SIHA 3/G20	6.3 A 25	7921560000
SIHA 3/G20/LD 10-36V	25	7921570000
SIHA 3/G20/LD 140-250V	25	7921600000
FUCR SW	10	1167630000
FUCR 10-36V SW	10	1167640000
FUCR 100-250V SW	10	1167680000
BEST	50	1833100000
BEST/DRBR	22 A 50	1878570000
BEST/D	1 A 50	1878560000
TNST	20 A 50	1833090000
DEK 5/5 MC NE WS	1000	1609801044
WS 10/5 MC NE WS	720	1635000000

Module connector (max, 250 V)	
	without fittings
	with wire jumper
	With 1N4007 diode
Disconnect plug	
	removable, as replacement for release lever
Marking tags	

For detailed information on other accessories and application in the online catalogue





WMF 2.5 FU BLZ

2.5 mm²

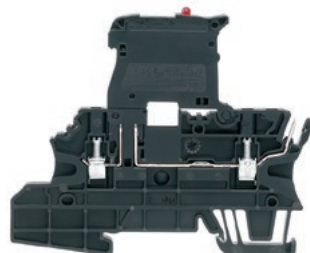

5.08 x 90 x 74
6.3 / 4
0.5...4

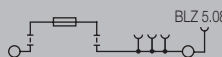

IEC 61984, In accordance with IEC 60947-7-1, IEC 60947-3

IEC	UL	CSA	EN 60079-7
36	300	300	
6.3	17	17	
2.5	AWG 26...12	AWG 26...12	
8 kV / 3			
A3 / V-0			

CE

Rated connection	
Solid / Stranded	0.5...4 / 1.5...4
Flexible / Flexible with ferrule	0.5...4 / 0.5...2.5
Tightening torque / Clamping screw	0.5...0.6 / (M 3)
Stripping length / Blade size	10 / 0.6 x 3.5 mm

Width/Height/Depth	mm
max. current / max. cond. cross-section	A
Max. clamping range	mm ²

Technical data

Rated data	
Rated voltage	V
Rated current	A
for wire cross-section	mm ²
Rated impulse withstand voltage / Pollution severity	
Gauge to IEC 60947-1 / UL 94 flammability rating	
Approvals	
Clamped conductors (H05V/H07V)	
Solid / Stranded	mm ²
Flexible / Flexible with ferrule	mm ²
Tightening torque / Clamping screw	Nm
Stripping length / Blade size	mm/-

Note

Ordering data

Version	
	Black
	10-36 V AC/DC, with LED
	30-70 V AC/DC, with LED
	60-150 V AC/DC, with LED
	100 - 250 V AC/DC, with LED
Note	

Accessories

Plug-in cross-connection	
	2-pole
	10-pole
End plate / Partition plate	dark beige
End bracket	dark beige, screwable
Screwdriver	Standard
Holder for cartridge fuse 5 x 20 mm	
	400 V AC/DC, without LED
	10 - 36 V AC/DC, red LED
	140 - 250 V AC/DC, red LED
Module connector (max. 250 V)	
	without fittings
	with wire jumper
	With 1N4007 diode
Disconnect plug	removable, as replacement for release lever
Marking tags	

For detailed information on other accessories and application in the online catalogue

WMF 2.5 FU BLZ PE

2.5 mm²

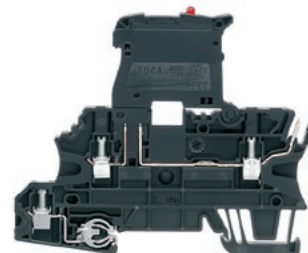

5.08 x 90 x 74
6.3 / 4
0.5...4

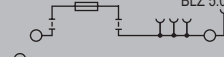

IEC 60947-7-2, IEC 61984, In accordance with IEC 60947-7-1, IEC 60947-3

IEC	UL	CSA	EN 60079-7
36	300	300	
6.3	17	17	
2.5	AWG 26...12	AWG 26...12	
8 kV / 3			
A3 / V-0			

CE

Rated connection	
Solid / Stranded	0.5...4 / 1.5...4
Flexible / Flexible with ferrule	0.5...4 / 0.5...2.5
Tightening torque / Clamping screw	0.5...0.6 / (M 3)
Stripping length / Blade size	10 / 0.6 x 3.5 mm

Note

Ordering data

Type	Qty.	Order No.
WMF 2.5 FU BLZ PE SW	50	1162820000
WMF 2.5 FU BLZ PE 10-36V SW	50	1162830000
WMF 2.5 FU BLZ PE 100-250V SW	50	1162860000

Accessories

Plug-in cross-connection	
	2-pole
	10-pole
End plate / Partition plate	dark beige
End bracket	dark beige, screwable
Screwdriver	Standard
Holder for cartridge fuse 5 x 20 mm	
	400 V AC/DC, without LED
	10 - 36 V AC/DC, red LED
	140 - 250 V AC/DC, red LED
Module connector (max. 250 V)	
	without fittings
	with wire jumper
	With 1N4007 diode
Disconnect plug	removable, as replacement for release lever
Marking tags	

For detailed information on other accessories and application in the online catalogue

Signal marshalling Accessories

BLZP 5.08HC../90

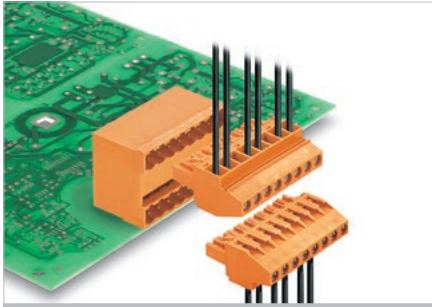

The BLZP is the functional extension of the BLZ series. The "P" in the part name stands for a plus in security and performance in processing and use.

- WIRE READY - delivered with terminal points already opened
- Power tools can be used with the globally compatible plus/minus screw head
- Folded steel clamping yoke accommodates the connected wire and compensates for temperature fluctuations
- The integrated wire guard prevents dangerous under-insertion of the wire from occurring.
- Lock and release-lever: tool-less locking and gentle releasing of the connector reduces the mechanical stress on the solder joints.

Product data

IEC: 400 V / 23 A / 0.2 - 4 mm²
UL: 300 V / 20 A / AWG 26 - 12



For additional articles and information, refer to catalog.weidmueller.com

Note:

- Additional variants on request
- Gold-plated contact surfaces on request
- Rated current related to rated cross-section & min. No. of poles.
- Wire end ferrule without plastic collar to DIN 46228/1
- Wire end ferrule with plastic collar to DIN 46228/4
- P on drawing = pitch
- Rated data refer only to the component itself. Clearance and creepage distances to other components are to be designed in accordance with the relevant application standards.
- Long term storage of the product with average temperature of 50 °C and average humidity 70%, 36 months

BLZP 5.08HC../90



Dimensioned drawing

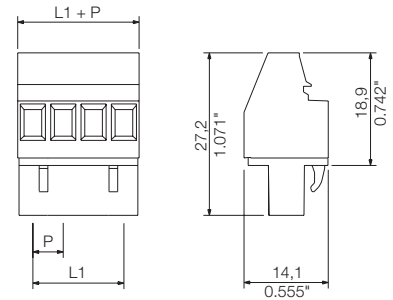

Technical data

In compliance with IEC 60664-1 / IEC 61984

Clamping range, max.	mm ²	0.13...4
Solid core H05(07) V-U	mm²	0.2...4
Stranded H07 V-R		
Flexible H05(07) V-K	mm ²	0.2...4
Flexible with ferrule	mm ²	0.2...4
Ferrule with plastic collar	mm ²	0.2...2.5
Stripping length	mm	7
Screwdriver blade	mm	0.6 x 3.5, PH 1, PZ 1

According to norm

Tightening torque range

Rated current, max.	A	23	21
----------------------------	----------	-----------	-----------

At ambient temperature 20°C 40°C

For conductor cross-section	mm ²	4
-----------------------------	-----------------	---

Overvoltage category		III	III	II
----------------------	--	-----	-----	----

Pollution severity		3	2	2
--------------------	--	---	---	---

Rated voltage	V	250	320	400
----------------------	----------	------------	------------	------------

Rated impulse voltage	kV	4	4	4
-----------------------	----	---	---	---

UL / CUL (Use Group)	B	C	D
-----------------------------	----------	----------	----------

Rated voltage	V	300	300
----------------------	----------	------------	------------

Rated current	A	20	10
----------------------	----------	-----------	-----------

AWG conductor	AWG	26-12
----------------------	------------	--------------

CSA (Use Group)	B	C	D
------------------------	----------	----------	----------

Rated voltage	V	300	50	300
---------------	---	-----	----	-----

Rated current	A	20	20
---------------	---	----	----

AWG conductor	AWG	30-12
---------------	-----	-------

General data

Type of insulation material		PBT
-----------------------------	--	-----

UL 94 flammability rating		V-0
---------------------------	--	-----

Contact base material		Copper alloy
-----------------------	--	--------------

Material of contact surface		tinned
-----------------------------	--	--------

Pin dimensions = d	mm	
--------------------	----	--

Solder eyelet Ø = D	mm	
---------------------	----	--

Solder eyelet Ø tolerance	mm	
---------------------------	----	--

Accessories

Note: Refer to the Accessories chapter for additional accessories.

Coding	Order No.
BLZ/SL KO OR BX	1573010000
BLZ/SL KO BK BX	1545710000
Screwdriver	
SDS 0.6X3.5X100	2749340000
SDIS 0.6X3.5X100	2749810000
SDK PH1 X 80	2749410000
SDK PZ1 X 80	2749440000

Ordering data

Solder pin length

Colour	orange
--------	---------------

Pitch 5.08 mm

Pol.	L1	(inch)	Qty.	Order No.
2	5.08	0.200	180	1948000000
3	10.16	0.400	120	1948010000
4	15.24	0.600	90	1948020000
5	20.32	0.800	72	1948030000
6	25.40	1.000	60	1948040000
7	30.48	1.200	48	1948050000
8	35.56	1.400	42	1948060000
9	40.64	1.600	36	1948070000
10	45.72	1.800	36	1948080000
11	50.80	2.000	30	1948100000
12	55.88	2.200	30	1948110000

Representative deratings curve

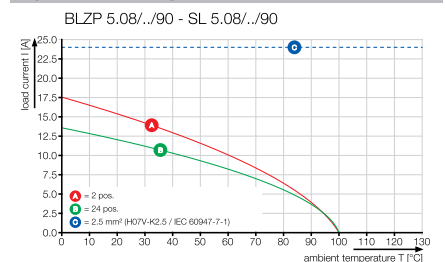

BLZP 5.08HC../90F



Dimensioned drawing

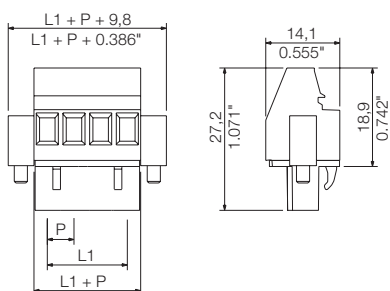

The 2-in-1 contact

Every pluggable connector covers two contact points and thus must meet two different requirements: First, the wire termination and second, the connection between plug and pin header. Referring to the 5.0x pitch series, Weidmüller offers different wire connection technologies, but one platform contact for the male / female connection since years. This well-designed hybride platform contact ensures a constant quality on a very high level. Hybride means, that we combine metal material featuring different characteristics by welding, in order to devide the contact system into different function zones: Further to the high electric conductance, the current bar is characterized by its hardness, and the tulip contact by its excellent tension properties. The advantage: each function is supported by the most suitable material to reliably and constantly meet the different electrical and mechanical requirements. To put it in a nutshell: Instead of either ... or, it 's even both - perfect for the current, and perfect for the force.



Ordering data

Solder pin length				
Colour	orange			
Pitch	5.08 mm			
Pol.	L1	(inch)	Qty.	Order No.
2	5.08	0.200	90	1949800000
3	10.16	0.400	72	1949810000
4	15.24	0.600	60	1949820000
5	20.32	0.800	48	1949830000
6	25.40	1.000	42	1949840000
7	30.48	1.200	36	1949850000
8	35.56	1.400	36	1949860000
9	40.64	1.600	30	1949870000
10	45.72	1.800	30	1949880000
11	50.80	2.000	24	1949890000
12	55.88	2.200	24	1949900000



IL WMF 2.5 BLZ OR



Ordering data
Note

Type	Qty.	Order No.
IL WMF2.5 BLZ OR	50	1167440000

WAD WMF 2.5



Type	Qty.	Order No.
WAD WMF2.5	50	1142970000

WBB WMF 2.5 BLZ

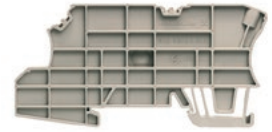

Type	Qty.	Order No.
WBB WMF2.5 BLZ	10	1142980000

AP WMF 2.5



Ordering data
Note

Type	Qty.	Order No.
AP WMF2.5	50	1142990000

FUCR SW



Type	Qty.	Order No.
FUCR 10-36V SW	10	1167640000

Support plates and end plates

PAP PRV/PPV4



Ordering data	Blue	PAP PRV/PPV4 BL	10	1268010000
	grey	PAP PRV/PPV4 GR	10	1211450000
	Black	PAP PRV/PPV4 SW	10	1173750000
Note				

PAP PRV/PPV8



Type	Qty.	Order No.
PAP PRV/PPV8 GR	10	1211460000
PAP PRV/PPV8 SW	10	1173720000



Safe, error-free plant operation

Efficient shielding and earthing with Klippon® Connect



The safety and availability of plants must be guaranteed at all times. Careful planning and installation of safety functions play a particularly important role. For personnel protection, we offer a wide range of PE terminal blocks in different connection technologies. With our wide range of KLBÜ shield connections, you can achieve flexible and self-adjusting shield contacting and ensure error-free plant operation.

Our promise

Klippon® Connect reliably guarantees the protection of personnel and machines and increases plant availability. You can improve your productivity and benefit from more efficient planning and increased safety during installation and operation.

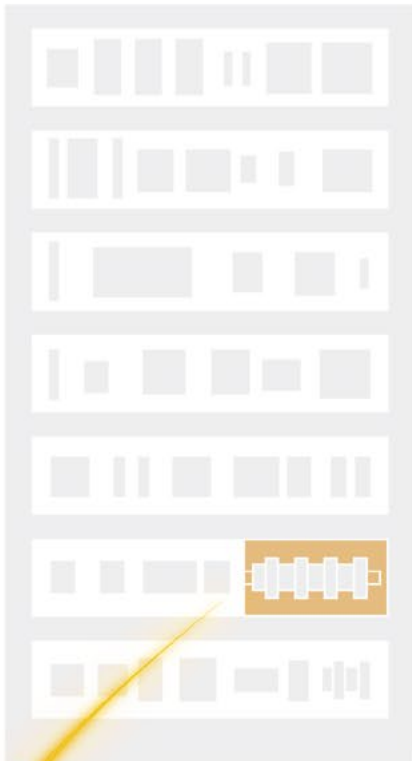

B



Safety

- The spring system on the shield connection compensates for temperature-related diameter deviation of the cable
- Reliable protection against transient overvoltage and electromagnetic fields
- Consistent contact pressure thanks to spring effect

Space saving

- Complete range for conductor diameters from 2 to 37 mm to meet all space requirements
- Perfect shielding thanks to comprehensive accessories

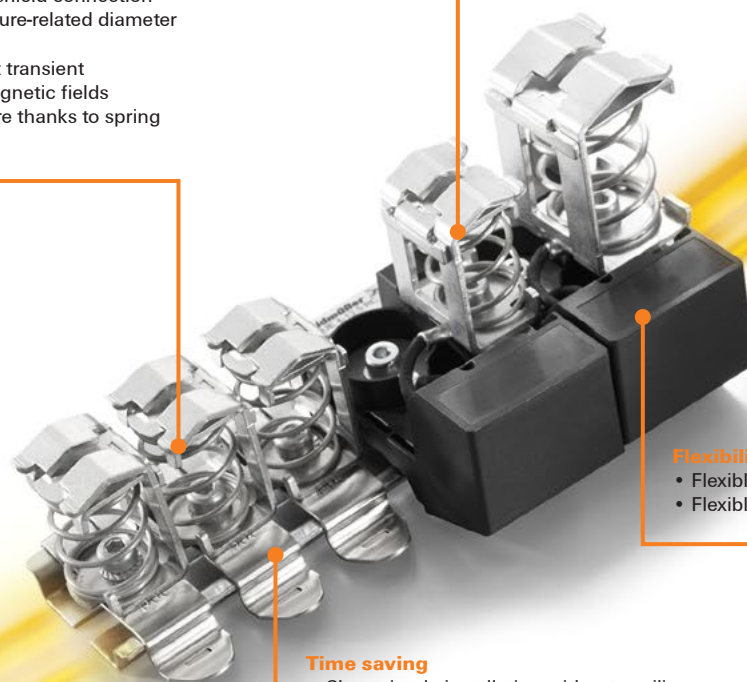
**Flexibility**

- Flexible mounting options
- Flexible adaptation to cable diameters

Time saving

- Clear, simple installation without auxiliary tools
- The right solution for every installation situation

Our range**Shielding:**

Our complete range of KLBÜ shield connections, KHLA shield clamping saddles, SH 4C shield rail holders and KLBÜ RC shielding brackets allows simple and efficient installation of safe shielding systems.

**Protective earth (PE):**

We offer a wide range of green/yellow terminal blocks in screw connection, tension clamp and PUSH IN designs.

**Potential equalisation:**

Our JB 25-50 and EBB 25-50/16 potential equalisation terminal blocks allow you to achieve reliably integrated potential equalisation, even in extended systems.



Entry:

Electromagnetic Compatibility

The term Electromagnetic Compatibility (EMC) describes the ability of electrical equipment to function faultlessly in an electromagnetically-loaded environment, e.g. in an industrial plant, without influencing the environment. The consequences of an inadequate EMC can range from disturbances in normal use to damage or destruction of equipment with the added risks of economic damage and/or personal injury.

Interference sources

Sources of interference exist in many forms. But the common feature of all interference sources is the emission of electronic or magnetic energy, which influences electrical equipment and prevents fault-free operation. A distinction is made between natural sources of interference such as atmospheric discharge or electrostatic discharge and artificial sources of interference such as radio (intentional) or frequency converters (unintentional).

Interference sinks

Interference sinks encompass electrical equipment that can be influenced by sources of interference. Electromagnetic pulses can cause equipment to be disturbed, damaged or destroyed. Other consequences could be the total failure of a piece of equipment, or a system with economic or material damage, or even personal injury.

Coupling

Coupling is the transmission of electrical energy from one electric circuit to another.

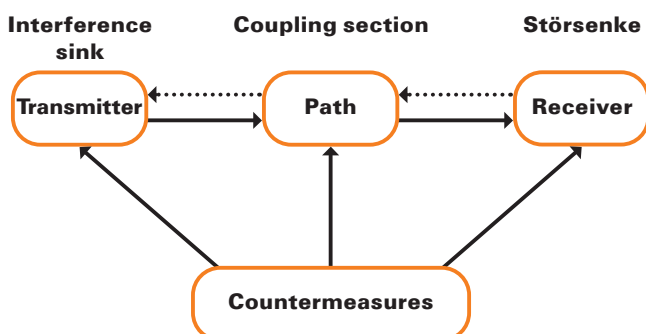

Actions:

Measures to improve electromagnetic compatibility

In order to guarantee EMC, the interference mechanisms must first be known. In addition to natural sources of interference such as lightning, there are also so-called coupling mechanisms. Here is an overview of the different coupling mechanisms as well as some measures for EMC optimisation.

Coupling mechanisms:

Galvanic coupling

Coupling of two circuits via a common current path.

Capacitive (electrical) coupling

Coupling of two circuits via an alternating electric field (mainly in the high-frequency range).

Inductive (magnetic) coupling

Coupling of two circuits via an alternating magnetic field (mainly in the low-frequency range).

Radiation coupling (electromagnetic coupling)

Emission of wave fields with electric and magnetic field strength.

Measures for EMC optimisation:

The most frequently used and sensible countermeasures to improve EMC are the use of twisted or shielded cables.

Use of shielded cables

The task of an electromagnetic screen is to close its internally generated electromagnetic field and prevent it from propagating or to create a space free of external fields..

The interference to be expected determines the shield connection

In order to suppress electric fields, a one-sided grounding of the shield is necessary. To suppress an alternating magnetic field, the shield must be grounded on both sides. However, if the shield is connected on both sides, a ground loop occurs, which in turn has disadvantages. The useful signal is influenced in particular by interference along the reference potential and thus a deterioration occurs. In this case, triaxial cables can help by connecting the inner shield on one side and the outer shield on both sides. A capacitor is often connected to the reference potential on one side to reduce such interference. This interrupts the earth loop for direct currents or low-frequency currents.

Implementation of shielding in practice

With the KLBUE, Weidmueller has developed a versatile product designed to reduce EMV in plants and equipment. to improve machines.



Schematic representation

Different contacting possibilities of the cable screen

Shielding on both sides



To protect against possible interference effects alternating magnetic field is bilateral Hang up unavoidable. This does mean a risk of ground loops forming. However cable shields and steel conduits should be grounded on both sides, despite the risk, as today's EMC regulations require this. In the same way, shields of two-sided signal conductors should be grounded on both sides.

One sided shielding



If shielding is to be used to protect against electrical fields, it is advisable to ground on one side only. Shields of analogue signal conductors should, for example, be connected at one end.

B



Stripping tool for shielded cables

With the Weidmüller AM 16 stripping tool, it is very easy to disconnect the insulation of a conductor and then apply the shield. The insulation can be cut at any point on the conductor. The insulation of the conductor is first separated over the circumference. Then the tool is pulled lengthwise over the conductor and so the insulation is cut off. Finally, the insulation is cut at the other end over the circumference. The illustration shows the resulting pattern.

Shield connection terminals KLBUE

Cable attached to the busbar from above

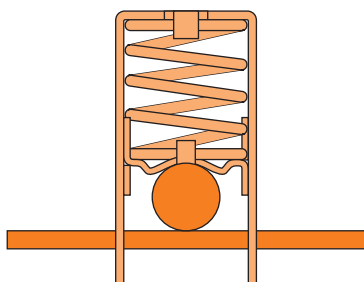

KLBÜ CO 1

KLBÜ CO 2

KLBÜ CO 3

KLBÜ CO 4

KLBÜ CO 5

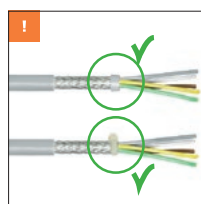
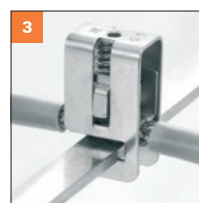

KLBUE CO

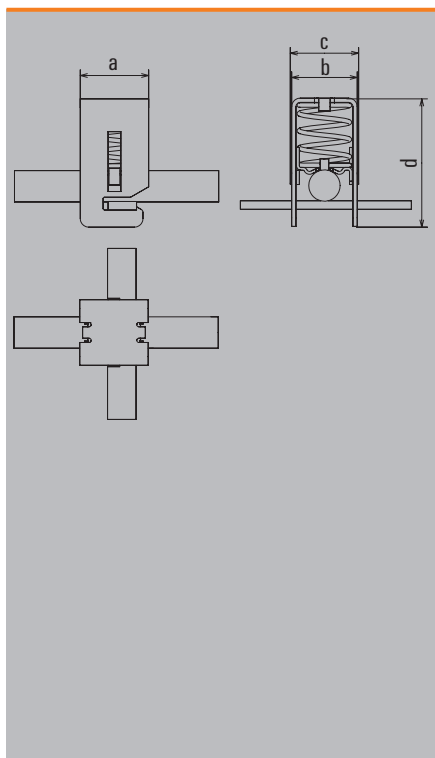

Ordering data

Type	for cable diameters	Dimensions (a x b x c x d) mm	Qty.	Order No.
Clamping bracket				
KLBUE CO 1	3...10 mm	18 / 12 / 13.2 / 32	10	1753311001
KLBUE CO 2	4...15 mm	18 / 20 / 21.1 / 41.6	10	1752131001
KLBUE CO 3	10...20 mm	25 / 23 / 24 / 45	10	1749151001
KLBUE CO 4	15...28 mm	32 / 31 / 25 / 56	10	1749161001
KLBUE CO 5	20...37 mm	35.5 / 40 / 42.7 / 64.5	10	1755081001

Type	Length	Material	Qty.	Order No.
Busbar 10 x 3 (140 A)				
SSCH 10X3X1000 CU/SN		Copper	1	0348900000

Note



Shielding and earthing
Shield clamping saddle

Shield connection terminals KLBUE

Cable attached to the busbar from below

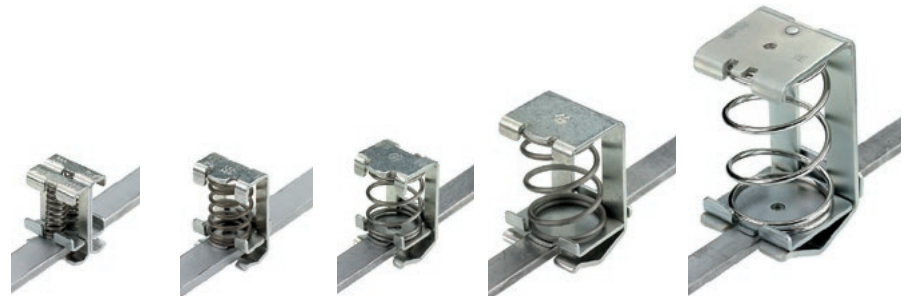
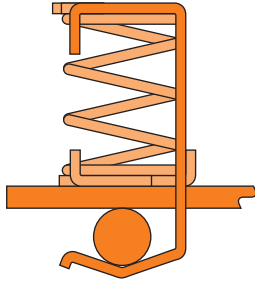

KLBÜ 2 x 2-6

KLBÜ 3-8

KLBÜ 4-13.5

KLBÜ 10-20

KLBÜ 15-32

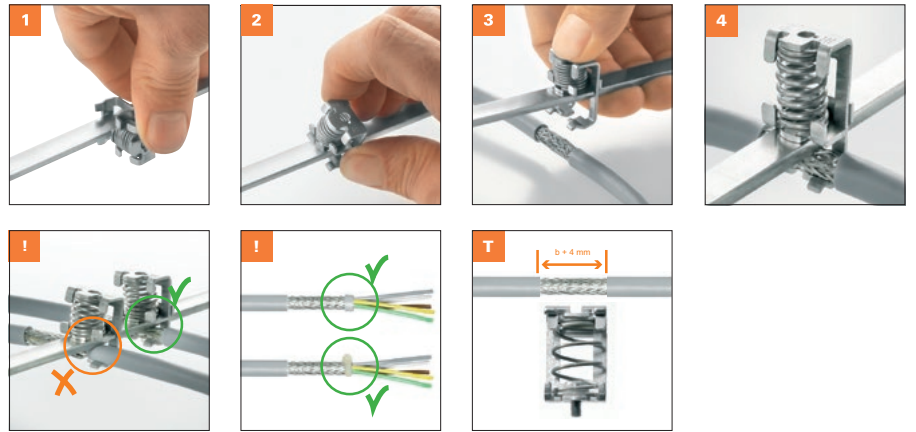

B

KLBUE

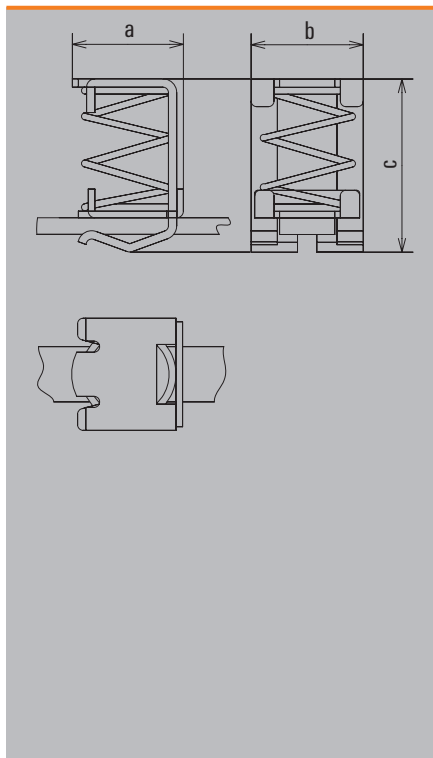

Ordering data

Type	for cable diameters	Dimensions (a x b x c) mm	Qty.	Order No.
Clamping bracket				
KLBUE 2X2-6	2...6 mm	15 / 18 / 24	10	1675350000
KLBUE 3-8	3...8 mm	14.5 / 18.5 / 26	10	1600480000
KLBUE 4-13.5	4...13.5 mm	20.5 / 22 / 31.5	10	1592810000
KLBUE 10-20	10...20 mm	24 / 26 / 40	10	1600490000
KLBUE 15-32	15...32 mm	33.5 / 32 / 64	10	1716300000

Type	Length	Material	Qty.	Order No.
Busbar 10 x 3 (140 A)				
SSCH 10X3X1000 CU/SN		Copper	1	0348900000

Note

Shield connection terminals KLBUE

Cable attached on the mounting plate from above

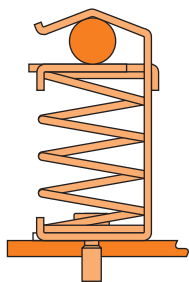

SCH-1-WB



KLBÜ 3-8 SC



KLBÜ 4-13,5 SC



KLBÜ 10-20 SC



KLBÜ 15-32 SC

Drilling template KLBÜ 15-32 SC

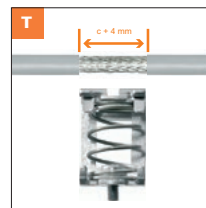
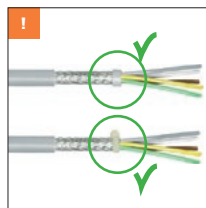
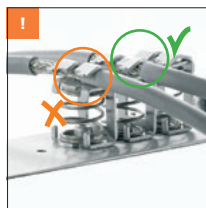
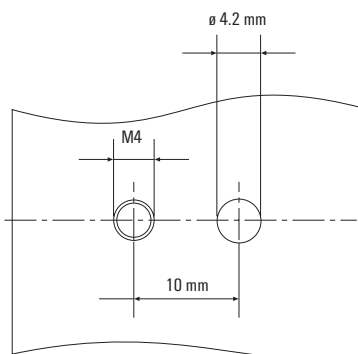

KLBUE SC

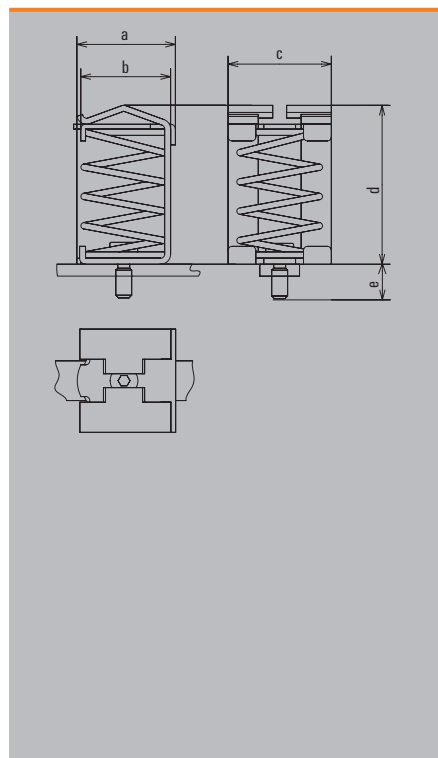

Ordering data

Type	for cable diameters	Length of thread	Dimensions (a x b x c x d) mm	Qty.	Order No.
Clamping bracket					
KLBUE 3-8 SC	3...8 mm	5.65 mm	14.5 / / 18.5 / 26	10	1692261001
KLBUE 4-13.5 SC	4...13.5 mm	5.3 mm	20.1 / / 22 / 31.45	10	1712311001
KLBUE 10-20 SC	10...20 mm	5.3 mm	23.6 / / 26 / 40	10	1712321001
KLBUE 15-32 SC	15...32 mm	4.8 mm	33.25 / / 32 / 63.9	10	1718341001

Note

Shield connection terminals KLBUE

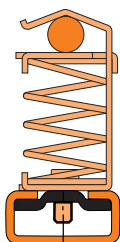

KLBÜ 3-8 CPF

KLBÜ 4-13,5 CPF

KLBÜ 10-20 CPF

KLBÜ 15-32 CPF

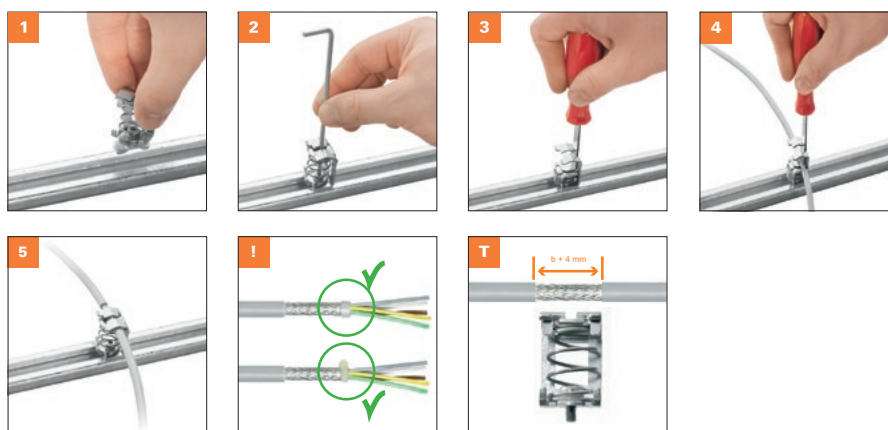

KLBUE CPF

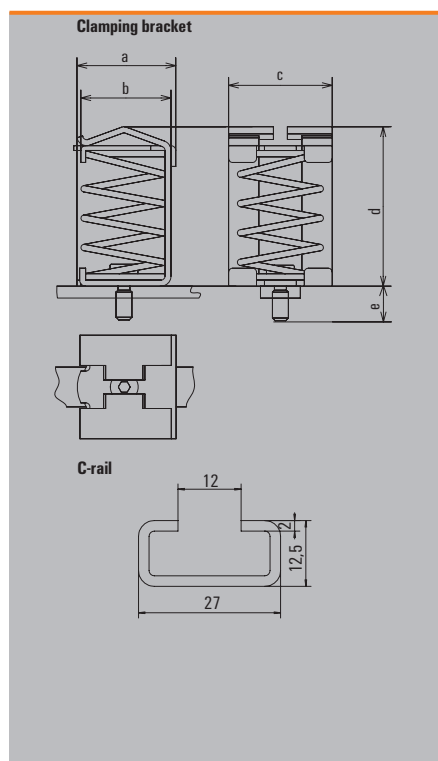

Ordering data

Type	for cable diameters	Dimensions (a x b x c x d) mm	Qty.	Order No.
Type for 12 mm profile				
KLBUE 3-8 CPF	3...8 mm	14.5 / 13.5 / 18 / 26	10	1752681001
KLBUE 4-13.5 CPF	4...13.5 mm	20.5 / 19 / 22 / 31.5	10	1752691001
KLBUE 10-20 CPF	10...20 mm	24 / 22.5 / 26 / 39.5	10	1752701001
KLBUE 15-32 CPF	15...32 mm	33.5 / / 32 / 64	10	1752711001

Note

Clamping bracket holder

FM 4 foot



KLBÜ SC-type clamping brackets
(see previous page)
are screwed on to the FM 4foot



KLBÜ 4-13.5 FM4

Clamping bracket holder

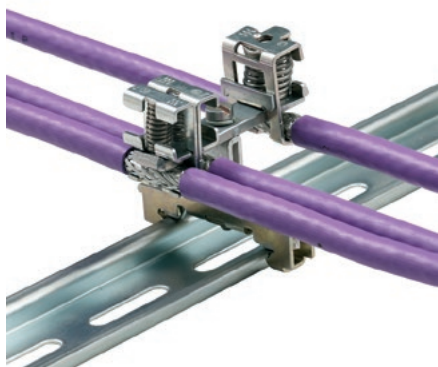

BS 35 II (without KLBÜ)

BS 35 II / KLBÜ 3-8

BS 35 II / KLBÜ 3-8 / 2 x 2-6

Clamping yoke holder

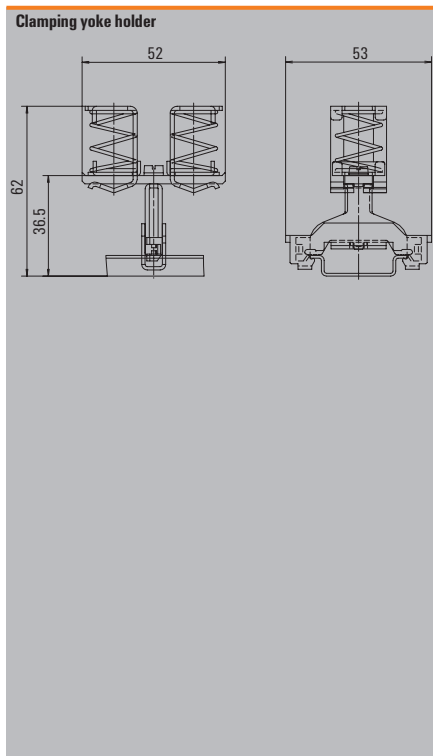

Ordering data

Type	for cable diameters	Qty.	Order No.
Clamping bracket fitted with FM 4 foot			
KLBUE 3-8 FM4	3...8 mm	10	1252530000
KLBUE 4-13.5 FM4	4...13.5 mm	10	1252520000
KLBUE 10-20 FM4	10...20 mm	10	1252510000
KLBUE 15-32 FM4	15...32 mm	10	1252490000
Clamping bracket holder			
BS 35II KLBUE HOLDER		10	1723800000
BS 35II KLBUE3-8	3...8	10	1723810000
BS 35II/KLBUE 4-13.5	4...13.5	10	1723820000
BS 35II KLBUE3-8/2X2-6	3...8	10	1749430000
BS 35II KLBUE2X3-8/2X2-6	3...8	10	1768020000

Note



Shielding and earthing Shield clamping saddle

Shielding solutions for direct connection

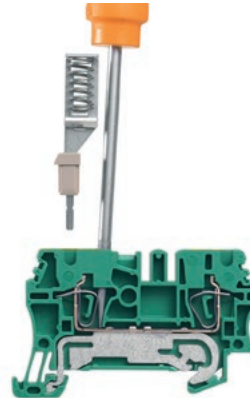

KLBÜ 4-6 Z/1

B

Ordering data

Type	for cable diameters	Qty.	Order No.
Type for 12 mm profile			
KLBUE 4-6 Z/1	4..6	10	2269800000

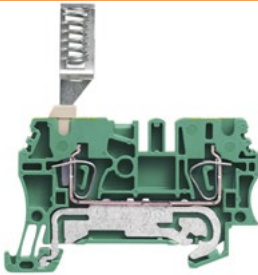

Note

suitable for Z series 2.5 mm²

Rail support / Spacer

Rail support

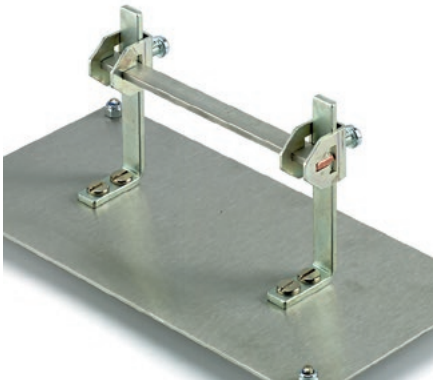

- Set (WSH 4 MT) comprising:
- 1 busbar angle
 - 1 busbar connector (BFEH 1 / WSH)

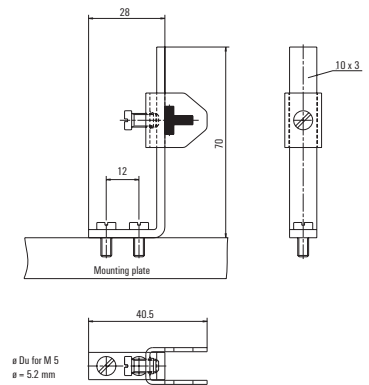

Spacer



M6 outer and inner threads
(in 15 mm, 20 mm and 30 mm lengths)



WSH 4 MT / SP

Ordering data

Type	Length	Qty.	Order No.
Busbar support			
WSH 4 MT		10	1079900000
SH 4C		10	1340870000
Spacer			
SP M6 15 MSZN		1	3896100000
SP M6 20 MSZN		2	3896200000
SP M6 30 MSZN		2	3896300000

Note



Shielding and earthing
Shield clamping saddle

Rail support

Isolated mounting on TS 35

Type WSH 1

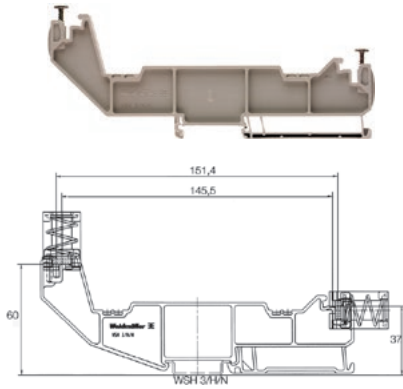

Type WSH 3/H/N

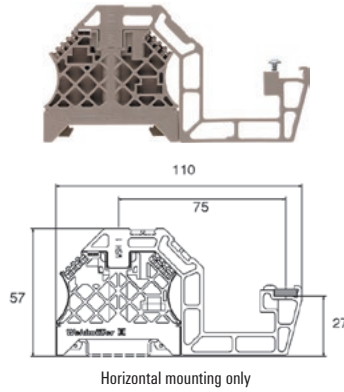

Type WSH 5

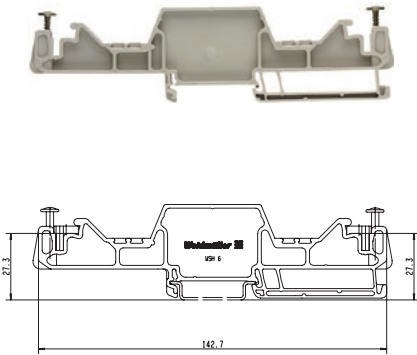

Type WSH 6

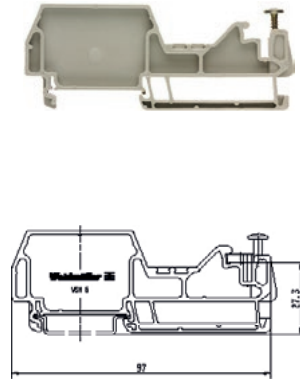

WSH

Ordering data

Type	Width	Qty.	Order No.
Rail support			
WSH 1	8 mm	10	1068700000
WSH 3/H/N	8 mm	10	1715970000
WSH 5	8 mm	10	1080100000
WSH 6	8 mm	10	1080200000

Type	Length	Material	Qty.	Order No.
Busbar 10 x 3 (140 A)				
SSCH 10X3X1000 CU/SN		Copper	1	0348900000

Note

Rail support

Conductive mounting on TS 35

TS 35 clip

BS 35/WSH 2

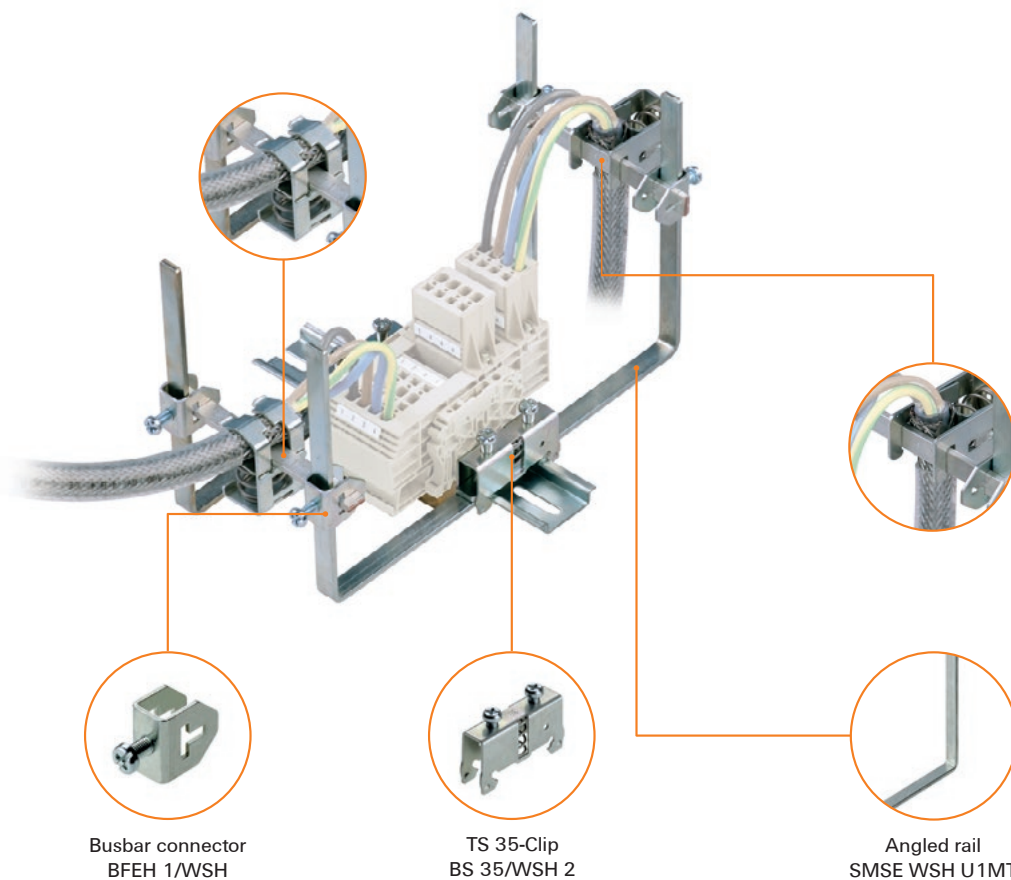

Busbar connector
BFEH 1/WSH

TS 35-Clip
BS 35/WSH 2

Angled rail
SMSE WSH U1MT

WSH

Ordering data

Type	Dimensions (H x W x D) mm	Qty.	Order No.
TS 35 clip			
BS 35/WSH 2	52 / 13 / 37	10	1760720000
Busbar connector			
BFEH 1/WSH	20 / 13.5 / 31	10	1082400000
Angled rail			
SMSE WSH U1 MT	134 / 10 / 134	10	1083900000
SMSE WSH 135/60 MT	123.5 / 10 / 3	10	1246990000
Rail support sets			
WSH 18 MT		10	1083100000
WSH 19 MT		10	1083200000

Type	Length	Material	Qty.	Order No.
Busbar 10 x 3 (140 A)				
SSCH 10X3X1000 CU/SN		Copper	1	0348900000

Note

Discharge of interference currents without different ground levels Klippon® Connect shielding bracket KLBÜ with filter

If possible, interference currents should be discharged at the near end of the line. However, distant ground levels usually cause unwanted equalizing currents. KLBÜ RC shielding brackets enable the optimal discharge of interference currents without different ground levels, as well as the associated equipotential bonding and the capacitance coating on the cable. The built-in high-pass filter blocks low-frequency currents and at the same time ensures safe noise conduction at the near end.

B

Tested vibration safety

The KLBÜ-RC series has been tested for vibration. It meets the requirements of railroad and wind power plants and can be used in mobile installations.

Integrated high pass
The frequency filter in the shielding bracket prevents potential carry over the line shield. Disturbing equalizing currents are effectively suppressed.

Large-area labeling

The carrier housing offers sufficient space to clearly mark the component with the SM 27/8 marker. Color differentiation makes the marking particularly clear.

Flexible mounting

Whether top-hat rail TS 35 or the C-rail TS 27: The support system is flexible thanks to two flexible mounting options. The active shielding bracket adapts optimally to its environment.

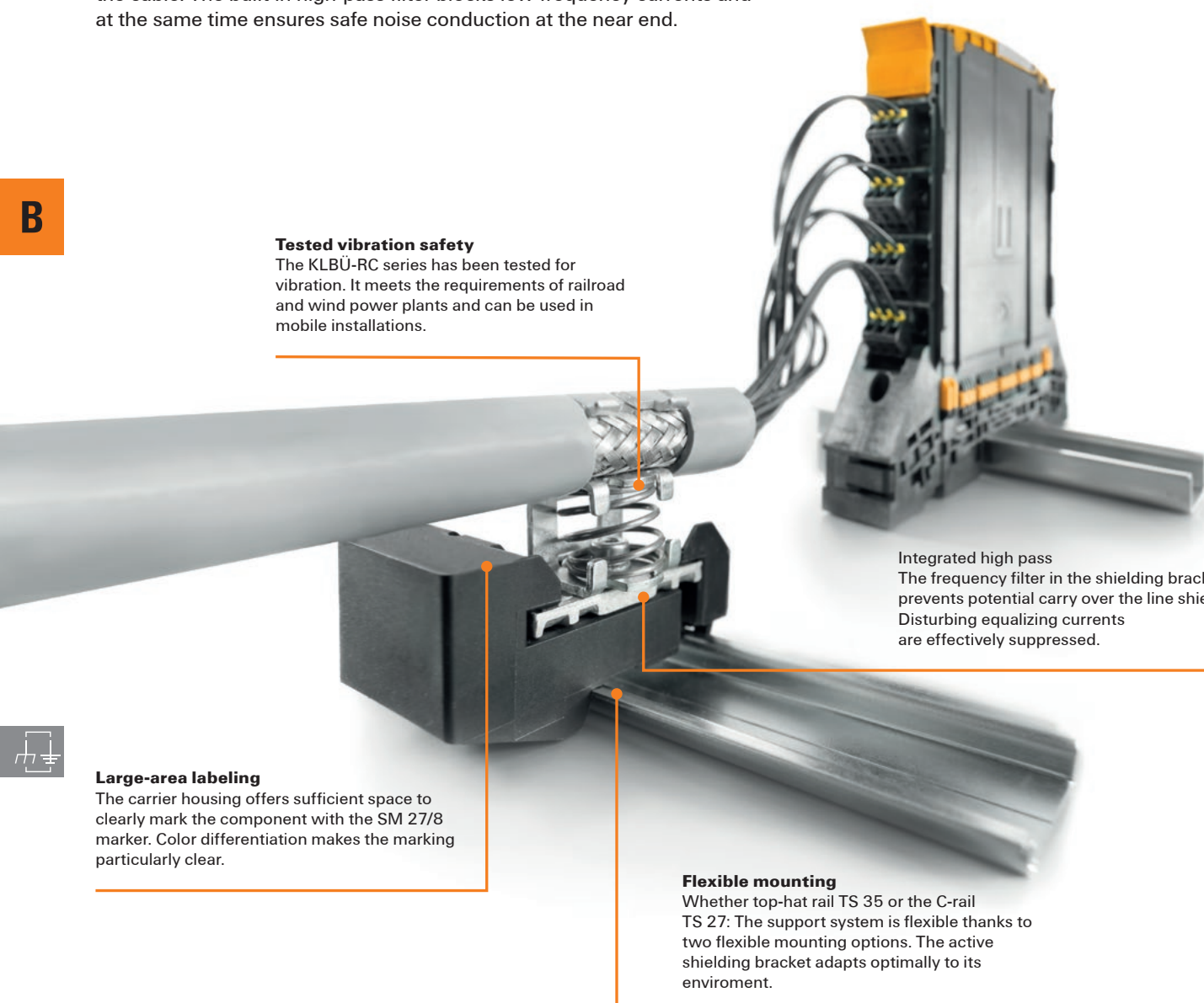

KLBUE 10-20 RC TS 27

Clamping bracket



KLBUE 4-13.5 RC TS 27

Clamping bracket



Width/Height/Depth	mm
--------------------	----

39.6 x 67.5 x 63.6	
--------------------	--

37.5 x 67.5 x 55.6	
--------------------	--

Technical data

Rated data
Rated voltage
Conductors to be clamped:
Cable diameter, min.
Cable diameter, max.
General data
Continuous operating temp., min.
Continuous operating temp., max.
UL 94 flammability rating
Colour
Material
Component 1
Component 2
Installation advice
Note

230 V AC
10 mm
20 mm
-25
105
V-0
black, Silver grey
PA 66 GF 30
Resistance 1 MΩ
Capacitor 100 nF
Direct mounting

230 V AC
4 mm
13.5 mm
-25
105
V-0
black, Silver grey
PA 66 GF 30
Resistance 1 MΩ
Capacitor 100 nF
Direct mounting

Ordering data

Version	for shield connection with high pass
Note	

Type	Qty.	Order No.
KLBUE 10-20 RC TS27	1	1403050000

Type	Qty.	Order No.
KLBUE 4-13.5 RC TS27	1	1403060000

Accessories

Terminal rail	
Marking tags	
Operating tool	
Screwdriver	Standard
C-rail	

Type	Qty.	Order No.
SM 27/8 K MC NE WS	80	1812630000
BTWZ KLBUE	1	1742630000
SDS 0.6X3.5X100	1	2749340000
TS 27X12.5M/ST/F.ZN	2	1802690000

Type	Qty.	Order No.
SM 27/8 K MC NE WS	80	1812630000
BTWZ KLBUE	1	1742630000
SDS 0.6X3.5X100	1	2749340000
TS 27X12.5M/ST/F.ZN	2	1802690000

For detailed information on other accessories and application in the online catalogue



KLBUE 3-8 RC TS 35

Clamping bracket



Width/Height/Depth mm

35 x 67.5 x 50

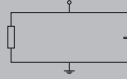

Technical data

Rated data
Rated voltage
Conductors to be clamped:
Cable diameter, min.
Cable diameter, max.
General data
Continuous operating temp., min.
Continuous operating temp., max.
UL 94 flammability rating
Colour
Material
Component 1
Component 2
Installation advice
Note

230 V AC
3 mm
8 mm
-25
105
V-0
black, Silver grey
PA 66 GF 30
Resistance 1 MΩ
Capacitor 100 nF
Direct mounting

Ordering data

Version	for shield connection with high pass
Note	

Type	Qty.	Order No.
KLBUE 3-8 RC TS35	1	1402830000

Accessories

Terminal rail	
Marking tags	
Operating tool	
Screwdriver	Standard
C-rail	

Type	Qty.	Order No.
TS 35X7.5 2M/ST/ZN	2	0383400000
TS 35X7.5/LL 2M/ST/ZN	2	0514500000
TS 35X15/LL 2M/ST/ZN	2	0236500000
SM 27/8 K MC NE WS	80	1812630000
BTWZ KLBUE	1	1742630000
SDS 0.6X3.5X100	1	2749340000

KLBUE 3-8 RC TS 27

Clamping bracket



35 x 67.5 x 50

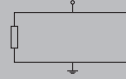

230 V AC
3 mm
8 mm
-25
105
V-0
black, Silver grey
PA 66 GF 30
Resistance 1 MΩ
Capacitor 100 nF
Direct mounting

Type	Qty.	Order No.
KLBUE 3-8 RC TS27	1	1403070000

Type	Qty.	Order No.
SM 27/8 K MC NE WS	80	1812630000
BTWZ KLBUE	1	1742630000
SDS 0.6X3.5X100	1	2749340000
TS 27X12.5M/ST/F.ZN	2	1802690000

For detailed information on other accessories and application in the online catalogue

KLBUE 10-20 RC TS 35

Clamping bracket



KLBUE 4-13.5 RC TS 35

Clamping bracket



Width/Height/Depth mm

39.6 x 67.5 x 63.6

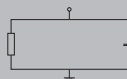

37.5 x 67.5 x 55.6

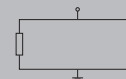

Technical data

Rated data
Rated voltage
Conductors to be clamped:
Cable diameter, min.
Cable diameter, max.
General data
Continuous operating temp., min.
Continuous operating temp., max.
UL 94 flammability rating
Colour
Material
Component 1
Component 2
Installation advice

230 V AC
10 mm
20 mm
-25
105
V-0
black, Silver grey
PA 66 GF 30
Resistance 1 MΩ
Capacitor 100 nF
Direct mounting

230 V AC
4 mm
13.5 mm
-25
105
V-0
black, Silver grey
PA 66 GF 30
Resistance 1 MΩ
Capacitor 100 nF
Direct mounting

Note

Ordering data

Version	for shield connection with high pass
Note	

Type	Qty.	Order No.
KLBUE 10-20 RC TS35	1	1403080000

Type	Qty.	Order No.
KLBUE 4-13.5 RC TS35	1	1403090000

Accessories

Terminal rail	
Marking tags	
Operating tool	
Screwdriver	Standard
C-rail	

Type	Qty.	Order No.
TS 35X7.5 2M/ST/ZN	2	0383400000
TS 35X7.5/LL 2M/ST/ZN	2	0514500000
TS 35X15/LL 2M/ST/ZN	2	0236500000
SM 27/8 K MC NE WS	80	1812630000
BTWZ KLBUE	1	1742630000
SDS 0.6X3.5X100	1	2749340000

Type	Qty.	Order No.
TS 35X7.5 2M/ST/ZN	2	0383400000
TS 35X7.5/LL 2M/ST/ZN	2	0514500000
TS 35X15/LL 2M/ST/ZN	2	0236500000
SM 27/8 K MC NE WS	80	1812630000
BTWZ KLBUE	1	1742630000
SDS 0.6X3.5X100	1	2749340000

For detailed information on other accessories and application in the online catalogue



Equipotential bonding

General principles

Advancements in technology means that, electrical installations in buildings and industrial plants are becoming increasingly extensive and demanding. Furthermore, the application of high-frequency, complex industrial systems grows. In order to guarantee reliability and operational safety, it is necessary to protect machines and systems against overvoltage and electromagnetic coupling. This is achieved by equipotential bonding. The purpose of equipotential bonding is to connect all metallic parts with different potentials to each other so that they have approximately the same potential. In its product portfolio, Weidmüller has developed solutions for equipotential bonding in industrial environments.

B

What is the difference between grounding and Equipotential bonding?

Equipotential bonding

Compensation of different voltages to a uniform level

Grounding

Connection of a point with that of the Earth

functional equipotential bonding

The functional equipotential bonding is used for exclusively functional purposes

protective equipotential bonding

An electrical connection is established between all conductive parts of the system, in order to be connected to the resulting equipotential bonding the human being from an electric shock protect



Innovations in equipotential bonding

In cooperation with Weidmüller, market-leading floor trunking manufacturers have developed a new solution with pre-prepared cut-outs for equipotential bonding. This includes the addition of punchable holes to simplify wiring.

The new small equipotential bonding terminals FB 16-50 offer an efficient solution for fixing conductors of the equipotential bonding to the cable duct. This is particularly interesting for applications where the conductor must be routed through a cable duct over long distances without stubs.



Benefits:

- Simple wiring due to small space requirement
- More cost-effective wiring of the equipotential bonding system
- Use of several product compensation clamps without additional costs
- Possibility of setting up a close-meshed equipotential bonding system
- Achieving low impedance equipotential bonding

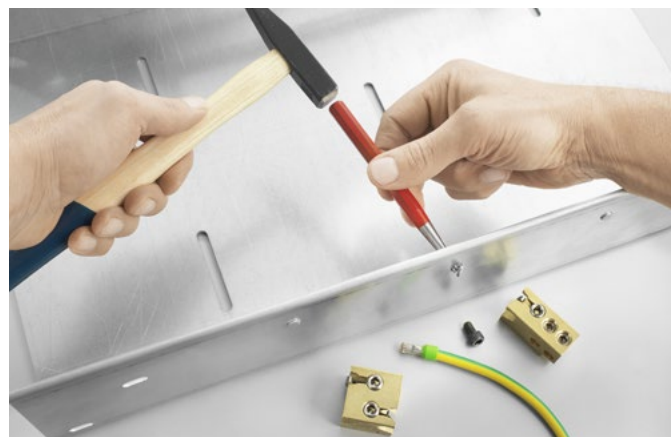

Benefits:

- Easier and more efficient wiring – without drilling
- Punching of holes without special tools
- High flexibility due to small hole spacing of max. 10 cm
- Cleaner working without drilling chips in the floor channel



Shielding and earthing
Potential equalisation terminal block

Potential equalisation terminal block

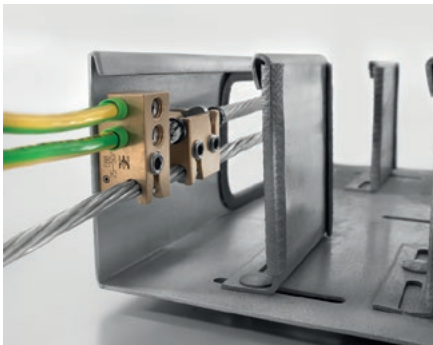

Low installation height

Additional connection up to 16 mm²

Good visibility of the clamping screws

B

Technical data

Connection direction	on side
Tightening torque, min.	5 Nm
Clamping screw	M 6
Connection cross-section, flexible, min. / max.	10...50 mm ²

Note

Ordering data

Type	Stripping length	Number of connections	Conductor min. / max.	Qty.	Order No.
Screw connection					
JB 25-50	33	2	10...50	10	1547500000
JB 25-50 TH	33	2	10...50	10	2762660000
EBB 25-50/16	20	3	10...50	10	1547490000
EBB 25-50/16 AM	20	3	10...50	10	2756940000
FB 16-50	33	1	16...50	15	2623930000

Type	Description of article	Qty.	Order No.
SK WSD-S 1,5-10,0	Screwing tool	1	9008850000

Note



Practical tip

Functional earth terminal blocks

According to the Machinery Directive 2006/42EG, terminal blocks may be white when used for functional earthing. PE terminals with a protective function for life and limb must still be green-yellow, but can also be used for functional earthing. The symbols used are extended in order to clarify the use as a functional earth.

Weidmüller offers white PE terminals from the "A-, W- and Z series" product family for systems in which this distinction should or must be made. The colour of these terminals clearly indicates that the respective circuits are exclusively to provide functional protection for the connected electronic system.

Symbol for functional earth:



Symbol for protection earth:



A-Series
with PUSH IN technology



Type	Qty.	Order No.
A2C 2.5 FE WT	50	2690460000
A4C 2.5 FE WT	50	2690470000
A2C 4 FE WT	50	2734150000
A2C 6 FE WT	50	2734160000
A2C 10 FE WT	50	2734170000



Z-Series
with tension spring technology

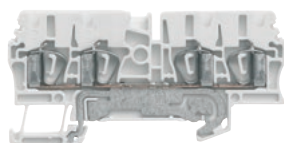

Type	Qty.	Order No.
ZPE 2.5/4AN WS	50	1698110000



W-Series
with clamping-yoke technology

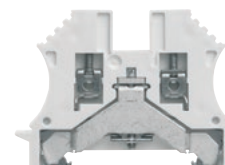

Type	Qty.	Order No.
WPE 2.5 WS	100	1010010000

B



Shielding and earthing
Functional earth – PUSH IN connection



A2C 2.5 FE WT

2.5 mm²



A4C 2.5 FE WT

2.5 mm²



Width/Height/Depth	mm
max. current / max. cond. cross-section	-/mm ²
Max. clamping range	mm ²

5.1 x 55 x 36.5	/ 4	
0.14...4		

5.1 x 77.5 x 36.5	/ 4	
0.14...4		

Technical data

Rated data	
Rated voltage	-
Rated current	-
for wire cross-section	mm ²
Rated impulse withstand voltage / Pollution severity	
Gauge to IEC 60947-1 / UL 94 flammability rating	
Approvals	
Clamped conductors (H05V/H07V)	
Solid / Stranded	mm ²
Flexible / Flexible with ferrule	mm ²
Twin wire-end ferrule	mm ²
Stripping length / Blade size	mm/-

IEC 60947-7-2			
IEC	UL	CSA	EN 60079-7
	600	600	
2.5	AWG 28...12	AWG 28...12	2.5 mm ²
/ 3			
A3 / V-0			
Rated connection			
0.5...2.5 / 0.5...4			
0.5...4 / 0.5...2.5			
0.5...0.75			
10 / 0.6 x 3.5 mm			

IEC 60947-7-2			
IEC	UL	CSA	EN 60079-7
	600	600	
2.5	AWG 28...12	AWG 28...12	2.5 mm ²
/ 3			
A3 / V-0			
Rated connection			
0.5...2.5 / 0.5...4			
0.5...4 / 0.5...2.5			
0.5...0.75			
10 / 0.6 x 3.5 mm			

Note

Ordering data

Version	white
Note	

Type	Qty.	Order No.
A2C 2.5 FE WT	50	2690460000

Type	Qty.	Order No.
A4C 2.5 FE WT	50	2690470000

Accessories

End plate	dark beige
End bracket	dark beige, screwable dark beige, direct mounting
Test adapter	1-pole stackable 3-pole 5-pole
Test plug	
Screwdriver	Standard
Marking tags	

Type	Qty.	Order No.
AEP 2C 2.5	50	1514400000
AEB 35 SC/1	50	1991920000
AEB 35 SCL/1 V0	20	2661280000
ATPG 1.5-10 L	0.2 A 50	1991890000
ATPG 2.5 MHR	0.2 A 50	1991960000
ATPG 2.5/3	0.2 A 25	2041190000
ATPG 2.5/5	0.2 A 25	2041180000
PS 2.0 MC	20	0310000000
SDIL 0,6X3,5X100	1	2749140000
DEK 5/5 PLUS MC NE WS	1000	1854490000
DEK 5/5 MM WS	800	2007110000
WS 8/5 MM WS	800	2007150000
WS 10/5 M PLUS MC NE WS	600	2003770000

Type	Qty.	Order No.
AEP 2C 2.5	50	1514400000
AEB 35 SC/1	50	1991920000
AEB 35 SCL/1 V0	20	2661280000
ATPG 1.5-10 L	0.2 A 50	1991890000
ATPG 2.5 MHR	0.2 A 50	1991960000
ATPG 2.5/3	0.2 A 25	2041190000
ATPG 2.5/5	0.2 A 25	2041180000
PS 2.0 MC	20	0310000000
SDIL 0,6X3,5X100	1	2749140000
DEK 5/5 PLUS MC NE WS	1000	1854490000
DEK 5/5 MM WS	800	2007110000
WS 8/5 MM WS	800	2007150000
WS 10/5 M PLUS MC NE WS	600	2003770000

For detailed information on other accessories and application in the online catalogue

A2C 4 FE WT

4 mm²

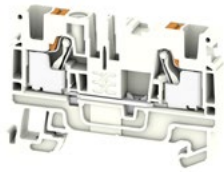

6.1 x 60 x 39.5
/ 6
0.14...6



IEC 60947-7-2

IEC	UL	CSA	EN 60079-7
4			
	8 kV / 3		
	A4 / V-0		

CE

Rated connection

0.5...4 / 0.5...6

0.5...6 / 0.5...4

0.5...1.5

12 / 0.6 x 3.5 mm

A2C 6 FE WT

6 mm²



8.1 x 66.5 x 45.5
/ 10
0.34...10



IEC 60947-7-2

IEC	UL	CSA	EN 60079-7
6			
	8 kV / 3		
	A5 / V-0		

CE

Rated connection

0.5...6 / 0.5...6

0.5...10 / 0.5...6

0.5...1.5

12 / 0.6 x 3.5 mm

A2C 10 FE WT

10 mm²



10 x 80.5 x 51.5
/ 16
0.5...16



IEC 60947-7-2

IEC	UL	CSA	EN 60079-7
10			
	/ 3		
	A6 / V-0		

CE

Rated connection

0.5...10 / 0.5...10

0.5...10 / 0.5...10

0.5...4

18 / 0.6 x 3.5 mm

Type	Qty.	Order No.
A2C 4 FE WT	50	2734150000

Type	Qty.	Order No.
A2C 6 FE WT	50	2734160000

Type	Qty.	Order No.
A2C 10 FE WT	50	2734170000

Type	Qty.	Order No.	
AEP 2C 4	50	2051680000	
AEB 35 SC/1	50	1991920000	
AEB 35 SCL/1 V0	20	2661280000	
ATPG 1.5-10 L	0.2 A	50	1991890000
ATPG 4 M-R	0.2 A	50	1991860000
PS 2.0 MC	20	0310000000	
SDIL 0,6X3,5X100	1	2749140000	
WS 10/6 M PLUS MC NE WS	600	2003780000	
DEK 5/6 MM WS	600	2007120000	
WS 8/6 MM WS	600	2007160000	
DEK 5/6 PLUS MC NE WS	1000	1011320000	

Type	Qty.	Order No.	
AEP 2C 6	50	1991970000	
AEB 35 SC/1	50	1991920000	
AEB 35 SCL/1 V0	20	2661280000	
ATPG 1.5-10 L	0.2 A	50	1991890000
ATPG 6 M-R	0.2 A	50	1991930000
PS 2.0 MC	20	0310000000	
SDIL 1,0X5,5X125	1	2749160000	
DEK-A 5/8 MM WS	500	2448860000	
DEK 5/8 PLUS MC NE WS	800	1046350000	
WS-A 8/8 MM WS	500	2448930000	
WS 10/8 PLUS MC NE WS	420	1905950000	

Type	Qty.	Order No.	
AEP 2C 10/16	20	2490380000	
AEB 35 SC/1	50	1991920000	
AEB 35 SCL/1 V0	20	2661280000	
ATPG 1.5-10 L	0.2 A	50	1991890000
PS 2.0 MC	20	0310000000	
SDIL 1,0X5,5X125	1	2749160000	
DEK 5/5 PLUS MC NE WS	1000	1854490000	
DEK 5/8 PLUS MC NE WS	800	1046350000	
WS 10/8 PLUS MC NE WS	420	1905950000	

Shielding and earthing
Functional earth – Tension clamp connection

ZPE 2.5/4AN WS

2.5 mm²



Width/Height/Depth	mm
max. current / max. cond. cross-section	-/mm ²
Max. clamping range	mm ²

5.1 x 79.5 x 38.5
/ 4
0.05...4

Technical data

Rated data	
Rated voltage	-
Rated current	-
for wire cross-section	mm ²
Rated impulse withstand voltage / Pollution severity	
Gauge to IEC 60947-1 / UL 94 flammability rating	
Approvals	
Clamped conductors (H05V/H07V)	
Solid / Stranded	mm ²
Flexible / Flexible with ferrule	mm ²
Twin wire-end ferrule	-
Stripping length / Blade size	mm/-

IEC	UL	CSA	EN 60079-7
2.5			
	/ 3		
	A3 / V-0		
CE			
Rated connection			
0.5...4			
0.5...4 / 0.5...2.5			
10 / 0.6 x 3.5 mm			

Note

Ordering data

Version	white
Note	

Type	Qty.	Order No.
ZPE 2.5/4AN WS	50	1698110000

Accessories

End bracket	dark beige
Test adapter	With spigot
Reducing sleeves	for conductors < 0.5 mm ² / AWG 20 for conductors < 1.0 mm ² / AWG 18
Marking tags	
Screwdriver	Standard

Type	Qty.	Order No.
ZEW 35	20	9540000000
ZTA 1/ZA	9 A 25	1609050000
ZRH 2.5/1 WS	1000	1614300000
ZRH 2.5/2 GR/V0	1000	1614290000
BZT 1 WS 10/5	100	1805490000
BZT 1 ZA WS 10/5	100	1805520000
SDIS SLIM 0.6X3.5X100	1	2749610000

For detailed information on other accessories and application in the online catalogue





WPE 2.5 WS

2.5 mm²

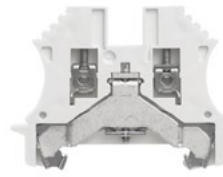

Width/Height/Depth	mm
max. current / max. cond. cross-section	-/mm ²
Max. clamping range	mm ²

5.1 x 60 x 46.5
/ 4
0.05...4



Technical data

Rated data	
Rated voltage	-
Rated current	-
for wire cross-section	mm ²
Rated impulse withstand voltage / Pollution severity	
Gauge to IEC 60947-1 / UL 94 flammability rating	
Approvals	
Clamped conductors (H05V/H07V)	
Solid / Stranded	mm ²
Flexible / Flexible with ferrule	mm ²
Twin wire-end ferrule	-
Stripping length / Blade size	mm/-

IEC	UL	CSA	EN 60079-7
2.5			
	/ 3		
	A3 / V-0		
CE			
Rated connection			
0.5...4 / 1.5...4			
0.5...4 / 0.5...2.5			
10 / 0.6 x 3.5 mm			

Note

Ordering data

Version	white
Note	

Type	Qty.	Order No.
WPE 2.5 WS	50	1010010000

Accessories

End plate / Partition plate	dark beige
End bracket	dark beige
Screwdriver	Standard
Marking tags	

Type	Qty.	Order No.
WAP 2.5-10	50	1050000000
WEW 35/2	50	1061200000
SDS 0.6X3.5X100	1	2749340000
DEK 5/5 MC NE WS	1000	1609801044
WS 12/5 MC NE WS	720	1609860000

For detailed information on other accessories and application in the online catalogue

B



Shielding and earthing
Functional earth – PUSH IN connection



AL2C 2.5 FE

2.5 mm²



AL3C 2.5 FE

2.5 mm²

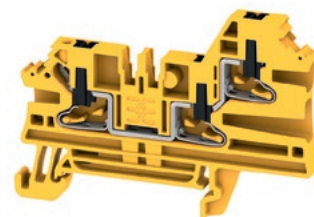

Width/Height/Depth	mm
max. current / max. cond. cross-section	A/mm ²
Max. clamping range	mm ²

5.1 x 57 x 36.5
24 / 2.5
0.14...2.5

5.1 x 68 x 48
24 / 2.5
0.14...2.5

Technical data

Rated data	
Rated voltage	V
Rated current	A
for wire cross-section	mm ²
Rated impulse withstand voltage / Pollution severity	
Gauge to IEC 60947-1 / UL 94 flammability rating	
Approvals	
Clamped conductors (H05V/H07V)	
Solid / Stranded	mm ²
Flexible / Flexible with ferrule	mm ²
Twin wire-end ferrule	mm ²
Stripping length / Blade size	mm/-

IEC 60947-7-1			
IEC	UL	CSA	EN 60079-7
800			
24			
2.5			
	8 kV / 3		
	A3 / V-0		
Rated connection			
0.5...2.5 / 0.5...2.5			
0.5...2.5 / 0.5...2.5			
0.5...0.75			
10 / 0.6 x 3.5 mm			

IEC 60947-7-1			
IEC	UL	CSA	EN 60079-7
800			
24			
2.5			
	8 kV / 3		
	A3 / V-0		
Rated connection			
0.5...2.5 / 0.5...2.5			
0.5...2.5 / 0.5...2.5			
0.5...0.75			
10 / 0.6 x 3.5 mm			

Note

Ordering data

Version	
	yellow/black
Note	

Type	Qty.	Order No.
AL2C 2.5 FE	50	2847320000

Type	Qty.	Order No.
AL3C 2.5 FE	50	2847450000

Accessories

Plug-in cross-connection	
	2-pole
	10-pole
	2-pole
	10-pole
End plate	
	dark beige
	Blue
End bracket	
	dark beige, screwable
	dark beige, direct mounting
Test adapter	
	1-pole
	stackable
	3-pole
	5-pole
Test plug	
Screwdriver	
	Standard
Marking tags	

Type	Qty.	Order No.
ZQV 2.5N/2	24 A 60	1527540000
ZQV 2.5N/10	24 A 20	1527690000
ALEP 2C 2.5	20	2871750000
ALEP 2C 2.5 BL	20	2871760000
AEB 35 SC/1	50	1991920000
AEB 35 SCL/1 VO	20	2661280000
ATPG 1.5-10 L	0.2 A 50	1991890000
ATPG 2.5 MHR	0.2 A 50	1991960000
ATPG 2.5/3	0.2 A 25	2041190000
ATPG 2.5/5	0.2 A 25	2041180000
PS 2.0 MC	20	0310000000
SDIL 0,6X3,5X100	1	2749140000
DEK 5/5 PLUS MC NE WS	1000	1854490000
DEK 5/5 MM WS	800	2007110000
WS 8/5 MM WS	800	2007150000
WS 10/5 M PLUS MC NE WS	600	2003770000

Type	Qty.	Order No.
ZQV 2.5N/2	24 A 60	1527540000
ZQV 2.5N/10	24 A 20	1527690000
ALEP 3C 2.5	20	2871770000
ALEP 3C 2.5 BL	20	2871780000
AEB 35 SC/1	50	1991920000
AEB 35 SCL/1 VO	20	2661280000
ATPG 1.5-10 L	0.2 A 50	1991890000
ATPG 2.5 MHR	0.2 A 50	1991960000
ATPG 2.5/3	0.2 A 25	2041190000
ATPG 2.5/5	0.2 A 25	2041180000
PS 2.0 MC	20	0310000000
SDIL 0,6X3,5X100	1	2749140000
DEK 5/5 PLUS MC NE WS	1000	1854490000
DEK 5/5 MM WS	800	2007110000
WS 8/5 MM WS	800	2007150000
WS 10/5 M PLUS MC NE WS	600	2003770000

For detailed information on other accessories and application in the online catalogue

AL4C 2.5 FE

2.5 mm²

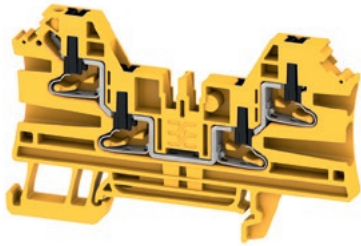

5.1 x 79.5 x 48
24 / 2.5
0.14...2.5

IEC 60947-7-1

IEC	UL	CSA	EN 60079-7
800			
24			
2.5			
8 kV / 3			
A3 / V-0			

Rated connection

0.5...2.5 / 0.5...2.5
0.5...2.5 / 0.5...2.5
0.5...0.75
10 / 0.6 x 3.5 mm

Type	Qty.	Order No.
AL4C 2.5 FE	50	2847580000

Type	Qty.	Order No.
ZQV 2.5N/2	24 A 60	1527540000
ZQV 2.5N/10	24 A 20	1527690000

ALEP 4C 2.5	20	2871790000
ALEP 4C 2.5 BL	20	2871800000

AEB 35 SC/1	50	1991920000
AEB 35 SCL/1 VO	20	2661280000

ATPG 1.5-10 L	0.2 A 50	1991890000
ATPG 2.5 MI-R	0.2 A 50	1991960000
ATPG 2.5/3	0.2 A 25	2041190000
ATPG 2.5/5	0.2 A 25	2041180000

PS 2.0 MC	20	0310000000
-----------	----	------------

SDIL 0,6X3,5X100	1	2749140000
------------------	---	------------

DEK 5/5 PLUS MC NE WS	1000	1854490000
DEK 5/5 MM WS	800	2007110000
WS 8/5 MM WS	800	2007150000
WS 10/5 M PLUS MC NE WS	600	2003770000

AL2C 4 FE

4 mm²

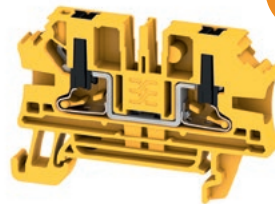

Q3
2023

6.1 x 60 x 39.5
32 / 4
0.14...4

IEC 60947-7-1

IEC	UL	CSA	EN 60079-7
1000			
32			
4			
8 kV / 3			
A4 / V-0			

Rated connection

0.5...4 / 0.5...4
0.5...4 / 0.5...4
0.5...1.5
12 / 0.6 x 3.5 mm

Type	Qty.	Order No.
AL2C 4 FE		2871980000

Type	Qty.	Order No.
ZQV 4N/2	32 A 60	1527930000
ZQV 4N/10	32 A 20	1528090000

ALEP 2C 4		2871810000
ALEP 2C 4 BL		2871820000

AEB 35 SC/1	50	1991920000
AEB 35 SCL/1 VO	20	2661280000

ATPG 1.5-10 L	0.2 A 50	1991890000
ATPG 4 MHR	0.2 A 50	1991860000

PS 2.0 MC	20	0310000000
-----------	----	------------

SDIL 0,6X3,5X100	1	2749140000
------------------	---	------------

WS 10/6 M PLUS MC NE WS	600	2003780000
DEK 5/6 MM WS	600	2007120000
WS 8/6 MM WS	600	2007160000
DEK 5/6 PLUS MC NE WS	1000	1011320000

AL3C 4 FE

4 mm²



Q3
2023

6.1 x 71.5 x 52.5
32 / 4
0.14...4

IEC 60947-7-1

IEC	UL	CSA	EN 60079-7
1000			
32			
4			
8 kV / 3			
A4 / V-0			

Rated connection

0.5...4 / 0.5...4
0.5...4 / 0.5...4
0.5...1.5
12 / 0.6 x 3.5 mm

Type	Qty.	Order No.
AL3C 4 FE		2872100000

Type	Qty.	Order No.
ZQV 4N/2	32 A 60	1527930000
ZQV 4N/10	32 A 20	1528090000

ALEP 3C 4		2871830000
ALEP 3C 4 BL		2871840000

AEB 35 SC/1	50	1991920000
AEB 35 SCL/1 VO	20	2661280000

ATPG 1.5-10 L	0.2 A 50	1991890000
ATPG 4 MHR	0.2 A 50	1991860000

PS 2.0 MC	20	0310000000
-----------	----	------------

SDIL 0,6X3,5X100	1	2749140000
------------------	---	------------

WS 10/6 M PLUS MC NE WS	600	2003780000
DEK 5/6 MM WS	600	2007120000
WS 8/6 MM WS	600	2007160000
DEK 5/6 PLUS MC NE WS	1000	1011320000



Shielding and earthing
Functional earth – PUSH IN connection

AL4C 4 FE

4 mm²

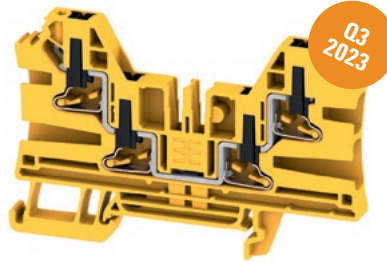

A4C 6 FE

6 mm²

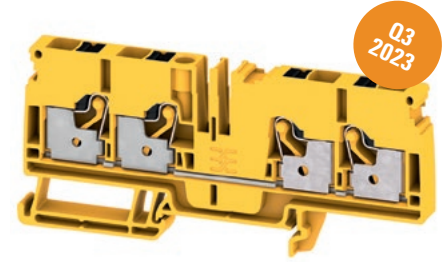

Width/Height/Depth	mm
max. current / max. cond. cross-section	A/mm ²
Max. clamping range	mm ²

6.1 x 83 x 52.5
32 / 4
0.14...4

8.1 x 102 x 45.5
41 / 10
0.34...10

Technical data

Rated data	
Rated voltage	V
Rated current	A
for wire cross-section	mm ²
Rated impulse withstand voltage / Pollution severity	
Gauge to IEC 60947-1 / UL 94 flammability rating	
Approvals	
Clamped conductors (H05V/H07V)	
Solid / Stranded	mm ²
Flexible / Flexible with ferrule	mm ²
Twin wire-end ferrule	mm ²
Stripping length / Blade size	mm/-

IEC 60947-7-1			
IEC	UL	CSA	EN 60079-7
1000			
32			
4			
		8 kV / 3	
		A4 / V-0	
Rated connection			
0.5...4 / 0.5...4			
0.5...4 / 0.5...4			
0.5...1.5			
12 / 0.6 x 3.5 mm			

IEC 60947-7-1			
IEC	UL	CSA	EN 60079-7
800			
41			
6			
		8 kV / 3	
		A5 / V-0	
Rated connection			
0.5...6 / 0.5...6			
0.5...10 / 0.5...6			
0.5...1.5			
12 / 1.0 x 5.5 mm			

Note

Ordering data

Version	
	yellow/black
Note	

Type	Qty.	Order No.
AL4C 4 FE		2872220000

Type	Qty.	Order No.
A4C 6 FE		2881480000

Accessories

Plug-in cross-connection	
	2-pole
	3-pole
	4-pole
	2-pole
	10-pole
End plate	
	dark beige
	Blue
End bracket	
	dark beige, screwable
	dark beige, direct mounting
Test adapter	
	1-pole
	stackable
Test plug	
Screwdriver	
	Standard
Marking tags	

Type	Qty.	Order No.
ALEP 4C 4		2871850000
ALEP 4C 4 BL		2871860000
AEB 35 SC/1	50	1991920000
AEB 35 SCL/1 V0	20	2661280000
ATPG 1.5-10 L	0.2 A 50	1991890000
ATPG 4 M-R	0.2 A 50	1991860000
PS 2.0 MC	20	0310000000
SDIL 0,6X3,5X100	1	2749140000
WS 10/6 M PLUS MC NE WS	600	2003780000
WS 8/6 MM WS	600	2007160000
DEK 5/6 MM WS	600	2007120000
DEK 5/6 PLUS MC NE WS	1000	1011320000

Type	Qty.	Order No.
ZQV 6N/2	41 A 60	1985740000
ZQV 6N/3	41 A 60	1985760000
ZQV 6N/4	41 A 60	1985780000
AEP 4C 6		2876180000
AEP 4C 6 BL		2876190000
AEB 35 SC/1	50	1991920000
AEB 35 SCL/1 V0	20	2661280000
ATPG 1.5-10 L	0.2 A 50	1991890000
ATPG 6 M-R	0.2 A 50	1991930000
PS 2.0 MC	20	0310000000
SDIL 1,0X5,5X125	1	2749160000
DEK-A 5/8 MM WS	500	2448860000
WS-A 8/8 MM WS	500	2448930000
DEK 5/8 PLUS MC NE WS	800	1046350000
WS 10/8 PLUS MC NE WS	420	1905950000

For detailed information on other accessories and application in the online catalogue

A2C 35 FE

35 mm²

A2C 35 DM

35 mm²



Width/Height/Depth	mm
max. current / max. cond. cross-section	A/mm ²
Max. clamping range	mm ²

16 x 101.5 x 71.5
125 / 35
2.5...35

16 x 135 x 71.5
125 / 35
2.5...35

Technical data

Rated data	
Rated voltage	V
Rated current	A
for wire cross-section	mm ²
Rated impulse withstand voltage / Pollution severity	
Gauge to IEC 60947-1 / UL 94 flammability rating	
Approvals	
Clamped conductors (H05V/H07V)	
Solid / Stranded	mm ²
Flexible / Flexible with ferrule	mm ²
Twin wire-end ferrule	mm ²
Stripping length / Blade size	mm/-

IEC 60947-7-1

IEC	UL	CSA	EN 60079-7
1000	1000		880
125			105
35	AWG 12...2	AWG 12...2	35 mm ²
8 kV / 3			
/ V-0			



Rated connection

2.5...16 / 10...35
10...35 / 2.5...35
2.5...10
25 / 1.0 x 5.5 mm

IEC 60947-7-1

IEC	UL	CSA	EN 60079-7
1000	1000		880
125			105
35	AWG 12...2	AWG 12...2	35 mm ²
8 kV / 3			
/ V-0			



Rated connection

2.5...16 / 10...35
10...35 / 2.5...35
2.5...10
25 / 1.0 x 5.5 mm

Note

Ordering data

Version
yellow/black

Note

Type	Qty.	Order No.
A2C 35 FE	10	2551530000

Type	Qty.	Order No.
A2C 35 FE DM	10	2552160000

Accessories

Plug-in cross-connection	2-pole
	2-pole
	2-pole
End bracket	dark beige, screwable
	dark beige, direct mounting
Test adapter	1-pole
Test plug	
Screwdriver	Standard
Warning labels	
Marking tags	

Type	Qty.	Order No.
ZQV 35N/2	125 A 10	2634950000
ZQV 35N-10	57 A 10	2562670000
ZQV 35N-16	76 A 10	2562660000
AEB 35 SC/1	50	1991920000
AEB 35 SCL/1 V0	20	2661280000
ATPG 1.5-10 L	0.2 A 50	1991890000
PS 2.0 MC	20	0310000000
SDS 1.0X5.5X150	1	2749380000
AAM 35-185 YE FLASH	40	2635600000
WS-A 8/16 MM WS	200	2619910000

Type	Qty.	Order No.
ZQV 35N/2	125 A 10	2634950000
ZQV 35N-10	57 A 10	2562670000
ZQV 35N-16	76 A 10	2562660000
AEB 35 SC/1	50	1991920000
AEB 35 SCL/1 V0	20	2661280000
ATPG 1.5-10 L	0.2 A 50	1991890000
PS 2.0 MC	20	0310000000
SDS 1.0X5.5X150	1	2749380000
AAM 35-185 YE FLASH	40	2635600000
WS-A 8/16 MM WS	200	2619910000

For detailed information on other accessories and application in the online catalogue



Shielding and earthing
Functional earth – PUSH IN connection

A2C 50/70 FE

50 mm²

A2C 50/70 FE-DM

50 mm²

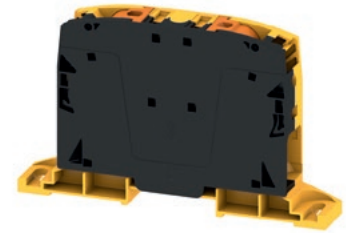
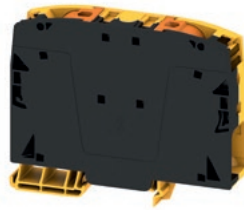

Width/Height/Depth	mm
max. current / max. cond. cross-section	A/mm ²
Max. clamping range	mm ²

20 x 101.5 x 80.5
150 / 70
10...70

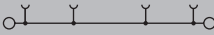

20 x 134 x 80.5
150 / 70
10...70

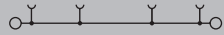

Technical data

Rated data	
Rated voltage	V
Rated current	A
for wire cross-section	mm ²
Rated impulse withstand voltage / Pollution severity	
Gauge to IEC 60947-1 / UL 94 flammability rating	
Approvals	
Clamped conductors (H05V/H07V)	
Solid / Stranded	mm ²
Flexible / Flexible with ferrule	mm ²
Twin wire-end ferrule	mm ²
Stripping length / Blade size	mm/-

IEC 60947-7-1

IEC	UL	CSA	EN 60079-7
1000	1000	1000	
150			
50	AWG 8...0	AWG 8...NaN	
8 kV / 3			
/ V-0			

CE, UL, CSA, EN 60079-7

Rated connection	
10...16 / 10...70	
10...70 / 10...50	
4...10	
30 / 1.0 x 5.5 mm	

IEC 60947-7-1

IEC	UL	CSA	EN 60079-7
1000	1000	1000	
150			
50	AWG 8...0	AWG 8...NaN	
8 kV / 3			
/ V-0			

CE, UL, CSA, EN 60079-7

Rated connection	
10...16 / 10...70	
10...70 / 10...50	
4...10	
30 / 1.0 x 5.5 mm	

Note

If a cross-connection is mounted next to a PE terminal block or a terminal block for direct mounting, the rated voltage is reduced to 1000 V DC.

If a cross-connection is mounted next to a PE terminal block or a terminal block for direct mounting, the rated voltage is reduced to 1000 V DC.

Ordering data

Version	yellow/black
Note	

Type	Qty.	Order No.
A2C 50/70 FE	5	2663270000

Type	Qty.	Order No.
A2C 50/70 FE-DM	5	2663350000

Accessories

Cross connections insertable	
	2-pole
	3-pole
End bracket	
	dark beige, screwable
	dark beige, direct mounting
Test adapter	
	1-pole
Test plug	
Screwdriver	
	Standard
Warning labels	
Marking tags	

Type	Qty.	Order No.
ZQV 50/70N/2	150 A 10	2663400000
AEB 35 SC/1	50	1991920000
AEB 35 SCL/1 VO	20	2661280000
ATPG 1.5-10 L	0.2 A 50	1991890000
PS 2.0 MC	20	0310000000
SDS 1.0X5.5X150	1	2749380000
AAM 35-185 YE FLASH	40	2635600000
WS-A 8/16 MM WS	200	2619910000

Type	Qty.	Order No.
ZQV 50/70N/2	150 A 10	2663400000
AEB 35 SC/1	50	1991920000
AEB 35 SCL/1 VO	20	2661280000
ATPG 1.5-10 L	0.2 A 50	1991890000
PS 2.0 MC	20	0310000000
SDS 1.0X5.5X150	1	2749380000
AAM 35-185 YE FLASH	40	2635600000
WS-A 8/16 MM WS	200	2619910000

For detailed information on other accessories and application in the online catalogue

A2C 95/120 FE

95 mm²



25 x 101.5 x 90
232 / 120
25...120



IEC 60947-7-1

IEC	UL	CSA	EN 60079-7
1000			
232			
95	AWG 4...0		
8 kV / 3 / V0			



Rated connection

25...120 / 25...120
25...120 / 25...95

40 / 1.0 x 5.5 mm

If a cross-connection is mounted next to a PE terminal block or a terminal block for direct mounting, the rated voltage is reduced to 1000 V DC.

Type	Qty.	Order No.
A2C 95/120 FE	5	2694080000

Type	Qty.	Order No.	
ZQV 95/120N/2	192 A	10	2694250000
ZQV 95/120N/3	192 A	10	2694260000
AEB 35 SC/1	50	1991920000	
AEB 35 SCL/1 V0	20	2661280000	
ATPG 1.5-10 L	0.2 A	50	1991890000
PS 2.0 MC	20	0310000000	
SDS 1.0X5.5X150	1	2749380000	
AAM 35-185 YE FLASH	40	2635600000	
WS-A 8/16 MM WS	200	2619910000	

A2C 95/120 FE-DM

95 mm²

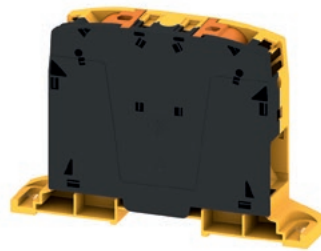

25 x 133.5 x 90
232 / 120
25...120



IEC 60947-7-1

IEC	UL	CSA	EN 60079-7
1000			
232			
95	AWG 4...0		
8 kV / 3 / V0			



Rated connection

25...120 / 25...120
25...120 / 25...95

40 / 1.0 x 5.5 mm

If a cross-connection is mounted next to a PE terminal block or a terminal block for direct mounting, the rated voltage is reduced to 1000 V DC.

Type	Qty.	Order No.
A2C 95/120 FE-DM	5	2694170000

Type	Qty.	Order No.	
ZQV 95/120N/2	192 A	10	2694250000
ZQV 95/120N/3	192 A	10	2694260000
ATPG 1.5-10 L	0.2 A	50	1991890000
PS 2.0 MC	20	0310000000	
SDS 1.0X5.5X150	1	2749380000	
AAM 35-185 YE FLASH	40	2635600000	
WS-A 8/16 MM WS	200	2619910000	

A2C 150/185 FE

150 mm²



Q3
2023

34 x 118.5 x 98
309 / 185
25...185



IEC 60947-7-1

IEC	UL	CSA	EN 60079-7
1000			
309			
150			
8 kV / 3 / V0			



Rated connection

50...185 / 50...185
50...185 / 50...150

40 / 1.0 x 5.5 mm

If a cross-connection is mounted next to a PE terminal block or a terminal block for direct mounting, the rated voltage is reduced to 1000 V DC.

Type	Qty.	Order No.
A2C 150/185 FE	5	2728720000

Type	Qty.	Order No.	
ZQV 150/185N/2	232 A	5	2728840000
ZQV 150/185N/3	232 A	5	2728850000
AEB 35 SC/1	50	1991920000	
AEB 35 SCL/1 V0	20	2661280000	
ATPG 1.5-10 L	0.2 A	50	1991890000
PS 2.0 MC	20	0310000000	
SDS 1.0X5.5X150	1	2749380000	
AAM 35-185 YE FLASH	40	2635600000	
WS-A 8/16 MM WS	200	2619910000	



Shielding and earthing
Functional earth – Screw connection



WDU 2.5

2.5 mm²

WDU 4

4 mm²

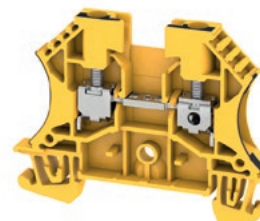
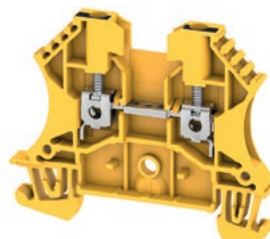

Width/Height/Depth	mm
max. current / max. cond. cross-section	A/mm ²
Max. clamping range	mm ²

5.1 x 60 x 46.5	
32 / 4	
0.05...4	

6.1 x 60 x 46.5	
41 / 6	
0.13...6	

Technical data

Rated data	
Rated voltage	V
Rated current	A
for wire cross-section	mm ²
Rated impulse withstand voltage / Pollution severity	
Gauge to IEC 60947-1 / UL 94 flammability rating	
Approvals	
Clamped conductors (H05V/H07V)	
Solid / Stranded	mm ²
Flexible / Flexible with ferrule	mm ²
Tightening torque / Clamping screw	Nm
Stripping length / Blade size	mm/-
2 conductors with same cross-section (H05V/H07V)	
Solid / Stranded	mm ²
Flexible / Flexible with ferrule	mm ²
Note	

IEC 60947-1	Ex eb II C Gb		II 2 G D
IEC	UL	CSA	EN 60079-7
800			
24			
2.5			
	8 kV / 3		
	A3 / V-0		
Rated connection	Further connection		
0.5...4 / 1.5...4			
0.5...4 / 0.5...2.5			
0.4...0.8 / (M 2.5)			
10 / 0.6 x 3.5 mm			
0.5...1.5			
0.5...1.5 / 0.5...1.5			

IEC 60947-1	Ex eb II C Gb		II 2 G D
IEC	UL	CSA	EN 60079-7
800			690
32			32
4			4 mm ²
	8 kV / 3		
	A4 / V-0		
	DEMKO14ATEX1338U		
Rated connection	Further connection		
0.5...6 / 1.5...6			
0.5...6 / 0.5...4			
0.5...1 / (M 3)			
10 / 0.6 x 3.5 mm			
0.5...1.5 / 0.5...1.5			

Ordering data

Version	
	yellow/black
Note	

Type	Qty.	Order No.
WDU 2.5 GE/SW	100	2429520000

Type	Qty.	Order No.
WDU 4 GE/SW	100	1020190000

Accessories

Plug-in cross-connection	
	2-pole
	10-pole
	2-pole
	10-pole
Screwable cross-connection	
	2-pole
	10-pole
End plate / Partition plate	
	dark beige
	Blue
	dark beige
	Blue
End bracket	
	dark beige
Testing / Checking	
	Standard
	With spigot
Cover	
	Blank, yellow
	Blank, white
Marking tags	

Type	Qty.	Order No.
ZQV 2.5N/2	24 A 60	1527540000
ZQV 2.5N/10	24 A 20	1527690000
WQV 2.5/2	32 A 50	1053660000
WQV 2.5/10	32 A 20	1054460000
WAP 2.5-10	50	1050000000
WAP 2.5-10 BL	50	1050080000
WAP 16+35 WTW 2.5-10	20	1050100000
WAP 16+35 WTW 2.5-10 BL	20	1050180000
WEW 35/2	50	1061200000
WTA 2 WDU2.5-10	6 A 25	1632320000
WTA 2/ZA WDU2.5-10	6 A 25	1632330000
WAD 5 MC NE GE	48	1112920000
WAD 5 MC NE WS	48	1112910000
DEK 5/5 MC NE WS	1000	1609801044
WS 12/5 MC NE WS	720	1609860000
DEK 5/5 MM WS	800	2007110000
WS 8/5 MM WS	800	2007150000

Type	Qty.	Order No.
ZQV 4N/2	32 A 60	1527930000
ZQV 4N/10	32 A 20	1528090000
WQV 4/2	41 A 50	1051960000
WQV 4/10	41 A 20	1052060000
WAP 2.5-10	50	1050000000
WAP 2.5-10 BL	50	1050080000
WAP 16+35 WTW 2.5-10	20	1050100000
WAP 16+35 WTW 2.5-10 BL	20	1050180000
WEW 35/2	50	1061200000
WTA 3 WDU4	6 A 25	1632350000
WTA 3/ZA WDU4	6 A 25	1632360000
WAD 5 MC NE GE	48	1112920000
WAD 5 MC NE WS	48	1112910000
DEK 5/6 MM WS	600	2007120000
WS 12/6 MC NE WS	600	1609900000

For detailed information on other accessories and application in the online catalogue



WDU 16

16 mm²

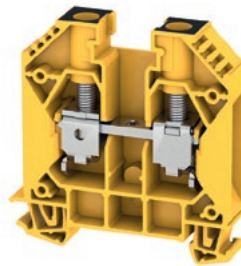

11.9 x 60 x 62.5
101 / 25
0.82...25



IEC 60947-7-1 Ex eb II C Gb II 2 G D

IEC	UL	CSA	EN 60079-7
1000			690
76			76
16			16 mm ²

8 kV / 3
B7 / V-0

DEMKO14ATEX1338U

Rated connection	Further connection
1.5...16 / 1.5...25	
1.5...25 / 1.5...16	
3...4 / (M 5)	
16 / 1.0 x 5.5 mm	

2 conductors with same cross-section (H05V/H07V)
Solid / Stranded mm ²
Flexible / Flexible with ferrule mm ²
Tightening torque / Clamping screw Nm
Stripping length / Blade size mm/-

Solid / Stranded mm ²	1.5...6 / 1.5...6
Flexible / Flexible with ferrule mm ²	1.5...6 / 1.5...6

Width/Height/Depth	mm
max. current / max. cond. cross-section	A/mm ²
Max. clamping range	mm ²

Technical data

Rated data	
Rated voltage	V
Rated current	A
for wire cross-section	mm ²
Rated impulse withstand voltage / Pollution severity	
Gauge to IEC 60947-1 / UL 94 flammability rating	

Approvals

Clamped conductors (H05V/H07V)	
Solid / Stranded	mm ²
Flexible / Flexible with ferrule	mm ²
Tightening torque / Clamping screw	Nm
Stripping length / Blade size	mm/-

2 conductors with same cross-section (H05V/H07V)	
Solid / Stranded	mm ²
Flexible / Flexible with ferrule	mm ²

Note

Ordering data

Version	
	yellow/black

Note

Accessories

Screwable cross-connection	
2-pole	
3-pole	
4-pole	
10-pole	

End plate / Partition plate	
dark beige	
Blue	

End bracket	
dark beige, screwable	
dark beige	

Cover	
black/yellow	
white	
With lightning flash symbol	
Blank, white	

Additional connection	
4 mm ²	
10 mm ²	

Marking tags	
DEK 5/5 MC NE WS	1000
WS 12/6.5 MC NE WS	540

Testing / Checking	
	Standard

For detailed information on other accessories and application in the online catalogue

WDU 16N

16 mm²



12 x 60 x 46.5
101 / 25
1.5...25

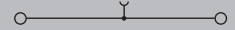

IEC 60947-7-1

IEC	UL	CSA	EN 60079-7
690	600		
76	70		
16	AWG 14...6		

8 kV / 3
B7 / V-0

DEMKO14ATEX1338U

Rated connection	Further connection
1.5...16 / 1.5...25	
1.5...16 / 1.5...16	
1.2...2.4 / (M 4)	
12 / 1.0 x 5.5 mm	

2 conductors with same cross-section (H05V/H07V)
Solid / Stranded mm ²
Flexible / Flexible with ferrule mm ²
Tightening torque / Clamping screw Nm
Stripping length / Blade size mm/-

Solid / Stranded mm ²	1.5...6 / 1.5...6
Flexible / Flexible with ferrule mm ²	1.5...6 / 1.5...6

Type	Qty.	Order No.
WDU 16N GE/SW	50	2000050000

Note

Type	Qty.	Order No.
WQV 16N/2	76 A 50	1636560000
WQV 16N/4	76 A 50	1636580000

WTW EN	Qty.	Order No.
WTW EN	20	1058800000

WEW 35/2	Qty.	Order No.
WEW 35/2	50	1061200000

WAD 12N GE BED	Qty.	Order No.
WAD 12N GE BED	50	1073200000
WAD 12N WS	50	1073290000

DEK 5/5 MC NE WS	Qty.	Order No.
DEK 5/5 MC NE WS	1000	1609801044
WS 10/12 MC NE WS	300	1905970000

WTA 2	Qty.	Order No.
WTA 2 WDU 2.5-10	6 A 25	1632320000

Note



Shielding and earthing
Functional earth – Screw connection

Application range



Width/Height/Depth	mm
max. current / max. cond. cross-section	A/mm ²
Max. clamping range	mm ²

Technical data

Rated data	
Rated voltage	V
Rated current	A
for wire cross-section	mm ²
Rated impulse withstand voltage / Pollution severity	
Gauge to IEC 60947-1 / UL 94 flammability rating	
Approvals	
Clamped conductors (H05V/H07V)	
Solid / Stranded	mm ²
Flexible / Flexible with ferrule	mm ²
Tightening torque / Clamping screw	Nm
Stripping length / Blade size	mm/-
2 conductors with same cross-section (H05V/H07V)	
Solid / Stranded	-
Flexible / Flexible with ferrule	-
Note	

Ordering data

Version	yellow/black
Note	

Accessories

Screwable cross-connection	2-pole 3-pole 4-pole 10-pole
End plate / Partition plate	dark beige Blue
End bracket	dark beige, screwable dark beige
Cover	black/yellow white With lightning flash symbol Blank, white
Additional connection	4mm ² 10mm ²
Marking tags	
Testing / Checking	Standard

For detailed information on other accessories and application in the online catalogue

WDU 35

35 mm²

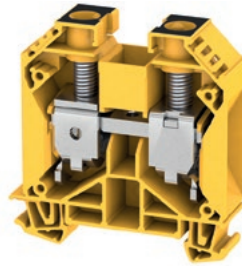

16 x 60 x 62.5	
150 / 50	
2.5...50	

IEC 60947-7-1				Ex eb II C Gb	II 2 G D
IEC	UL	CSA	EN 60079-7		
1000			690		
125			115		
35			35 mm ²		
				8 kV / 3	
				B8 / V-0	
				DEMKO14ATEX1338U	
Rated connection		Further connection			
2.5...16 / 2.5...50					
2.5...35 / 2.5...35					
4...5 / (M 6)					
18 / 6.5 x 1.2 mm					
Note					

Type	Qty.	Order No.
WDU 35 GE/SW	40	2000060000

Type	Qty.	Order No.
WQV 35/2	138 A 50	1053060000
WQV 35/10	112 A 10	1053160000
WAP 16+35 WTW 2.5-10	20	1050100000
WAP 16+35 WTW 2.5-10 BL	20	1050180000
WEW 35/1	50	1059000000
WAD 12 MC B GE/SW	32	2445090000
WAD 12 MC NE WS	32	2445070000
DEK 5/5 MC NE WS	1000	1609801044
WS 12/6.5 MC NE WS	540	1609920000

For detailed information on other accessories and application in the online catalogue

WDU 35N

35 mm²



16 x 66 x 50.5	
150 / 50	
2.5...50	

IEC 60947-7-1				Ex eb II C Gb	II 2 G D
IEC	UL	CSA	EN 60079-7		
500			352		
125			110		
35			35 mm ²		
				6 kV / 3	
				B8 / V-0	
				DEMKO14ATEX1338U	
Rated connection		Further connection			
2.5...16 / 2.5...50					
2.5...35 / 2.5...35					
4...5 / (M 6)					
18 / 6.5 x 1.2 mm					
Note					

Type	Qty.	Order No.
WDU 35N GE/SW	20	2000090000

Type	Qty.	Order No.
WQV 35N/2	125 A 20	1079200000
WQV 35N/4	125 A 20	1079400000
WTW EN	20	1058800000
WEW 35/2	50	1061200000
WAD 16N GE BED	50	1083600000
DEK 5/5 MC NE WS	1000	1609801044
WS 12/6.5 MC NE WS	540	1609920000

For detailed information on other accessories and application in the online catalogue

WDU 50N

50 mm²



18.5 x 70 x 69.6
192 / 70
10...70

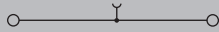

IEC 60947-7-1 Ex eb II C Gb  II 2 G D

IEC	UL	CSA	EN 60079-7
1000			690
150			126
50			50 mm ²

8 kV / 3
B10 / V-0

© CEE DEMKO14ATEX1338U

Rated connection	Further connection
6...16 / 6...70	
10...50	
3.5...6 / (M 6)	
24 / S4 (DIN 6911)	

Type	Qty.	Order No.
WDU 50N GE/SW	10	2000080000

Type	Qty.	Order No.
WQV 50N/2	150 A 5	1834060000
WQV 50N/3	150 A 5	1834070000
WQV 50N/4	150 A 5	1834080000

WEW 35/1	50	1059000000
----------	----	------------

WAD 20 GE WSD	10	9512260000
---------------	----	------------

WZAD 50N	41 A 5	1872720000
----------	--------	------------

DEK 5/5 MC NE WS	1000	1609801044
WS 12/6.5 MC NE WS	540	1609920000



Shielding and earthing Functional earth – Screw connection



WDU 70N/35

70 mm²



WDU 95N/120N

120 mm²



Width/Height/Depth	mm
max. current / max. cond. cross-section	A/mm ²
Max. clamping range	mm ²

20.5 x 75 x 85	
232 / 95	
16...95	

27 x 91 x 90	
290 / 150	
16...150	

Technical data

Rated data	
Rated voltage	V
Rated current	A
for wire cross-section	mm ²
Rated impulse withstand voltage / Pollution severity	
Gauge to IEC 60947-1 / UL 94 flammability rating	
Approvals	
Clamped conductors (H05V/H07V)	
Solid / Stranded	mm ²
Flexible / Flexible with ferrule	mm ²
Tightening torque / Clamping screw	Nm
Stripping length / Blade size	mm/-
2 conductors with same cross-section (H05V/H07V)	
Solid / Stranded	-
Flexible / Flexible with ferrule	-
Note	

IEC 60947-1	Ex eb II C Gb		II 2 G D
IEC	UL	CSA	EN 60079-7
1000	600		690
192	150		184
70	AWG 6...0		70 mm ²
8 kV / 3			
B11 / V-0			
© CE, TÜV, PCE, DEMKO14ATEX1338U			
Rated connection	Further connection		
16...16 / 16...95			
16...70 / 16...50			
8...12 / (M 8)			
22 / S6 (DIN 6911)			
Note			

IEC 60947-1	Ex eb II C Gb		II 2 G D
IEC	UL	CSA	EN 60079-7
1000			880
269			221
120			120 mm ²
8 kV / 3			
B13 / V-0			
© CE, DEMKO14ATEX1338U			
Rated connection	Further connection		
16...16 / 16...150			
16...120			
12...20 / (M 10)			
27 / S6 (DIN 6911)			
Note			

Ordering data

Version	
	yellow/black
Note	

Type	Qty.	Order No.
WDU 70N/35 GE/SW	10	2000100000
Note		

Type	Qty.	Order No.
WDU 95N/120N GE/SW	5	2000110000
Note		

Accessories

Screwable cross-connection	
	2-pole
	3-pole
	4-pole
End bracket	
	dark beige, screwable
Cover	
	With lightning flash symbol
Additional connection	
	10 mm ²
Marking tags	

Type	Qty.	Order No.
WQV 70N/2	192 A 5	9512240000
WQV 70N/3	192 A 5	9512250000
WQV 70N/4	192 A 5	9531290000
WEW 35/1	50	1059000000
WAD 20 GE WSD	10	9512260000
WZAD 70N	41 A 5	1964830000
DEK 5/5 MC NE WS	1000	1609801044
WS 12/6.5 MC NE WS	540	1609920000
Note		

Type	Qty.	Order No.
WQV 95N/120N/2	269 A 5	1826890000
WQV 95N/120N/3	269 A 5	1826900000
WQV 95N/120N/4	269 A 5	1826910000
WEW 35/1	50	1059000000
WAD 20 GE WSD	10	9512260000
WZAD 95N/120N	41 A 5	1859580000
DEK 5/5 MC NE WS	1000	1609801044
WS 12/6.5 MC NE WS	540	1609920000
Note		

For detailed information on other accessories and application in the online catalogue



Shielding and earthing
Earth conductor disconnect terminals – Tension clamp connection

ZTR 6-2 E

6 mm²

Operation mode



Width/Height/Depth	mm
max. current / max. cond. cross-section	A/mm ²
Max. clamping range	mm ²

16.2 x 70 x 50
20 / 10
0.05...10

Technical data

Rated data	
Rated voltage	V
Rated current	A
for wire cross-section	mm ²
Rated impulse withstand voltage / Pollution severity	
Gauge to IEC 60947-1 / UL 94 flammability rating	
Approvals	
Clamped conductors (H05V/H07V)	
Solid / Stranded	mm ²
Flexible / Flexible with ferrule	mm ²
Twin wire-end ferrule	-
Stripping length / Blade size	mm/-

IEC	UL	CSA	EN 60079-7
230	300		
20	25		
6	AWG 22...8		
8 kV / 3			
A5 / V-0			

Rated connection	
0.5...10 / 0.5..6	
0.5...6 / 0.5..6	
12 / 0.6 x 3.5 mm	

Note

Ordering data

Version	dark beige, 230 V UC dark beige, 24 V DC
Note	

Type	Qty.	Order No.
ZTR 6-2 E / 230V UC	10	8817930000
ZTR 6-2 E / 24V UC	10	8817920000

Accessories

End plate / Partition plate	dark beige
End bracket	dark beige
Test adapter	With spigot
Screwdriver	Standard

Type	Qty.	Order No.
ZAP ZDU6-2	50	1771440000
ZEW 35	20	9540000000
ZTA 7/ZA	9 A 25	1780670000
SDIS 0.6X3.5X100	1	2749810000

For detailed information on other accessories and application in the online catalogue

Operating mode

ZTR6-2 E

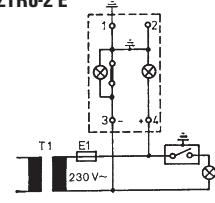

- Slide link is closed
- Auxiliary circuit is **earthed**
- Display is illuminated green

Test position

When measuring insulation resistance with voltages greater than U_{Nom}, the earth connection must first be disconnected.

ZTR6-2 E

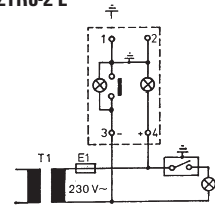

- Slide link is opened
- Auxiliary circuit is **not earthed**
- **No** earth fault
- Display illuminated green and red with reduced intensity
- Disconnected earth connection -> When measuring insulation resistance with voltages greater than U_{Nom}, the earth connection must be disconnected.

Operational malfunction

ZTR6-2 E

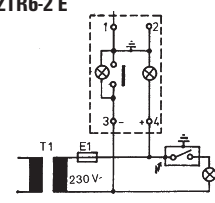

- Slide link is opened
- Auxiliary circuit is **not earthed**
- **Earth fault**
- Display is illuminated red



WTR 35 E

35 mm²

Operation mode



Width/Height/Depth	mm
max. current / max. cond. cross-section	A
Max. clamping range	mm ²

32 x 100 x 67.5	
125 / 35	
4...35	

Technical data

Rated data	
Rated voltage to adjoining terminal	-
Rated current	A
for wire cross-section	mm ²
Rated impulse withstand voltage / Pollution severity	
Gauge to IEC 60947-1 / UL 94 flammability rating	
Approvals	
Clamped conductors (H05V/H07V)	
Solid / Stranded	mm ²
Flexible / Flexible with ferrule	mm ²
Tightening torque / Clamping screw	Nm
Stripping length / Blade size	mm/-

IEC	UL	CSA	EN 60079-7
125			
35			
0.8 kV / 3			
B9 / V-0			
CE			
Rated connection			
4...16 / 10...35			
4...35 / 4...35			
4 / (M 6)			
18 / 1.2 x 6.5 mm			

Note

Ordering data

Version	dark beige, 24 V DC
Note	

Type	Qty.	Order No.
WTR 35 E	5	1045970000

Accessories

End bracket	dark beige, screwable
Screwdriver	Standard
Marking tags	

Type	Qty.	Order No.
WEW 35/1	50	1059000000
SDS 1.2X6.5X150	1	2749390000
WS 12/6 MC NE WS	600	1609900000

For detailed information on other accessories and application in the online catalogue

Operating mode

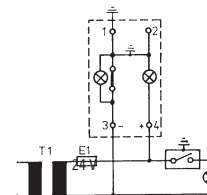

- Slide link is closed
- Auxiliary circuit is **earthed**
- Display is illuminated green

Test position

When measuring insulation resistance with voltages greater than U_{Nom} , the earth connection must first be disconnected.

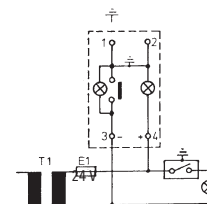

- Slide link is opened
- Auxiliary circuit is **not earthed**
- **No** earth fault
- Display illuminated green and red with reduced intensity
- Disconnected earth connection -> When measuring insulation resistance with voltages greater than U_{Nom} , the earth connection must be disconnected.

Operational malfunction

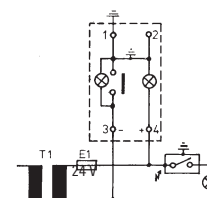

- Slide link is opened
- Auxiliary circuit is **not earthed**
- **Earth fault**
- Display is illuminated red

B



Compact planning, structured wiring

Klippon® Connect makes your installation wiring more effective

Installation wiring poses particular challenges in terms of the design of terminal blocks. The solutions need to be both economical and compact. Simple handling and clarity also need to be guaranteed. Installation distribution and small distributors offer little space for wiring. Our terminal blocks for building installations meet all requirements here. For example, the PUSH IN technology allows a particularly compact design while retaining its clarity, thus enabling simple and safe wiring of your building infrastructure.



Our promise

Our terminal blocks open up added-value options when it comes to wiring your building infrastructure. Thanks to the wide product range and the comfortable handling of the PUSH IN terminal blocks, Klippon® Connect helps improve flexibility and efficiency even from the planning phase.

B



Time saving

- Simple configuration and ordering of terminal strips using the Weidmüller Configurator
- More flexibility: it is simple to replace the PDL PUSH IN terminal blocks in the group
- Innovative screwless N-slider

Space saving

- Really compact design of PUSH IN terminal blocks
- Neutral busbars for all terminals at the same level
- Double cross-connection channel despite compact design

Flexibility

- 3-phase cross-connection system with L1, L2 and L3 potentials within a terminal strip
- High current-carrying capacity despite compact size
- Thanks to the disconnecter slider, insulation can be tested without disconnecting the neutral connector

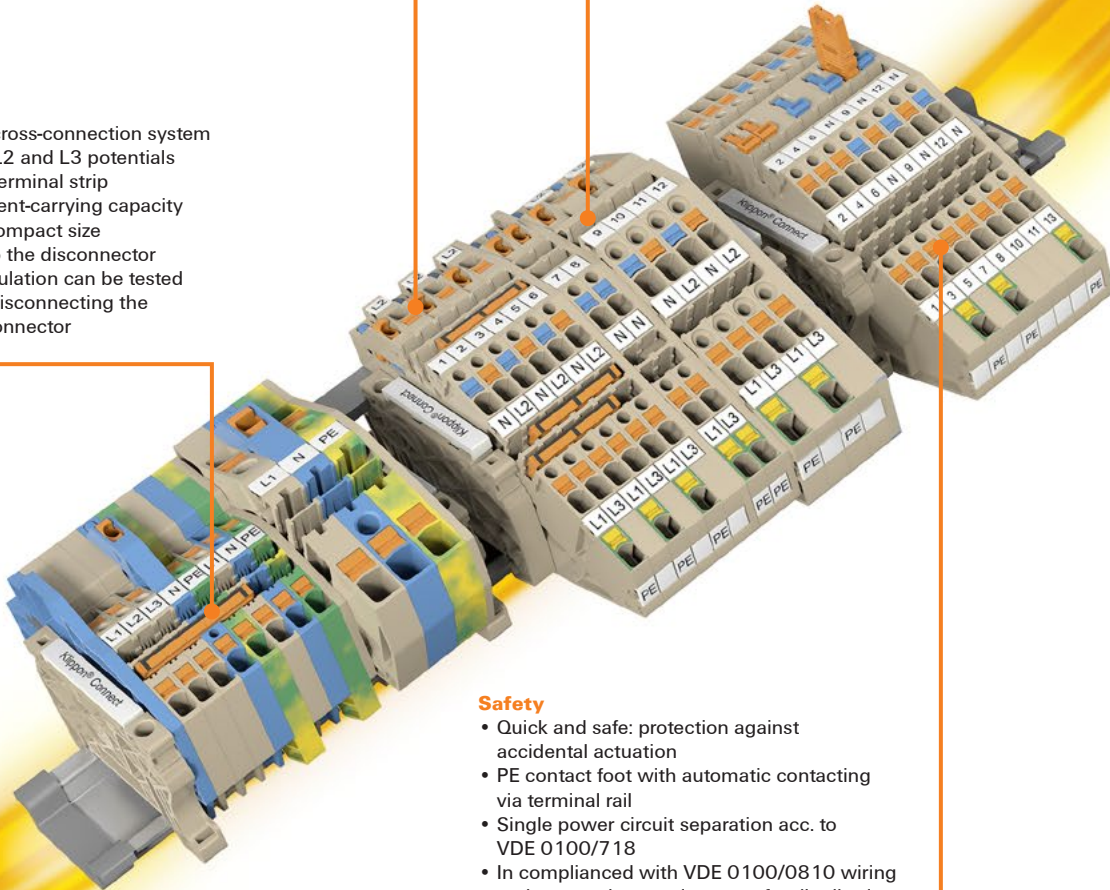

Safety

- Quick and safe: protection against accidental actuation
- PE contact foot with automatic contacting via terminal rail
- Single power circuit separation acc. to VDE 0100/718
- In compliance with VDE 0100/0810 wiring and connection requirements for distribution systems in public buildings

Our range

The right solution for every requirement:

For building installation, we offer a perfectly tailored overall system based on 10×3 copper rails. These consist of installation, distribution and neutral conductor terminals in various connection technologies and an extensive range of accessories.

More effective wiring with PUSH IN:

Our PUSH IN terminal blocks for building and plant installation are impressively easy to handle and very flexible. This comprehensive range covers all the important terminal block functions and offers you significant benefits in all processes. You will benefit from reduced installation times, as well as increased performance data and clarity, thanks to the compact design.



Klippon® Connect AITB building installation wiring terminal blocks

Get real added value for your building installations

A large number of standards and regulations govern the building industry. As a result, high safety standards must be met for electrical installations. These standards also apply to a wide range of components that have to be integrated into complex control cabinets in a confined space.



Our new AITB modular terminal block system was specially developed to meet the specific requirements and safety regulations for wiring in building installations. Special features of the series ensure real added value in planning, installation and operation on site.

B

Combination of different connection techniques

A uniform busbar position enables the combination of different terminal block products and connection technologies in one complete system. For large cross-sections – e.g. N conductors – the side screw terminal connection is available. Terminal blocks with convenient PUSH IN connection technology are used to collect and distribute potentials.

Safe disconnection of the neutral conductor

The neutral conductor can be separated from the busbar quickly and easily with a screwdriver. A clearly visible status display indicates the current contact position of the disconnecting slide. This reliably prevents operating errors.

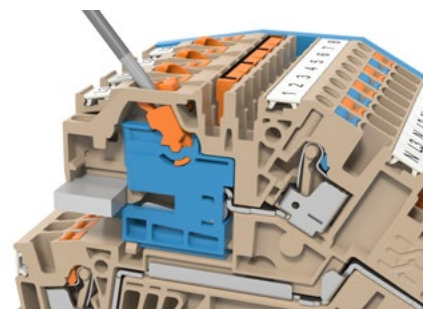

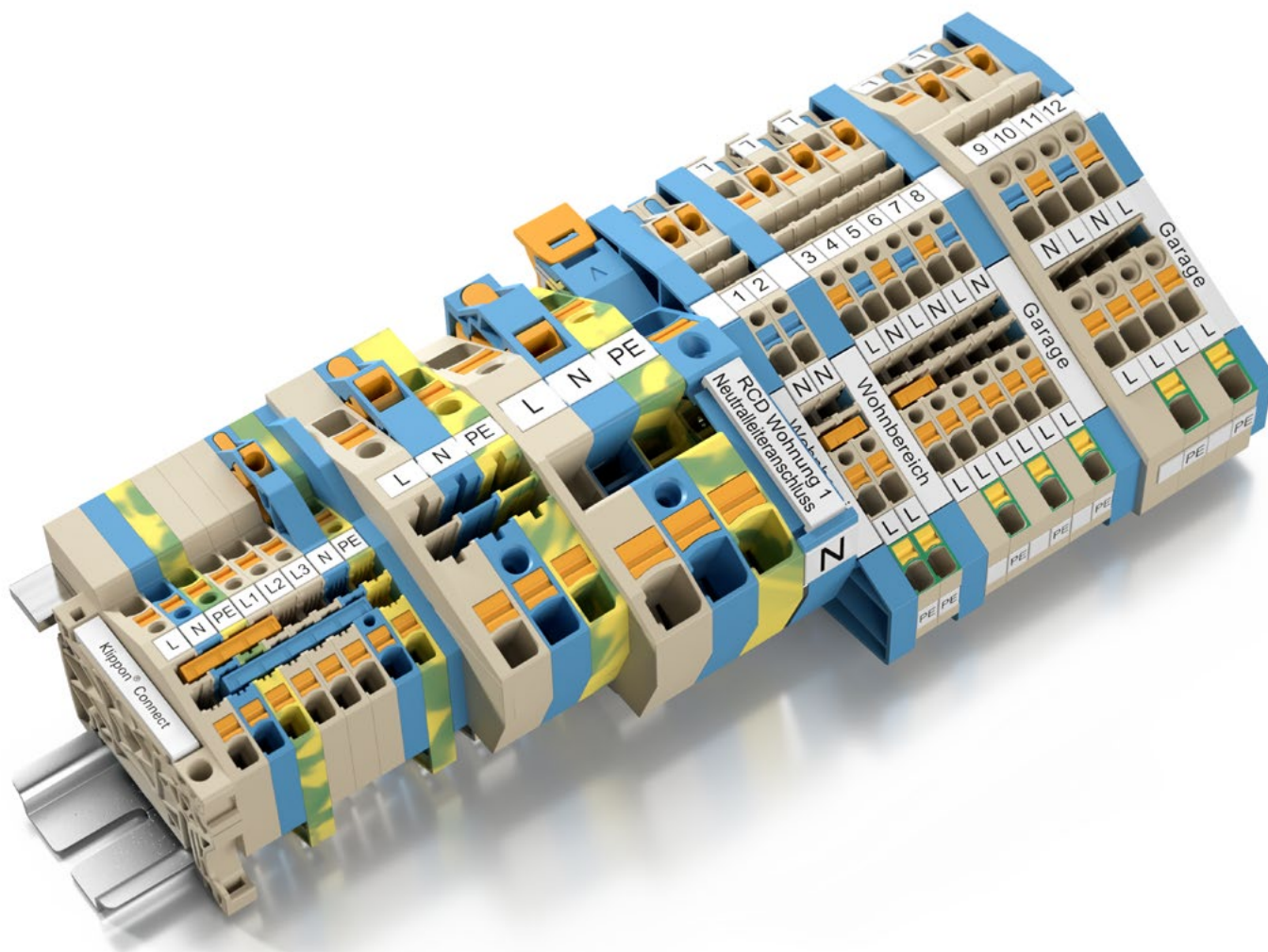

Digital assembly in the WMC

In the Weidmüller Configurator (WMC) you can digitally plan, assemble, and directly order complete terminal rails – including accessories. You can also create complete parts lists and installation instructions for production. In this way, failures can be avoided and costs can be saved.

Flexible cross-connection options

The continuous cross-connection channels of our modular terminal blocks AITB increase flexibility and save wiring time. Structures in the 400 V three-phase system can be cross-connected easily and conveniently with the phase conductors L1, L2, and L3.

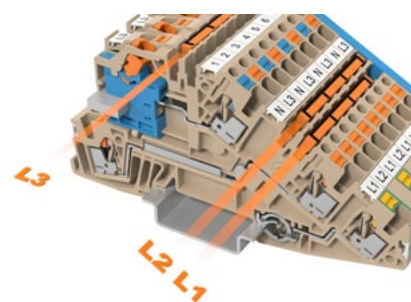
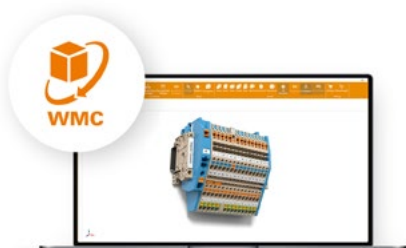

Plan, install, and operate optimally

Planning – with perfect support

Digital assembly in the WMC

In the Weidmüller Configurator (WMC) you can digitally plan, assemble, and directly order complete terminal rails – including accessories. You can also create complete parts lists and installation instructions for production. In this way, failures can be avoided and costs can be saved.

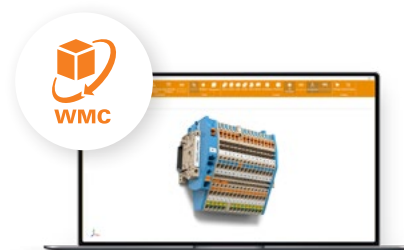

B

Wide range of functions

Modular terminal blocks AITB have a multifunctional disconnect area. It can accommodate either a fuse holder, a disconnecter, or a component plug. Thus, the terminal block can be used within an application as a disconnect terminal block, a fuse terminal block, or as a terminal block with electronic components inside.

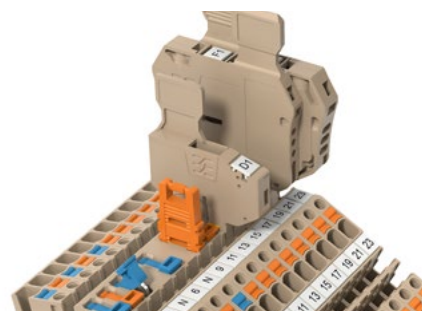

Flexible cross-connection options

The continuous cross-connection channels of our modular terminal blocks AITB increase flexibility and save wiring time. Structures in the 400 V three-phase system can be cross-connected easily and conveniently with the phase conductors L1, L2, and L3.

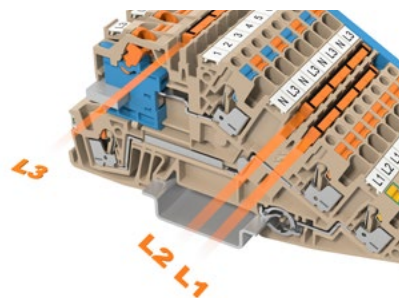

Standard-compliant safety

Our modular terminal blocks AITB are regularly inspected by independent test centres to ensure maximum product safety within the switchgear. This is immediately shown by the corresponding test marks on the products and product labels.



Plan, install, and operate optimally

Installation – simple, fast, and safe

Ready to robot

Our modular terminal blocks AITB already support robot-assisted assembly, marking, and wiring. So you are optimally prepared for the advancing partial automation in control cabinet construction.

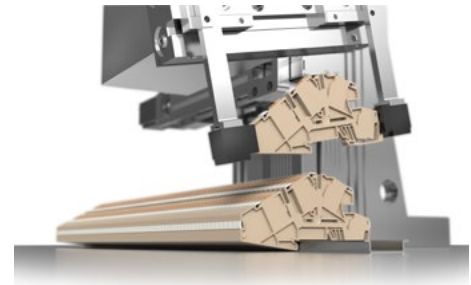

Convenient PUSH IN technology

NYM cables and other solid conductors are simply pushed into the clamping point after stripping to create a reliable connection. Even fine-stranded conductors can be connected by simply pressing the coloured pusher. No special tools required!

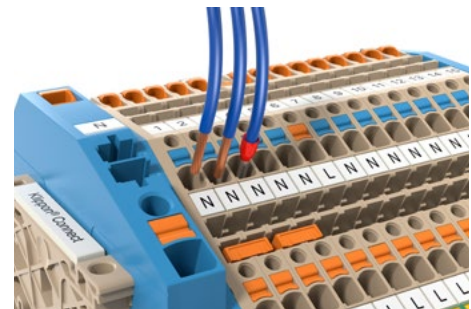

Combination of different connection techniques

A uniform busbar position enables the combination of different terminal block products and connection technologies in one complete system. For large cross-sections – e.g. N conductors – the side screw terminal connection is available. Terminal blocks with convenient PUSH IN connection technology are used to collect and distribute potentials.

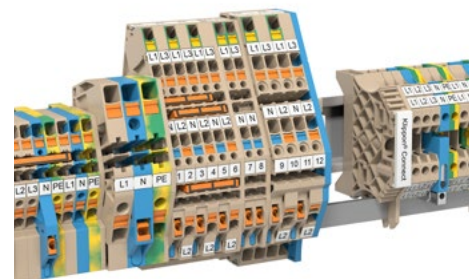

Clearly distinguishable functional areas

The different functional areas can be clearly distinguished by shape or colour. For example, conductor connection, cross-connections, and test hole can be clearly identified. Installation and maintenance work can be carried out quickly and without errors.



B



Plan, install, and operate optimally Operation – norm-compliant and safe

FI/LS circuits

If many FI/LS circuits are used in an installation, each N potential can be routed and separated via the individual isolator. This enables measuring the insulation resistance of all conductors to earth, as required by VDE 0100-718 and DIN VDE 0100-482, without disconnecting the neutral conductor.

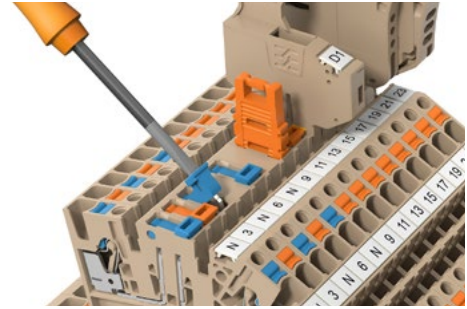

Safe disconnection of the neutral conductor

The neutral conductor can be separated from the busbar quickly and easily with a screwdriver. A clearly visible status display indicates the current contact position of the disconnecting slide. This reliably prevents operating errors.

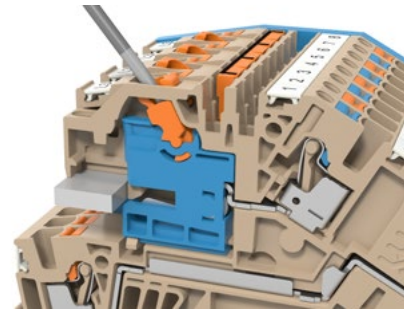

Quick assembly and disassembly

AITB modular terminals can be mounted and dismantled quickly and easily – even in combination. This also applies if a busbar with modular terminal blocks AITB of the A-Series is already integrated into the system. This speeds up maintenance work and components can be retrofitted or replaced in a minimum of time.

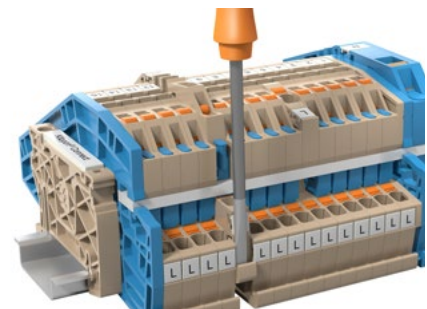

Simple standardised system tests

With modular terminal blocks AITB, no conductive components can be reached with voltage testers when wired. This makes operation safer, but also hinders the use of test probes. In order to carry out the required measurements, standardised test holes with a practical snap-in mechanism have been integrated. Once the test probes are snapped in, the test report can be filled out while the measurement is in progress.

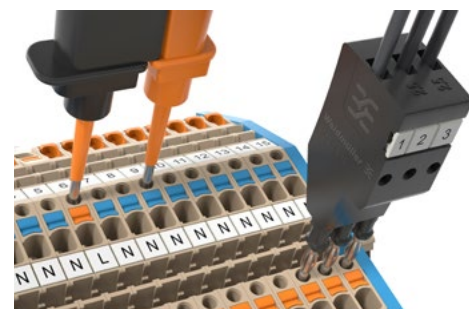

Easily meet growing safety standards

Standardised measurements in electrical switchgear

High safety requirements and standards in building technology protect the people who live and work in a building. For this purpose, there are numerous standards covering every component in the entire system, no matter how small. These norms and standards also increase the safety requirements for all electrical systems and their components – for example, the terminal block system that acts as the interface between the electrical system and the building.

Measurement of insulation resistance

When planning and installing control cabinets in buildings, the opening and closing of circuits is one of the normative requirements. Depending on the number of circuit groups within an object, the separation can be carried out via a standard disconnecter or a disconnecting slide. The required measurement of the insulation resistance of all conductors to earth must be carried out without disconnecting the neutral conductor in accordance with VDE 0100-718 and DIN VDE 0100-482. In smaller circuits with few current paths, the measurement is carried out using standard disconnectors. In larger circuits with many individual current paths, a disconnecting slide is used to ensure contact with the 10x3 busbar. The measurement itself could be realized conveniently and safely via the integrated test adapter at the respective terminal point of the terminal block.

Measurements in small circuit groups

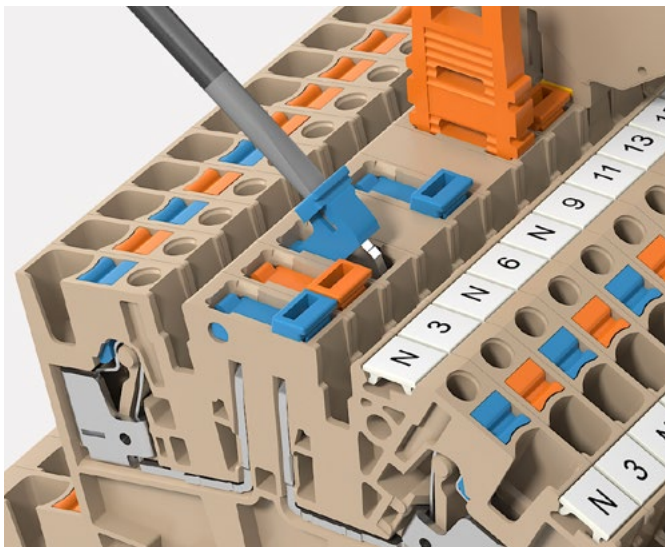

VDE 0100-718 and DIN VDE 0100-482 require a measurement of the insulation resistance of all conductors to earth without disconnecting the neutral conductor. In buildings with many FI/LS circuits, each room or current path may represent a single circuit that must be considered separately during the measurement. With the AITB terminal blocks, each N potential can be routed separately via individual isolators and separated for insulation measurements. The measurement itself could be realized conveniently and safely via the integrated test adapter at the respective terminal point of the terminal block.

Measurements in large circuit groups

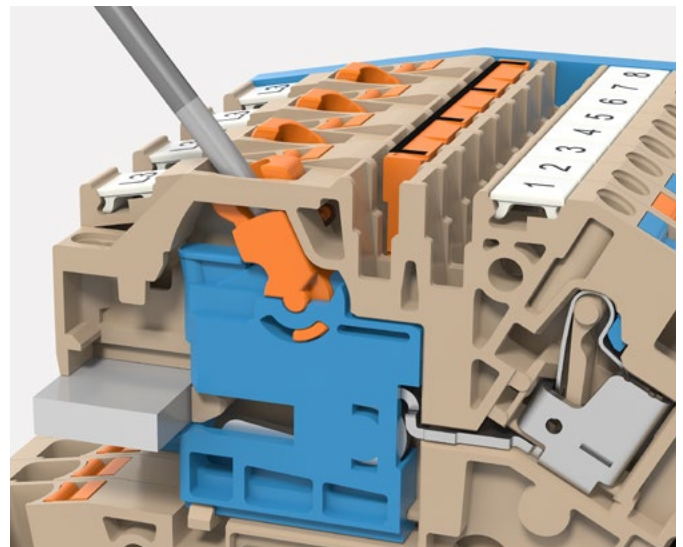

In large circuit groups, the safe contact to the copper bar is established via a disconnecting slide. This closes a circuit that extends over the isolating slider to the copper bar. If the slider is levered to the end position, it opens the contact to the copper bar. Thus, the circuit is interrupted and measurements can be carried out conveniently and safely via the integrated test adapter at the respective terminal point of the terminal block. The clearly visible position indicator provides quick and reliable information about the current status of the system. It can also be read in the wired state.





AITB 2.5 BB 2C

2.5 mm²

AITB 6 BB 2C

6 mm²



Width/Height/Depth	mm
Rated current / max. cond. cross-section	A/mm ²
Max. clamping range	mm ²

5.1 x 63.8 x 43.6
24 / 4
0.14...4

8.1 x 76.6 x 52.9
41 / 10
0.34...10

Technical data

Rated data	
Rated voltage	V
Rated current	A
for wire cross-section	mm ²
Rated impulse withstand voltage / Pollution severity	
Gauge to IEC 60947-1 / UL 94 flammability rating	
Approvals	
Clamped conductors (H05V/H07V)	
Solid / Stranded	mm ²
Flexible / Flexible with ferrule	mm ²
Twin wire-end ferrule	mm ²
Stripping length / Blade size	mm/-

IEC 60947-7-1

IEC	UL	CSA	EN 60079-7
800			
24			
2.5			
	8 kV / 3		
	A3 / V-0		

CE

Rated connection	
0.5...4 / 0.5...4	
0.5...4 / 0.5...2.5	
0.5...0.75	
10 / 0.6 x 3.5 mm	

IEC 60947-7-1

IEC	UL	CSA	EN 60079-7
800			
41			
6			
	8 kV / 3		
	A5 / V-0		

CE

Rated connection	
0.5...10 / 0.5...10	
0.5...10 / 0.5...6	
0.5...1.5	
12 / 1.0 x 5.5 mm	

Note

Ordering data

Version	
	dark beige
	Blue

Note

Type	Qty.	Order No.
AITB 2.5 BB 2C	50	2668660000
AITB 2.5 BB 2C BL	50	2668670000

Type	Qty.	Order No.
AITB 6 BB 2C	50	2668700000
AITB 6 BB 2C BL	50	2668710000

Accessories

Plug-in cross-connection	
	2-pole
	3-pole
	4-pole
	10-pole
	2-pole
	2-pole
End plate	
	dark beige
	blue
Support bracket for 10 x 3 (required every 20 cm)	
	blue
End bracket	
	dark beige, direct mounting
	blue
	blue
Test adapter	
	1-pole
	stackable
	3-pole
	5-pole
Test plug	
Screwdriver	
	Standard
Busbar 10 x 3 (140 A)	
Marking tags	

For detailed information on other accessories and application in the online catalogue

Type	Qty.	Order No.
ZQV 2.5N/2	24 A 60	1527540000
ZQV 2.5N/3	24 A 60	1527570000
ZQV 2.5N/4	24 A 60	1527590000
ZQV 2.5N/10	24 A 20	1527690000
AEP ITB 2.5 BB 2C	20	2668780000
AEP ITB 2.5 BB 2C BL	20	2668790000
APP ITB 2.5 BB 2C/NDT BL	20	2668870000
AEB 35 SCL/1 V0	20	2661280000
AEB ITB 2.5/4 BB BL	25	2690440000
AEB ITB 16 BB BL	20	2669130000
PS 2.0 MC	20	0310000000
SDIL 0,6X3,5X100	1	2749140000
SSCH 10X3X1000 CU/SN	140 A 1	0348900000
DEK 5/5 PLUS MC NE WS	1000	1854490000
DEK 5/5 MM WS	800	2007110000

Type	Qty.	Order No.
ZQV 6N/2	41 A 60	1985740000
AEP ITB 6 BB 2C	20	2668810000
AEP ITB 6 BB 2C BL	20	2668820000
APP ITB 6 BB 2C/NDT BL	20	2668880000
AEB 35 SCL/1 V0	20	2661280000
AEB ITB 2.5/4 BB BL	25	2690440000
AEB ITB 16 BB BL	20	2669130000
ATPG 1.5-10 L	0.2 A 50	1991890000
ATPG 6 MHR	0.2 A 50	1991930000
PS 2.0 MC	20	0310000000
SDIL 1,0X5,5X125	1	2749160000
SSCH 10X3X1000 CU/SN	140 A 1	0348900000
DEK 5/8 MC NE WS	800	1856740000



AITB 16 BB 2C

16 mm²



10 x 84.6 x 52.9

76 / 16

0.5...16



IEC 60947-7-1

IEC	UL	CSA	EN 60079-7
800			
76			
16			
		8 kV / 3	
		A6 / V-0	



Rated connection

0.5...16 / 10...16

0.5...16 / 0.5...10

0.75...6

18 / 1.0 x 5.5 mm

Type	Qty.	Order No.
AITB 16 BB 2C	20	2668740000
AITB 16 BB 2C BL	20	2668750000

Type	Qty.	Order No.
ZQV 10N/2	57 A 25	2497250000
AEP ITB 16 BB 2C	20	2668840000
AEP ITB 16 BB 2C BL	20	2668850000
APP ITB 16 BB 2C/NDT BL	20	2668890000
AEB 35 SCL/1 VO	20	2661280000
AEB ITB 2.5/4 BB BL	25	2690440000
AEB ITB 16 BB BL	20	2669130000
ATPG 1.5-10 L	0.2 A 50	1991890000
PS 2.0 MC	20	0310000000
SDIL 1,0X5,5X125	1	2749160000
SSCH 10X3X1000 CU/SN	140 A 1	0348900000
WS-A 8/10 MM WS	350	2619890000
WS 8/6 PLUS MC NE WS	600	1951880000
WS 7.8/9.2 PLUS MC NE GR	360	1208970000





AITB 2.5 BB 2C PE

2.5 mm²

AITB 6 BB 2C PE

6 mm²



Width/Height/Depth	mm
Rated current / max. cond. cross-section	-/mm ²
Max. clamping range	mm ²

5.1 x 63.8 x 43.6	/ 4	
0.14...4		

8.1 x 76.6 x 52.9	/ 10	
0.34...10		

Technical data

Rated data	
Rated voltage to adjoining terminal	V
Rated current	-
for wire cross-section	mm ²
Rated impulse withstand voltage / Pollution severity	
Gauge to IEC 60947-1 / UL 94 flammability rating	
Approvals	
Clamped conductors (H05V/H07V)	
Solid / Stranded	mm ²
Flexible / Flexible with ferrule	mm ²
Twin wire-end ferrule	mm ²
Stripping length / Blade size	mm/-

IEC 60947-7-2			
IEC	UL	CSA	EN 60079-7
800			
2.5			
	8 kV / 3		
	A3 / V-0		
CE			
Rated connection			
0.5...4 / 0.5...4			
0.5...4 / 0.5...2.5			
0.5...0.75			
10 / 0.6 x 3.5 mm			

IEC 60947-7-2			
IEC	UL	CSA	EN 60079-7
800			
6			
	8 kV / 3		
	A5 / V-0		
CE			
Rated connection			
0.5...10 / 0.5...10			
0.5...10 / 0.5...6			
0.5...1.5			
12 / 1.0 x 5.5 mm			

Note

Ordering data

Version	green/yellow
Note	

Type	Qty.	Order No.
AITB 2.5 BB 2C PE	50	2668680000

Type	Qty.	Order No.
AITB 6 BB 2C PE	50	2668720000

Accessories

End plate	dark beige
Support bracket for 10 x 3 (required every 20 cm)	blue
End bracket	dark beige, direct mounting blue blue
Test adapter	1-pole stackable
Test plug	
Screwdriver	Standard
Busbar 10 x 3 (140 A)	
Marking tags	

Type	Qty.	Order No.
AEP ITB 2.5 BB 2C	20	2668780000
APP ITB 2.5 BB 2C/NDT BL	20	2668870000
AEB 35 SCL/1 V0	20	2661280000
AEB ITB 2.5/4 BB BL	25	2690440000
AEB ITB 16 BB BL	20	2669130000
ATPG 1.5-10 L	0.2 A 50	1991890000
ATPG 2.5 MI-R	0.2 A 50	1991960000
PS 2.0 MC	20	0310000000
SDIL 0,6X3,5X100	1	2749140000
SSCH 10X3X1000 CU/SN	140 A 1	0348900000
DEK 5/5 PLUS MC NE WS	1000	1854490000
DEK 5/5 MM WS	800	2007110000

Type	Qty.	Order No.
AEP ITB 6 BB 2C	20	2668810000
APP ITB 6 BB 2C/NDT BL	20	2668880000
AEB 35 SCL/1 V0	20	2661280000
AEB ITB 2.5/4 BB BL	25	2690440000
AEB ITB 16 BB BL	20	2669130000
ATPG 1.5-10 L	0.2 A 50	1991890000
ATPG 6 MI-R	0.2 A 50	1991930000
PS 2.0 MC	20	0310000000
SDIL 1,0X5,5X125	1	2749160000
SSCH 10X3X1000 CU/SN	140 A 1	0348900000
DEK 5/8 MC NE WS	800	1856740000

For detailed information on other accessories and application in the online catalogue



AITB 16 BB 2C PE

16 mm²



10 x 84.6 x 52.9
/ 16
0.5...16



IEC 60947-7-2

IEC	UL	CSA	EN 60079-7
800			
16			
	8 kV / 3		
	A6 / V-0		



Rated connection

0.5...16 / 10...16

0.5...16 / 0.5...10

0.75...6

18 / 1.0 x 5.5 mm

Type	Qty.	Order No.
AITB 16 BB 2C PE	20	2668760000

Type	Qty.	Order No.
AEP ITB 16 BB 2C	20	2668840000
APP ITB 16 BB 2C/NDT BL	20	2668890000
AEB 35 SCL/1 V0	20	2661280000
AEB ITB 2.5/4 BB BL	25	2690440000
AEB ITB 16 BB BL	20	2669130000
ATPG 1.5-10 L	0.2 A 50	1991890000
PS 2.0 MC	20	0310000000
SDIL 1,0X5,5X125	1	2749160000
SSCH 10X3X1000 CU/SN	140 A 1	0348900000
WS-A 8/10 MM WS	350	2619890000
WS 7.8/9.2 PLUS MC NE GR	360	1208970000





AITB 2.5 BB NDT BL

2.5 mm²

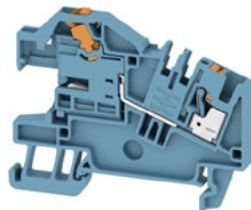

AITB 6 BB NDT BL

6 mm²

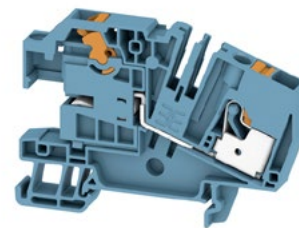

Width/Height/Depth	mm
Rated current / max. cond. cross-section	A/mm ²
Max. clamping range	mm ²

5.1 x 63.8 x 50
24 / 4
0.14...4

8.1 x 76.6 x 52.9
41 / 10
0.34...10

Technical data

Rated data	
Rated voltage	V
Rated current	A
for wire cross-section	mm ²
Rated impulse withstand voltage / Pollution severity	
Gauge to IEC 60947-1 / UL 94 flammability rating	
Approvals	
Clamped conductors (H05V/H07V)	
Solid / Stranded	mm ²
Flexible / Flexible with ferrule	mm ²
Twin wire-end ferrule	mm ²
Stripping length / Blade size	mm/-

In accordance with IEC 60947-7-1

IEC	UL	CSA	EN 60079-7
250			
24			
2.5			
	4 kV / 3		
	A3 / V-0		

CE

Rated connection	
0.5...4 / 0.5...4	
0.5...4 / 0.5...2.5	
0.5...0.75	
10 / 0.6 x 3.5 mm	

In accordance with IEC 60947-7-1

IEC	UL	CSA	EN 60079-7
800			
41			
6			
	4 kV / 3		
	A5 / V-0		

CE

Rated connection	
0.5...10 / 0.5...10	
0.5...10 / 0.5...6	
0.5...1.5	
12 / 1.0 x 5.5 mm	

Note

Ordering data

Version	Blue
Note	

Type	Qty.	Order No.
AITB 2.5 BB NDT BL	50	2668690000

Type	Qty.	Order No.
AITB 6 BB NDT BL	50	2668730000

Accessories

Plug-in cross-connection	
2-pole / blue	
3-pole / blue	
4-pole / blue	
10-pole/ blue	
2-pole	
End plate	
blue	
Support bracket for 10 x 3 (required every 20 cm)	
blue	
End bracket	
dark beige, direct mounting	
blue	
blue	
Test adapter	
1-pole	
stackable	
3-pole	
5-pole	
Test plug	
Standard	
Screwdriver	
Standard	
Busbar 10 x 3 (140 A)	
Marking tags	

Type	Qty.	Order No.
ZQV 2.5N/2 BL	24 A 60	1527740000
ZQV 2.5N/3 BL	24 A 60	1527770000
ZQV 2.5N/4 BL	24 A 60	1527780000
ZQV 2.5N/10 BL	24 A 20	1527880000
AEP ITB 2.5 BB NDT BL	20	2668800000
APP ITB 2.5 BB 2C/NDT BL	20	2668870000
AEB 35 SCL/1 V0	20	2661280000
AEB ITB 2.5/4 BB BL	25	2690440000
AEB ITB 16 BB BL	20	2669130000
ATPG 1.5-10 L	0.2 A 50	1991890000
ATPG 2.5 MI-R	0.2 A 50	1991960000
ATPG 2.5/3	0.2 A 25	2041190000
ATPG 2.5/5	0.2 A 25	2041180000
PS 2.0 MC	20	0310000000
SDIL 0,6X3,5X100	1	2749140000
SSCH 10X3X1000 CU/SN	140 A 1	0348900000
DEK 5/5 PLUS MC NE WS	1000	1854490000
DEK 5/5 MM WS	800	2007110000

Type	Qty.	Order No.
ZQV 6N/2 BL	41 A 60	1985830000
AEP ITB 6 BB NDT BL	20	2668830000
APP ITB 6 BB 2C/NDT BL	20	2668880000
AEB 35 SCL/1 V0	20	2661280000
AEB ITB 2.5/4 BB BL	25	2690440000
AEB ITB 16 BB BL	20	2669130000
ATPG 1.5-10 L	0.2 A 50	1991890000
ATPG 6 MI-R	0.2 A 50	1991930000
PS 2.0 MC	20	0310000000
SDIL 1,0X5,5X125	1	2749160000
SSCH 10X3X1000 CU/SN	140 A 1	0348900000
DEK 5/8 MC NE WS	800	1856740000

For detailed information on other accessories and application in the online catalogue



AITB 16 BB NDT BL

16 mm²



10 x 84.6 x 52.9

76 / 16

0.5...16



In accordance with IEC 60947-7-1

IEC	UL	CSA	EN 60079-7
400			
76			
16			
		4 kV / 3	
		A6 / V-0	



Rated connection

0.5...16 / 10...16

0.5...16 / 0.5...10

0.75...6

18 / 1.0 x 5.5 mm

Type	Qty.	Order No.
AITB 16 BB NDT BL	20	2668770000

Type	Qty.	Order No.
ZQV 10N/2	57 A 25	2497250000
AEP ITB 16 BB NDT BL	20	2668860000
APP ITB 16 BB 2C/NDT BL	20	2668890000
AEB 35 SCL/1 V0	20	2661280000
AEB ITB 2.5/4 BB BL	25	2690440000
AEB ITB 16 BB BL	20	2669130000
ATPG 1.5-10 L	0.2 A 50	1991890000
PS 2.0 MC	20	0310000000
SDIL 1,0x5,5x125	1	2749160000
SSCH 10X3X1000 CU/SN	140 A 1	0348900000
WS-A 8/10 MM WS	350	2619890000
WS 8/6 PLUS MC NE WS	600	1951880000
WS 7.8/9.2 PLUS MC NE GR	360	1208970000





Width/Height/Depth	mm
Rated current / max. cond. cross-section	A/mm ²
Max. clamping range	mm ²

Technical data

Rated data	
Rated voltage	V
max. current	A
for wire cross-section	mm ²
Rated impulse withstand voltage / Pollution severity	
Gauge to IEC 60947-1 / UL 94 flammability rating	
Approvals	
Clamped conductors (H05V/H07V)	
Solid / Stranded	mm ²
Flexible / Flexible with ferrule	mm ²
Twin wire-end ferrule	mm ²
Stripping length / Blade size	mm/-
Rated voltage	
Rated voltage (L / L)	V
Rated voltage (L / N)	V
Rated voltage (L / PE)	V

Note

Ordering data

Version	
	dark beige
Note	

Accessories

Plug-in cross-connection	
	2-pole
	3-pole
	4-pole
	10-pole
End plate	
	dark beige
Support bracket for 10 x 3 (required every 20 cm)	
	blue
	blue, incl. metal holder for the busbar
End bracket	
	dark beige, direct mounting
	blue
	blue
Test adapter	
	1-pole
	stackable
	3-pole
	5-pole
Test plug	
Screwdriver	
	Standard
Busbar 10 x 3 (140 A)	
Marking tags	
For detailed information on other accessories and application in the online catalogue	

AITB 2.5 BB L

2.5 mm²



5.1 x 103 x 50.1	
24 / 4	
0.14...4	

IEC 60947-7-1			
IEC	UL	CSA	EN 60079-7
400			
27			
2.5			
	4 kV / 3		
	A3 / V-0		
CE			
Rated connection			
0.5...4 / 0.5...4			
0.5...4 / 0.5...2.5			
0.5...0.75			
10 / 0.6 x 3.5 mm			
CE			
Rated voltage			
400			
250			
250			

Type	Qty.	Order No.
AITB 2.5 BB L	50	2668920000

Type	Qty.	Order No.
ZQV 2.5N/2	24 A 60	1527540000
ZQV 2.5N/3	24 A 60	1527570000
ZQV 2.5N/4	24 A 60	1527590000
ZQV 2.5N/10	24 A 20	1527690000
AEP ITB 2.5 BB	20	2668960000
APP ITB 2.5 BB BL	20	2668970000
APP ITB 2.5 BB BL VI		2881640000
AEB 35 SCL/1 V0	20	2661280000
AEB ITB 2.5/4 BB BL	25	2690440000
AEB ITB 16 BB BL	20	2669130000
ATPG 1.5-10 L	0.2 A 50	1991890000
ATPG 2.5 MHR	0.2 A 50	1991960000
ATPG 2.5/3	0.2 A 25	2041190000
ATPG 2.5/5	0.2 A 25	2041180000
PS 2.0 MC	20	0310000000
SDIL 0,6X3,5X100	1	2749140000
SSCH 10X3X1000 CU/SN	140 A 1	0348900000
DEK 5/5 PLUS MC NE WS	1000	1854490000
DEK 5/5 MM WS	800	2007110000

AITB 2.5 BB N-L-PE

2.5 mm²



5.1 x 103 x 50.1	
24 / 4	
0.14...4	

IEC 60947-7-1 (-7-2)			
IEC	UL	CSA	EN 60079-7
250			
27			
2.5			
	4 kV / 3		
	A3 / V-0		
CE			
Rated connection			
0.5...4 / 0.5...4			
0.5...4 / 0.5...2.5			
0.5...0.75			
10 / 0.6 x 3.5 mm			
CE			
Rated voltage			
400			
250			
250			

Type	Qty.	Order No.
AITB 2.5 BB N-L-PE	50	2668940000

Type	Qty.	Order No.
ZQV 2.5N/2	24 A 60	1527540000
ZQV 2.5N/3	24 A 60	1527570000
ZQV 2.5N/4	24 A 60	1527590000
ZQV 2.5N/10	24 A 20	1527690000
AEP ITB 2.5 BB	20	2668960000
APP ITB 2.5 BB BL	20	2668970000
APP ITB 2.5 BB BL VI		2881640000
AEB 35 SCL/1 V0	20	2661280000
AEB ITB 2.5/4 BB BL	25	2690440000
AEB ITB 16 BB BL	20	2669130000
ATPG 1.5-10 L	0.2 A 50	1991890000
ATPG 2.5 MHR	0.2 A 50	1991960000
ATPG 2.5/3	0.2 A 25	2041190000
ATPG 2.5/5	0.2 A 25	2041180000
PS 2.0 MC	20	0310000000
SDIL 0,6X3,5X100	1	2749140000
SSCH 10X3X1000 CU/SN	140 A 1	0348900000
DEK 5/5 PLUS MC NE WS	1000	1854490000
DEK 5/5 MM WS	800	2007110000



AITB 2.5 BB N-L

2.5 mm²



5.1 x 103 x 50.1
24 / 4
0.14...4

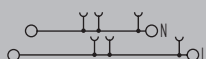

IEC 60947-7-1

IEC	UL	CSA	EN 60079-7
400			
27			
2.5			
		4 kV / 3	
		A3 / V-0	

CE

Rated connection

0.5...4 / 0.5...4
0.5...4 / 0.5...2.5
0.5...0.75
10 / 0.6 x 3.5 mm

400
250
250

Type	Qty.	Order No.
AITB 2.5 BB N-L	50	2668910000

Type	Qty.	Order No.
ZQV 2.5N/2	24 A 60	1527540000
ZQV 2.5N/3	24 A 60	1527570000
ZQV 2.5N/4	24 A 60	1527590000
ZQV 2.5N/10	24 A 20	1527690000
AEP ITB 2.5 BB	20	2668960000
APP ITB 2.5 BB BL	20	2668970000
APP ITB 2.5 BB BL VI		2881640000
AEB 35 SCL/1 V0	20	2661280000
AEB ITB 2.5/4 BB BL	25	2690440000
AEB ITB 16 BB BL	20	2669130000
ATPG 1.5-10 L	0.2 A 50	1991890000
ATPG 2.5 MI-R	0.2 A 50	1991960000
ATPG 2.5/3	0.2 A 25	2041190000
ATPG 2.5/5	0.2 A 25	2041180000
PS 2.0 MC	20	0310000000
SDIL 0,6X3,5X100	1	2749140000
SSCH 10X3X1000 CU/SN	140 A 1	0348900000
DEK 5/5 PLUS MC NE WS	1000	1854490000
DEK 5/5 MM WS	800	2007110000



Building installation wiring
PUSH IN connection

Application range



Width/Height/Depth	mm
Rated current / max. cond. cross-section	A/mm ²
Max. clamping range	mm ²

Technical data

Rated data	
Rated voltage	V
max. current	A
for wire cross-section	mm ²
Rated impulse withstand voltage / Pollution severity	
Gauge to IEC 60947-1 / UL 94 flammability rating	
Approvals	
Clamped conductors (H05V/H07V)	
Solid / Stranded	mm ²
Flexible / Flexible with ferrule	mm ²
Twin wire-end ferrule	mm ²
Stripping length / Blade size	mm/-
Rated voltage	
Rated voltage (L / L)	V
Rated voltage (L / N)	V
Rated voltage (L / PE)	V

Note

Ordering data

Version	dark beige
Note	

Accessories

Plug-in cross-connection	
	2-pole
	3-pole
	4-pole
	10-pole
End plate	dark beige
Support bracket for 10 x 3 (required every 20 cm)	
	blue
	blue, incl. metal holder for the busbar
End bracket	
	dark beige, direct mounting
	blue
	blue
Test adapter	
	1-pole
	stackable
	3-pole
	5-pole
Test plug	
Screwdriver	
	Standard
Busbar 10 x 3 (140 A)	
Marking tags	
For detailed information on other accessories and application in the online catalogue	

AITB 2.5 BB LL-PE

2.5 mm²



5.1 x 103 x 50.1	
24 / 4	
0.14...4	

IEC 60947-7-1 (-7-2)

IEC	UL	CSA	EN 60079-7
250			
27			
2.5			
	4 kV / 3		
	A3 / V-0		

CE

Rated connection	
	0.5...4 / 0.5...4
	0.5...4 / 0.5...2.5
	0.5...0.75
	10 / 0.6 x 3.5 mm
Rated voltage	
	400
	250
	250

Type	Qty.	Order No.
AITB 2.5 BB LL-PE	50	2668930000

Type	Qty.	Order No.
ZQV 2.5N/2	24 A 60	1527540000
ZQV 2.5N/3	24 A 60	1527570000
ZQV 2.5N/4	24 A 60	1527590000
ZQV 2.5N/10	24 A 20	1527690000
AEP ITB 2.5 BB	20	2668960000
APP ITB 2.5 BB BL	20	2668970000
APP ITB 2.5 BB BL VI		2881640000
AEB 35 SCL/1 VO	20	2661280000
AEB ITB 2.5/4 BB BL	25	2690440000
AEB ITB 16 BB BL	20	2669130000
ATPG 1.5-10 L	0.2 A 50	1991890000
ATPG 2.5 MHR	0.2 A 50	1991960000
ATPG 2.5/3	0.2 A 25	2041190000
ATPG 2.5/5	0.2 A 25	2041180000
PS 2.0 MC	20	0310000000
SDIL 0,6X3,5X100	1	2749140000
SSCH 10X3X1000 CU/SN	140 A 1	0348900000
DEK 5/5 PLUS MC NE WS	1000	1854490000
DEK 5/5 MM WS	800	2007110000

AITB 2.5 BB NDT-L-PE

2.5 mm²

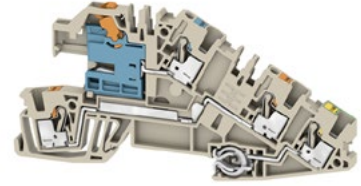

5.1 x 103 x 50.1	
24 / 4	
0.14...4	

In accordance with IEC 60947-7-1, In accordance with IEC 60947-7-2

IEC	UL	CSA	EN 60079-7
250			
27			
2.5			
	4 kV / 3		
	A3 / V-0		

CE

Rated connection	
	0.5...4 / 0.5...4
	0.5...4 / 0.5...2.5
	0.5...0.75
	10 / 0.6 x 3.5 mm
Rated voltage	
	400
	250
	250

Type	Qty.	Order No.
AITB 2.5 BB NDT-L-PE	50	2668950000

Type	Qty.	Order No.
ZQV 2.5N/2	24 A 60	1527540000
ZQV 2.5N/3	24 A 60	1527570000
ZQV 2.5N/4	24 A 60	1527590000
ZQV 2.5N/10	24 A 20	1527690000
AEP ITB 2.5 BB	20	2668960000
APP ITB 2.5 BB BL	20	2668970000
APP ITB 2.5 BB BL VI		2881640000
AEB 35 SCL/1 VO	20	2661280000
AEB ITB 2.5/4 BB BL	25	2690440000
AEB ITB 16 BB BL	20	2669130000
ATPG 1.5-10 L	0.2 A 50	1991890000
ATPG 2.5 MHR	0.2 A 50	1991960000
ATPG 2.5/3	0.2 A 25	2041190000
ATPG 2.5/5	0.2 A 25	2041180000
PS 2.0 MC	20	0310000000
SDIL 0,6X3,5X100	1	2749140000
SSCH 10X3X1000 CU/SN	140 A 1	0348900000
DEK 5/5 PLUS MC NE WS	1000	1854490000
DEK 5/5 MM WS	800	2007110000

AITB 2.5 BB L-L

2.5 mm²



5.1 x 103 x 50.1
24 / 4
0.14...4



IEC 60947-7-1

IEC	UL	CSA	EN 60079-7
400			
27			
2.5			
		4 kV / 3	
		A3 / V-0	

CE

Rated connection

0.5...4 / 0.5...4
0.5...4 / 0.5...2.5
0.5...0.75
10 / 0.6 x 3.5 mm

400
250
250

Type	Qty.	Order No.
AITB 2.5 BB L-L	50	2668900000

Type	Qty.	Order No.
ZQV 2.5N/2	24 A 60	1527540000
ZQV 2.5N/3	24 A 60	1527570000
ZQV 2.5N/4	24 A 60	1527590000
ZQV 2.5N/10	24 A 20	1527690000
AEP ITB 2.5 BB	20	2668960000
APP ITB 2.5 BB BL	20	2668970000
APP ITB 2.5 BB BL VI		2881640000
AEB 35 SCL/1 V0	20	2661280000
AEB ITB 2.5/4 BB BL	25	2690440000
AEB ITB 16 BB BL	20	2669130000
ATPG 1.5-10 L	0.2 A 50	1991890000
ATPG 2.5 MI-R	0.2 A 50	1991960000
ATPG 2.5/3	0.2 A 25	2041190000
ATPG 2.5/5	0.2 A 25	2041180000
PS 2.0 MC	20	0310000000
SDIL 0,6X3,5X100	1	2749140000
SSCH 10X3X1000 CU/SN	140 A 1	0348900000
DEK 5/5 PLUS MC NE WS	1000	1854490000
DEK 5/5 MM WS	800	2007110000





AITB 4 BB L-L-PE

4 mm²



6.1 x 110.2 x 53.2
30 / 6
0.14...6

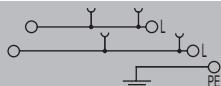

AITB 4 BB L-L

4 mm²



6.1 x 110.2 x 53.2
30 / 6
0.14...6

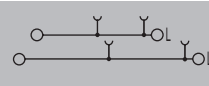

Width/Height/Depth mm
Rated current / max. cond. cross-section A/mm²
Max. clamping range mm²

Technical data

Rated data	
Rated voltage	V
max. current	A
for wire cross-section	mm ²
Rated impulse withstand voltage / Pollution severity	
Gauge to IEC 60947-1 / UL 94 flammability rating	
Approvals	
Clamped conductors (H05V/H07V)	
Solid / Stranded	mm ²
Flexible / Flexible with ferrule	mm ²
Twin wire-end ferrule	mm ²
Stripping length / Blade size	mm/-
Rated voltage	
Rated voltage (L / L)	V
Rated voltage (L / N)	V
Rated voltage (L / PE)	V
Note	

IEC 60947-7-1 (-7-2)

IEC	UL	CSA	EN 60079-7
250			
36			
4			
		4 kV / 3	
		A4 / V-0	
Rated connection			
0.5...6 / 0.5...6			
0.5...6 / 0.5...4			
0.5...1.5			
12 / 0.6 x 3.5 mm			
Rated voltage			
400			
250			
250			
Note			

IEC 60947-7-1

IEC	UL	CSA	EN 60079-7
400			
36			
4			
		4 kV / 3	
		A4 / V-0	
Rated connection			
0.5...6 / 0.5...6			
0.5...6 / 0.5...4			
0.5...1.5			
12 / 0.6 x 3.5 mm			
Rated voltage			
400			
250			
250			
Note			

Ordering data

Version
Note

Type	Qty.	Order No.
AITB 4 BB L-L-PE	25	2669080000

Type	Qty.	Order No.
AITB 4 BB L-L	25	2669070000

Accessories

Plug-in cross-connection	
	2-pole
	3-pole
	4-pole
	10-pole
End plate	
	dark beige
Support bracket for 10 x 3 (required every 20 cm)	
	blue
	blue, incl. metal holder for the busbar
End bracket	
	dark beige, direct mounting
	blue
	blue
Test adapter	
	1-pole
	stackable
Test plug	
Screwdriver	
	Standard
Busbar 10 x 3 (140 A)	
Marking tags	
For detailed information on other accessories and application in the online catalogue	

Type	Qty.	Order No.
ZQV 4N/2	32 A 60	1527930000
ZQV 4N/3	32 A 60	1527940000
ZQV 4N/4	32 A 60	1527970000
ZQV 4N/10	32 A 20	1528090000
AEP ITB 4 BB	20	2669110000
APP ITB 4 BB BL	20	2669120000
APP ITB 4 BB BL VI		2881650000
AEB 35 SCL/1 VO	20	2661280000
AEB ITB 2.5/4 BB BL	25	2690440000
AEB ITB 16 BB BL	20	2669130000
ATPG 1.5-10 L	0.2 A 50	1991890000
ATPG 4 M-R	0.2 A 50	1991860000
PS 2.0 MC	20	0310000000
SDIL 0,6X3,5X100	1	2749140000
SSCH 10X3X1000 CU/SN	140 A 1	0348900000
DEK 5/5 PLUS MC NE WS	1000	1854490000
WS 8/6 PLUS MC NE WS	600	1951880000
DEK 5/6 MM WS	600	2007120000

Type	Qty.	Order No.
ZQV 4N/2	32 A 60	1527930000
ZQV 4N/3	32 A 60	1527940000
ZQV 4N/4	32 A 60	1527970000
ZQV 4N/10	32 A 20	1528090000
AEP ITB 4 BB	20	2669110000
APP ITB 4 BB BL	20	2669120000
APP ITB 4 BB BL VI		2881650000
AEB 35 SCL/1 VO	20	2661280000
AEB ITB 2.5/4 BB BL	25	2690440000
AEB ITB 16 BB BL	20	2669130000
ATPG 1.5-10 L	0.2 A 50	1991890000
ATPG 4 M-R	0.2 A 50	1991860000
PS 2.0 MC	20	0310000000
SDIL 0,6X3,5X100	1	2749140000
SSCH 10X3X1000 CU/SN	140 A 1	0348900000
DEK 5/5 PLUS MC NE WS	1000	1854490000
WS 8/6 PLUS MC NE WS	600	1951880000
DEK 5/6 MM WS	600	2007120000

AITB 4 BB NDT-L-PE

4 mm²



6.1 x 110.2 x 53.2
30 / 6
0.14...6

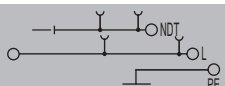

In accordance with IEC 60947-7-1, in accordance with IEC 60947-7-2

IEC	UL	CSA	EN 60079-7
250			
36			
4			
4 kV / 3			
A4 / V-0			

Rated connection	
0.5...6 / 0.5...6	
0.5...6 / 0.5...4	
0.5...1.5	
12 / 0.6 x 3.5 mm	
400	
250	
250	

Type	Qty.	Order No.
AITB 4 BB NDT-L-PE	25	2669100000

Type	Qty.	Order No.
ZQV 4N/2	32 A 60	1527930000
ZQV 4N/3	32 A 60	1527940000
ZQV 4N/4	32 A 60	1527970000
ZQV 4N/10	32 A 20	1528090000
AEP ITB 4 BB	20	2669110000
APP ITB 4 BB BL	20	2669120000
APP ITB 4 BB BL VI		2881650000
AEB 35 SCL/1 VO	20	2661280000
AEB ITB 2.5/4 BB BL	25	2690440000
AEB ITB 16 BB BL	20	2669130000
ATPG 1.5-10 L	0.2 A 50	1991890000
ATPG 4 M-R	0.2 A 50	1991860000
PS 2.0 MC	20	0310000000
SDIL 0,6X3,5X100	1	2749140000
SSCH 10X3X1000 CU/SN	140 A 1	0348900000
DEK 5/5 PLUS MC NE WS	1000	1854490000
WS 8/6 PLUS MC NE WS	600	1951880000
DEK 5/6 MM WS	600	2007120000

AITB 4 BB N-L-PE

4 mm²



6.1 x 110.2 x 53.2
30 / 6
0.14...6

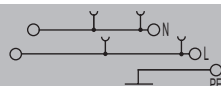

IEC 60947-7-1 (-7-2)

IEC	UL	CSA	EN 60079-7
250			
36			
4			
4 kV / 3			
A4 / V-0			

Rated connection	
0.5...6 / 0.5...6	
0.5...6 / 0.5...4	
0.5...1.5	
12 / 0.6 x 3.5 mm	
400	
250	
250	

Type	Qty.	Order No.
AITB 4 BB N-L-PE	25	2669090000

Type	Qty.	Order No.
ZQV 4N/2	32 A 60	1527930000
ZQV 4N/3	32 A 60	1527940000
ZQV 4N/4	32 A 60	1527970000
ZQV 4N/10	32 A 20	1528090000
AEP ITB 4 BB	20	2669110000
APP ITB 4 BB BL	20	2669120000
APP ITB 4 BB BL VI		2881650000
AEB 35 SCL/1 VO	20	2661280000
AEB ITB 2.5/4 BB BL	25	2690440000
AEB ITB 16 BB BL	20	2669130000
ATPG 1.5-10 L	0.2 A 50	1991890000
ATPG 4 M-R	0.2 A 50	1991860000
PS 2.0 MC	20	0310000000
SDIL 0,6X3,5X100	1	2749140000
SSCH 10X3X1000 CU/SN	140 A 1	0348900000
DEK 5/5 PLUS MC NE WS	1000	1854490000
WS 8/6 PLUS MC NE WS	600	1951880000
DEK 5/6 MM WS	600	2007120000



Building installation wiring
PUSH IN connection



Width/Height/Depth	mm
Rated current / max. cond. cross-section	A/mm ²
Max. clamping range	mm ²

Technical data

Rated data	
Rated voltage	V
Rated current	A
for wire cross-section	mm ²
Rated impulse withstand voltage / Pollution severity	
Gauge to IEC 60947-1 / UL 94 flammability rating	
Approvals	
Clamped conductors (H05V/H07V)	
Solid / Stranded	mm ²
Flexible / Flexible with ferrule	mm ²
Twin wire-end ferrule	mm ²
Stripping length / Blade size	mm/-
Rated voltage	
Rated voltage (L / L)	V
Rated voltage (L / N)	V
Rated voltage (L / PE)	V
Note	

Ordering data

Version	dark beige
Note	

Accessories

Plug-in cross-connection	
	2-pole
	3-pole
	4-pole
	10-pole
End plate	
	dark beige
End bracket	
	dark beige, direct mounting
	blue
	blue
Test adapter	
	1-pole
	stackable
Screwdriver	
	Standard
Holder for cartridge fuse 5 x 20 mm	
	400 V AC/DC, without LED
	10 - 36 V AC/DC, red LED
	140 - 250 V AC/DC, red LED
Module connector (max. 250 V)	
	without fittings
	with wire jumper
	With 1N4007 diode
Disconnect plug	
	orange
Marking tags	
For detailed information on other accessories and application in the online catalogue	

AITB 2.5 LDT-L

2.5 mm²



5.1 x 103 x 50.1
24 / 4
0.14...4

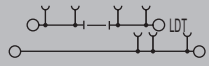

IEC 60947-7-1

IEC	UL	CSA	EN 60079-7
400	300	300	
24	20	20	
2.5	AWG 26...12	AWG 26...12	
4 kV / 3			
A3 / V-0			

CE e-PA

Rated connection	
	0.5...4 / 0.5...4
	0.5...4 / 0.5...2.5
	0.5...0.75
	10 / 0.6 x 3.5 mm

400
250
250

Type	Qty.	Order No.
AITB 2.5 LDT-L	50	2668980000

Type	Qty.	Order No.
ZQV 2.5N/2	24 A 60	1527540000
ZQV 2.5N/3	24 A 60	1527570000
ZQV 2.5N/4	24 A 60	1527590000
ZQV 2.5N/10	24 A 20	1527690000

AEP ITB 2.5	20	2669060000
AEB 35 SCL/1 V0	20	2661280000
AEB ITB 2.5/4 BB BL	25	2690440000
AEB ITB 16 BB BL	20	2669130000

ATPG 1.5-10 L	0.2 A 50	1991890000
ATPG 2.5 MHR	0.2 A 50	1991960000
SDIL 0,6X3,5X100	1	2749140000

SIHA 3/G20	6.3 A 25	7921560000
SIHA 3/G20/LD 10-36V	25	7921570000
SIHA 3/G20/LD 140-250V	25	7921600000

BEST	50	1833100000
BEST/DRBR	22 A 50	1878570000
BEST/D	1 A 50	1878560000

TNST OR	20 A 50	2463540000
---------	---------	------------

DEK 5/5 PLUS MC NE WS	1000	1854490000
DEK 5/5 MM WS	800	2007110000

AITB 2.5 LDT-L-PE

2.5 mm²



5.1 x 103 x 50.1
24 / 4
0.14...4



IEC 60947-7-1 (-7-2)

IEC	UL	CSA	EN 60079-7
250	300	300	
24	20	20	
2.5	AWG 26...12	AWG 26...12	
4 kV / 3			
A3 / V-0			

CE e-PA

Rated connection	
	0.5...4 / 0.5...4
	0.5...4 / 0.5...2.5
	0.5...0.75
	10 / 0.6 x 3.5 mm

400
250
250

Type	Qty.	Order No.
AITB 2.5 LDT-L-PE	50	2669040000

Type	Qty.	Order No.
ZQV 2.5N/2	24 A 60	1527540000
ZQV 2.5N/3	24 A 60	1527570000
ZQV 2.5N/4	24 A 60	1527590000
ZQV 2.5N/10	24 A 20	1527690000

AEP ITB 2.5	20	2669060000
AEB 35 SCL/1 V0	20	2661280000
AEB ITB 2.5/4 BB BL	25	2690440000
AEB ITB 16 BB BL	20	2669130000

ATPG 1.5-10 L	0.2 A 50	1991890000
ATPG 2.5 MHR	0.2 A 50	1991960000
SDIL 0,6X3,5X100	1	2749140000

SIHA 3/G20	6.3 A 25	7921560000
SIHA 3/G20/LD 10-36V	25	7921570000
SIHA 3/G20/LD 140-250V	25	7921600000

BEST	50	1833100000
BEST/DRBR	22 A 50	1878570000
BEST/D	1 A 50	1878560000

TNST OR	20 A 50	2463540000
---------	---------	------------

DEK 5/5 PLUS MC NE WS	1000	1854490000
DEK 5/5 MM WS	800	2007110000

AITB 2.5 NDT-L-PE

2.5 mm²



5.1 x 103 x 50.1
24 / 4
0.14...4

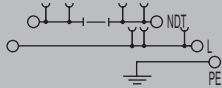

IEC 60947-7-1 (-7-2)

IEC	UL	CSA	EN 60079-7
250	300	300	
24	20	20	
2.5	AWG 26...12	AWG 26...12	
4 kV / 3			
A3 / V-0			



Rated connection

0.5...4 / 0.5...4
0.5...4 / 0.5...2.5
0.5...0.75
10 / 0.6 x 3.5 mm

400
250
250

Type	Qty.	Order No.
AITB 2.5 NDT-L-PE	50	2669030000

Type	Qty.	Order No.
ZQV 2.5N/2	24 A 60	1527540000
ZQV 2.5N/3	24 A 60	1527570000
ZQV 2.5N/4	24 A 60	1527590000
ZQV 2.5N/10	24 A 20	1527690000
AEP ITB 2.5	20	2669060000
AEB 35 SCL/1 V0	20	2661280000
AEB ITB 2.5/4 BB BL	25	2690440000
AEB ITB 16 BB BL	20	2669130000
ATPG 1.5-10 L	0.2 A 50	1991890000
ATPG 2.5 MI-R	0.2 A 50	1991960000
SDIL 0,6X3,5X100	1	2749140000
SIHA 3/G20	6.3 A 25	7921560000
SIHA 3/G20/LD 10-36V	25	7921570000
SIHA 3/G20/LD 140-250V	25	7921600000
BEST	50	1833100000
BEST/DRBR	22 A 50	1878570000
BEST/D	1 A 50	1878560000
TNST OR	20 A 50	2463540000
DEK 5/5 PLUS MC NE WS	1000	1854490000
DEK 5/5 MM WS	800	2007110000

AITB 2.5 LDT-L W/O DTLV

2.5 mm²



5.1 x 103 x 50.1
24 / 4
0.14...4

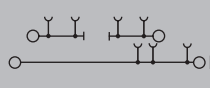

IEC 60947-7-1

IEC	UL	CSA	EN 60079-7
400	300	300	
24	20	20	
2.5	AWG 26...12	AWG 26...12	
4 kV / 3			
A3 / V-0			



Rated connection

0.5...4 / 0.5...4
0.5...4 / 0.5...2.5
0.5...0.75
10 / 0.6 x 3.5 mm

400
250
250

Type	Qty.	Order No.
AITB 2.5 LDT-L W/O DTLV without separator	50	2668990000

Type	Qty.	Order No.
ZQV 2.5N/2	24 A 60	1527540000
ZQV 2.5N/3	24 A 60	1527570000
ZQV 2.5N/4	24 A 60	1527590000
ZQV 2.5N/10	24 A 20	1527690000
AEP ITB 2.5	20	2669060000
AEB 35 SCL/1 V0	20	2661280000
AEB ITB 2.5/4 BB BL	25	2690440000
AEB ITB 16 BB BL	20	2669130000
ATPG 1.5-10 L	0.2 A 50	1991890000
ATPG 2.5 MI-R	0.2 A 50	1991960000
SDIL 0,6X3,5X100	1	2749140000
SIHA 3/G20	6.3 A 25	7921560000
SIHA 3/G20/LD 10-36V	25	7921570000
SIHA 3/G20/LD 140-250V	25	7921600000
BEST	50	1833100000
BEST/DRBR	22 A 50	1878570000
BEST/D	1 A 50	1878560000
TNST OR	20 A 50	2463540000
DEK 5/5 PLUS MC NE WS	1000	1854490000
DEK 5/5 MM WS	800	2007110000

AITB 2.5 LDT-L-PE W/O DTLV

2.5 mm²



5.1 x 103 x 50.1
24 / 4
0.14...4

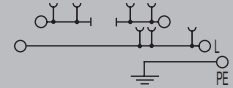

IEC 60947-7-1 (-7-2)

IEC	UL	CSA	EN 60079-7
250	300	300	
24	20	20	
2.5	AWG 26...12	AWG 26...12	
4 kV / 3			
A3 / V-0			



Rated connection

0.5...4 / 0.5...4
0.5...4 / 0.5...2.5
0.5...0.75
10 / 0.6 x 3.5 mm

400
250
250

Type	Qty.	Order No.
AITB 2.5 LDT-L-PE W/O DTLV without separator	50	2669050000

Type	Qty.	Order No.
ZQV 2.5N/2	24 A 60	1527540000
ZQV 2.5N/3	24 A 60	1527570000
ZQV 2.5N/4	24 A 60	1527590000
ZQV 2.5N/10	24 A 20	1527690000
AEP ITB 2.5	20	2669060000
AEB 35 SCL/1 V0	20	2661280000
AEB ITB 2.5/4 BB BL	25	2690440000
AEB ITB 16 BB BL	20	2669130000
ATPG 1.5-10 L	0.2 A 50	1991890000
ATPG 2.5 MI-R	0.2 A 50	1991960000
SDIL 0,6X3,5X100	1	2749140000
SIHA 3/G20	6.3 A 25	7921560000
SIHA 3/G20/LD 10-36V	25	7921570000
SIHA 3/G20/LD 140-250V	25	7921600000
BEST	50	1833100000
BEST/DRBR	22 A 50	1878570000
BEST/D	1 A 50	1878560000
TNST OR	20 A 50	2463540000
DEK 5/5 PLUS MC NE WS	1000	1854490000
DEK 5/5 MM WS	800	2007110000



Width/Height/Depth	mm
Rated current / max. cond. cross-section	A/mm ²
Max. clamping range	mm ²

Technical data

Rated data	
Rated voltage	V
Rated current	A
for wire cross-section	mm ²
Rated impulse withstand voltage / Pollution severity	
Gauge to IEC 60947-1 / UL 94 flammability rating	
Approvals	
Clamped conductors (H05V/H07V)	
Solid / Stranded	mm ²
Flexible / Flexible with ferrule	mm ²
Twin wire-end ferrule	mm ²
Stripping length / Blade size	mm/-
Rated voltage	
Rated voltage (L / L)	V
Rated voltage (L / N)	V
Rated voltage (L / PE)	V

Note

Ordering data

Version	dark beige
Note	

Accessories

Plug-in cross-connection	
	2-pole
	3-pole
	4-pole
	10-pole
End plate	
	dark beige
End bracket	
	dark beige, direct mounting
	blue
	blue
Test adapter	
	1-pole
	stackable
Screwdriver	
	Standard
Holder for cartridge fuse 5 x 20 mm	
	400 V AC/DC, without LED
	10 - 36 V AC/DC, red LED
	140 - 250 V AC/DC, red LED
Module connector (max. 250 V)	
	without fittings
	with wire jumper
	With 1N4007 diode
Disconnect plug	
	orange
Marking tags	
For detailed information on other accessories and application in the online catalogue	

AITB 2.5 L-L-PE

2.5 mm²



5.1 x 103 x 50.1	
24 / 4	
0.14...4	

IEC 60947-7-1 (-7-2)

IEC	UL	CSA	EN 60079-7
250	300	300	
24	20	20	
2.5	AWG 26...12	AWG 26...12	
4 kV / 3			
A3 / V-0			

CE CB e-PA

Rated connection	
	0.5...4 / 0.5...4
	0.5...4 / 0.5...2.5
	0.5...0.75
	10 / 0.6 x 3.5 mm

400	
250	
250	

Type	Qty.	Order No.
AITB 2.5 L-L-PE	50	2669010000

Type	Qty.	Order No.
ZQV 2.5N/2	24 A 60	1527540000
ZQV 2.5N/3	24 A 60	1527570000
ZQV 2.5N/4	24 A 60	1527590000
ZQV 2.5N/10	24 A 20	1527690000
AEP ITB 2.5	20	2669060000
AEB 35 SCL/1 V0	20	2661280000
AEB ITB 2.5/4 BB BL	25	2690440000
AEB ITB 16 BB BL	20	2669130000
ATPG 1.5-10 L	0.2 A 50	1991890000
ATPG 2.5 MHR	0.2 A 50	1991960000
SDIL 0,6X3,5X100	1	2749140000
SIHA 3/G20	6.3 A 25	7921560000
SIHA 3/G20/LD 10-36V	25	7921570000
SIHA 3/G20/LD 140-250V	25	7921600000
BEST	50	1833100000
BEST/DRBR	22 A 50	1878570000
BEST/D	1 A 50	1878560000
TNST OR	20 A 50	2463540000
DEK 5/5 PLUS MC NE WS	1000	1854490000
DEK 5/5 MM WS	800	2007110000

AITB 2.5 N-L-PE

2.5 mm²



5.1 x 103 x 50.1	
24 / 4	
0.14...4	

IEC 60947-7-1 (-7-2)

IEC	UL	CSA	EN 60079-7
250	300	300	
24	20	20	
2.5	AWG 26...12	AWG 26...12	
4 kV / 3			
A3 / V-0			

CE CB e-PA

Rated connection	
	0.5...4 / 0.5...4
	0.5...4 / 0.5...2.5
	0.5...0.75
	10 / 0.6 x 3.5 mm

400	
250	
250	

Type	Qty.	Order No.
AITB 2.5 N-L-PE	50	2669020000

Type	Qty.	Order No.
ZQV 2.5N/2	24 A 60	1527540000
ZQV 2.5N/3	24 A 60	1527570000
ZQV 2.5N/4	24 A 60	1527590000
ZQV 2.5N/10	24 A 20	1527690000
AEP ITB 2.5	20	2669060000
AEB 35 SCL/1 V0	20	2661280000
AEB ITB 2.5/4 BB BL	25	2690440000
AEB ITB 16 BB BL	20	2669130000
ATPG 1.5-10 L	0.2 A 50	1991890000
ATPG 2.5 MHR	0.2 A 50	1991960000
SDIL 0,6X3,5X100	1	2749140000
SIHA 3/G20	6.3 A 25	7921560000
SIHA 3/G20/LD 10-36V	25	7921570000
SIHA 3/G20/LD 140-250V	25	7921600000
BEST	50	1833100000
BEST/DRBR	22 A 50	1878570000
BEST/D	1 A 50	1878560000
TNST OR	20 A 50	2463540000
DEK 5/5 PLUS MC NE WS	1000	1854490000
DEK 5/5 MM WS	800	2007110000

AITB 2.5 L-L

2.5 mm²



5.1 x 103 x 50.1
24 / 4
0.14...4

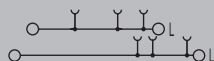

IEC 60947-7-1

IEC	UL	CSA	EN 60079-7
400	300	300	
24	20	20	
2.5	AWG 26...12	AWG 26...12	
4 kV / 3			
A3 / V-0			

CE

Rated connection

0.5...4 / 0.5...4

0.5...4 / 0.5...2.5

0.5...0.75

10 / 0.6 x 3.5 mm

400

250

250

Type	Qty.	Order No.
AITB 2.5 L-L	50	2669000000

Type	Qty.	Order No.
ZQV 2.5N/2	24 A 60	1527540000
ZQV 2.5N/3	24 A 60	1527570000
ZQV 2.5N/4	24 A 60	1527590000
ZQV 2.5N/10	24 A 20	1527690000
AEP ITB 2.5	20	2669060000
AEB 35 SCL/1 V0	20	2661280000
AEB ITB 2.5/4 BB BL	25	2690440000
AEB ITB 16 BB BL	20	2669130000
ATPG 1.5-10 L	0.2 A 50	1991890000
ATPG 2.5 MI-R	0.2 A 50	1991960000
SDIL 0,6X3,5X100	1	2749140000
SIHA 3/G20	6.3 A 25	7921560000
SIHA 3/G20/LD 10-36V	25	7921570000
SIHA 3/G20/LD 140-250V	25	7921600000
BEST	50	1833100000
BEST/DRBR	22 A 50	1878570000
BEST/D	1 A 50	1878560000
TNST OR	20 A 50	2463540000
DEK 5/5 PLUS MC NE WS	1000	1854490000
DEK 5/5 MM WS	800	2007110000





Klippon® Connect for building installation wiring

Sophisticated and uniform accessoires

Safe and flexible covering of live components

The BB-CV AITB 3X10 cover profile provides the necessary finger safety within the switchgear. Protruding parts of the busbar, which are provided as a reserve within the switchgear, can thus be protected against unintentional contact. The cover profile can be flexibly and individually cut to length.

Cover profile	BB-CV			
	Type	Length	Qty.	Order No.
	BB-CV AITB 3X10	300 mm	10	2911380000
	BB-CV AITB 3X10 BL	300 mm	10	2918930000

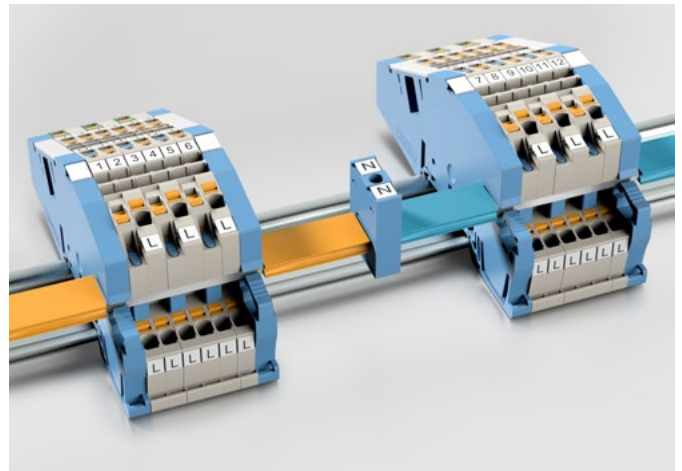

End bracket, support block and end plate cleverly combined in one product

The AEB ITB 2.5/4 BB BL is one of the all-rounders in the Klippon® Connect accessories for building installation wiring. The end bracket serves as a support block for the busbar. Due to its identical contour to the 3-level installation terminal blocks AITB 2.5 BB... it could also be used as a visual demarcation within the terminal strip, but also as an end plate. This saves additional components and working time. A receptacle for the terminal strip labelling (WAD 5) is available on the head side of the products.

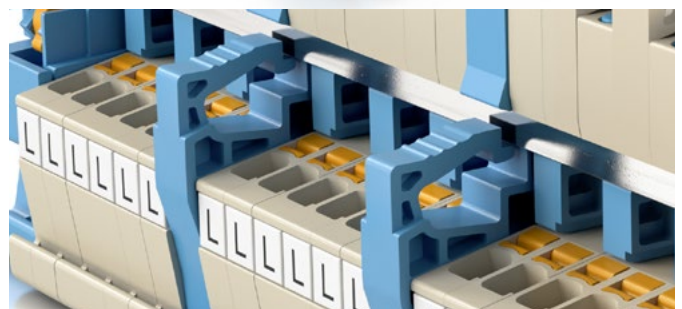
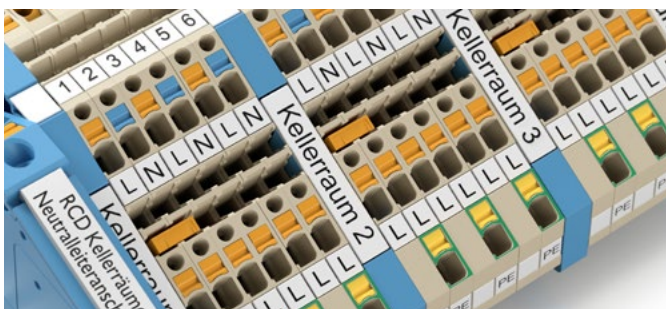
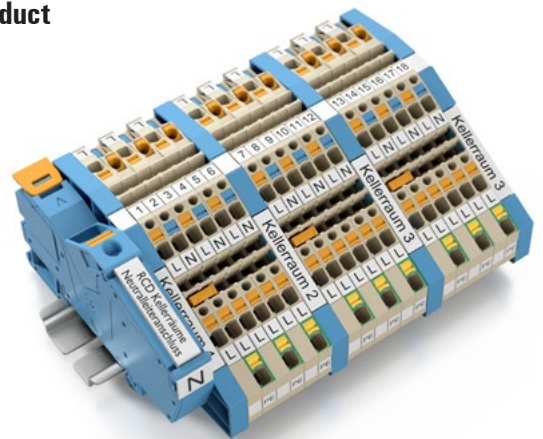

Clean and clear distinction of internal and external wiring within the cabinet

With the AITB 16 BB NLO, the neutral conductor busbar is integrated into the system quickly, safely and without any additional tools. As with the installation terminal blocks, the internal wiring in the control cabinet is carried out in the direction of the busbar. This creates a clear visual distinction between internal wiring at the switchgear manufacturer and external wiring on the construction site. The AEB ITB 16 BB BL, without connection function for a conductor, completes the portfolio.

Both versions have integrated the function of an support block in addition to the function of an end bracket. This saves additional components and working time. A plug-in possibility for terminal strip labelling (WAD 5 or WAD 8) is available on the head side of the products.

For finger safety at the end of the DIN-Rail, an integrated end plate could be broken out of the front area of the product. This can be attached on the left or right side, depending on the structure of the terminal strip. Both product variants are supplied with an integrated end plate for the product as well as for the busbar.

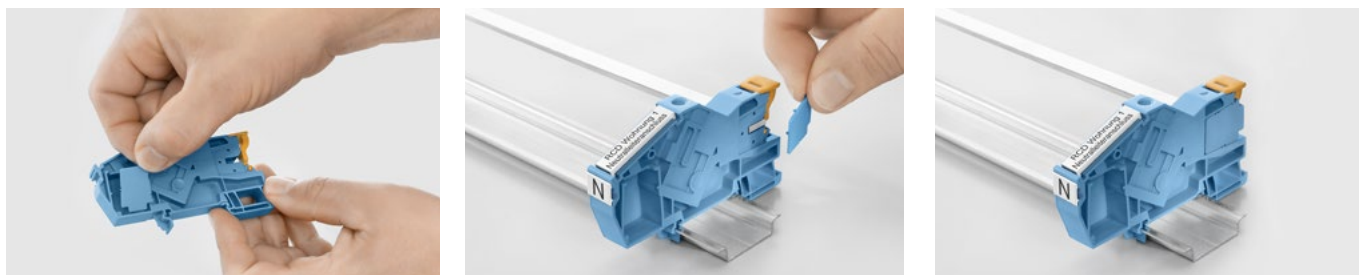

AITB 16 BB NLO

16 mm²

AEB ITB 16 BB BL

AEB ITB 2.5/4 BB BL



Dimensions	
Width/Height/Depth	mm
Continuous operating temp., min.	
Continuous operating temp., max.	
Material	
Rated data	
Rated voltage	V
Rated current	A
Rated impulse withstand voltage / Pollution severity	
Gauge to IEC 60947-1 / UL 94 flammability rating	
Clamped conductors (H05V/H07V)	
Solid / Stranded	mm ²
Flexible / Flexible with ferrule	mm ²
Stripping length / Blade size	mm/-
Ordering data	
	blue
Note	

	91.15/52.9/12	
	-60 °C	
	130 °C	
	polyamide 66	
IEC	UL	CSA
	1000	
	65	
	8 kV / 3	
	A6 / V-0	
Clamped conductors (H05V/H07V)		
	0,5...16 / 0,5...16	
	0,5...16 / 0,5...16	
	18 / 1,0 x 5,5 mm	
Type	Qty.	Order No.
AITB 16 BB NLO	20	2669140000

	91.15/52.9/12	
	-60 °C	
	130 °C	
	polyamide 66	
IEC	UL	CSA
	/ 3	
	/ V-0	
Clamped conductors (H05V/H07V)		
Type	Qty.	Order No.
AEB ITB 16 BB BL	20	2669130000

	6.1 x 50.5 x 104	
	-60 °C	
	130 °C	
	polyamide 66	
IEC	UL	CSA
Type	Qty.	Order No.
AEB ITB 2.5/4 BB BL	25	2690440000



KNX-Bussystem simple and clear wiring

Klippon® Connect for smart electrical installation in buildings

Automation and growing data volumes are of increasing importance in building technology. Precise, unambiguous data wiring systems are thereby essential for efficient cabinet assembly.

The Klippon® Connect KNX-terminal blocks provide the wiring of the main and reserve leads for KNX Bus wiring systems within a 7 mm combined block width. At each level, a double cross-connection point yields quick and easy distribution of the potential within the terminal.

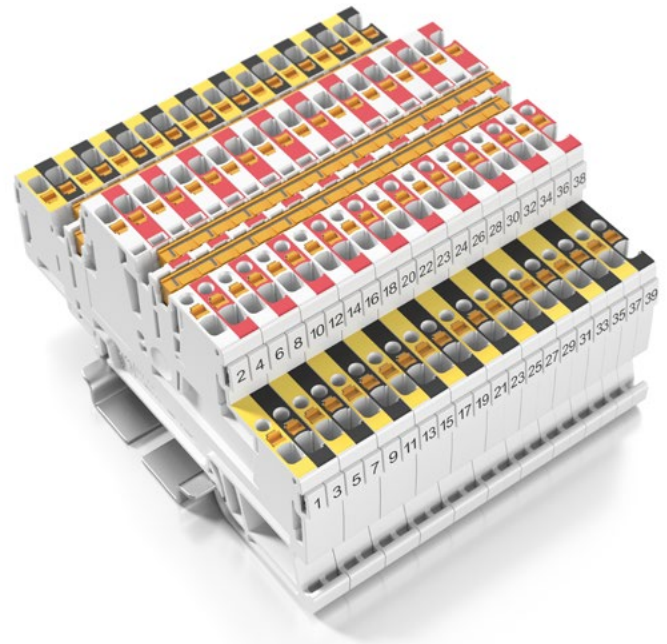

B Your special advantages:

- Numerous marking possibilities
- Colour coded terminals for each wire colour
- Standardised accessories
- Minimal space requirements thanks to 3.5 mm individual terminal width





A2T 1.5 KNX RD-BK

1.5 mm²

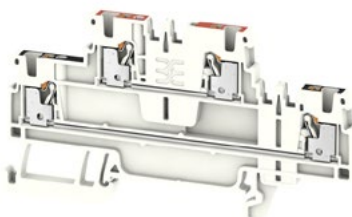

3.5 x 84 x 45
17.5 / 1.5
0.14...1.5



A2T 1.5 KNX WT-YL

1.5 mm²

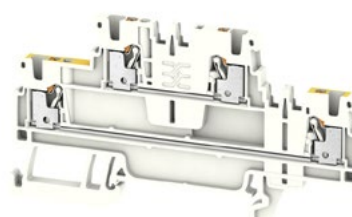

3.5 x 84 x 45
17.5 / 1.5
0.14...1.5



Width/Height/Depth mm
max. current / max. cond. cross-section A/mm²
Max. clamping range mm²

Technical data

Rated data	
Rated voltage	V
Rated current	A
for wire cross-section	mm ²
Rated impulse withstand voltage / Pollution severity	
Gauge to IEC 60947-1 / UL 94 flammability rating	
Approvals	
Clamped conductors (H05V/H07V)	
Solid / Stranded	mm ²
Flexible / Flexible with ferrule	mm ²
Twin wire-end ferrule	-
Stripping length / Blade size	mm/-

Note

Ordering data

Version	
	dark beige
Note	

Accessories

Plug-in cross-connection	
	2-pole
	10-pole
End plate	
	dark beige
	Blue
End bracket	
	dark beige, screwable
	dark beige, direct mounting
Test adapter	
	1-pole
	stackable
Test plug	
Screwdriver	
	Standard
Marking tags	

For detailed information on other accessories and application in the online catalogue

IEC 60947-7-1

IEC	UL	CSA	EN 60079-7
500			
17.5			
1.5			
		6 kV / 3	
		A1 / V-0	
Ⓢ Ⓢ Ⓢ Ⓢ			
Rated connection			
0.5...1.5 / 0.5...1.5			
0.5...1.5 / 0.5...1			
8 / 0.4 x 2.0 mm			

Type	Qty.	Order No.
A2T 1.5 KNX RD-BK	50	2652200000

Type	Qty.	Order No.
ZQV 1.5N/2	17.5 A 60	1985410000
ZQV 1.5N/10	17.5 A 20	1985580000
AEP 2T 1.5	20	2469420000
AEP 2T 1.5 BL	20	2471470000
AEB 35 SC/1	50	1991920000
AEB 35 SCL/1 VO	20	2661280000
ATPG 1.5-10 L	0.2 A 50	1991890000
ATPG 1.5 MHR	0.2 A 50	1991880000
PS 2.0 MC	20	0310000000
SDS 0.4X2.0X60	1	2749260000
WS 10/3.5 PLUS MC NE WS	960	2003760000
DEK 5/3.5 MM WS	1000	2007100000
DEK 5/3.5 PLUS MC NE WS	1600	2003750000

IEC 60947-7-1

IEC	UL	CSA	EN 60079-7
500			
17.5			
1.5			
		6 kV / 3	
		A1 / V-0	
Ⓢ Ⓢ Ⓢ Ⓢ			
Rated connection			
0.5...1.5 / 0.5...1.5			
0.5...1.5 / 0.5...1			
8 / 0.4 x 2.0 mm			

Type	Qty.	Order No.
A2T 1.5 KNX WT-YL	50	2652210000

Type	Qty.	Order No.
ZQV 1.5N/2	17.5 A 60	1985410000
ZQV 1.5N/10	17.5 A 20	1985580000
AEP 2T 1.5	20	2469420000
AEP 2T 1.5 BL	20	2471470000
AEB 35 SC/1	50	1991920000
AEB 35 SCL/1 VO	20	2661280000
ATPG 1.5-10 L	0.2 A 50	1991890000
ATPG 1.5 MHR	0.2 A 50	1991880000
PS 2.0 MC	20	0310000000
SDS 0.4X2.0X60	1	2749260000
WS 10/3.5 PLUS MC NE WS	960	2003760000
DEK 5/3.5 MM WS	1000	2007100000
DEK 5/3.5 PLUS MC NE WS	1600	2003750000





WNT 2.5

2.5 mm²

WNT 4

4 mm²

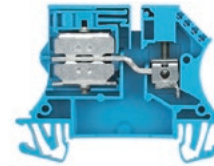
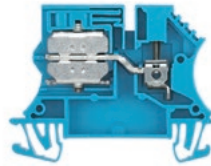

Width/Height/Depth	mm
max. current / max. cond. cross-section	A
Max. clamping range	mm ²

5.1 x 60 x 46.5	
32 / 4	NT
0.13...4	

6.1 x 60 x 46.5	
41 / 6	NT
0.13...6	

Technical data

Rated data	
Rated voltage	V
Rated current	A
for wire cross-section	mm ²
Rated impulse withstand voltage / Pollution severity	
Gauge to IEC 60947-1 / UL 94 flammability rating	
Approvals	
Clamped conductors (H05V/H07V)	
Solid / Stranded	mm ²
Flexible / Flexible with ferrule	mm ²
Tightening torque / Clamping screw	Nm
Tightening torque Separating screw	-
Stripping length / Blade size	mm/-

In accordance with IEC 60947-7-1

IEC	UL	CSA	EN 60079-7
400	600	600	
24	25	20	
2.5	AWG 26...12	AWG 26...12	
6 kV / 3			
A3 / V-0			

In accordance with IEC 60947-7-1

IEC	UL	CSA	EN 60079-7
400	600	600	
32	35	25	
4	AWG 26...10	AWG 26...10	
6 kV / 3			
A4 / V-0			

CE CB IEC UL CSA VDE

Rated connection

0.5...4 / 1.5...4
0.5...4
0.4...0.6 / (M 2.5)
10 / 0.6 x 3.5 mm

CE CB IEC UL CSA VDE

Rated connection

0.5...6 / 1.5...6
0.5...6
0.5...1 / (M 3)
10 / 0.6 x 3.5 mm

Note

Tightening torque, N-isolator 0.4...0.6 Nm

Tightening torque, N-isolator 0.4...0.8 Nm

Ordering data

Version	
	dark beige
	Blue
Note	

Type	Qty.	Order No.
WNT 2.5 10X3 BE	100	1010600000
WNT 2.5 10X3	100	1010680000

Type	Qty.	Order No.
WNT 4 10X3	100	1010780000

Accessories

End plate / Partition plate	dark beige
	Blue
Support bracket for 10 x 3 (required every 20 cm)	Blue
End bracket	dark beige
Screwdriver	With "swifty set" cutting device
	Standard
Busbar 10 x 3 (140 A)	
Clamping yoke for power supply to 10 x 3 busbars	Rigid / flexible 0.5 - 6 / 4 mm ²
	Rigid / flexible 6 - 16 mm ²
	flexible 16 - 35 mm ²
Marking tags	

Type	Qty.	Order No.
WAP 2.5-10	50	1050000000
WAP 2.5-10 BL	50	1050080000
WHP 2.5-35N/10X3 BL	20	1050280000
WEW 35/2	50	1061200000
SWIFTY SET	1	9006060000
SDS 0.6X3.5X100	1	2749340000
SSCH 10X3X1000 CU/SN	140 A	0348900000
ZB 4	50	0316500000
ZB 16 ZKSC	50	0316600000
ZB 35/M6X16	20	0266500000
DEK 5/5 MC NE WS	1000	1609801044
WS 12/5 MC NE WS	720	1609860000

Type	Qty.	Order No.
WAP 2.5-10	50	1050000000
WAP 2.5-10 BL	50	1050080000
WHP 2.5-35N/10X3 BL	20	1050280000
WEW 35/2	50	1061200000
SWIFTY SET	1	9006060000
SDS 0.6X3.5X100	1	2749340000
SSCH 10X3X1000 CU/SN	140 A	0348900000
ZB 4	50	0316500000
ZB 16 ZKSC	50	0316600000
ZB 35/M6X16	20	0266500000
DEK 5/5 MC NE WS	1000	1609801044
WS 12/5 MC NE WS	720	1609860000

For detailed information on other accessories and application in the online catalogue

For detailed information on other accessories and application in the online catalogue

WNT 6

6 mm²

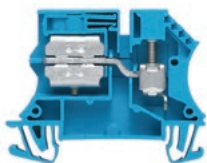

7.9 x 60 x 46.5
57 / 10
0.5...10

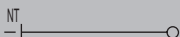

In accordance with IEC 60947-7-1

IEC	UL	CSA	EN 60079-7
400	600	600	
41	45	35	
6	AWG 20...8	AWG 26...8	
6 kV / 3			
A5 / V-0			



Rated connection

0.5...10 / 1.5...10
0.5...10
0.8...1.2 / (M 3.5)

12 / 4.0 x 0.8 mm

Tightening torque, N-isolator 0.8...1.6 Nm

Type	Qty.	Order No.
WNT 6 10X3	50	1010880000

Type	Qty.	Order No.	
WAP 2.5-10	50	1050000000	
WAP 2.5-10 BL	50	1050080000	
WHP 2.5-35N/10X3 BL	20	1050280000	
WEW 35/2	50	1061200000	
SWIFTY SET	1	9006060000	
SDS 0.6X3.5X100	1	2749340000	
SSCH 10X3X1000 CU/SN	140 A	1	0348900000
ZB 4	50	0316500000	
ZB 16 ZKSC	50	0316600000	
ZB 35/M6X16	20	0266500000	
DEK 5/5 MC NE WS	1000	1609801044	
WS 12/5 MC NE WS	720	1609860000	

WNT 10

10 mm²

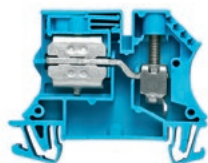

9.9 x 60 x 46.5
76 / 16
1.31...16

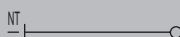

In accordance with IEC 60947-7-1

IEC	UL	CSA	EN 60079-7
400	600	600	
57	60	50	
10	AWG 16...8	AWG 16...6	
6 kV / 3			
B6 / V-0			



Rated connection

1.5...16 / 1.5...16
1.5...16
1.2...2 / (M 4)

12 / 1.0 x 5.5 mm

Tightening torque, N-isolator 0.8...1.6 Nm.

Type	Qty.	Order No.
WNT 10 10X3 BE	50	1010900000
WNT 10 10X3	50	1010980000

Type	Qty.	Order No.	
WAP 2.5-10	50	1050000000	
WAP 2.5-10 BL	50	1050080000	
WHP 2.5-35N/10X3 BL	20	1050280000	
WEW 35/2	50	1061200000	
SWIFTY SET	1	9006060000	
SDS 0.6X3.5X100	1	2749340000	
SSCH 10X3X1000 CU/SN	140 A	1	0348900000
ZB 4	50	0316500000	
ZB 16 ZKSC	50	0316600000	
ZB 35/M6X16	20	0266500000	
DEK 5/5 MC NE WS	1000	1609801044	
WS 12/5 MC NE WS	720	1609860000	

WNT 16N

16 mm²

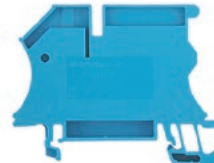

12 x 60 x 46.5
101 / 25
1.5...25

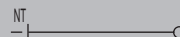

In accordance with IEC 60947-7-1

IEC	UL	CSA	EN 60079-7
400	300	300	
76	65	65	
16	AWG 14...6	AWG 14...6	
6 kV / 3			
B7 / V-0			



Rated connection

1.5...16 / 1.5...25
1.5...16
1.2...2.2 / (M 4)

12 / 1.0 x 5.5 mm

Tightening torque, N-isolator 0.8...1.6 Nm.

Type	Qty.	Order No.
WNT 16N 10X3	50	1019000000

Type	Qty.	Order No.	
WAP 2.5-10	50	1050000000	
WAP 2.5-10 BL	50	1050080000	
WHP 2.5-35N/10X3 BL	20	1050280000	
WEW 35/2	50	1061200000	
SWIFTY SET	1	9006060000	
SDS 0.6X3.5X100	1	2749340000	
SSCH 10X3X1000 CU/SN	140 A	1	0348900000
ZB 4	50	0316500000	
ZB 16 ZKSC	50	0316600000	
ZB 35/M6X16	20	0266500000	
DEK 5/5 MC NE WS	1000	1609801044	
WS 12/5 MC NE WS	720	1609860000	



Building installation wiring
Screw connection



WNT 35N

35 mm²

Compact design



Width/Height/Depth	mm
max. current / max. cond. cross-section	A
Max. clamping range	mm ²

16 x 66 x 50.5	
140 / 50	NT
2.5...50	

Technical data

Rated data	
Rated voltage	V
Rated current	A
for wire cross-section	mm ²
Rated impulse withstand voltage / Pollution severity	
Gauge to IEC 60947-1 / UL 94 flammability rating	
Approvals	
Clamped conductors (H05V/H07V)	
Solid / Stranded	mm ²
Flexible / Flexible with ferrule	mm ²
Tightening torque / Clamping screw	Nm
Tightening torque Separating screw	-
Stripping length / Blade size	mm/-

In accordance with IEC 60947-7-1

IEC	UL	CSA	EN 60079-7
400			
125			
35			
		6 kV / 3	
		B8 / V-0	

CE

Rated connection	
2.5...16 / 2.5...50	
2.5...35	
4...5 / (M 6)	
18 / 6.5 x 1.2 mm	

Tightening torque, N-isolator: 1.2...2.4 Nm

Note

Ordering data

Version	dark beige
	Blue
Note	

Type	Qty.	Order No.
WNT 35N 10X3	20	1718550000

Accessories

End plate / Partition plate	
	dark beige
	Blue
Support bracket for 10 x 3 (required every 20 cm)	
	Blue
End bracket	
	dark beige
Screwdriver	
	With "swifty set" cutting device
	Standard
Busbar 10 x 3 (140 A)	
Clamping yoke for power supply to 10 x 3 busbars	
	Rigid / flexible 0.5 - 6 / 4 mm ²
	Rigid / flexible 6 - 16 mm ²
	flexible 16 - 35 mm ²
Marking tags	

Type	Qty.	Order No.
WAP 2.5-10	50	1050000000
WAP 2.5-10 BL	50	1050080000
WHP 2.5-35N/10X3 BL	20	1050280000
WEW 35/2	50	1061200000
SWIFTY SET	1	9006060000
SDS 0.6X3.5X100	1	2749340000
SSCH 10X3X1000 CU/SN	140 A	0348900000
ZB 4	50	0316500000
ZB 16 ZKSC	50	0316600000
ZB 35/M6X16	20	0266500000
DEK 5/5 MC NE WS	1000	1609801044
WS 12/5 MC NE WS	720	1609860000

For detailed information on other accessories and application in the online catalogue

WNT 70N

70 mm²

Compact design

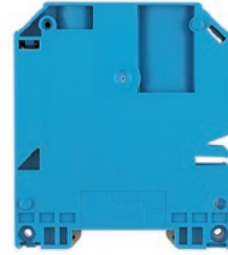

20.5 x 75 x 85	
140 / 95	NT
10...95	

In accordance with IEC 60947-7-1

IEC	UL	CSA	EN 60079-7
400	600		
140	175		
70	AWG 6...0		
		6 kV / 3	
		B11 / V-0	

CE

Rated connection	
10...16 / 10...95	
10...70	
6...12 / (M 8)	
22 / S6 (DIN 6911)	

Tightening torque, N-isolator 2.5...5.0 Nm

Type	Qty.	Order No.
WNT 70N/35	10	9512210000

Type	Qty.	Order No.
WAP 2.5-10	50	1050000000
WAP 2.5-10 BL	50	1050080000
WHP 2.5-35N/10X3 BL	20	1050280000
WEW 35/2	50	1061200000
SWIFTY SET	1	9006060000
SDS 0.6X3.5X100	1	2749340000
SSCH 10X3X1000 CU/SN	140 A	0348900000
ZB 4	50	0316500000
ZB 16 ZKSC	50	0316600000
ZB 35/M6X16	20	0266500000
DEK 5/5 MC NE WS	1000	1609801044
WS 12/5 MC NE WS	720	1609860000



Building installation wiring
Screw connection



WDL 2.5/NT/L/PE

2.5 mm²

WDL 2.5/L/L

2.5 mm²

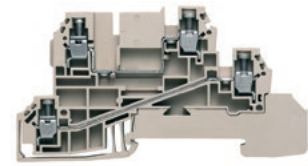
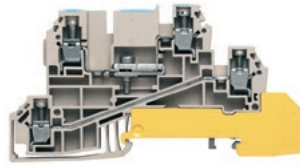

Width/Height/Depth	mm
Rated current / max. cond. cross-section	A/mm ²
Max. clamping range	mm ²

6.1 x 90 x 48	
24 / 4	
0.13...4	

6.1 x 90 x 48	
24 / 4	
0.13...4	

Technical data

Rated data	
Rated voltage	V
max. current	A
for wire cross-section	mm ²
Rated impulse withstand voltage / Pollution severity	
Gauge to IEC 60947-1 / UL 94 flammability rating	
Approvals	
Clamped conductors (H05V/H07V)	
Solid / Stranded	mm ²
Flexible / Flexible with ferrule	mm ²
Twin wire-end ferrule	-
Stripping length / Blade size	mm/-
Rated voltage	
Rated voltage (L / L)	V
Rated voltage (L / N)	V
Rated voltage (L / PE)	V
Note	

IEC 60947-7-1 (-7-2)

IEC	UL	CSA	EN 60079-7
400	300	300	
32	15	10	
2.5	AWG 26...12	AWG 26...12	
4 kV / 3			
A3, A4 / V-0			

CE CB CB N RA

Rated connection
0.5...4 / 1.5...4
0.5...4 / 0.5...4

8 / 0.6 x 3.5 mm

Rated voltage
400
250
250

IEC 60947-7-1

IEC	UL	CSA	EN 60079-7
400	300	300	
32	15	10	
2.5	AWG 26...12	AWG 26...12	
6 kV / 3			
A3, A4 / V-0			

CE CB CB N RA

Rated connection
0.5...4 / 1.5...4
0.5...4 / 0.5...4

8 / 0.6 x 3.5 mm

Rated voltage
400
250
250

Ordering data

Version	dark beige
Note	

Type	Qty.	Order No.
WDL 2.5/NT/L/PE	50	1029800000

Type	Qty.	Order No.
WDL 2.5/L/L	50	1030300000

Accessories

Screwable cross-connection	
2-pole	
3-pole	
4-pole	
10-pole	
20-/24-pole	
End plate / Partition plate	
dark beige	
Support bracket for 10 x 3 (required every 20 cm)	
dark beige	
End bracket	
dark beige	
Screwdriver	
With "swifty set" cutting device	
Standard	
Marking tags	

Type	Qty.	Order No.
Q 2 WDL2.5S	24 A 50	1071500000
Q 3 WDL2.5S	24 A 50	1071600000
Q 4 WDL2.5S	24 A 50	1071700000
Q 10 WDL2.5S	24 A 20	1071800000
Q 20 WDL2.5S	24 A 20	1074200000
WAP WDL2.5	20	1067800000
WHP WDL2.5/S BL	20	1067980000
WEW 35/2	50	1061200000
SWIFTY SET	1	9006060000
SDIS 0.6X3.5X100	1	2749810000
DEK 5/5 MC NE WS	1000	1609801044
WS 8/5 MC NE WS	720	1640740000

Type	Qty.	Order No.
Q 2 WDL2.5S	24 A 50	1071500000
Q 3 WDL2.5S	24 A 50	1071600000
Q 4 WDL2.5S	24 A 50	1071700000
Q 10 WDL2.5S	24 A 20	1071800000
Q 20 WDL2.5S	24 A 20	1074200000
WAP WDL2.5	20	1067800000
WHP WDL2.5/S BL	20	1067980000
WEW 35/2	50	1061200000
SWIFTY SET	1	9006060000
SDIS 0.6X3.5X100	1	2749810000
DEK 5/5 MC NE WS	1000	1609801044
WS 8/5 MC NE WS	720	1640740000

For detailed information on other accessories and application in the online catalogue

WDL 2.5/N/L/PE

2.5 mm²

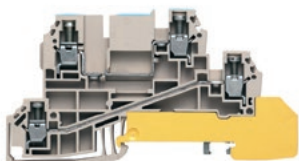

6.1 x 90 x 48
24 / 4
0.13...4

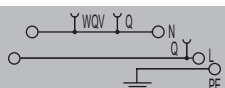

IEC 60947-7-1 (-7-2)

IEC	UL	CSA	EN 60079-7
400	300	300	
32	15	10	
2.5	AWG 26...12	AWG 26...12	
4 kV / 3			
A3, A4 / V-0			

CE ENE N

Rated connection

0.5...4 / 1.5...4

0.5...4 / 0.5...4

8 / 0.6 x 3.5 mm

400

250

250

Type	Qty.	Order No.
WDL 2.5/N/L/PE	50	1029900000

Type	Qty.	Order No.
Q 2 WDL2.5S	24 A 50	1071500000
Q 3 WDL2.5S	24 A 50	1071600000
Q 4 WDL2.5S	24 A 50	1071700000
Q 10 WDL2.5S	24 A 20	1071800000
Q 20 WDL2.5S	24 A 20	1074200000
WAP WDL2.5	20	1067800000
WHP WDL2.5/S BL	20	1067980000
WEW 35/2	50	1061200000
SWIFTY SET	1	9006060000
SDIS 0.6X3.5X100	1	2749810000
DEK 5/5 MC NE WS	1000	1609801044
WS 8/5 MC NE WS	720	1640740000

WDL 2.5/L/L/PE

2.5 mm²

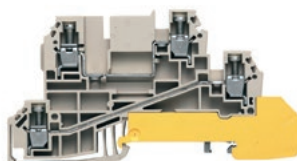

6.1 x 90 x 48
24 / 4
0.13...4

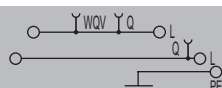

IEC 60947-7-1 (-7-2)

IEC	UL	CSA	EN 60079-7
400	300	300	
32	15	10	
2.5	AWG 26...12	AWG 26...12	
4 kV / 3			
A3, A4 / V-0			

CE ENE N

Rated connection

0.5...4 / 1.5...4

0.5...4 / 0.5...4

8 / 0.6 x 3.5 mm

400

250

250

Type	Qty.	Order No.
WDL 2.5/L/L/PE	50	1030200000

Type	Qty.	Order No.
Q 2 WDL2.5S	24 A 50	1071500000
Q 3 WDL2.5S	24 A 50	1071600000
Q 4 WDL2.5S	24 A 50	1071700000
Q 10 WDL2.5S	24 A 20	1071800000
Q 20 WDL2.5S	24 A 20	1074200000
WAP WDL2.5	20	1067800000
WHP WDL2.5/S BL	20	1067980000
WEW 35/2	50	1061200000
SWIFTY SET	1	9006060000
SDIS 0.6X3.5X100	1	2749810000
DEK 5/5 MC NE WS	1000	1609801044
WS 8/5 MC NE WS	720	1640740000



Building installation wiring
Screw connection



WDL 2.5/S/NT/L/PE

2.5 mm²

WDL 2.5/S/L/L

2.5 mm²

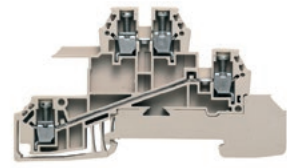
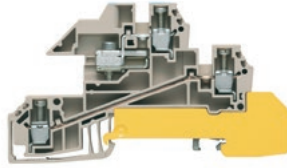

Width/Height/Depth	mm
Rated current / max. cond. cross-section	A/mm ²
Max. clamping range	mm ²

6.1 x 84.5 x 48	
24 / 4	
0.13...4	

6.1 x 84.5 x 48	
24 / 4	
0.13...4	

Technical data

Rated data	
Rated voltage	V
max. current	A
for wire cross-section	mm ²
Rated impulse withstand voltage / Pollution severity	
Gauge to IEC 60947-1 / UL 94 flammability rating	
Approvals	
Clamped conductors (H05V/H07V)	
Solid / Stranded	mm ²
Flexible / Flexible with ferrule	mm ²
Twin wire-end ferrule	-
Stripping length / Blade size	mm/-
Rated voltage	
Rated voltage (L / L)	V
Rated voltage (L / N)	V
Rated voltage (L / PE)	V
Note	

In accordance with IEC 60947-7-1

IEC	UL	CSA	EN 60079-7
400	300	300	
32	15	10	
2.5	AWG 26...12	AWG 26...12	
4 kV / 3			
A3 / V-0			

CE

Rated connection	
0.5...4 / 1.5...4	
0.5...4 / 0.25...2.5	

8 / 0.6 x 3.5 mm

Rated voltage	
Rated voltage (L / L)	V
Rated voltage (L / N)	V
Rated voltage (L / PE)	V

400
250
250

Rated voltage L-PE and L-NT 250 V.
Tightening torque for isolator 0.4.0.6 Nm

IEC 60947-7-1

IEC	UL	CSA	EN 60079-7
400	300	300	
32	15	10	
2.5	AWG 26...12	AWG 26...12	
6 kV / 3			
A3 / V-0			

CE

Rated connection	
0.5...4 / 1.5...4	
0.5...4 / 0.25...2.5	

8 / 0.6 x 3.5 mm

Rated voltage	
Rated voltage (L / L)	V
Rated voltage (L / N)	V
Rated voltage (L / PE)	V

400
250
250

Ordering data

Version	dark beige
Note	

Type	Qty.	Order No.
WDL 2.5/S/NT/L/PE	50	1030600000

Type	Qty.	Order No.
WDL 2.5/S/L/L	50	1031200000

Accessories

Screwable cross-connection	
2-pole	
3-pole	
4-pole	
10-pole	
20-/24-pole	
End bracket	
	dark beige
End plate / Partition plate	
	dark beige
Support bracket for 10 x 3 (required every 20 cm)	
	dark beige
Busbar 10 x 3 (140 A)	
Clamping yoke for power supply to 10 x 3 busbars	
Rigid / flexible 0.5 - 6 / 4 mm ²	
Rigid / flexible 6 - 16 mm ²	
flexible 16 - 35 mm ²	
Marking tags	

Type	Qty.	Order No.
Q 2 WDL2.5S	24 A 50	1071500000
Q 3 WDL2.5S	24 A 50	1071600000
Q 4 WDL2.5S	24 A 50	1071700000
Q 10 WDL2.5S	24 A 20	1071800000
Q 20 WDL2.5S	24 A 20	1074200000
WEW 35/2	50	1061200000
WAP WDL2.5/S	20	1067700000
WHP WDL2.5/S BL	20	1067980000
SSCH 10X3X1000 CU/SN	140 A 1	0348900000
ZB 4	50	0316500000
ZB 16 ZKSC	50	0316600000
ZB 35/M6X16	20	0266500000
DEK 5/5 MC NE WS	1000	1609801044
WS 8/5 MC NE WS	720	1640740000

Type	Qty.	Order No.
Q 2 WDL2.5S	24 A 50	1071500000
Q 3 WDL2.5S	24 A 50	1071600000
Q 4 WDL2.5S	24 A 50	1071700000
Q 10 WDL2.5S	24 A 20	1071800000
Q 20 WDL2.5S	24 A 20	1074200000
WEW 35/2	50	1061200000
WAP WDL2.5/S	20	1067700000
WHP WDL2.5/S BL	20	1067980000
SSCH 10X3X1000 CU/SN	140 A 1	0348900000
ZB 4	50	0316500000
ZB 16 ZKSC	50	0316600000
ZB 35/M6X16	20	0266500000
DEK 5/5 MC NE WS	1000	1609801044
WS 8/5 MC NE WS	720	1640740000

For detailed information on other accessories and application in the online catalogue

WDL 2.5/S/N/L/PE

2.5 mm²

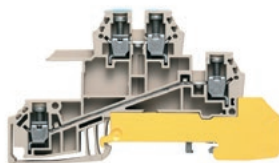

6.1 x 84.5 x 48
24 / 4
0.13...4

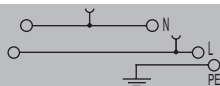

IEC 60947-7-1 (-7-2)

IEC	UL	CSA	EN 60079-7
400	300	300	
32	15	10	
2.5	AWG 26...12	AWG 26...12	
4 kV / 3			
A3 / V-0			

CE ENEC NEMA

Rated connection

0.5...4 / 1.5...4
0.5...4 / 0.25...2.5

8 / 0.6 x 3.5 mm

400

250

250

L-PE / L-N 250 V

Type	Qty.	Order No.
WDL 2.5/S/N/L/PE	50	1030700000

Type	Qty.	Order No.	
Q 2 WDL2.5S	24 A	50	1071500000
Q 3 WDL2.5S	24 A	50	1071600000
Q 4 WDL2.5S	24 A	50	1071700000
Q 10 WDL2.5S	24 A	20	1071800000
Q 20 WDL2.5S	24 A	20	1074200000
WEW 35/2	50	1061200000	
WAP WDL2.5/S	20	1067700000	
WHP WDL2.5/S BL	20	1067980000	
SSCH 10X3X1000 CU/SN	140 A	1	0348900000
ZB 4	50	0316500000	
ZB 16 ZKSC	50	0316600000	
ZB 35/M6X16	20	0266500000	
DEK 5/5 MC NE WS	1000	1609801044	
WS 8/5 MC NE WS	720	1640740000	

WDL 2.5/S/L/L/PE

2.5 mm²

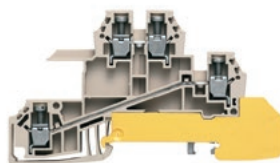

6.1 x 84.5 x 48
24 / 4
0.13...4

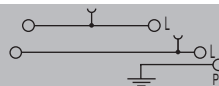

IEC 60947-7-1 (-7-2)

IEC	UL	CSA	EN 60079-7
400	300	300	
32	15	10	
2.5	AWG 26...12	AWG 26...12	
4 kV / 3			
A3 / V-0			

CE ENEC NEMA

Rated connection

0.5...4 / 1.5...4
0.5...4 / 0.25...2.5

8 / 0.6 x 3.5 mm

400

250

250

L-PE 250 V

Type	Qty.	Order No.
WDL 2.5/S/L/L/PE	50	1031100000

Type	Qty.	Order No.	
Q 2 WDL2.5S	24 A	50	1071500000
Q 3 WDL2.5S	24 A	50	1071600000
Q 4 WDL2.5S	24 A	50	1071700000
Q 10 WDL2.5S	24 A	20	1071800000
Q 20 WDL2.5S	24 A	20	1074200000
WEW 35/2	50	1061200000	
WAP WDL2.5/S	20	1067700000	
WHP WDL2.5/S BL	20	1067980000	
SSCH 10X3X1000 CU/SN	140 A	1	0348900000
ZB 4	50	0316500000	
ZB 16 ZKSC	50	0316600000	
ZB 35/M6X16	20	0266500000	
DEK 5/5 MC NE WS	1000	1609801044	
WS 8/5 MC NE WS	720	1640740000	





Installation

Installation	Assembly instructions	C.2
	Mounting accessories	C.10
	Busbars and accessories	C.24
	Marking system	C.34
	Tools	C.36
	Enclosure system	C.38
	Materials	C.40
	Standards and regulations	C.46

General technical notes

Useful tips from planning through to installation

As a system planner, you bear the responsibility for the correct selection of solutions and components. The IEC standard and the DIN EN 61439 “Low-voltage switchgear and controlgear assemblies” standard support you here. They stipulate the planning and construction requirements, as well as the necessary design verifications. The essential prerequisites are, of course, professional handling of equipment and observance of the rules in force. Only in this way can hazards to persons and property be avoided when they are dealing with electrical energy. In particular, installation, maintenance work, modifications and retrofitting may only be carried out by qualified personnel and in compliance with the general installation and safety regulations for work on power installations.

Our promise

Connections in the panel have to satisfy numerous rules and conditions. Whether installing terminal strips and terminal blocks or using aluminium conductors – we provide you with useful tips that make your work easier.

Operating conditions

The specifications contained in the documentation apply, insofar as no separate stipulations apply, for the recommended installation position and for environmental conditions in the case of indoor installation (pollution severity 3, in exceptional cases 2) in accordance with IEC 60439-1 and IEC 61439-1/2/3. The user has to refer the manufacturer to special operating conditions deviating from this standard! You have to provide for installation-specific reduction factors depending on the actual operating conditions. The load factors listed in the table below constitute guidelines.

What you have to observe for installation

In the case of products containing cartridge fuses, you have to follow the specifications from the associated product standards with regard to the wire cross-sections to be connected. The specified temperature resistance of the plastics used has to be observed.

Here, we recommend installing the products vertically on horizontal terminal rail systems. The rated load factors in the table are applicable for this installation position and also for components with permissible power losses. This also pertains to the environmental conditions in accordance with IEC 60439-1, section 6.1.1.1 and IEC 61439-2/3, section 7.1.1.1.

Guidelines for rated load factors

Number of main circuits	Rated load factor	
	acc. to IEC 61439-2	acc. to IEC 61439-3
2 and 3	0.9	0.8
4 and 5	0.8	0.7
6 to 9 inclusive	0.7	0.6
10 and more	0.6	0.5

IEC 61439
 Part 2: Power switchgear and controlgear assemblies
 Part 3: Distribution boards intended to be operated by ordinary persons

And what if the conditions deviate

In case of a deviation in the installation position and operating conditions, you have to consider all the factors influencing the maximum temperature. These include, for example:

- Power output of the cartridge fuses and the devices in operation
- Timings, full and partial load, concurrency
- Arrangement in the system, mutual interaction between the devices
- Rail cross-section, conductor cross-section
- Ambient temperature, flow conditions, ventilation and cooling through additional correction factors

Installation positions are inadmissible in which gravity works against the direction of contact movement. Clearance and creepage distances have to be measured in accordance with IEC 60664-1 (VDE 0110 Part 1). Above 12 mm, all IEC requirements are met up to 690 V AC. You also have to consider further factors, such as minimum distances to grounded parts. This particularly applies for UL applications. You also need to avoid the harmful influences of chemical substances during storage, processing and operation.

CE marking

Our products are subject to mandatory CE-marking in conjunction with Low Voltage Directive. We have affixed the CE mark on the individual packing units and partly on the products themselves. We hereby confirm to you that our products comply with the applicable regulations. We would be pleased to provide you with the relevant declarations of conformity at our company.

RoHS Directive

The restriction of lead and nine other potentially hazardous substances in electrical and electronic equipment is specified by the EU-Directive RoHS. As a value-oriented company, Weidmüller is aware of its responsibility towards customers, employees, society and the environment. It is therefore a matter of course for Weidmüller to assume its responsibility within the framework of the RoHS Directive 2011/65/EU.

www.weidmueller.com/rohs

Our tips for you

It always has to be ensured that ...

- all accessible parts are deactivated during installation and maintenance work
- connections are made with the prescribed torque, suitable fitted parts are used and parts are completely installed for touch-safe protection
- connections are checked and, if necessary, tightened after transportation
- the products are used and operated according to the intended purpose
- the technical description in the product manual and the installation instructions are observed and the documents are kept accessible for subsequent maintenance work, modifications and retrofitting
- modifications that serve for advancement and technical progress are reserved

REACH Regulation

The European Chemical Regulation REACH stands for registration, evaluation and authorization of chemicals. As an environmentally conscious company Weidmüller takes its responsibility for communication within the supply chain and for the entire information flow within the REACH regulation.

www.weidmueller.com/reach

Mounting of terminal strips

Always a secure connection

Terminal strips are used for quick installation of cables and conductors. They are the interface from the panel to the outside world. Below, you will find some useful tips, information and binding rules to support you in mounting terminal strips.

Combinations of different terminal blocks

In case of a contour change, you have to use end plates and partition plates (WAP/TW, ZAP/TW and IAP). If terminal blocks with different rated voltages are arranged next to one another, you need end plates or partition plates (WAP/TW, ZAP/TW). Good to know: when arranging the PE terminal block next to, or between the associated feed-through terminals blocks of the same series and size, the rated voltage and the rated impulse voltage of the feed-through terminal blocks are not influenced.

Dimensions

The dimension of the housing enclosing the terminal blocks and fastening components is specified, but without tolerances. Please consider a mounting tolerance of 0.2 mm to the specified terminal width in your project design.

Partition plate

You use a partition plate for visual separation of circuits or for electrical isolation from neighbouring cross-connectors.

Small partition

In the case of terminal blocks, up to a terminal width of max. 12 mm, you can retroactively insert small partitions between cross-connections or sockets.

End bracket at the beginning and end of the terminal strip



Partition plates improve the overview

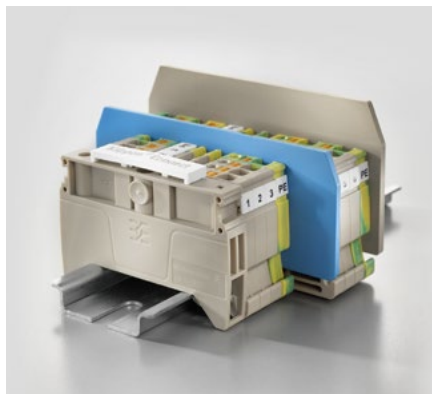

Troubleshooting with bipolar voltage tester incl. measurement probe according to IEC 61243-3



Compliance with the rated insulation voltage

We specify the required stripping length for all our products in mm. These lengths, e.g. $6 \text{ mm} \pm 0.5 \text{ mm}$, $\geq 10 \text{ mm} \pm 1 \text{ mm}$ are absolutely binding. This is also the case if you use wire-end ferrules. IEC 60947-1 applies for the outside dimension of crimped wire-end ferrules.

Working on electrical connectors with non-insulated screwdrivers

The following five rules apply for working on electrical systems and equipment with non-insulated screwdrivers:

- Disconnect the electrical systems
- Prevent from being switched back on
- Ascertain absence of voltage
- Earth and short-circuit
- Cover or block off neighbouring parts under voltage

Please find the individual measures to be taken in consideration of the operational and local conditions, for example high voltage and low voltage lines, cables or switchgear systems, in VDE 0105 Part 100.

Unused contact points under voltage

Protect unused contact points that may be live against inadvertent touching by using suitable covers, such as ADP 1 to 4. The clamping screws of unused contact points that are not live must also be tightened.

Tightening torque range for clamping screws

The test torque according to IEC 60947-1 or the torque according to the manufacturer's specifications is the lower value of the torque range. With this, all tests are passed. The upper value of the torque range is the maximum torque that may be applied.

Preferably set the electrical torque screwdriver to the midpoint torque of the terminal torque range. We have assigned product-specific data directly to the respective products.

Tightening the clamping screw in the specified torque ranges ensures:

- Reliable and gas-tight clamping
- No mechanical destruction of the clamping yokes
- Voltage drop well below the required limit value

Our installation tips for you

- The terminal strip structure is from left to right
- Place the closed side to the left, the open side to the right
- Always close the open side of the terminal strip with end plates or separation plates (WAP/TW, ZAP/TW)
- End brackets have to be placed at the beginning and end of a terminal strip

Connecting terminal blocks

With the right torque

The right torque is a decisive factor in professional connection of terminal blocks in order to avoid damage to the electrical systems. Therefore, always apply the tightening torque specified in the installation instructions or on the Internet for the product.

Unless limits are specified, the deviation of the tightening torque for screw and clamp connections may be a maximum of ± 20 percent of the rated value. If no range is specified for clamping cross-sections, the lower clamping range is

limited to two levels below the rated cross-section. Please find the relationships between the wire cross-sections in mm^2 and AWG/MCM sizes in the table below.

General technical data for conversion AWG* conductor to mm^2

AWG	mm^2
30	0.05
28	0.08
26	0.13
24	0.20
22	0.33
20	0.52
19	0.65
18	0.82
17	1.04
16	1.31
15	1.65
14	2.08
13	2.63
12	3.31
11	4.17
10	5.26
9	6.63
8	8.37
7	10.55
6	13.30
5	16.77
4	21.15
3	26.67
2	33.63
1	42.41
0	53.48
0 [1/0]	53.5
00 [2/0]	67.4
000 [3/0]	85
0000 [4/0]	107
250 kcmil	127
350 kcmil	177
500 kcmil	253
600 kcmil	304
800 kcmil	405
1000 kcmil	507

Plug gauge according to IEC 60947-1: insertability of unprepared round conductors with the largest defined cross-section

Cable diameter		Gauge						
		Shape A			Shape B			
Flexible conductors mm^2	Solid conductors (one or more wires) mm^2	Designation	Diameter a mm	Width b mm	Designation	Diameter a mm	Permissible deviation for a and b mm	
1.5	1.5	A 1	2.4	1.5	B 1	1.9	0 - 0.05	
2.5	2.5	A 2	2.8	2.0	B 2	2.4		
2.5	4	A 3	2.8	2.4	B 3	2.7		
4	6	A 4	3.6	3.1	B 4	3.5	0 - 0.06	
6	10	A 5	4.3	4.0	B 5	4.4		
10	16	A 6	5.4	5.1	B 6	5.3		
16	25	A 7	7.1	6.3	B 7	6.9	0 - 0.07	
25	35	A 8	8.3	7.8	B 8	8.2		
35	50	A 9	10.2	9.2	B 9	10.0		
50	70	A 10	12.3	11.0	B 10	12.0	0 - 0.08	
70	95	A 11	14.2	13.1	B 11	14.0		
95	120	A 12	16.2	15.1	B 12	16.0		
120	150	A 13	18.2	17.0	B 13	18.0		
150	185	A 14	20.2	19.0	B 14	20.0		
185	240	A 15	22.2	21.0	B 15	22.0	0 - 0.09	
240	300	A 16	26.5	24.0	B 16	26.0		

* AWG is the abbreviation for "American Wire Gauge".



Approval of wire-end ferrules

Wire-end ferrules are only ever approved for applications according to IEC/EN standards. We tested examples for the application of wire-end ferrules; this does represent any form of general approval for different ferrule pressings. You may have to reduce the maximum wire cross-sections. Conductors have to be manufactured taking into consideration the requirements of IEC/EN 60999-1 and -2 and have to be configured such that there is no tensile loading.

Two conductors at a contact point

You achieve assignment to individual circuits, identification and division of individual functional units optimally by only connecting one conductor to each contact point. Terminal blocks with screw connection (W-Series) are available to you should two conductors of the same cross-section be connected to a contact point. The connection of two cables with screwless contact points is forbidden according to DIN IEC 60999-1. Connection of two conductors is possible in terminal blocks with spring connection, however, by using twin wire-end ferrules.

Continuous current for two conductors

The total current of two conductors must not exceed the continuous current of the terminal block. The continuous current is the maximum current a terminal block can carry without exceeding a temperature increase of 45 K.

Rated voltage

The rated voltage of the terminal block does not change with the proper connection of two conductors.

Use of aluminium conductors

Very secure contact

Aluminium conductors have many advantages. However, various conditions must be met in order to achieve secure contact with these conductors. The specifications for the conductor connections for terminal blocks only apply for copper conductors. They do not apply to aluminium conductors.

Why is the use of aluminium conductors so attractive?

The use of aluminium conductors is becoming increasingly attractive, especially when conductors with cross-sections over 16 mm² are used. One advantage of aluminium as a wire material is its favourable price as compared with copper. Aluminium also weighs significantly less. This makes routing cables much easier.

Properties and physical influences of aluminium

The direct contact of aluminium as an electrical conductor is essentially determined by three physical influences:

- Exposure to oxygen immediately forms a non-conducting oxide layer on the surface of the aluminium conductor. The result is an increase in the contact resistance between the connection system and the aluminium conductor. In the worst case, this can lead to the terminal block catching fire.
- The conductivity of aluminium is one-third lower than that of copper. For this reason, the selection of the right cross-section should always be dependent on the maximum anticipated current. When using aluminium conductors, we therefore recommend always selecting one conductor size larger for the same current carrying capacity.
- Aluminium has a tendency to flow under mechanical pressure loading. This necessitates checking the specified torque prior to initial use and monitoring the torque applied after approx. 200 operating hours.

Professional processing and handling of aluminium conductors for direct connection

In order to ensure optimal connection of solid and sectional core aluminium conductors, the stripped end of the conductor must be cleaned of the oxide layer immediately by scraping, e.g. with a knife. Please note that no brushes, files or sandpaper may be used, as aluminium particles could be stuck and thus transferred to other conductors.

Immediately after removing the oxide layer, the end of the conductor has to be rubbed with neutral grease (for example with acid and alkali free vaseline) and connected in the terminal immediately. If the conductor has been disconnected and reconnected, the work steps have to be repeated.

Terminal blocks for aluminium conductors

WDU 2.5	20 A	solid 2,5 mm ²	0.4 NM
WDU 4	27 A	solid 4 mm ²	0.5 NM
WDU 6	35 A	solid 6 mm ²	0.8 NM
WDU 10	48 A	solid 10 mm ²	1.2 NM
WDU 16	50 A	solid "re" 16 mm ²	3.0 NM
WDU 35	60 A	solid 35 mm ²	4.0 NM
WDU 50N	118 A	solid and sector-shaped 50 mm ²	6.0 NM
WDU 70N	150 A	solid and sector-shaped 70 mm ²	12.0 NM
WDU 120	290 A	sector-shaped 150 mm ²	15.0 NM
WDU 240	415 A	solid and sector-shaped 240 mm ²	30.0 NM
WPD × 01 ...	152 A	25 mm ² solid, stranded and sector-shaped in acc. with IEC 61238-1	4 NM
WPD × 02 ...	202 A	35 mm ² solid, stranded and sector-shaped in acc. with IEC 61238-1	16 ² = 4.0 NM 25 ² = 6.0 NM 35 ² = 8.0 NM
WPD × 03 ...	300 A	70 mm ² solid, stranded and sector-shaped in acc. with IEC 61238-1	16 ² = 4.0 NM 25 ² = 6.0 NM 35 ² = 8.0 NM 50 ² = 10.0 NM 70 ² = 18.0 NM

* Further terminal blocks, with data for the aluminium connection, could be found in the chapters power supply, power distribution and building installation wiring. (WPD series)



In case of WDU 240, the manufacturer’s specifications concerning current-carrying capacity of the aluminium conductor used have to be observed. This is usually well below 400 A.

Professional preparation and handling of aluminium conductors with indirect connection

Indirect connection of aluminium conductors is the safest choice. This can be enabled through the use of connecting elements, such as Al/Cu ring cable lugs or compression bolts. Nevertheless, the relevant manufacturer’s specifications must also be observed here and the contact point checked according to the operating instructions.

For normal environmental conditions and load cases, we recommend checking at intervals of six months. With unfavourable operating conditions or frequent temperature changes at the contact points, a shorter interval may be necessary. Temperature measurement strips with storage of maximum values can be attached in the immediate vicinity of the contact points and may be useful for objective assessment with regular tests. All contact points are suitable for the connection of one conductor, unless noted otherwise.



Installation instructions for flat cable lugs

When tightening the terminals, it is recommended to apply a counter-force on the conductor to avoid deformation of the terminal rail and to keep the foot of the terminal free of torsion forces. Connection of stranded aluminium conductors to terminal blocks is achieved with the aid of an aluminium cable lug. This is selected according to the shape of the conductor and is connected to the cable lug manufacturer’s specifications. Cu/Al washers are required at the junction of aluminium cable lugs to the terminal block current bar. Only then is a smooth transition from copper to aluminium ensured. They are fitted such that the copper side of the current bar and the aluminium side make contact with the aluminium cable lug.

Mounting screw

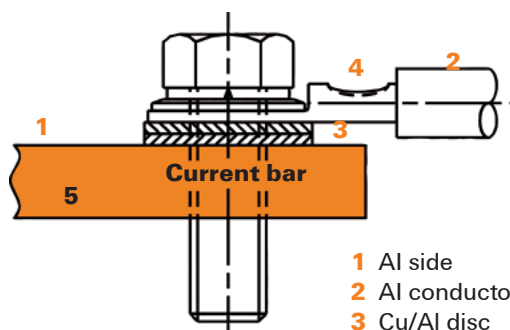

- 1 Al side
- 2 Al conductor
- 3 Cu/Al disc
- 4 Al cable lug
- 5 Cu side

Installation in conformity with standards

With precisely matched accessories

When mounting terminal blocks and assembling panels, you must always be able to rely on accessories fitting perfectly. Only then do the processes run smoothly and therefore productively. The requirements placed on terminal rails, busbars, as well as cover plates and support brackets, are correspondingly high. They have to comply with numerous standards and safety regulations.

Our promise

Our components are aligned to each other right down to the finest detail and hence make installation easier for you.

Information and ordering data for mounting accessories is available to you in our online catalogue.

Terminal rails

Terminal and top-hat rails for component mounting and end brackets are important for holding and insulating the components. Depending on the application area, we offer terminal rails made of steel, stainless steel, aluminium, copper or plastic.

Stainless steel

Stainless steel is a collective term for all types of steel (alloys) with a high degree of purity and corrosion resistance.

Aluminium

Aluminium has the second best electrical conductivity after copper. One advantage is low weight, another is outstanding corrosion protection.

Copper

Copper has the best electrical conductivity of all metals used. The copper rail has the highest short-circuit protection.

Plastic

Plastic terminal rails have insulating properties and are very light. They can be used where clearance and creepage distances to the support bracket cannot be achieved with standard terminal rails.

Steel

Steel terminal rails are the most widespread on the market. Among metal terminal rails, they have the lowest short-circuit protection, similar to stainless steel.

Use as PE conductors or PEN busbars

Under certain circumstances, you can also use terminal rails as bus bars for protective conductors (PE conductors) or PEN conductors. The Weidmüller PE terminal blocks with spring and screw connections fulfil the requirements for PE conductors defined in IEC 60947-7-2. According to VDE 0100 Part 540, protective earth conductors and neutral conductors with wire cross-sections above 10 mm² may be combined to form a conductor abbreviated as PEN.

Our installation tip

If a terminal rail is used as a PEN busbar, the following criteria have to be observed:

- Only profiles made of E-Cu or aluminium are permissible
- Short-circuit currents and thermal rated currents
- Insulate terminal rails with the "protective insulation" protective measure



Busbars

In the case of switchgear and control systems it, may be necessary to bring the neutral and PE conductor together on busbars. They offer the possibility of connecting a large number of conductors (on 1 m rails up to 70 conductors) with a low space requirement – either via a pressure piece or a clamping yoke. The SH rail support (which can also be arranged between the clamping yokes for longer bar) serves for fixing purposes. If the clamping yoke is used as protective earth connection, we can optionally supply it with green-yellow or as neutral conductor with blue insulation cap.

Cover profiles and support brackets

Several safety regulations, such as the accident prevention regulation “Electrical Installations and Equipment” (VBG 4) and VDE 0140-1 „Protection against electric shock”, require from you that active parts of electrical equipment are protected against direct touching. Our cover profiles with associated support brackets may be used for the most common terminal sizes. The support brackets can be arranged at the end or along the the terminal strip. They can be fastened to TS 32, TS 35 or TS 15 terminal rails.

Our installation tip

- In order to combine neutral or protective earth conductors at a central point, the ZB clamping yoke can be used together advantageously with the 10 × 3 or 6 × 6 busbars
- The ZBE 6 can be retroactively swivelled on to the busbars

Our installation tip

- Linear intervals of the support brackets: the linear measure of the ADP 1, 2 and 3 between the support brackets should not significantly exceed 300 mm
- The cover profile is also snapped on to tags at the sides; extra tightness is achieved with pegs on the support brackets for sealing purposes
- The transparent design of the profiles allows terminals with accessories and marking to be identified at any time. Additional markings, e.g. from groups, can also be applied

Mounting accessories – Busbars

Busbars, unslotted



SSch

Type	Material	Dimensions	Rated current	Qty.	Order No.
SSCH 6X6X1000 CU/SN	Copper	6 / 6 / 1000 mm	140 A	1 M	0571300000
SSCH 7.3X1.2X1000	Copper	7.3 / 1.2 / 1000 mm		1 M	1071200000
SSCH 10X3X1000 CU/SN	Copper	10 / 3 / 1000 mm	140 A	1 M	0348900000
SSCH 10X3X1000 ST/ZN	Steel	10 / 3 / 1000 mm		1 M	0438000000
SSCH 10X3X2000 CU VERZ.	Copper	10 / 3 / 2000 mm		2 M	1397000000
SSCH 15X6X1000 CU/SN	Copper	15 / 6 / 1000 mm	265 A	1 M	0357400000

Busbars, slotted

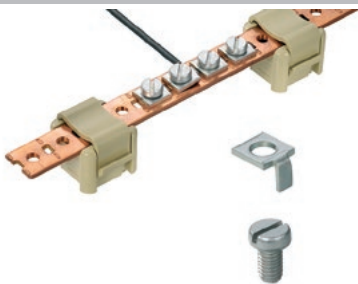

NSch / ESch

Type	Material	Dimensions	Rated current	Qty.	Order No.
ESCH 1 M	Steel	1000 / 2 / 12 mm	24 A	10 M	0280300000
NSCH 1M	Copper	1000 / 2 / 15 mm	24 A	10 M	0280200000
NSCH 2M	Copper	2000 / 2 / 15 mm	24 A	2 M	1313600000
Pressure piece				Qty.	Order No.
DKSUE NSCH/ESCH				100	0280100000
Clamping screw					
BFSC M5X8 SCHLITZ				100	0296700000

For solid conductors and cable lugs according to DIN 46234.

Rail support

With yoke and base

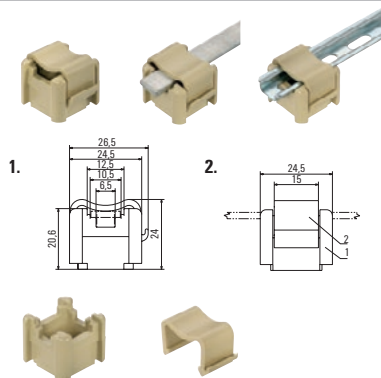

SH 1

Type	Material	Dimensions	Qty.	Order No.	
SH 1	Polyamide 66	26 / 24 / 24.5 mm	20 ST	0299860000	
Individual parts				Qty.	Order No.
SD SH1				20	0401460000
KLBUE SH1				20	0635960000
Mounting screw					
BFSC M4X9T				100	0103300000
BFSC M4X30				50	0267100000

SH 1: for busbar cross-section 10 x 3, 6 x 6, 15 x 2, 12 x 2, 15 x 2, 15 x 6

Rail support

With metal bridge

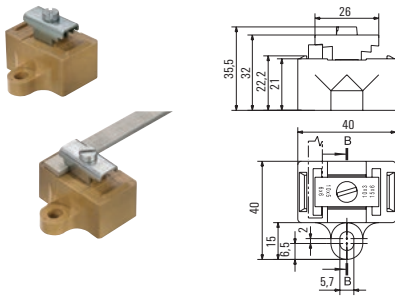

SH 2S

Type	Material	Dimensions	Qty.	Order No.
SH 2 S	KrG	40 / 35.5 / 40 mm	10 ST	0641720000
For busbar cross-section 10 x 3, 6 x 6, 10 x 5, 15 x 6				

Rail support

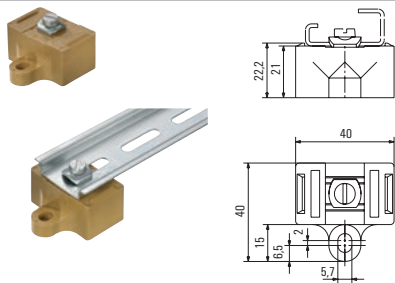

SH 2

Type	Material	Dimensions	Qty.	Order No.
SH 2	KrG	40 / 25 / 40 mm	10 ST	0494920000
The arrangement of mounting rails in totally insulated facilities				

Rail support

With metal bridge

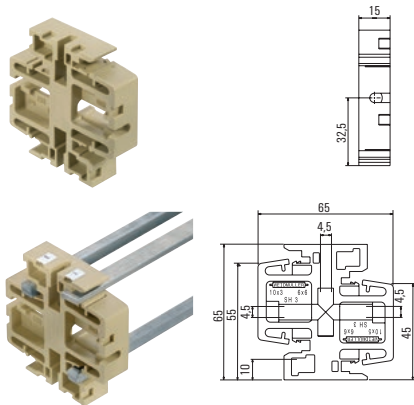

SH 3

Type	Material	Dimensions	Qty.	Order No.
SH 3	Polyamide 66	65 / 65 / 15 mm	10 ST	0556660000
For busbar cross-section 10 x 3, 6 x 6, 10 x 5				

Rail support



WEW

Type	Material	Dimensions	Qty.	Order No.
Polyamide with fibre glass, screwable				
WEW 35/1	Wemid	12 / 62.5 / 56 mm	50 ST	1059000000
WEW 35/2	Wemid	8 / 46.5 / 56 mm	50 ST	1061200000
WEW 35/1 GR	Wemid	12 / 62.5 / 56 mm	50 ST	1227890000
WEW 35/1 SW	Wemid	12 / 63 / 56 mm	50 ST	1162600000
WEW 35/2 GR	Wemid	8 / 46.5 / 56 mm	100 ST	1859200000
WEW 35/2 SW	Wemid	8 / 47 / 56 mm	50 ST	1061210000
For busbar cross-section 10 x 3, 6 x 6				

Busbar tap terminal



WBBD 16

Type	Rated voltage	Rated current	Clamping range min. / max.	Colour	Qty.	Order No.
WBBD 16 BL	690 V	114 A	1.5...16 mm ²	blue	12 ST	2603850000
WBBD 16 GN	690 V	114 A	1.5...16 mm ²	green	12 ST	2603860000
WBBD 16 GY	690 V	114 A	1.5...16 mm ²	grey	12 ST	2603840000

For busbar thickness 3...10 mm

Clamping yoke, uninsulated

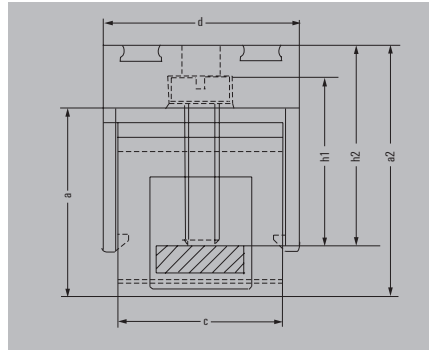

Tightening torques for clamping screws according to IEC 60947-1

Products with screw with slotted head		
Thread	Tightening torque	
	Steel screws	A 2/A 4-80
	min. 8.8	[Nm]
M 2	0.2...0.35	0.2...0.35
M 2.5	0.4...0.8	0.4...0.8
M 3	0.5...1.0	0.5...1.0
M 3.5	0.8...1.6	0.8...1.6
M 4	1.2...2.4	...
M 5	2.0...4.0	...
M 6	2.5...5.0	...

for busbar 10 x 3 mm



Solid	0.5...6 mm ²
Flexible	0.5...4 mm ²
Stranded	...
Clamping screw	M 3
Stripping length	16 mm

for busbar 10 x 3 mm

For subsequently slewing-in



Solid	1...10 mm ²
Flexible	1.5...10 mm ²
Stranded	...
Clamping screw	M 4
Stripping length	19 mm

for busbar 10 x 3 mm

Also for 10 x 5 mm busbars



Solid	1.5...10 mm ²
Flexible	2.5...10 mm ²
Stranded	...
Clamping screw	M 4
Stripping length	19 mm

for busbar 10 x 3 mm



Solid	2.5...16 mm ²
Flexible	2.5...16 mm ²
Stranded	16...25 mm ²
Clamping screw	M 4
Stripping length	16 mm

for busbar 10 x 3 mm



Solid	16...16 mm ²
Flexible	16...35 mm ²
Stranded	...
Clamping screw	M 6
Stripping length	19 mm

for busbar 6 x 6 mm



Solid	0.5...6 mm ²
Flexible	0.5...4 mm ²
Stranded	...
Clamping screw	M 3
Stripping length	16 mm

for busbar 6 x 6 mm



Solid	2.5...16 mm ²
Flexible	2.5...16 mm ²
Stranded	16...25 mm ²
Clamping screw	M 4
Stripping length	12 mm

ZB 4

Type	Colour	Width	Height	Depth	Qty.	Order No.
ZB 4	silver	5.3 mm	15.5 mm	16 mm	50	0316500000
IK 4 BL ZB4	silver	6 mm	19 mm	14.5 mm	50	0475480000
IK 4 GG ZB4	silver	6 mm	19 mm	14.5 mm	50	0475460000

ZBE 6

Type	Colour	Width	Height	Depth	Qty.	Order No.
ZBE 6	silver	8 mm	19 mm	28 mm	50	0459500000
IK 6 GG ZBE6K	silver	7.8 mm	22.5 mm	23 mm	50	0526060000

ZB 10

Type	Colour	Width	Height	Depth	Qty.	Order No.
ZB 10 F.10X3/10X5/10X10	silver	8 mm	19.5 mm	29.1 mm	50	1261300000

ZB 16

Type	Colour	Width	Height	Depth	Qty.	Order No.
ZB 16 ZKSC	silver	10 mm	16 mm	24 mm	50	0316600000
IK 16/ZB16 BL	silver	9 mm	19 mm	20 mm	50	0502980000
IK 16/ZB16 GG	silver	9 mm	19 mm	20 mm	50	0502960000

ZB 35

Type	Colour	Width	Height	Depth	Qty.	Order No.
ZB 35/M6X16	silver	14 mm	18 mm	34 mm	20	0266500000
IK 35/ZB35 BL	silver	14 mm	32 mm	8.6 mm	50	0502780000

ZB 4/6

Type	Colour	Width	Height	Depth	Qty.	Order No.
ZB 4/6	silver	5.3 mm	12 mm	20 mm	50	0556700000

ZB 16/6

Type	Colour	Width	Height	Depth	Qty.	Order No.
ZB 16/6	silver	10 mm	12.5 mm	30.7 mm	50	0556800000

Mounting accessories – Busbars

Clamping yoke, insulated

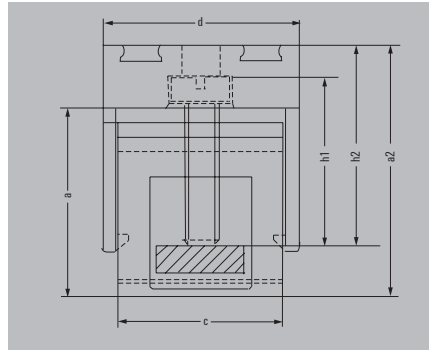

for busbar 10 x 3 mm



Solid	0.5...6 mm ²
Flexible	...
Stranded	...
Clamping screw	M 3
Stripping length	16 mm

for busbar 10 x 3 mm

For subsequently slewing-in



Solid	1...10 mm ²
Flexible	1.5...10 mm ²
Stranded	...
Clamping screw	M 4
Stripping length	19 mm

for busbar 10 x 3 mm



Solid	2.5...16 mm ²
Flexible	2.5...16 mm ²
Stranded	16...25 mm ²
Clamping screw	M 4
Stripping length	16 mm

for busbar 10 x 3 mm



Solid	16...16 mm ²
Flexible	16...35 mm ²
Stranded	...
Clamping screw	M 6
Stripping length	19 mm

for busbar 10 x 3 mm

Tension clamp connection



Solid	0.5...4 mm ²
Flexible	0.5...2.5 mm ²
Stranded	...
Clamping screw	...
Stripping length	10 mm

for busbar 6 x 6 mm



Solid	0.5...6 mm ²
Flexible	0.5...4 mm ²
Stranded	...
Clamping screw	M 3
Stripping length	16 mm

for busbar 6 x 6 mm



Solid	2.5...16 mm ²
Flexible	2.5...16 mm ²
Stranded	16...25 mm ²
Clamping screw	M 4
Stripping length	12 mm

ZB 4

Type	Colour	Width	Height	Depth	Qty.	Order No.
ZB 4G BL	silver	7.4 mm	19.5 mm	27 mm	50	0322180000
ZB 4G GN/GE	silver	7.4 mm	19.5 mm	27 mm	50	0322160000
ZB 4G SW	silver	7.4 mm	19.5 mm	27 mm	50	0322110000
ZB 4K BL	silver	6 mm	19 mm	20.4 mm	50	0475380000
ZB 4K GE/GN	silver	6 mm	19 mm	20.4 mm	50	0475360000

ZBE 6

Type	Colour	Width	Height	Depth	Qty.	Order No.
ZBE 6K BL	blue	8 mm	22.5 mm	19.5 mm	50	0525980000
ZBE 6K GE/GN	yellow, green	8 mm	22.5 mm	19.5 mm	50	0525960000
ZBE 6K SW	black	8 mm	22.5 mm	19.5 mm	50	0525910000

ZB 16K

Type	Colour	Width	Height	Depth	Qty.	Order No.
ZB 16K BL	silver	10 mm	19 mm	26.8 mm	50	0502880000
ZB 16K GE/GN	silver	10 mm	19 mm	26.8 mm	50	0502860000

ZB 35K

Type	Colour	Width	Height	Depth	Qty.	Order No.
ZB 35K BL M6X16	silver	14 mm	32 mm	34 mm	20	0502680000
ZB 35K GE/GN M6X16	silver	14 mm	32 mm	34 mm	20	0502660000
ZB 35K SW M6X16	silver	14 mm	32 mm	34 mm	20	0502610000

ZF 4 S

Type	Colour	Width	Height	Depth	Qty.	Order No.
ZF 4 S	silver	6.1 mm	24.5 mm	22 mm	50	1814680000
ZF 4 S BL	silver	6.1 mm	24.5 mm	22 mm	50	1814660000
ZF 4 S GN	green	6.1 mm	24.5 mm	22 mm	50	1814670000

ZB 4 / 6K

Type	Colour	Width	Height	Depth	Qty.	Order No.
ZB 4/6K BL	silver	6 mm	25 mm	14.7 mm	50	0565480000
ZB 4/6K GE/GN	silver	6 mm	25 mm	14.7 mm	50	0565460000

ZB 16 / 6K

Type	Colour	Width	Height	Depth	Qty.	Order No.
ZB 16/6K GE/GN	silver	10 mm	25 mm	30.7 mm	50	0569660000

TS 15 terminal rail

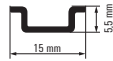

unslotted



TS 15 x 5

Type	Short circuit strength	Short-time withstand current	PEN function	Length	Thickness	Qty.	Order No.
Steel, galvanised and passivated							
TS 15X5 2M/ST/ZN	10.00 mm ²	1.2 kA/1s		2000mm	1.00 mm	2 M	0514200000

TS 15 terminal rail

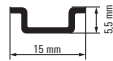

with slot

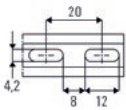

TS 15 x 5

Type	Short circuit strength	Short-time withstand current	PEN function	Length	Thickness	Qty.	Order No.
Steel, galvanised and passivated							
TS 15X5/LL 2M/ST/ZN	10.00 mm ²	1.2 kA/1s		2000mm	1.00 mm	2 M	0117500000
TS 15X5/LL 1M/ST/ZN	10.00 mm ²	1.2 kA/1s		1000mm	1.00 mm	1 M	0117510000

TS 20 terminal rail

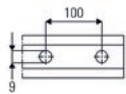

TS 20 x 10

Type	Short circuit strength	Short-time withstand current	PEN function	Length	Thickness	Qty.	Order No.
TS 20/CX10 2M/ST/ZN				2000mm	1.50 mm	2 M	0316400000

TS 27 terminal rail



TS 27 x 12.5

Type	Short circuit strength	Short-time withstand current	PEN function	Length	Thickness	Qty.	Order No.
TS 27X12.5M/ST/F.ZN				2000mm	2.00 mm	2 M	1802690000

Mounting accessories – DIN rails

TS 32 terminal rail

unslotted

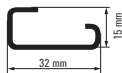

TS 32 terminal rail

with slot

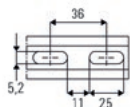

TS 35 x 7.5 terminal rail

unslotted



TS 35 x 7.5 terminal rail

with slot

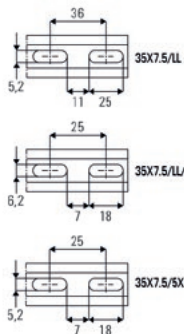

TS 32 x 15

Type	Short circuit strength	Short-time withstand current	PEN function	Length	Thickness	Qty.	Order No.
Aluminium							
TS 32X15 2M/AL/BK	70.00 mm ²	8.4 kA/1s	192.00 A	2000mm	1.50 mm	2 M	0169300000
Steel, galvanised and passivated							
TS 32X15 2M/ST/ZN	35.00 mm ²	4.2 kA/1s		2000mm	1.50 mm	2 M	0122800000
Stainless steel, rust-proof							
TS 32X15 2M/CRN				2000mm	1.50 mm	2 M	0293220000

TS 32 x 15

Type	Short circuit strength	Short-time withstand current	PEN function	Length	Thickness	Qty.	Order No.
Steel, galvanised and passivated							
TS 32X15/LL 2M/ST/ZN	35.00 mm ²	4.2 kA/1s		2000mm	1.50 mm	2 M	0514400000

TS 35 x 7.5

Type	Short circuit strength	Short-time withstand current	PEN function	Length	Thickness	Qty.	Order No.
Copper							
TS 35X7.5/1.0 2M/CU/BK	50.00 mm ²	6 kA/1s	150.00 A		1.00 mm	2 M	2731380000
Aluminium							
TS 35X7.5 2M/AL/BK	35.00 mm ²	4.2 kA/1s	125.00 A	2000mm	1.00 mm	2 M	0330800000
Steel, galvanised and passivated							
TS 35X7.5 2M/ST/ZN	16.00 mm ²	1.92 kA/1s		2000mm	1.00 mm	2 M	0383400000
TS 35X7.5 1M/ST/ZN	16.00 mm ²	1.92 kA/1s		1000mm	1.00 mm	1 M	0383410000
Stainless steel, rust-proof							
TS 35X7.5 2M/CRN				2000mm	1.00 mm	2 M	1747350000
TS 35X7.5 2M/CRN 316L					1.00 mm	2 M	2716000000

TS 35 x 7.5

Type	Short circuit strength	Short-time withstand current	PEN function	Length	Thickness	Qty.	Order No.
Steel, galvanised and passivated							
TS 35X7.5/LL 1M/ST/ZN	16.00 mm ²	1.92 kA/1s		1000mm	1.00 mm	1 M	0514510000
TS 35X7.5/LL 2M/ST/ZN	16.00 mm ²	1.92 kA/1s		2000mm	1.00 mm	2 M	0514500000
TS 35X7.5/LL 2M/ST/SZ	16.00 mm ²	1.92 kA/1s		2000mm	1.00 mm	2 M	7915060000
TS 35X7.5/LL/6 2M/ST/ZN	16.00 mm ²	1.92 kA/1s		2000mm	1.00 mm	2 M	0514570000
TS 35X7.5/LL/6X18 2M/O	16.00 mm ²	1.92 kA/1s		2000mm		2 M	1071690000
TS 35X7.5/5X18 2M/ST/SZ	16.00 mm ²	1.92 kA/1s		2000mm	1.00 mm	2 M	1879090000

TS 35 x 15 terminal rail



unslotted

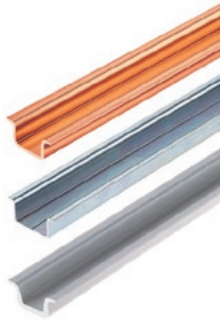

TS 35 x 15

Type	Short circuit strength	Short-time withstand current	PEN function	Length	Thickness	Qty.	Order No.
Copper							
TS 35X15/2.3 2M/CU/BK	150.00 mm ²	18 kA/1s	309.00 A	2000mm	2.30 mm	2 M	0270100000
Aluminium							
TS 35X15/2.3 2M/AL/BK	95.00 mm ²	11.4 kA/1s	232.00 A	2000mm	2.30 mm	2 M	1848290000
Steel, galvanised and passivated							
TS 35X15/2.3 2M/ST/ZN	50.00 mm ²	6 kA/1s		2000mm	2.30 mm	2 M	0498000000
TS 35X15 2M/ST/ZN	50.00 mm ²	6 kA/1s		2000mm	1.50 mm	2 M	0236400000
Plastic PVC RAL 7035							
TSK 35X15 2M PVC/GR				2000mm	3.00 mm	2 M	0514300000

TS 35 x 15 terminal rail



with slot

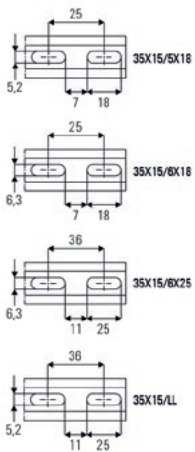

TS 35 x 15

Type	Short circuit strength	Short-time withstand current	PEN function	Length	Thickness	Qty.	Order No.
Steel, galvanised and passivated							
TS 35X15/5X18 2M/ST/SZ	50.00 mm ²	6 kA/1s		2000mm		2 M	1879100000
TS 35X15/5X18 2M/ST/ZN	50.00 mm ²	6 kA/1s		2000mm		2 M	1837380000
TS 35X15/6X18 2M/ST/ZN	50.00 mm ²	6 kA/1s		2000mm	1.50 mm	2 M	1805980000
TS 35X15/6X25 2M/ST/ZN	50.00 mm ²	6 kA/1s		2000mm		2 M	1866290000
TS 35X15/LL 1M/ST/ZN	50.00 mm ²	6 kA/1s		1000mm	1.50 mm	1 M	0236510000
TS 35X15/LL 2M/ST/SZ	50.00 mm ²	6 kA/1s		2000mm	1.50 mm	2 M	7907490000
TS 35X15/LL 2M/ST/ZN	50.00 mm ²	6 kA/1s		2000mm	1.50 mm	2 M	0236500000
TS 35X15/LL 2M/ST/ZN/D	50.00 mm ²	6 kA/1s		2000mm		2 M	1071680000

End cap for TS 35



End cap for TS 35

Type	PEN function	Height	Length	Qty.	Order No.
End cap TS 35 x 7,5					
TS END CAP 35X7,5		37.5 mm		100 ST	1283470000
End cap TS 35 x 15					
TS END CAP 35X15		37.5 mm		100 ST	1283480000

Mounting accessories – DIN rails

Mounting rail cutter



Terminal rail cutting and punching tool

Type	Width	Depth	Height	Qty.	Order No.
TSLD 5	270 mm	200 mm	205 mm	1 ST	9918700000
TSLD C	270 mm	200 mm	205 mm	1 ST	1270310000

for TS 15 terminal rail

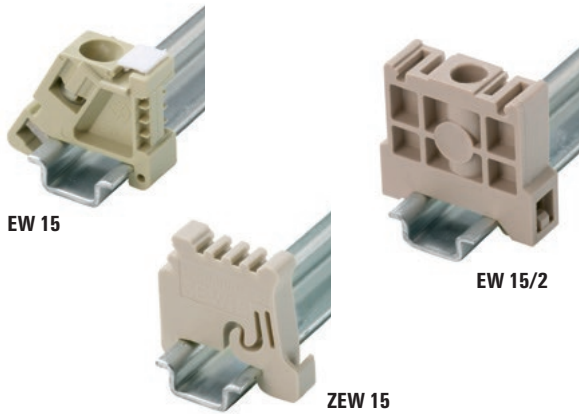

Type	Colour	Torque	Qty.	Order No.
Polyamide 66, screwable				
EW 15	beige	0.5 Nm	50	0382860000
Polyamide with fibre glass, screwable				
EW 15/2	dark beige	0.5 Nm	50	1071900000
Polyamide 66, screwless				
ZEW 15	beige		20	7920340000

for TS 32 terminal rail

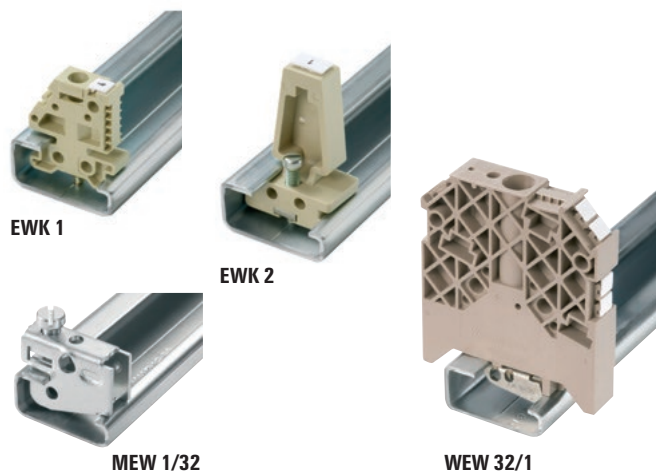

Type	Colour	Torque	Qty.	Order No.
Polyamide 66, screwable				
EWK 2	beige	0.5 Nm	50	0199360000
EWK 1	beige	0.5 Nm	50	0206160000
Polyamide with fibre glass, screwable				
WEW 32/1	dark beige		50	1067600000
Metal, screwable				
MEW 1/32	grey		20	0445600000

for TS 35 terminal rail

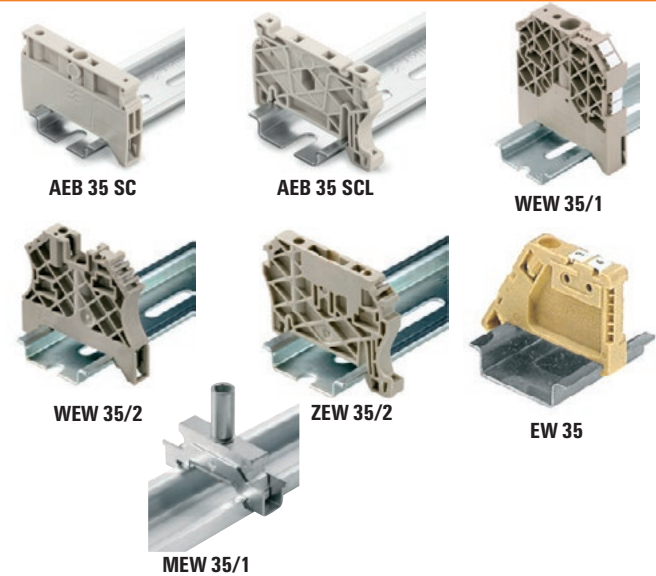

Type	Colour	Torque	Qty.	Order No.
Polyamide with fibre glass, screwable				
AEB 35 SC/1	dark beige	0.5 Nm	50	1991920000
AEB 35 SC/1 BK	black	0.5 Nm	50	2475310000
WEW 35/1	dark beige	1.2 Nm	50	1059000000
WEW 35/2	dark beige	0.5 Nm	50	1061200000
WEW 35/1 GR	grey	1.2 Nm	50	1227890000
WEW 35/1 SW	black	1.2 Nm	50	1162600000
WEW 35/2 GR	grey	0.5 Nm	100	1859200000
WEW 35/2 SW	black	0.5 Nm	50	1061210000
Polyamide 66, screwless				
AEB 35 SCL/1 V0	dark beige		20	2661280000
AEB 35 SCL/1 V0 BK	black		20	2661300000
AEB 35 SCL/1 V0 GY	Light Grey		20	2661290000
ZEW 35	dark beige		20	9540000000
ZEW 35/2	dark beige		20	8630740000
ZEW 35 GR	grey		20	1238040000
ZEW 35/2 GR	grey		20	1227850000
ZEW 35/2 SW	black		20	1162610000
Polyamide 66, screwable				
EW 35	beige	0.5 Nm	50	0383560000
EW 35 GR 7032	grey	0.5 Nm	50	0383530000
EW 35 DB	dark beige	0.5 Nm	50	1269050000
Metal, screwable				
MEW 35/1	grey		10	1805610000

Mounting accessories – DIN rail support / mounting feet

Terminal rail support



TSTW 5/M5
TSTW 5/M5 verzinkt
TSTW 6/M6

Type	Internal thread	Qty.	Order No.
TSTW 5/M5	M 5	10	0178100000
TSTW 5/M5 ZN	M 5	10	1779100000
TSTW 6/M6	M 6	10	0164000000
TSTW D 4.3		10	1610110000

Terminal rail supports of type TSTW serve for angled mounting of terminal rails at an angle of 35°.

Terminal rail support



TST

Type	Internal thread	Qty.	Order No.
TST 2/M5	M 5	10	1286600000
TST 2/M6	M 6	10	0101700000
Type		Qty.	Order No.
Mounting plates and fastening screws			
FKSC M6X8 D9/SW3		50	0642600000
Mounting screw			
FKSC M5X8 D9/SW2.5		50	0295900000
FKSC M6X12 D9/SW3		50	0353500000

The TST terminal rail support serves to install terminal rails in the frame or using a cut-out. For the terminal rail supports, Weidmüller offers fastening screws with hexagonal socket and an especially low head, such that terminal blocks can also be mounted above the screw.

Mounting feet



FM 4

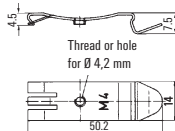

Type	Internal thread	Qty.	Order No.
FM 4 foot			
FM 4/TS35		40	0687900000
FM 5/TS35		40	0636800000
FM 6/TS35		40	0636900000
FM 4.2/TS35		40	1724580000
FM 4.2/TS35 without thread	FM 4.2/TS35 without thread		

Mounting feet



MOFU 35/LO/1

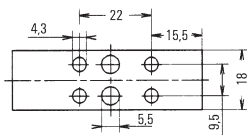

MOFU 35

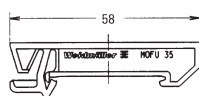

Type	Internal thread	Qty.	Order No.
MOFU 35/LO/1		20	0646260000
MOFU 35		20	0495660000
MOFU 35/LO/1 SW		20	0646210000

Mounting feet

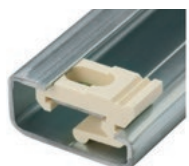

MB

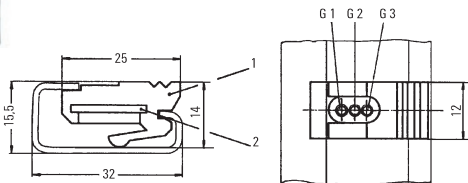

Type	Internal thread	Qty.	Order No.
MB M3/M5 CRM		20	0503500000
MB M5/M3 SW		20	0553400000
MB M6/M4 GR		20	0334900000





The sliding nuts for the TS 32 terminal rails are each fitted with two threaded holes for M3 + M5/M6 + M4/M5 + M3 screws. They serve to attach components that cannot be directly snapped onto the TS 32 and particularly to hold the smaller TS 15 top-hat rail. For example, small terminal blocks can firstly be snapped onto the TS 15 and then this rail can be attached to the TS 32 using the sliding nuts.

ADP

Cover strips

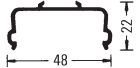

Material: unplasticised PVC
 Supplied in 1 m lengths
 Temperature limit: max. 70 °C

transparent Type	Order No.
ADP 1 	0485200000
ADP 2 	0485300000
ADP 3 	0485400000
ADP 4 (1000 mm) 	1430760000

transparent Type	Order No.
ADP 4 (300 mm) 	1378160000

HP

Retaining plates

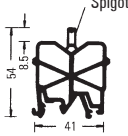
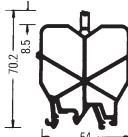
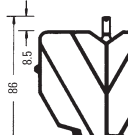
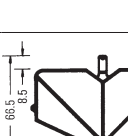

Material: PA 66
 Thickness: 2 mm

For mounting on TS 35 / TS 32, with spigot for lead seal Type	Order No.
HP 1 	0485560000
HP 2 	0485660000
HP 3 	0485760000
HP 4 	0485860000

Covers

Overall dimensions	A	A	A	A	B	C
for mounting on terminal rails	TS 32	TS 35 x 7.5	TS 35 x 15	TS 15		
ADP 1, HP 1	61	56	63		49	6
ADP 2, HP 2	77	72	79		62.5	6
ADP 3, HP 3	94	89	86		92	6
ADP 3, HP 4	73.5	68.5	75.5		92	6
Marking materials	Type	Qty.	Order No.			
Card with warning "lightning flash", self adhesive 20 pcs. per card	BEZ-KARTE ADP	10	0566700000			

Phase rails with pin and fork contact

For simple and safe potential distribution on installation devices

To avoid additional wiring work, phase rails are used for potential distribution in industrial plants and especially in the building industry. They are used for potential distribution to other components in the control cabinet such as circuit breakers, residual current circuit breakers and other installation devices. In addition to the number of poles and the cross section, a distinction is also made in terms of the type of connection, provided either with bar or fork-type.

Our promise

Our range of busbars includes versions from 1-pole to 4-pole with bar and fork type variants. Tests according to DIN EN 61439-1 and DIN EN 61439-6 Stds. guarantee maximum product application safety. A corresponding range of accessories such as power supply modules, end caps and covers completes the product portfolio. Once the phase rails have been cut to length, the end caps ensure the required creepage distances in the system and guarantee finger safety in accordance with DIN EN 50274. Various feed modules facilitate handling when feeding the system.

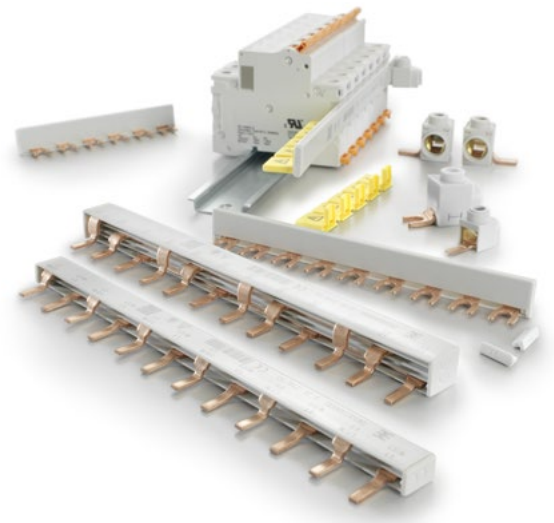

Our installation tip

- Always use end caps after cutting the busbars to length to ensure finger safety according to DIN EN 50274
- Lateral feed via the Fit 50... reduces the bending radius of the supply cable and thus simplifies wiring
- Protection cover indicate contact points not yet connected

Current rating

	1-phase						2,3 and 4-phase			
Busbar cross-section in mm ²	0	12	16	20	25	36	10	16	25	36
Feed-in from side maximum busbar current I_S / Phase A	36	65	80	90	100	130	63	80	100	130
Feed-in from middle maximum current per branch I_E / Phase A	100	110	130	150	180	220	100	130	180	220
maximum feed-in current I_E / Phase A										

Feed-in at start of busbar

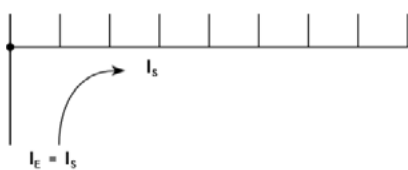

Feeding along the busbar or central feed-in

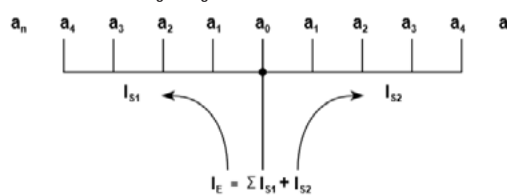

For central supply, it has to be made sure that the sum of the outgoing currents a_0 at each bus branch is not bigger than the above-mentioned max. busbar current I_S / phase

**Single phase rails for LS, LS + HI and DO
1-pin Fork (M6)**

- Can be cut to any length
- Finger safe according to DIN EN 50274



Type	for wire cross-section	Rated current	Poles	Pitch	Qty.	Order No.
G-1L-106/10	10 mm ²	63 A	6	17.80 mm	10	2657770000
G-1L-106/16	16 mm ²	80 A	6	17.80 mm	10	2657780000
G-1L-160/10	10 mm ²	63 A	9	17.80 mm	10	2657790000
G-1L-160/16	16 mm ²	80 A	9	17.80 mm	10	2657800000
G-1L-210/10	10 mm ²	63 A	12	17.80 mm	10	2657810000
G-1L-210/16	16 mm ²	80 A	12	17.80 mm	10	2657820000
G-1L-268/10	10 mm ²	63 A	15	17.80 mm	10	2657830000
G-1L-268/16	16 mm ²	80 A	15	17.80 mm	10	2657840000
G-1L-320/10	10 mm ²	63 A	18	17.80 mm	10	2657850000
G-1L-320/16	16 mm ²	80 A	18	17.80 mm	10	2657860000
G-1L-1000/10	10 mm ²	63 A	57	17.80 mm	10	2657870000
G-1L-1000/16	16 mm ²	80 A	57	17.80 mm	10	2657880000
G-1L+9-1000/10	10 mm ²	63 A	37	17.80 mm	10	2657890000
G-1L+9-1000/16	16 mm ²	80 A	37	17.80 mm	10	2657900000
G-1L-27-1000/10	10 mm ²	63 A	37	27.00 mm	10	2657910000
G-1L-27-1000/16	16 mm ²	80 A	37	27.00 mm	10	2657920000

**Accessories
End cap EK 1**



Type	Qty.	Order No.
END CAP G+S 1L/10-16	50	2658970000

Busbars and accessories

Single phase rails for LS, LS + HI and DO

1-pole Pin

- Can be cut to any length
- Finger safe according to DIN EN 50274



Type	for wire cross-section	Rated current	Poles	Pitch	Qty.	Order No.
S-1L-106/10	10 mm ²	63 A	6	17.80 mm	10	2657930000
S-1L-106/16	16 mm ²	80 A	6	17.80 mm	10	2657940000
S-1L-160/10	10 mm ²	63 A	9	17.80 mm	10	2657950000
S-1L-160/16	16 mm ²	80 A	9	17.80 mm	10	2657960000
S-1L-210/10	10 mm ²	63 A	12	17.80 mm	10	2657970000
S-1L-210/16	16 mm ²	80 A	12	17.80 mm	10	2657980000
S-1L-268/10	10 mm ²	63 A	15	17.80 mm	10	2657990000
S-1L-268/16	16 mm ²	80 A	15	17.80 mm	10	2658000000
S-1L-320/10	10 mm ²	63 A	18	17.80 mm	10	2658010000
S-1L-320/16	16 mm ²	80 A	18	17.80 mm	10	2658020000
S-1L-1000/10	10 mm ²	63 A	57	17.80 mm	10	2658030000
S-1L-1000/16	16 mm ²	80 A	57	17.80 mm	10	2658040000
S-1L+9-1000/10	10 mm ²	63 A	37	17.80 mm	10	2658050000
S-1L+9-1000/16	16 mm ²	80 A	37	17.80 mm	10	2658060000
S-1L-27-1000/10	10 mm ²	63 A	37	27.00 mm	10	2658070000
S-1L-27-1000/16	16 mm ²	80 A	37	27.00 mm	10	2658080000

Accessories

End cap EK 1



Type	Qty.	Order No.
END CAP G+S 1L/10-16	50	2658970000

**Single phase rails for LS, LS + HI and DO
2-pin Fork (M6)**

- Can be cut to any length
- Finger safe according to DIN EN 50274

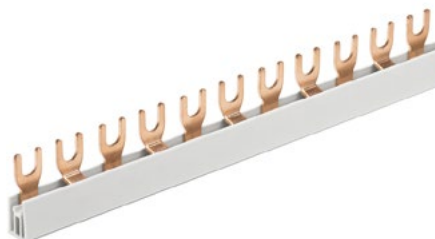

Type	for wire cross-section	Rated current	Poles	Pitch	Qty.	Order No.
G-2L-106/10	10 mm ²	63 A	6	17.80 mm	5	2658090000
G-2L-106/16	16 mm ²	80 A	6	17.80 mm	5	2658100000
G-2L-210/10	10 mm ²	63 A	12	17.80 mm	5	2658110000
G-2L-210/16	16 mm ²	80 A	12	17.80 mm	5	2658120000
G-2L-320/10	10 mm ²	63 A	18	17.80 mm	5	2658130000
G-2L-320/16	16 mm ²	80 A	18	17.80 mm	5	2658140000
G-2L-1000/10	10 mm ²	63 A	56	17.80 mm	5	2658150000
G-2L-1000/16	16 mm ²	80 A	56	17.80 mm	5	2658160000
G-2L+9-1000/10	10 mm ²	63 A	46	17.80 mm	5	2658170000
G-2L+9-1000/16	16 mm ²	80 A	46	17.80 mm	5	2658180000
G-2L-27-1000/10	10 mm ²	63 A	38	27.00 mm	5	2658190000
G-2L-27-1000/16	16 mm ²	80 A	38	27.00 mm	5	2658200000

**Accessories
End cap EK 1**



Type	Qty.	Order No.
END CAP G+S 2L/10	10	2658980000
END CAP G+S 2L/16	10	2658990000

Busbars and accessories

Single phase rails for LS, LS + HI and DO 2-pole Pin

- Can be cut to any length
- Finger safe according to DIN EN 50274

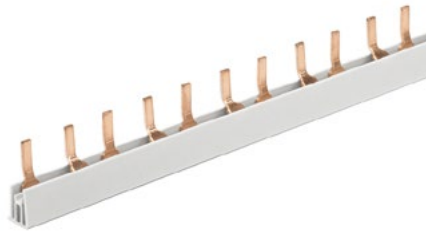

Type	for wire cross-section	Rated current	Poles	Pitch	Qty.	Order No.
S-2L-106/10	10 mm ²	63 A	6	17.80 mm	5	2658210000
S-2L-106/16	16 mm ²	80 A	6	17.80 mm	5	2658220000
S-2L-210/10	10 mm ²	63 A	12	17.80 mm	5	2658230000
S-2L-210/16	16 mm ²	80 A	12	17.80 mm	5	2658240000
S-2L-320/10	10 mm ²	63 A	18	17.80 mm	5	2658250000
S-2L-320/16	16 mm ²	80 A	18	17.80 mm	5	2658260000
S-2L-1000/10	10 mm ²	63 A	56	17.80 mm	5	2658270000
S-2L-1000/16	16 mm ²	80 A	56	17.80 mm	5	2658280000
S-2L+9-1000/10	10 mm ²	63 A	46	17.80 mm	5	2658290000
S-2L+9-1000/16	16 mm ²	80 A	46	17.80 mm	5	2658300000
S-2L-27-1000/10	10 mm ²	63 A	38	27.00 mm	5	2658310000
S-2L-27-1000/16	16 mm ²	80 A	38	27.00 mm	5	2658320000

Accessories

End cap EK 1



Type	Qty.	Order No.
END CAP G+S 2L/10	10	2658980000
END CAP G+S 2L/16	10	2658990000

Single phase rails for LS, LS + HI and DO 3-pin Fork (M6)

- Can be cut to any length
- Finger safe according to DIN EN 50274

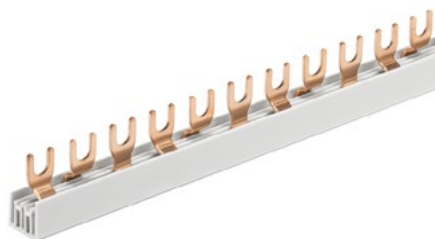

Type	for wire cross-section	Rated current	Poles	Pitch	Qty.	Order No.
G-3L-106/10 C	10 mm ²	63 A	6	17.80 mm	5	2658330000
G-3L-106/16 C	16 mm ²	80 A	6	17.80 mm	5	2658340000
G-3L-160/10 C	10 mm ²	63 A	9	17.80 mm	5	2658350000
G-3L-160/16 C	16 mm ²	80 A	9	17.80 mm	5	2658360000
G-3L-210/10 C	10 mm ²	63 A	12	17.80 mm	5	2658370000
G-3L-210/16 C	16 mm ²	80 A	12	17.80 mm	5	2658380000
G-3L-268/10 C	10 mm ²	63 A	15	17.80 mm	5	2658390000
G-3L-268/16 C	16 mm ²	80 A	15	17.80 mm	5	2658400000
G-3L-320/10 C	10 mm ²	63 A	18	17.80 mm	5	2658410000
G-3L-320/16 C	16 mm ²	80 A	18	17.80 mm	5	2658420000
G-3L-375/10 C	10 mm ²	63 A	21	17.80 mm	5	2658430000
G-3L-375/16 C	16 mm ²	80 A	21	17.80 mm	5	2658440000
G-3L-1000/10 C	10 mm ²	63 A	57	17.80 mm	5	2658450000
G-3L-1000/16 C	16 mm ²	80 A	57	17.80 mm	5	2658460000
G-3L+9-1000/10 C	10 mm ²	63 A	48	17.80 mm	5	2658470000
G-3L+9-1000/16 C	16 mm ²	80 A	48	17.80 mm	5	2658480000
G-3L-27-1000/10	10 mm ²	63 A	36	27.00 mm	5	2658490000
G-3L-27-1000/16	16 mm ²	80 A	36	27.00 mm	5	2658500000

Accessories

End cap EK 1



Type	Qty.	Order No.
END CAP G+S 3L/10	10	2659000000
END CAP G+S 3L/16	10	2659600000

Busbars and accessories

Single phase rails for LS, LS + HI and DO

3-pole Pin

- Can be cut to any length
- Finger safe according to DIN EN 50274

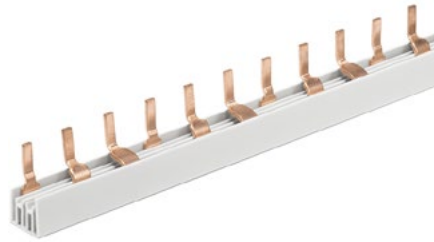

Type	for wire cross-section	Rated current	Poles	Pitch	Qty.	Order No.
S-3L-106/10	10 mm ²	63 A	6	17.80 mm	5	2658510000
S-3L-106/16	16 mm ²	80 A	6	17.80 mm	5	2658520000
S-3L-160/10	10 mm ²	63 A	9	17.80 mm	5	2658530000
S-3L-160/16	16 mm ²	80 A	9	17.80 mm	5	2658540000
S-3L-210/10	10 mm ²	63 A	12	17.80 mm	5	2658550000
S-3L-210/16	16 mm ²	80 A	12	17.80 mm	5	2658560000
S-3L-268/10	10 mm ²	63 A	15	17.80 mm	5	2658570000
S-3L-268/16	16 mm ²	80 A	15	17.80 mm	5	2658580000
S-3L-320/10	10 mm ²	63 A	18	17.80 mm	5	2658590000
S-3L-320/16	16 mm ²	80 A	18	17.80 mm	5	2658600000
S-3L-375/10	10 mm ²	63 A	21	17.80 mm	5	2658610000
S-3L-375/16	16 mm ²	80 A	21	17.80 mm	5	2658620000
S-3L-1000/10	10 mm ²	63 A	57	17.80 mm	5	2658630000
S-3L-1000/16	16 mm ²	80 A	57	17.80 mm	5	2658640000
S-3L+9-1000/10	10 mm ²	63 A	48	17.80 mm	5	2658650000
S-3L+9-1000/16	16 mm ²	80 A	48	17.80 mm	5	2658660000
S-3L-27-1000/10	10 mm ²	63 A	36	27.00 mm	5	2658670000
S-3L-27-1000/16	16 mm ²	80 A	36	27.00 mm	5	2658680000

Accessories

End cap EK 1



Type	Qty.	Order No.
END CAP G+S 3L/10	10	2659000000
END CAP G+S 3L/16	10	2659600000

**Single phase rails for LS, LS + HI and DO
4-pin Fork (M6)**

- Can be cut to any length
- Finger safe according to DIN EN 50274

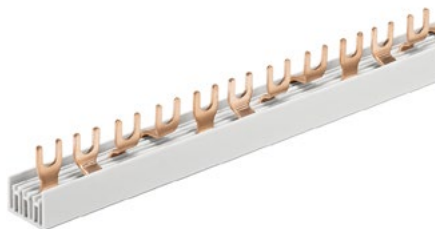

Type	for wire cross-section	Rated current	Poles	Pitch	Qty.	Order No.
G-4L-140/10 C	10 mm ²	63 A	8	17.80 mm	5	2658690000
G-4L-140/16 C	16 mm ²	80 A	8	17.80 mm	5	2658700000
G-4L-210/10 C	10 mm ²	63 A	12	17.80 mm	5	2658710000
G-4L-210/16 C	16 mm ²	80 A	12	17.80 mm	5	2658720000
G-4L-285/10 C	10 mm ²	63 A	16	17.80 mm	5	2658730000
G-4L-285/16 C	16 mm ²	80 A	16	17.80 mm	5	2658740000
G-4L-1000/10 C	10 mm ²	63 A	56	17.80 mm	5	2658750000
G-4L-1000/16 C	16 mm ²	80 A	56	17.80 mm	5	2658760000
G-4L+9-1000/10 C	10 mm ²	63 A	36	17.80 mm	5	2658770000
G-4L+9-1000/16 C	16 mm ²	80 A	48	17.80 mm	5	2658780000
G-1L+N-2L+N-3L+N-1000/10 C	10 mm ²	63 A	54	17.80 mm	5	2658790000
G-1L+N-2L+N-3L+N-1000/16 C	16 mm ²	80 A	54	17.80 mm	5	2658800000
G-1L+N+9-2L+N+9-3L+N+9-1000/10 C	10 mm ²	63 A	42	17.80 mm	5	2658810000
G-1L+N+9-2L+N+9-3L+N+9-1000/16 C	16 mm ²	80 A	42	17.80 mm	5	2658820000

**Accessories
End cap EK 1**



Type	Qty.	Order No.
END CAP G+S 4L/10	10	2659010000
END CAP G+S 4L/16	10	2659030000

Busbars and accessories

Single phase rails for LS, LS + HI and DO 4-pole Pin

- Can be cut to any length
- Finger safe according to DIN EN 50274

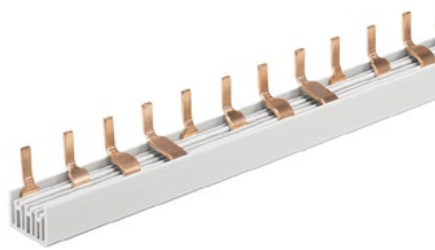

Type	for wire cross-section	Rated current	Poles	Pitch	Qty.	Order No.
S-4L-140/10	10 mm ²	63 A	8	17.80 mm	5	2658830000
S-4L-140/16	16 mm ²	80 A	8	17.80 mm	5	2658840000
S-4L-210/10	10 mm ²	63 A	12	17.80 mm	5	2658850000
S-4L-210/16	16 mm ²	80 A	12	17.80 mm	5	2658860000
S-4L-285/10	10 mm ²	63 A	16	17.80 mm	5	2658870000
S-4L-285/16	16 mm ²	80 A	16	17.80 mm	5	2658880000
S-4L-1000/10	10 mm ²	63 A	56	17.80 mm	5	2658890000
S-4L-1000/16	16 mm ²	80 A	56	17.80 mm	5	2658900000
S-4L+9-1000/10	10 mm ²	63 A	36	17.80 mm	5	2658910000
S-4L+9-1000/16	16 mm ²	80 A	48	17.80 mm	5	2658920000

Accessories

End cap EK 1



Type	Qty.	Order No.
END CAP G+S 4L/10	10	2659010000
END CAP G+S 4L/16	10	2659030000

Feed-in terminals
Fork and Pin design

- Quick mounting
- Safe contact due to screw clamping
- No special tool required for crimping cable lugs
- Finger safe according to DIN EN 50274
- Universal feed directions (frontal/lateral)



Type	for wire cross-section	Version	Width / Height / Depth	Rated current	Qty.	Order No.
FIT 25 GN	25 mm ²	Fork	13.5 / 34 / 19.5 mm	101 A	10	2659050000
FIT 25 SN	25 mm ²	Pin	13.5 / 35.5 / 19.5 mm	101 A	10	2659060000
FIT 50 GN	50 mm ²	Fork	17.8 / 39.7 / 27 mm	150 A	3	2659070000
FIT 50 SN	50 mm ²	Pin	17.8 / 39.7 / 27 mm	150 A	3	2659080000
FIT 50 GN/F	50 mm ²	Fork	17.8 / 39.7 / 27 mm	150 A	3	2659090000
FIT 50 SN/F	50 mm ²	Pin	17.8 / 39.7 / 27 mm	150 A	3	2659100000

Accessories

Protection Cover for fork and pin suitable for busbars

- Busbar type: 1 - 4 phase fork and pin
- Module width (step): 17.6 - 18 mm (individually detachable)



Type	Qty.	Order No.
PROTECTION COVER G+S /5	10	2659040000

Systemised marking

For optimised processes

Your primary expectation of a marking system is that it clearly shows how your components are configured. This includes an accurate printed image, ease of use and usability in an industrial environment. You need data entry and administration software to provide optimum support. During marker output, the speed should be adaptable to your needs. In order to provide the right marking solution for all products at all time, we have built up a unique overall system of markers, printers and software. The tailored range of products ensures precise identification throughout the whole panel – or, for short, systemised marking.

Our promise

Our harmonised system of software, markers and printers allows you to optimise processes – from entering your data to the finished marker for the individual panel configuration. You have a clear overview to allow clear identification of panel components.

More detailed information on our marking system is available at www.weidmueller.com/markung

Order data is available in our online catalogue.

Flexible printing on plastic and metal markers with inkjet printer

The MultiCard concept is our standard for modern, innovative identification and marking systems. With over 270 variants, it offers neutral plastic markers in a standardised card format for all Weidmüller terminal blocks and terminal blocks from other manufacturers. We also offer the appropriate marker options for the simple and quick connection of conductors, cables and devices.

Use our PrintJet CONNECT inkjet printer for quick clear labelling of large volumes. Its precise colouring and thermal fixing ensure continuous and robust identification. MetalliCard formats made of aluminium and stainless steel can also be printed just as securely. Its wide range of applications and flexibility allows this printer to provide standard-compliant and efficient marking. Depending on the requirements, it is operated either with our user-friendly planning software M-Print® PRO or as a standalone solution with saved templates using a USB stick.



Endless marking with MultiMark and the thermo-transfer printer

The MultiMark terminal markers are endless material with a special stamped pattern. This means they can be rotated easily, which is ideal for compensating tolerances in long terminal blocks. The MultiMark formats are printed using the compact, modular THM MultiMark thermo-transfer printer which offers high levels of flexibility. The optional cutting and perforation option enables the endless material to be cut to any length. This makes cutting and assigning the relevant labels very simple. The THM MultiMark is also the ideal printer when it comes to printing fabric and polyester labels, shrink sleeves and PLC labels. The major benefit: you can make all the labels in and around the panel using just one printer.

Highlight

The THM MultiMark thermo-transfer printer is a compact all-rounder with an intuitive touch-screen display and status indicator, making it easy to operate in 22 languages. Its compact design and weight of just 3.5 kg means it can also be easily used outside the workshop.

Made for professional work

One-stop shopping for quality tools

You need them for wiring and testing, for commissioning and maintenance – tools are a constant companion when it comes to panel building. They need to sit well in the hand and guarantee consistently high workmanship even after many working cycles. Our quality tools are a choice that will bring you happiness for a long time. Our range includes proficient manual tools for cutting, stripping, crimping, testing and screwing, as well as machines and accessories. From installation of the terminal blocks to installation of delicate electronic components, you can find the right tool for all applications from us.

Our promise

Weidmüller tools were developed with the aim of making your work easier, optimising working processes and thus increasing productivity in panel building. The perfect coordination of terminal blocks, wire-end ferrules and conductors guarantees the best possible working results.

Detailed information on our range of tools is available at www.weidmueller.com/tools

Order data is available in our online catalogue.

The right quality tool for every stage of the process

Cutting

With our robust cutting tools, you can rely on smooth, straight cuts with no deformation of the conductor. Whether you need to cut copper or aluminium cables with small or large cross-sections, the mechanical drive and specific cutting shape allow really ergonomic work.

Stripping

Our precision tools specialise in stripping and sheath stripping of cables to guarantee reliable results. The wide product range is perfectly tailored to insulation and the wire cross-section and guarantees perfect wiring for all sorts of cable types.

Crimping

Our selection of crimping tools fits a wide range of conductors, wire-end ferrules and contacts. This ensures optimum processing quality in all applications. The result is stable, long-lasting connections which meet all relevant international standards and regulations.

Testing and measuring

From voltage testers through clamp-on meters, use our complete range of testing and measuring instruments for precise results. Besides the highest possible reliability for optimum application protection, the devices provide impressively easy handling.

Pliers

Our range of ESD pliers meets all national and international testing standards. The special material of the handles prevents electrostatic discharge. And the ergonomic design of the pliers allows fatigue-free work.



Screwing

High torques and optimum transfer of axial force – our manual and battery-powered torque screwdrivers enable exact, effective work with high levels of repeat accuracy. They are available in four sizes to fit all hands and requirements.

Automatic machines

Automating individual work stages such as cutting to length, stripping and crimping helps increase efficiency. With our robust, user-friendly machines for cable processing, you reduce installation times and minimise production costs.

Wire-end ferrules and cable connectors

With our wire-end ferrules and insulated cable connectors, you guarantee safe connections in the long term. We provide these accessories to match our components and tools in various versions and colour alternatives.

Highlight

Real added value for you: you can have your tools regularly tested and maintained in our in-house tool certification office. This allows you to guarantee consistent functionality and quality.

For every industry and every application

Klippon® Protect enclosure system

gives safety and protection to connection solutions

Enclosures fulfil an important safety function and prove their worth every day, even under the toughest of conditions. All industries have their own specific requirements in terms of enclosure technology – from machine construction through transport and energy engineering to the process industry. With Klippon® Protect, you can choose from a wide range of universal and application-specific enclosures. These products cover all relevant approvals required for use in industrial and explosive risk zones. They are flexible enough for optimal adaptation to your requirements.

Our promise

The flexible Klippon® Protect enclosure system is the perfect addition to our Klippon® Connect range of terminal blocks. You can rely on our assembled enclosures to offer a custom fit to your requirements and provide excellent protection. Klippon® Services completes our products range with optimal support for your processes.

More detailed information on our wide range of Klippon® Protect enclosure systems can be found at www.weidmuller.com/klipponprotect

Universal range

The universal enclosures Klippon® Protect are made of stainless steel, aluminium, or plastic. Either one guarantees excellent protection for your assembly. With these robust enclosures, you can implement various field applications to suit your requirements. The matching system accessories enable simple integration, expansion, and customisation.

Application range

Our Klippon® Protect application range provides solutions for monitoring and safety, measurement and control technology, and power distribution. These application solutions are based on high quality and comprehensive approvals for explosive risk zones.

You can obtain distribution boxes, terminal boxes or command and signalling devices as well from a single source in a consistent enclosure design for maximal safety, reliable functionality and low follow-up costs for maintenance, replacement and storage.



Klippon® Services

Klippon® Services combines consultancy, planning, application expertise and industry know-how. You benefit from our one-stop production services. Thereby you will reduce costs, increase efficiency, and simplify quality management. We guarantee quick, quality-focused production and order-based availability. We deliver even individually assembled products anywhere within a short time.



Configuration and ordering are simple with the Weidmüller Configurator www.weidmueller.de/wmc



Highlight

Our Fast Delivery Service is a real highlight of our service range that offers to easily configure and request assembled terminal strips, empty or assembled enclosures with the Weidmüller Configurator WMC. The offer is provided within just a few minutes including order numbers for direct ordering - available 24/7. An order will be dispatched from Germany after just four days when a certain service level is selected. Order quantities start at one.

Environmental Product Compliance & Declaration of Conformity

When selecting and procuring materials, we apply the highest quality standards and adhere to international standards and regulations. In this way, Weidmüller, as a value-oriented company, fulfills its responsibility as an environmentally conscious company.

Quality management systems DIN EN ISO 9001

In order to always deliver first-class products, the highest level of quality assurance is essential for us. Starting with the quality management of our products based on ISO 9000 ff. through to permanent monitoring by independent institutes who monitor our production facilities, as well as quality management and our in-house laboratory. You therefore benefit from maximum reliability and durability!



RoHS

The restriction of lead and nine other potentially hazardous substances in electrical and electronic equipment is specified by the EU-Directive RoHS. As a value-oriented company, Weidmüller assumes its responsibility within the framework of the RoHS Directive 2011/65/EU.

China RoHS

Under the auspices of the Chinese Ministry MIIT, the new China RoHS Directive (SJ/T 11364-2014) was published on January 21, 2016. Weidmüller products are also partly subject to this directive. The new directive came into force on July 1, 2016 and is largely analogous to the EU RoHS Directive.

REACH

The European Chemical Regulation REACH stands for registration, evaluation and authorization of chemicals. As an environmentally conscious company Weidmüller takes its responsibility for communication within the supply chain and for the entire information flow within the REACH regulation.

WEEE

The sale, return and proper disposal of waste electrical and disposal of waste electrical and electronic equipment within the European the European currency area is governed by the WEEE Directive (Waste of Electrical and Electronic Equipment) 2012/19/EU. It is the aim of this directive to contribute to sustainable development in the long term.

Metals

The metals we use are selected and processed with their surfaces treated according to the latest technical knowledge. In addition, our welding area is certified in accordance with DIN EN ISO 3834-3 for fusion welding of metal-based materials.

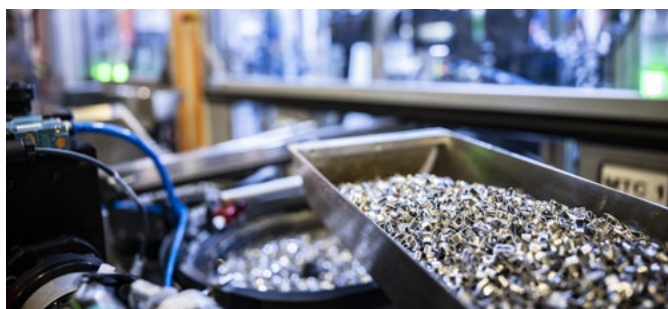

Steels

Steel ensures mechanical stability for all our connection systems. In order to permanently maintain the contact force, the steel parts are electrogalvanised and provided with additional passivation by means of a chromate layer. The advantage of surface protection with zinc lies in the high corrosion protection effect. It is also effective for a long time, even after the zinc coating has been partially damaged by scratches or pores. Furthermore, in the presence of an electrolyte, zinc acts as a cathode (i.e. negative) with respect to steel. The metal ions of the zinc migrate to the steel. This protects the underlying material from attack.

Conductive substances

The current-carrying materials copper, brass and bronze are characterised by high conductivity plus good mechanical properties. The surfaces are usually coated with tin. Besides corrosion protection, this ensures high contactability, which leads to low contact resistance. Solder connections also have a tin layer. In order to guarantee long-term solderability, an additional nickel coating is applied to the brass parts as a diffusion barrier. The nickel coating provides effective protection against outward diffusion of zinc atoms from the brass.

Insulating materials

Insulating materials made of duroplasts such as gemin (KrG) and epoxy resin (EP), but also ceramics, exhibit increased dimensional stability. They are used in products for special industries with harsh environmental conditions and increased safety requirements. These include, for example, an increased continuous operating temperature, inherent flame protection, high fire resistance or also high chemical stability.

Properties Ceramic and Duroplasts

Properties		Ceramic	Duroplasts	
Properties		Ceramic	Gemin KrG	Epoxy resin (EP)
Volume resistance acc. to IEC 60093	$\Omega \times \text{cm}$	-	10^{11}	10^{14}
Dielectric strength acc. to IEC 60243-1	kV/mm	> 10	10	160
Tracking resistance (A) acc. to IEC 60112	CTI	≥ 600	≥ 600	≥ 600
Upper max. permissible limit temperature	$^{\circ}\text{C}$	250	130	160
Lower max. permissible limit temperature (static)	$^{\circ}\text{C}$	-60	-60	-60
Flammability acc. to UL 94		V-0 (5 V-B)	V-0 (5 V-A)	V-0

Ceramic

Ceramic

Ceramic is an excellent material for electronics because it meets all requirements. Ceramic is heat resistant, water repellent, spark resistant and certified against leakage current. Thanks to its high mechanical strength, low loss factor and high heat resistance, the material has a high chemical stability and is favoured because of its minimal wear.

- Top continuous operating temperature
- High fire resistance
- Liquid-repellent
- High tracking resistance
- Inherent flame protection



Duroplasts

Duroplasts have high dimensional stability, low water absorption, extremely good tracking resistance and outstanding fire resistance. The continuous operating temperature is higher than that of thermoplastics. The deformation resistance of the duroplasts under elevated thermal load is better than for thermoplastics. A disadvantage compared with thermoplastics is the low flexibility of duroplasts.

Gemin KrG

KrG is a flame-retardant duroplast with high dimensional stability and extremely good tracking resistance. Compared with thermoplastics, KrG absorbs only a very small amount of water from the air. This property makes it suitable for use of the terminal blocks in offshore installations or shipbuilding.

- High constant operating temperature
- High fire resistance
- High tracking resistance
- Inherent flame protection
- Halogen-free flame retardant material



Epoxy resin (EP)

Epoxy resin has extremely good tracking resistance and is also heat resistant. The special feature of the epoxy resin is its resistance to nuclear radiation. This property makes the terminal blocks suitable for use in nuclear power plants.

- Very good electrical properties
- Very high constant operating temperature
- Resistant against high-energy radiation
- Halogen and phosphorous-free flame retardant



Insulating materials

Insulating materials made of thermoplastics such as polyamide (PA) or polycarbonate (PC) are easy to process. Terminal blocks consisting of an insulating material such as polyamide or polycarbonate are used in almost every industry. They have high strength and rigidity, excellent impact strength and good abrasion and wear resistance.

Properties Thermoplastics

Properties		Thermoplastics		
Properties		Wemid	Polyamid (PAGF)	Polycarbonat (PC)
Volume resistance acc. to IEC 60093	$\Omega \times \text{cm}$	10^{12}	10^{12}	10^{16}
Dielectric strength acc. to IEC 60243-1	kV/mm	25	30	≥ 30
Tracking resistance (A) acc. to IEC 60112	CTI	600	500	≥ 175
Upper max. permissible limit temperature	$^{\circ}\text{C}$	130	100	115 / 125
Lower max. permissible limit temperature (static)	$^{\circ}\text{C}$	-60	-50	-50
Flammability acc. to UL 94		V-0	HB	V-2 / V-0

Thermoplastics

Wemid

Wemid is a modified thermoplastic which has properties tailored to meet the requirements of our line connectors. Advantages over PA are the improved fire protection and the higher continuous operating temperature. Wemid meets the strict requirements for use in railway vehicles acc. to NF F 16-101.

- Higher continuous operating temperature
- Improved fire resistance
- Halogen- and phosphorous-free flame retardant
- Low smoke produced in the event of fire
- Permitted for use in railway applications acc. to NF F 16-101



Polyamide (PAGF)

Glass-fibre reinforced polyamide (PAGF) offers outstanding dimensional stability and very good mechanical properties. This makes a difference when used as an end bracket. As compared to non-reinforced PA, this material has flammability rating HB according to UL 94.

- Excellent dimensional stability
- Very good mechanical characteristics
- Halogen-free flame retardant material

**Polycarbonate (PC)**

Polycarbonate (PC) offers excellent dimensional stability and extremely good mechanical properties. Compared to polyamides, polycarbonate has a higher specific resistance. These properties are particularly suitable for large terminal blocks or terminal blocks with closely spaced potentials.

- High dimensional stability
- High continuous operating temperature
- High electrical insulation properties
- Halogen-free flame retardant material



Relevant standards – an overview

Standards have the status of a recommendation and are not legally binding. They serve to ensure the safety of systems and represent the acknowledged state of the art. We therefore always recommend compliance with the contents – irrespective of agreements and customer requirements.

The Low Voltage Directive IEC/EN 61439

Since November 2014, IEC/EN 61439 has replaced the previously applicable standard IEC/EN 60439 for low-voltage switchgear and controlgear assemblies. It comprises seven parts:

1. General rules for low-voltage switchgear and controlgear assemblies (SCA)
2. Power switchgear and controlgear assemblies (PSC)
3. Distribution boards
4. Assemblies for construction sites
5. Cable distribution cabinets
6. Busbar distribution systems
7. Assemblies for marinas, camping sites, electric vehicles charging stations (preliminary standard)

In order to confirm compliance with IEC/EN 61439, it is important that you always refer to Part 1 and one of the following parts. The standard is addressed to every manufacturer and operator of switchgear and controlgear assemblies (SCA) up to 1,000 V AC and 1,500 V DC. Irrespective of whether you assemble the SCA stationary or mobile, with or without enclosure system.

The low-voltage switchgear standard IEC/EN 60947-1

This standard applies for industrial low-voltage switchgear assemblies used in circuits up to 1,000 V AC or 1,500 V DC. It defines the general rules and requirements for low-voltage switchgear assemblies. This includes, for example, the definition, characteristic features, information to be supplied, normal conditions for operation, installation and transport as well as requirements for the construction and verification of characteristic features and behaviour.

Interaction between the standards

IEC/EN 61439 for switchgear and controlgear assemblies

With the withdrawal of the previous version on 23 September 2014, the DIN EN 61439: 20 0-06 standard for "Low-voltage switchgear and controlgear assemblies" – Part 1: General rules became binding for the switchgear and controlgear assemblies defined. This standard includes a series of changes that you have to consider as a switchgear manufacturer. However, these changes have no direct influence on the components, such as terminal blocks, which have to comply with the relevant product standard.

The importance of DIN EN 61439 for components

Components that meet the requirements of the applicable product standard are suitable for direct use in switchgear systems. They must, however, take the definitions of standard series DIN EN 61439 into consideration.

The properties required from DIN EN 61439-1 are covered by the product standard for terminal blocks EN 60947-7-1(2, 3). As an aid for the required design verification for switchgear and controlgear assemblies, the following table provides you with further information on terminal blocks. Additional design verification is not required for individual items of equipment or components.

Summarised

- IEC/EN 61439 is a new series of standards for the construction of switchgear and controlgear systems
- With the design verification, you as the manufacturer provide evidence for the suitability of the system
- You still confirm conformity with the standard by signing the EC Declaration of Conformity

Low-voltage switchgear and controlgear assembly

Original manufacturer

1.

Design verification

A combination of the variants is also conceivable

Variant 1: **Testing**

Variant 2: **Appraisal (incl. calculation)**

Variant 3: **Comparison with reference construction**

Low-voltage switchgear and controlgear assemblies

2.

Manufacturer of the switchgear and controlgear assemblies

Switchgear manufacturer

Variant 1:
Comparison with a reference construction without changes

The manufacturer of the switchgear and controlgear assemblies does not become the original manufacturer

Variant 2:
Original system with changes

The manufacturer of the switchgear and controlgear assemblies becomes the original manufacturer

Design verification for changes

Routine verification

3.

Switchgear and controlgear assemblies ready for operation

Guidelines for the construction of a switchgear and controlgear assemblies in accordance with the standard

Checklist design verification according to IEC/EN 61439

Design verification for terminal blocks and their accessories

Nr.	Characteristics to be proved	Section	Adaptability for terminal blocks																																				
1	Strength of material and parts: <ul style="list-style-type: none"> • Corrosion resistance properties of insulation material: <ul style="list-style-type: none"> • Thermal stability • Resilience to extreme heat and fire due to internal electrical effects • Resistance to UV radiation • Lifting • Impact test • Marking 	10.2 10.2.2 10.2.3 10.2.3.1 10.2.3.2 10.2.4 10.2.5 10.2.6 10.2.7	The requirements refer exclusively to cabinets for switchgear. Terminal blocks are designated for the installation in appropriate cabinets. The requirements refer exclusively to parts of the switchgear and controlgear assembly. Inserted components like terminal blocks are not affected. Terminal blocks are designated for the installation in cabinets, thus not relevant Terminal blocks are designated for the installation in cabinets, thus not relevant Terminal blocks are designated for the installation in cabinets, thus not relevant Terminal blocks bear the inscriptions, like it is determined in section 5 of the product standard.																																				
2	Degree of protection and enclosures	10.3	Terminal blocks are designated for the installation in cabinets, thus not relevant																																				
3	Clearances	10.4	The required clearances are based on EN 60664-1 and are identical with the values for the dimensioning of terminal blocks according to EN 60947-7-1(2, 3).																																				
4	Creepage distances	10.4	The required creepage distances are based on EN 60664-1 and are identical with the values for the dimensioning of terminal blocks according to EN 60947-7-1(2, 3).																																				
5	<ul style="list-style-type: none"> • Protection against electric shock and integrity of protective circuits • Effective continuity between the exposed conductive parts of the assembly and the protective circuit • Short-circuit withstand strength of the protective circuit 	10.5 10.5.2 10.5.3	Covered by the type test for modular PE conductor terminals according to EN 60947-7-2. The quality and consistency of the PE conductor connection has to be verified by resistance measurement at the end use. Not relevant, has to be judged in the end use. PE conductor terminals are subjected to a test of short-time withstand current in the context of the type test according to EN 60947-7-2.																																				
6	Installation of equipment	10.6	Installation and tight fit of terminal blocks is secured by the requirements and relevant tests according to the product standard.																																				
7	Internal circuits and connections	10.7	Not relevant, has to be judged in the end use for terminal blocks.																																				
8	Connections for conductors inserted from outside	10.8	Secured by selection of the terminal block as well as its type test according to EN 60947-7-1(2). The final assessment has to be made in the end use.																																				
9	Insulation properties: <ul style="list-style-type: none"> • Operating frequency dielectric strength • Surge voltage strength 	10.9 10.9.2 10.9.3	Tests to the insulation properties are part of the dimensioning of type tested terminal blocks according to EN 60947-7-1(2). The verification for the switchgear and controlgear assembly takes place in the end use for the terminal blocks.																																				
10	Temperature rise limits	10.10	The rated values for terminal blocks according to EN 60947-1(2, 3) can be used for the dimensioning of the temperature rise limits. The verification has to be provided for the respective application, e.g. by measurement or calculation. The calculation of the terminal block's power dissipation can take place in the application by means of the electrical resistance as a function of current: $P_{\text{loss}} = R_{\text{max}} \cdot I^2$ Following maximum resistances per electrical potential according to EN 60947-7-1(2, 3) subject to the cross section for the terminal block are permitted: <table border="1" style="width: 100%; border-collapse: collapse;"> <tbody> <tr> <td>Cross section/mm²</td> <td>1.5</td> <td>2.5</td> <td>4</td> <td>6</td> <td>10</td> <td>16</td> <td>25</td> <td>35</td> </tr> <tr> <td>Electrical resistance/mΩ</td> <td>1.83</td> <td>1.33</td> <td>1.00</td> <td>0.78</td> <td>0.56</td> <td>0.42</td> <td>0.32</td> <td>0.26</td> </tr> <tr> <td>Cross section/mm²</td> <td>50</td> <td>70</td> <td>95</td> <td>120</td> <td>150</td> <td>185</td> <td>240</td> <td>300</td> </tr> <tr> <td>Electrical resistance/mΩ</td> <td>0.21</td> <td>0.17</td> <td>0.14</td> <td>0.12</td> <td>0.10</td> <td>0.09</td> <td>0.08</td> <td>0.06</td> </tr> </tbody> </table>	Cross section/mm ²	1.5	2.5	4	6	10	16	25	35	Electrical resistance/mΩ	1.83	1.33	1.00	0.78	0.56	0.42	0.32	0.26	Cross section/mm ²	50	70	95	120	150	185	240	300	Electrical resistance/mΩ	0.21	0.17	0.14	0.12	0.10	0.09	0.08	0.06
Cross section/mm ²	1.5	2.5	4	6	10	16	25	35																															
Electrical resistance/mΩ	1.83	1.33	1.00	0.78	0.56	0.42	0.32	0.26																															
Cross section/mm ²	50	70	95	120	150	185	240	300																															
Electrical resistance/mΩ	0.21	0.17	0.14	0.12	0.10	0.09	0.08	0.06																															
11	Short-circuit withstand strength	10.11	<p>For cross sections up to 35 mm²</p> <p>In sectors after current-limiting (5ms) protection devices <100 A (fort I_{cp} <10 kA) At an unaffected short-circuit current of the grid I_{cp} ≤ 10 kA (in front of the switchgear), a forward current I_D with maximum 17 kA will arise with an upstream protection device. According to the section 10.11.2 of EN 61439-1, the switchgear manufacturer does not have to provide evidence in this case. This requirement is fulfilled by protection devices up to 100 A equipment (application of up to 35 mm² terminal blocks).</p> <p>For cross sections from 50 mm²</p> <p>In sectors after current-limiting (5 ms) protection devices ≤ 630 A (I_{cp} > 10 kA) At an unaffected short-circuit current of the grid I_{cp} > 10 kA (in front of the switchgear), a forward current I_D will flow of up to the period of 5 ms with an upstream protection device. The switchgear manufacturer has to provide evidence for the maximum forward current I_D by declaration of the terminal block's I_{pk} (surge current strength, which the terminal block is able to conduct without being destroyed).</p>																																				
12	Electromagnetic compatibility	10.12	Not relevant, because terminal blocks are seen as passive components according to the product standard EN 60947-7-1(2, 3).																																				
13	Mechanical operation	10.13	Not relevant																																				

Technical requirements from the standards

Rated cross-section

The rated cross-section of a terminal block is the value of the connectable wire cross-section, as specified by the manufacturer. This serves as a reference for certain thermal, mechanical and electrical requirements. The rated cross-section is selected from the following standard cross-sections: 0.2 – 0.5 – 0.75 – 1.0 – 1.5 – 2.5 – 4.0 – 6.0 – 10 – 16 – 25 – 35 – 50 – 70 – 95 – 120 – 150 – 240 – 300 mm².

Terminal blocks have a rated connection capacity that is at least two levels lower than the rated cross-section. The conductors can be solid, stranded or flexible, possibly with conductor end pretreatment. The verification of the rated cross-section is performed with gauges according to IEC 60947-1.

Rated current IEC 60947-7-1

Test currents are assigned to the rated cross-sections according to IEC 60947-7-1. These rated currents cause no impermissible heat transfer to the terminal:

mm ²	1.5	2.5	4.0	6.0
A	17.5	24	32	41
mm ²	10	16	25	35
A	57	76	101	125
mm ²	50	70	95	120
A	150	192	232	269
mm ²	150	185	240	300
A	309	353	415	520

Conventional free-air thermal current (I_{th})

The conventional thermal current in free air (I_{th}) is the highest test current for heating tests of unenclosed devices (see 4.3.2.1 of IEC 60947-1.) This applies exclusively to terminal blocks with multiple connection levels (multi-tier terminals) and to test-disconnect terminal blocks for which current reduction is permissible.

Rated voltage IEC 60947-7-1

The rated voltage of a terminal block is the rated insulation voltage to which the insulation tests and creepage distances relate. It is determined analogously to IEC 60664-1.

Rated impulse withstand voltage IEC 60947-7-1

Rated impulse withstand voltage is the peak value of a surge voltage with which the terminal blocks can be subjected. The clearance distances in IEC 60947-1 and IEC 60664-1 are related to it.

Pollution severity IEC 60947-7-1

The pollution severity defines the influence of solid, liquid or gaseous foreign matter, which may reduce the dielectric strength or the specific surface resistance. Pollution severity 3 has been specified for terminal blocks for industrial applications: conductive contamination occurs on dry, non-conductive contamination which becomes conductive as moisture condensation may also occur. The minimum air clearance measurement is defined in IEC 60947-7-1 in conjunction with the rated surge voltage.

Operating conditions

The terminal blocks can be operated under the following normal conditions:

- Ambient temperature –5 °C to +40 °C, mean value 24 h +35 °C
- Altitude up to 2000 m above sea level
- Relative humidity: 50 % at +40 °C, 90 % at +20 °C

Testing the contact security

Construction requirements

IEC 60947-7-1 requires that clamping points must ensure a reliable mechanical and electrical connection with permanent contact.

Tests

Standardised tests offer you the assurance that wired connections comply with the required conditions. IEC 60947-7-1 stipulates a series of tests for wire connections in terminal blocks. One or more terminals of a particular type are tested for agreement with certain limit values. These include:

- Insulation test
- Evidence of the voltage drop
- Testing of the short-time withstand current capacity
- Aging testing for terminal blocks with tension clamp, insulation displacement and PUSH IN connection technology

Special testing

Beyond the stipulated scope of type testing, further tests can be performed at your own discretion or in agreement with the user.

Contact security

The high level of contact security and reliability are verified with our systems using various tests (see table).

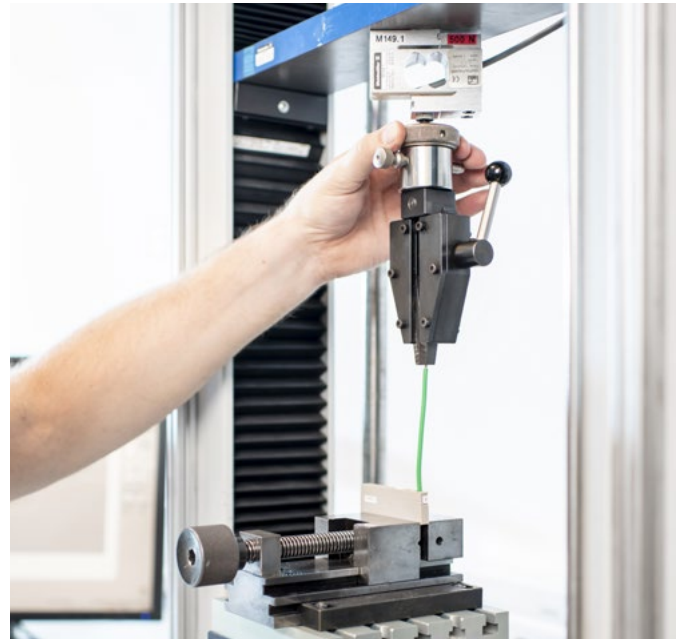

1 Type testing acc. to IEC 60947-7-1

2 Stricter Weidmüller tests

2.1 Mechanical tests:

- Vibration testing to Weidmüller requirements
- Natural resonance characteristics acc. to IEC 60068-2-6
- Shock and vibration testing acc. to BV 0440/... and BV 0430/

2.2 Environmental testing:

- Cold testing acc. to EN 60068-2-1
- Damp heat (steady state) acc. to IEC 60512-6 test 11c
- Damp heat (steady state) acc. to IEC 60068-2-30
- Damp heat (cyclic) acc. to IEC 60068-2-30
- Salt spray testing acc. to IEC 60068-2-11
- Sulphur dioxide SO₂ acc. to IEC 60068-2-42
- Hydrogen sulphide H₂S acc. to IEC 60068-2-43
- Gas tightness acc. to IEC 605 12_6_PR 11n

3 National and international approvals

4 Practice, i.e. the use of systems in harsh areas of application in industry, e.g. Ex applications

Protection against inadvertent, direct touching, of hazardous live parts

Back of hand safety according to EN 61032

Back of hand safety is satisfied if, according to EN 61032, a sphere of diameter 50 (+0.01) mm with a force of 50 (± 5) N does not touch any hazardous parts.

Actuation conditions according to IEC 60947-7-3

IEC 60947-7-3 paragraph 7.1.8 specifies that fuse terminal blocks must be constructed in such a way that live parts cannot be touched. Finger safety for live parts of the cartridge fuse must be maintained while the cartridge fuse is replaced. If it is necessary to maintain protection against electric shock, label with "line-load" or arrows that indicate the energy flow direction.

In general:

Not all installation components have to be configured touch-safe, as in the example of terminal blocks. A touch-safe construction is only required if these components are arranged in a direct radius of 30 mm around the operation elements and the system cannot be insulated (exception allowed on the basis of the construction using accessories in each case).

Principles for the use of terminal blocks in Ex-areas

Harsh industrial environments and explosive risk zones, such as in the oil and gas industry, make extreme demands on safety, robustness and quality of products and devices. Numerous standards describe what has to be considered in Ex environments. They serve as the basis for extensive approvals.



Explosion protection

Worldwide, explosion protection is essentially based on the international IEC 60079 series of standards, European and American norms, standards, and directives. In the USA, the National Electrical Code (NEC) and in Canada the Canadian Electrical Code (CEC) form the basis.

For the CENELEC countries of the European Community and beyond, Directive 2014/34/EU is of central importance for manufacturers of equipment and protective systems. The worldwide requirements are confirmed by certification according to IECEx. Thus, the application is approved in the type of protection „Increased Safety“ Ex e in Zone 1 and 2.



Terminal blocks in the Ex environment

According to EN IEC 60079-0, Ex terminal blocks are so-called Ex components. By definition, these are components that are required for the safe operation of devices and protective systems, but without performing an autonomous function themselves. They are approved for the type of protection equipment increased safety „e“ and are not marked with the CE mark according to the European ATEX directives 2014/34/ EU.

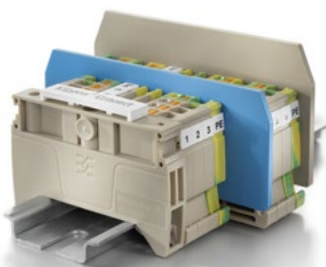

Accessories

The accessories you can use is listed in the Ex-certificates. To adhere to the creepage and clearance distances for Ex e, use terminations and partition plates. Terminal blocks for intrinsically-safe circuits “i” are passive components. Therefore, for use in intrinsically-safe circuits, you do not need a type examination certificate. We recommend blue terminals for clear identification and easy recognition. These, as well as the accessories, have to comply with the type according to EN 60079-11.

Issue of type examination certificate

Notified bodies issue EU type examination certificates in accordance with EN IEC 60079-0; EN IEC 60079-7 and the ATEX Directive. By issuing the Production Quality Assurance Notification, a notified body confirms that the requirements of the ATEX Directive according to Annexes IV and VII are met.

Requirements for terminal blocks for type of protection increased safety Ex eb

The type of protection Increased Safety "Ex eb" (IEC/EN 60079-7) is based on the principle of more stringent design measures.

The elementary points for terminal blocks are:

- Increased requirements for self-heating compared to industry standard
- Compliance of clearance and creepage distances (eb)
- The terminal block must be inserted or protected in such a way that the connection can neither become loose nor be damaged inadmissibly by the clamping point

The above points and the technical data are tested by an independent testing institute (DEKRA, PTB, TÜV...) and certified by the certificate.

The following tests must be verified by the type examination or serve as a basic requirement for an IEC Ex application:

- Type testing according to IEC 60947-7-1/-2/-3
- Verification and documentation of clearance and creepage distances
- Ageing test:
 - 14 days storage at 95 °C and 95 % humidity
 - Further 14 days at dry heat Level of the TI value of the insulating material
 - 24 hours cold storage at -65 °C (for PA66) with subsequent conductor pull-out test

Depending on the type of protection, the terminal blocks are approved for increased safety „eb" or „ec" and thus for installation in Zone 1 or Zone 2. This applies provided that the terminal blocks are installed in a terminal box.

Terminal boxes must also have the ignition protection type device protection for increased safety Ex e and must at least correspond to protection type IP54. The installation instructions must be taken into account in the application.



Ex eb

Principles for the use of terminal blocks in Ex-areas



Requirements for terminal blocks for type of protection

Equipment protection Intrinsic safety Ex i

For applications with type of protection equipment intrinsic safety Ex i, no separate approval is required for terminal blocks. In addition to the Ex e approved terminal blocks, other standard terminal blocks can also be used, whereby the following more stringent spacing requirements apply in the Ex i area:

- Between conductor entries adjacent terminals
- Between conductor entries and grounded metal parts
- Increased requirements for clearances due to solid insulation



Requirements for terminal blocks for type of protection Ex ec

When test disconnect terminal blocks or fuse terminal blocks are used, they must have approval for the type of protection for equipment protection increased safety Ex ec. In this case, increased requirements apply to the terminal blocks and their functional units. For example, all disconnectable elements must have a release force greater than 15 N or 100 times their own weight to prevent unintentional opening.



Further approvals and guidelines for the explosion protected areas

Other national and international approvals and directives are based on the IECEx approval. For example, ATEX for the European market, CCC Ex for the Chinese market, KC for the South Korean market or EAC Ex for the Eurasian Economic Union, which includes Russia, Belarus, Kazakhstan, Kyrgyzstan and Armenia.

Labeling of terminal blocks in Ex areas

The explosion-protected equipment must be marked in such a way that it is used correctly according to its safety-related properties. For terminal blocks of the type of protection increased safety „e“ there is a marking obligation. This marking of the equipment is laid down in IEC/EN 60079 Part 0 and Part 7. The exemplary marking of a terminal block can be seen in the following illustrations.

- 1 Rated cross section
- 2 Rated voltage
- 3 ATEX label
- 4 Type of protection label
- 5 ATEX certificate number
- 6 IECEx certificate number

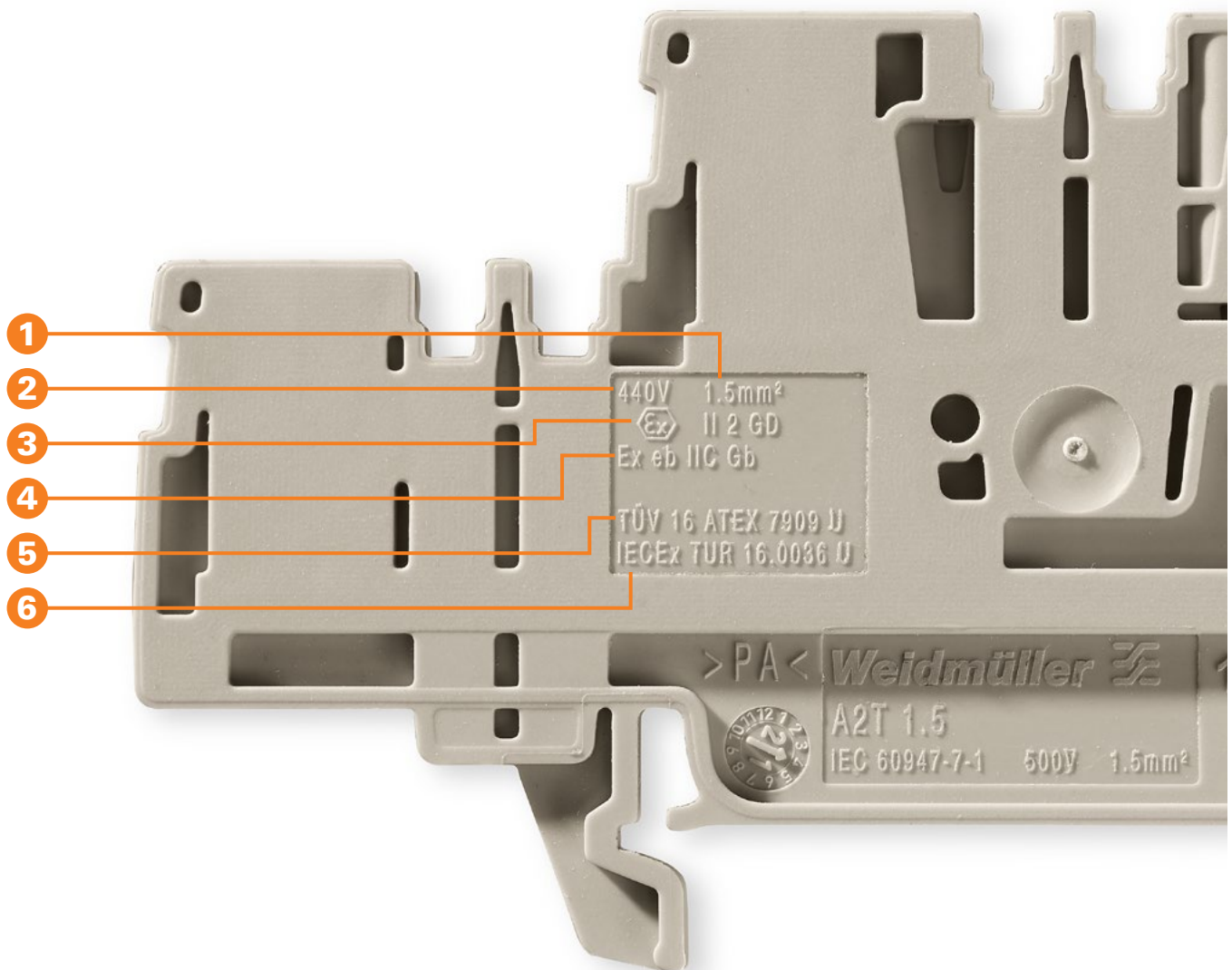

Service and support

Service and support	Service connects - worldwide	V.2
	Engineering services and customised products	V.3
	easyConnect - Your Industrial Service Platform	V.4
	Support Center	V.6
	Additional support services	V.7
	Weidmüller Configurator: intuitive, uncomplicated & fast digital engineering	V.8
	Your digital ordering options at Weidmüller	V.10

Our expertise for your requirements

Service connects – worldwide



Automation technology functions are becoming more complex in a globally-oriented world facing ambitious targets in terms of energy efficiency and smart production. We are your equal partners for the best connections in Industrial Connectivity.

Our personal support answers all questions reliably and expertly. During planning, installation or operation our service and support offer is your best companion.

In short: Weidmüller's global service combines our expertise with your requirements.



Your way to our service
www.weidmueller.com/service

Engineering services and customised products

Automation engineering and connectivity consulting belongs to our services as well as assembly of engineered products. We also support the process from the idea to the product with our Weidmüller Configurator and the Configure-to-Order process.



Consulting and engineering

The challenge for you is reducing costs and increasing efficiency. This requires intelligent, individual solutions. Whether it is modified products, pre-fitted mounting rails or complete small cabinets – our application centres provide a highly qualified custom-made engineering and production service.

Connectivity Consulting

Increase your competitiveness - supported by our experts. Our drive is to optimise your competitiveness. That's why our team of experts supports you in significantly increasing your efficiency in electrical machine design and control cabinet construction. With proven products and services from the Weidmüller portfolio – and with the experience gained from over 300 projects worldwide.

Assembled terminal rails - Flexibly designed to suit your requirements

Your processes in panel building have to be fast, flexible and productive. This is the only way you can cut your costs and increase efficiency. Depending on the application in question, you will have different requirements with respect to the engineering service, delivery speed and flexibility to be provided.

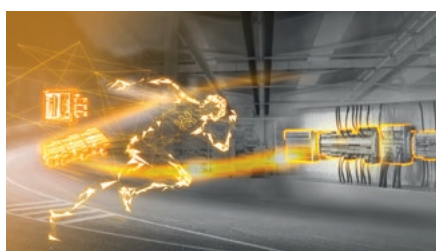

Modified and assembled enclosures - Competitive advantages included

To compete internationally, your plants need to satisfy high standards of safety, quality and performance. The smart combination of consultation, application expertise and industry know-how is our key to finding a custom-fit solution for your application. Reduce costs and increase efficiency.

Fast Delivery Service - Your ideas deserve a quick realisation

Obtain offers 24/7 and within minutes, including directly orderable article numbers with our Fast Delivery Service. The Weidmüller Configurator (WMC) for planning and configuration is key for consistent processes. Dispatch your orders in 5 days. Assemble individual terminal strips and enclosures from batch size 1!

Your ticket to the world of digital service

easyConnect – Your Industrial Service Platform



Our cloud-based platform is your ticket to the world of digital services from Weidmüller, and the intuitive and future-proof tool for your way to the Industrial IoT. Realise your use cases easily, consistently and without any relevant prior knowledge, thanks to the perfect interaction of platform, devices and diverse software services.

As an open, modular and perfectly integrable system, the platform is your enabler for a wide range of use cases. Increase your efficiency and unleash your full innovation potential with easyConnect.



Interested in using easyConnect?

Learn how to get started with easyConnect step-by-step.

www.weidmueller.com/easyconnect

Why should you use easyConnect?

- You want to enter your digital transformation step-by-step?
- You want to make the step into Industrial IOT, but have no or little IT expertise?
- You want to use your digital data for smart & scalable services?
- You want to offer digital services (such as customised dashboard) to your customers?
- You want to improve your service offering and efficiency, e.g. through remote access?
- You feel Weidmüller’s digital services are interesting, but you have „your cloud“ already?



Weidmüller comes up with the solution: easyConnect, the new digitalisation platform. It bundles Weidmüller’s digital services at one place in the cloud and connects them with various Weidmüller devices.

With easyConnect you start digitalising your application step-by-step without ballast in a secure way.

The following services are initially available on easyConnect:

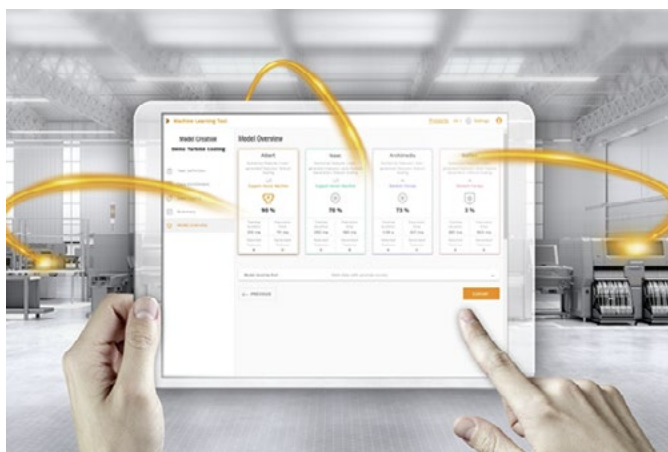

Device management

Adding and managing cloud-connected devices is typically the first step in any Industrial IoT use case.

Asset management

The asset management service is a modelling tool that allows users to model their assets and processes and link them to relevant time series data.

Remote access (u-link)

u-link guarantees a quick and secure access to machines and plants while also allowing for efficient management.

Data visualisation

easyConnect data visualisation services enable users to view, monitor and display live and historical data.

AutoML

With Weidmüller Industrial AutoML, you can optimize operations, increase product quality and develop new business models by benefiting from advanced analytics.

Expand the possibilities of our products

Our Support Center provides you with comprehensive, clear and personal assistance



Receive fast and intuitive support to get the most out of our products in your application. In our new Support Center you can search or navigate to the many application notes, product information, video tutorials or software downloads of our products.

- **Everything at a glance** – One central support hub, where all relevant information is available
- **Powerful search** – Provides filter functions for various types of information and products
- **Different views and navigations** – Content provided in views product information, engineering support or software downloads
- **More than 170,000 downloads** – Application notes, video tutorials, templates and examples, user documentation, engineering data, ...
- **Personal contact** – Direct access to your personal technical contact in your country



Additional support services

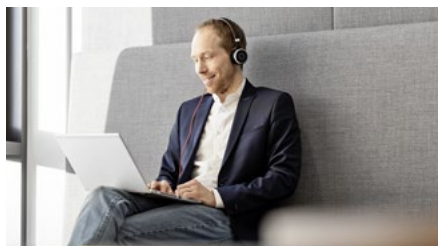

Training and Webinars

Stay tuned in a world that is accelerating. In our entertaining interactive webinars, we offer you the opportunity to learn about new products and technology topics and to interact with our experts.



Repairs and replacement parts

We offer repair and components for our Workplace Solutions as well as assistance for other Weidmüller products. Find out how our experts can help you with your repair request.



Security advisory board

Our Product Security Incident Response Team (PSIRT) continuously informs you about possible security-related vulnerabilities of our products.



Engineering data

For the quick integration of our products into your design, there are a lot of digital product data for engineering systems like EPLAN, Zuken E3.series, WSCAD and many others available for download.



Product change notifications

Technical modifications of our products always available online.



Technical product catalogues

Technical data for our entire program in Industrial Connectivity for download in PDF-format.

From the idea to the finished solution

Weidmüller Configurator: intuitive, uncomplicated & fast digital engineering

Digital engineering can be so easy – with the Weidmüller Configurator!

It's a **free to use** software application to easily configure industrial solutions. It features more than **12,000 articles** from multiple product families including rail-mounted components, industrial and ex-certified enclosures, Heavy Duty Connectors, remote I/O-systems and PCB connectors.

Unleash the full power of digital engineering:

Our application wizards help you choose the right articles.

Place, mark or modify them to your needs and get your solution **visualized in 3D** – what you see is what you get!

Our promise: Speed up your solution planning process by up to 70%!

Your benefits:

- **Proven configuration designs in real 3D:** The plausibility and collision check with the complete digital documentation ensures that you can rely 100% on your configuration.
- **Seamless E-CAD Roundtrip:** Interfaces enable the simple exchange of product data between the WMC and all common engineering tools, such as Zuken E3 or EPLAN Electric P8.
- **Sample Service & Fast Delivery Service:** to support your design-in process, we offer a **3-day sample service** for many products. Inquire them directly online – for free!
You want your solution right away? Our **Fast Delivery Service** guarantees delivery of individually assembled terminal strips or enclosures within a few days.

Get started online now!

The Weidmüller Configurator makes solution planning easy. Visit our website for more information, tutorials and download it for free:



www.weidmueller.com/wmc



or register on easyconnect.weidmueller.com and use it online.

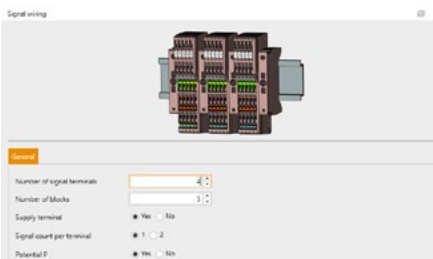

Wizards:

Design complete applications within few clicks – even without detailed product knowledge – for signal wiring, load monitoring, instrument transformers, enclosures, remote I/O-systems and many more.

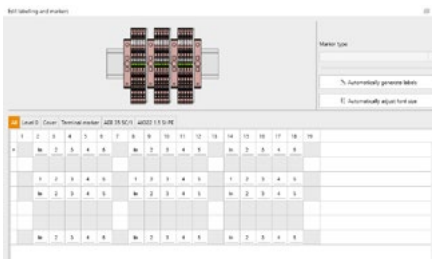

Assistants:

Finalize your solutions with supporting assistants to add cross-connectors, markers or colors and verify the faultlessness. Automatic modes save valuable time!



1-click documentation:

Get assembly drawings for production – only 1 click. Bill of material – only 1 click. The complete solution documentation including all component data sheets – you’re right, only 1 click!



Digital ordering options

Your digital ordering options at Weidmüller

Find and easily select the products you need, with convenient ordering: as your Partner in Industrial Connectivity, we know what counts in purchasing. That is why we offer you a variety of options for ordering products from us and optimising your purchasing processes to meet your individual requirements and your workflow. The choice is yours.

Order via the Weidmüller eShop

Our eShop offers you access to the complete Weidmüller product range around the clock – directly from a PC, tablet, or smartphone. The intuitive user guidance supports you as you select from over 50,000 products. Technical data, prices, and availabilities are available at any time. The shopping basket with check out function lets you place an order in seconds. Convenient additional functions like CSV upload, order history, reports, or custom order templates make your ordering processes even more efficient.

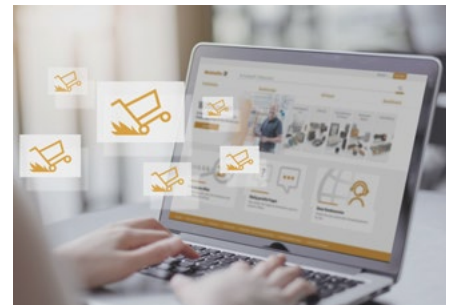

Order via the OCI interface

The Open Catalogue Interface (OCI) facilitates the exchange of data between your enterprise resource planning system and our eShop. This means that our eShop is integrated into your system via an OCI interface, so you have access to our complete product catalogue from your enterprise resource planning system. You can filter and select products, place them in your shopping basket and place direct orders without changing your software application. The open OCI standard is supported worldwide from a variety of software providers.

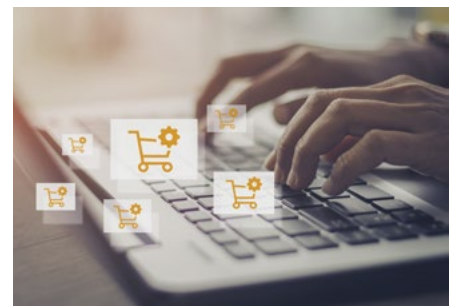

Order via the EDI interface

Our Electronic Data Interchange (EDI) also offers you the option of ordering our products directly from your enterprise resource planning system. All order data is transmitted automatically to our system and processed immediately. Orders, order confirmations, invoices, and delivery notices are transmitted lightning fast. This helps you make your purchasing processes even more efficient.

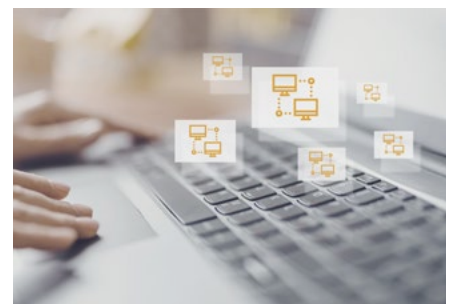

We will be glad to advise you on which solutions are suitable for you and how implementation is possible.

Get in touch with us

www.weidmueller.com/digital-order

Index

Index	Index Type	X.2
	Index Order No.	X.26
	Addresses worldwide	X.52

Type	Order No.	Page
1		
1170-21-15A	1278810000	A.189
A		
A2C 1.5	1552790000	A.16
A2C 1.5	1552790000	A.105
A2C 1.5	1552790000	A.118
A2C 1.5 BK	2508170000	A.118
A2C 1.5 BL	1552820000	A.16
A2C 1.5 BL	1552820000	A.118
A2C 1.5 BR	2508200000	A.118
A2C 1.5 DBL	2508180000	A.118
A2C 1.5 DL	2674590000	A.101
A2C 1.5 DL BL	2674600000	A.101
A2C 1.5 GN	2508210000	A.118
A2C 1.5 LTGY	2508220000	A.118
A2C 1.5 OR	1552830000	A.118
A2C 1.5 PE	1552860000	A.46
A2C 1.5 PE	1552860000	A.105
A2C 1.5 PE DL	2674610000	A.102
A2C 1.5 RD	2508200000	A.118
A2C 1.5 WT	2508160000	A.118
A2C 1.5 YL	2508190000	A.118
A2C 10	2490360000	A.25
A2C 10 BL	2490370000	A.25
A2C 10 DL	2674940000	A.101
A2C 10 DL BL	2674950000	A.101
A2C 10 FE WT	2734170000	B.251
A2C 10 FE WT	2734170000	B.253
A2C 10 PE	2490440000	A.53
A2C 10 PE DL	2674960000	A.102
A2C 150/185	2728700000	A.30
A2C 150/185	2728700000	B.20
A2C 150/185 3FT	2728760000	B.22
A2C 150/185 3FT-DM	2728830000	B.23
A2C 150/185 3FT-FE	2728750000	B.22
A2C 150/185 3FT-FE-DM	2728820000	B.23
A2C 150/185 3FT-N	2728740000	B.22
A2C 150/185 3FT-N-DM	2728810000	B.23
A2C 150/185 3FT-N-FE	2728730000	B.22
A2C 150/185 3FT-N-FE-DM	2728800000	B.23
A2C 150/185 BL	2728710000	A.30
A2C 150/185 BL	2728710000	B.20
A2C 150/185 BL-DM	2728780000	A.31
A2C 150/185 BL-DM	2728780000	B.21
A2C 150/185 FE	2728720000	B.20
A2C 150/185 FE	2728720000	B.261
A2C 150/185 FE-DM	2728790000	B.21
A2C 150/185-DM	2728770000	A.31
A2C 150/185-DM	2728770000	B.21
A2C 16	2494000000	A.26
A2C 16 BL	2494100000	A.26
A2C 16 DL	2675000000	A.101
A2C 16 DL BL	2675010000	A.101
A2C 16 PE	2494010000	A.54
A2C 16 PE DL	2675020000	A.102
A2C 2.5	1521850000	A.17
A2C 2.5	1521850000	A.103
A2C 2.5	1521850000	A.105
A2C 2.5	1521850000	A.118
A2C 2.5 /DT/FS	1989900000	A.60
A2C 2.5 /DT/FS	1989900000	A.67
A2C 2.5 /DT/FS	1989900000	A.105
A2C 2.5 /DT/FS BL	1989910000	A.67
A2C 2.5 BK	1521980000	A.118
A2C 2.5 BL	1521880000	A.17
A2C 2.5 BL	1521880000	A.103
A2C 2.5 BL	1521880000	A.118
A2C 2.5 BR	2508030000	A.118
A2C 2.5 DBL	2508000000	A.118
A2C 2.5 DL	2674690000	A.101
A2C 2.5 DL	2674690000	A.103
A2C 2.5 DL BL	2674700000	A.101
A2C 2.5 DL OR	2799150000	A.101
A2C 2.5 FE WT	2690460000	A.47
A2C 2.5 FE WT	2690460000	B.251
A2C 2.5 FE GN	2690460000	B.252
A2C 2.5 GN	1521950000	A.118
A2C 2.5 LTGY	2003110000	A.118
A2C 2.5 OR	1521930000	A.118
A2C 2.5 PE	1521680000	A.47
A2C 2.5 PE	1521680000	A.105
A2C 2.5 PE /DT/FS	1989890000	A.60
A2C 2.5 PE /DT/FS	1989890000	A.67
A2C 2.5 PE DL	2674710000	A.102
A2C 2.5 RD	1521900000	A.118
A2C 2.5 WT	2876640000	A.118
A2C 2.5 YL	1521970000	A.118
A2C 2.5 YL	1521940000	A.118
A2C 35	2551510000	A.28
A2C 35	2551510000	B.8
A2C 35 3FT	2552100000	B.10
A2C 35 3FT DM	2552100000	B.11
A2C 35 3FT-FE	2552100000	B.10
A2C 35 3FT-FE DM	2552180000	B.11
A2C 35 3FT-N	2552130000	B.10
A2C 35 3FT-N DM	2552190000	B.11

Type	Order No.	Page
A2C 35 3FT-N-FE	2552140000	B.10
A2C 35 3FT-N-FE DM	2552200000	B.11
A2C 35 3FT-N-PE	2551540000	B.11
A2C 35 3FT-PE	2552120000	B.11
A2C 35 BL	2552090000	A.28
A2C 35 BL	2552090000	B.8
A2C 35 BL DM	2552150000	A.28
A2C 35 BL DM	2552150000	B.9
A2C 35 DL	2742060000	A.101
A2C 35 DL BL	2756890000	A.101
A2C 35 DM	2551550000	A.28
A2C 35 DM	2551550000	B.9
A2C 35 FE	2551530000	B.8
A2C 35 FE	2551530000	B.259
A2C 35 FE DL	2742070000	A.101
A2C 35 FE DM	2552160000	B.9
A2C 35 FE DM	2552160000	B.259
A2C 35 FE PE	2551520000	A.55
A2C 35 FE PE	2551520000	B.9
A2C 35 FE DL	2735950000	A.102
A2C 4	2051180000	A.19
A2C 4	2051180000	A.105
A2C 4	2051180000	A.118
A2C 4 BK	2051310000	A.118
A2C 4 BL	2051210000	A.19
A2C 4 BL	2051210000	A.118
A2C 4 BR	2534370000	A.118
A2C 4 DBL	2534380000	A.118
A2C 4 DL	2674780000	A.101
A2C 4 DL BL	2674790000	A.101
A2C 4 DL OR	2799170000	A.101
A2C 4 FE WT	2734150000	B.251
A2C 4 FE WT	2734150000	B.253
A2C 4 GN	2051260000	A.118
A2C 4 LTGY	2051330000	A.118
A2C 4 OR	2051230000	A.118
A2C 4 PE	2051360000	A.49
A2C 4 PE	2051360000	A.105
A2C 4 PE DL	2674800000	A.102
A2C 4 RD	2051220000	A.118
A2C 4 WT	2051290000	A.118
A2C 4 YL	2051250000	A.118
A2C 50/70	2663250000	A.29
A2C 50/70	2663250000	B.16
A2C 50/70 3FT	2663320000	B.22
A2C 50/70 3FT-DM	2663390000	B.23
A2C 50/70 3FT-FE	2663310000	B.22
A2C 50/70 3FT-FE-DM	2663380000	B.23
A2C 50/70 3FT-N	2663300000	B.22
A2C 50/70 3FT-N-DM	2663370000	B.23
A2C 50/70 3FT-N-FE	2663290000	B.22
A2C 50/70 3FT-N-FE-DM	2663360000	B.23
A2C 50/70 BL	2663260000	A.29
A2C 50/70 BL	2663260000	B.16
A2C 50/70 BL-DM	2663340000	A.29
A2C 50/70 BL-DM	2663340000	B.17
A2C 50/70 DL	2742090000	A.101
A2C 50/70 DL BL	2756900000	A.101
A2C 50/70 FE	2663270000	B.16
A2C 50/70 FE	2663270000	B.260
A2C 50/70 FE DL	2742100000	A.101
A2C 50/70 FE-DM	2663350000	B.17
A2C 50/70 FE-DM	2663350000	B.260
A2C 50/70 PE	2663280000	A.55
A2C 50/70 PE	2663280000	B.17
A2C 50/70 PE DL	2734110000	A.102
A2C 50/70-DM	2663330000	A.29
A2C 50/70-DM	2663330000	B.17
A2C 6	1992110000	A.22
A2C 6	1992110000	A.105
A2C 6	1992110000	A.118
A2C 6 BL	1991790000	A.22
A2C 6 BL	1991790000	A.118
A2C 6 DL	2674870000	A.101
A2C 6 DL BL	2674880000	A.101
A2C 6 DL OR	2799180000	A.101
A2C 6 FE WT	2734160000	B.251
A2C 6 FE WT	2734160000	B.253
A2C 6 OR	1991800000	A.118
A2C 6 PE	1991810000	A.52
A2C 6 PE	1991810000	A.105
A2C 6 PE DL	2674890000	A.102
A2C 95/120	2694060000	A.29
A2C 95/120	2694060000	B.18
A2C 95/120 3FT	2694140000	B.22
A2C 95/120 3FT-DM	2694230000	B.23
A2C 95/120 3FT-FE	2694130000	B.22
A2C 95/120 3FT-FE-DM	2694220000	B.23
A2C 95/120 3FT-N	2694120000	B.22
A2C 95/120 3FT-N-DM	2694200000	B.23
A2C 95/120 3FT-N-FE	2694100000	B.22
A2C 95/120 3FT-N-FE-DM	2694180000	B.23
A2C 95/120 BL	2694070000	A.29
A2C 95/120 BL	2694070000	B.18
A2C 95/120 BL-DM	2694160000	A.30
A2C 95/120 BL-DM	2694160000	B.19
A2C 95/120 DL	2742120000	A.101
A2C 95/120 DL BL	2756910000	A.101
A2C 95/120 FE	2694080000	B.18

Type	Order No.	Page
A2C 95/120 FE	2694080000	B.261
A2C 95/120 FE DL	2742130000	A.101
A2C 95/120 FE-DM	2694170000	B.19
A2C 95/120 FE-DM	2694170000	B.261
A2C 95/120 PE	2694090000	A.56
A2C 95/120 PE	2694090000	B.19
A2C 95/120 PE DL	2742140000	A.102
A2C 95/120-DM	2694150000	A.30
A2C 95/120-DM	2694150000	B.19
A2T 1.5	2469370000	A.32
A2T 1.5	2469370000	A.105
A2T 1.5 BL	2471430000	A.32
A2T 1.5 DL	2675060000	A.101
A2T 1.5 DL BL	2675070000	A.101
A2T 1.5 FT-PE	2469390000	A.33
A2T 1.5 FT-PE DL	2675080000	A.101
A2T 1.5 KMX RD-BK	2652200000	B.297
A2T 1.5 KMX WT-YL	2652210000	B.297
A2T 1.5 PE	2469410000	A.56
A2T 1.5 PE	2469410000	A.105
A2T 1.5 PE DL	2675100000	A.102
A2T 1.5 VL	2469400000	A.32
A2T 1.5 VL BL	2471450000	A.32
A2T 1.5 VL DL	2675090000	A.101
A2T 2.5	1547610000	A.34
A2T 2.5	1547610000	A.105
A2T 2.5 3C	2531290000	A.36
A2T 2.5 3C BL	2531510000	A.36
A2T 2.5 3C FT-PE	2531300000	A.37
A2T 2.5 3C N-FT	2736830000	A.37
A2T 2.5 3C N-PE	2623550000	A.37
A2T 2.5 3C PE	2531320000	A.58
A2T 2.5 3C VL	2531310000	A.36
A2T 2.5 3C VL BL	2531530000	A.36
A2T 2.5 BL	1547620000	A.34
A2T 2.5 DL	2675110000	A.101
A2T 2.5 DL BL	2675120000	A.101
A2T 2.5 DT/DT	2744110000	A.70
A2T 2.5 DT/DT BL	2744120000	A.70
A2T 2.5 DT/FT	2744130000	A.70
A2T 2.5 DT/FT BL	2744140000	A.70
A2T 2.5 EM1 24VUC LED RD/1	2704410000	A.95
A2T 2.5 EM1 D/0	2704330000	A.92
A2T 2.5 EM1 D/1	2704370000	A.93
A2T 2.5 EM1 D/2	2704380000	A.93
A2T 2.5 EM1 D3/1	2820630000	A.93
A2T 2.5 EM1 D3/2	2820640000	A.93
A2T 2.5 EM2 D/0	2704360000	A.92
A2T 2.5 EM2 D/5	2704390000	A.94
A2T 2.5 EM2 D/6	2704400000	A.94
A2T 2.5 EM3 D/0	2704340000	A.93
A2T 2.5 FT-PE	1547640000	A.35
A2T 2.5 FT-PE DL	2675130000	A.101
A2T 2.5 N-FT	2723370000	A.35
A2T 2.5 PE	1547680000	A.57
A2T 2.5 PE	1547680000	A.105
A2T 2.5 PE DL	2675150000	A.102
A2T 2.5 SNAPMARK	2581250000	A.34
A2T 2.5 SNAPMARK BL	2581280000	A.34
A2T 2.5 VL	1547650000	A.35
A2T 2.5 VL BL	1547660000	A.35
A2T 2.5 VL DL	2675140000	A.101
A2T 2.5 VL DL BL	26751620000	A.101</

Type	Order No.	Page	Type	Order No.	Page	Type	Order No.	Page	Type	Order No.	Page
A3T 2.5 VL	2428540000	A.42	AAC 50-185 2X10	2663420000	A.30	AAP11 6/6X1.5 LQ-LJ BL	2464750000	B.103	ADT 2.5 2C DL BL	2675220000	A.102
A3T 2.5 VL BL	2428850000	A.42	AAC 50-185 2X10	2663420000	A.31	AAP11 6/6X1.5 LQ-LJ BL/OR	2522830000	B.103	ADT 2.5 2C W/D DTLV	1989930000	A.66
A3T 2.5 VL DL	2735510000	A.102	AAC 50-185 2X10	2663420000	B.16	AAP11 6/6X1.5 LQ-LJ DL BL	2675380000	A.102	ADT 2.5 3C	1989830000	A.67
A4C 1.5	1552690000	A.107	AAC 50-185 2X10	2663420000	B.17	AAP11 6/6X1.5 LQ-LJ DL BL/OR	2675410000	A.102	ADT 2.5 3C	1989830000	A.105
A4C 1.5	1552690000	A.105	AAC 50-185 2X10	2663420000	B.18	AAP11 6/6X1.5 LQ-LJ DL OR	2675400000	A.102	ADT 2.5 3C BL	1989840000	A.67
A4C 1.5	1552690000	A.118	AAC 50-185 2X10	2663420000	B.19	AAP11 6/6X1.5 LQ-LJ DL RD	2675390000	A.102	ADT 2.5 3C W/D DTLV	1989940000	A.68
A4C 1.5 BK	2534260000	A.118	AAC 50-185 2X10	2663420000	B.20	AAP11 6/6X1.5 LQ-LJ DR	2503870000	B.103	ADT 2.5 4C	1989860000	A.68
A4C 1.5 BL	1552700000	A.117	AAC 50-185 2X10	2663420000	B.21	AAP11 6/6X1.5 LQ-LJ DR	2464690000	B.103	ADT 2.5 4C	1989860000	A.105
A4C 1.5 BL	1552700000	A.118	AAC 50-185 2X10	2663420000	B.22	AAP11 6/6X1.5 LQ-LJ WT	2712960000	B.103	ADT 2.5 4C BL	1989870000	A.68
A4C 1.5 BR	2534460000	A.118	AAC 50-185 2X10	2663420000	B.23	AAP11 6/6X1.5 PE-LJ	2464740000	B.103	ADT 2.5 4C DL	2675230000	A.102
A4C 1.5 DBL	2534470000	A.118	AAC 50-185 2X10	2663420000	B.24	AAP12 10 FE	1988200000	B.108	ADT 2.5 4C W/D DTLV	1989950000	A.69
A4C 1.5 DL	2674680000	A.101	AAC 50-185 2X10 BK-YL	2663450000	A.29	AAP12 10 LO BL	1988180000	B.108	ADT 4 2C	2429850000	A.69
A4C 1.5 DL BL	2674670000	A.101	AAC 50-185 2X10 BK-YL	2663450000	A.30	AAP12 10 LO BL/OR	2522860000	B.108	ADT 4 2C	2429850000	A.105
A4C 1.5 GN	2534410000	A.118	AAC 50-185 2X10 BK-YL	2663450000	A.31	AAP12 10 LO DL BL	2675440000	A.102	ADT 4 2C BL	2429880000	A.69
A4C 1.5 LTGY	2534420000	A.118	AAC 50-185 2X10 BK-YL	2663450000	B.16	AAP12 10 LO DL BL/OR	2675450000	A.102	ADT 4 2C DL	2675240000	A.102
A4C 1.5 OR	1552720000	A.118	AAC 50-185 2X10 BK-YL	2663450000	B.17	AAP12 10 LO DL OR	2675430000	A.102	AEB 35 SC/1	1991920000	A.6
A4C 1.5 PE	1552660000	A.47	AAC 50-185 2X10 BK-YL	2663450000	B.18	AAP12 10 LO DL RD	2675420000	A.102	AEB 35 SC/1	1991920000	A.7
A4C 1.5 PE	1552680000	A.105	AAC 50-185 2X10 BK-YL	2663450000	B.19	AAP12 10 LO GN/OR	2619410000	B.108	AEB 35 SC/1	1991920000	A.8
A4C 1.5 PE DL	2674680000	A.102	AAC 50-185 2X10 BK-YL	2663450000	B.20	AAP12 10 LO DR	2503900000	B.108	AEB 35 SC/1	1991920000	A.9
A4C 1.5 RD	2534430000	A.118	AAC 50-185 2X10 BK-YL	2663450000	B.21	AAP12 10 LO RD	1988190000	B.108	AEB 35 SC/1	1991920000	A.10
A4C 1.5 WT	2534440000	A.118	AAC 50-185 2X10 BK-YL	2663450000	B.22	AAP12 10 LO WT	2683450000	B.108	AEB 35 SC/1	1991920000	A.11
A4C 1.5 YL	2534450000	A.118	AAC 50-185 2X10 BK-YL	2663450000	B.23	AAP12 10/4X2.5 LQ-LJ BL	2464720000	B.109	AEB 35 SC/1	1991920000	A.12
A4C 2.5	1521690000	A.119	AAC 50-185 2X10 BK-YL	2663450000	B.24	AAP12 10/4X2.5 LQ-LJ BL/OR	2522850000	B.109	AEB 35 SC/1	1991920000	A.16
A4C 2.5	1521690000	A.105	AAC 50-185 2X10 BL	2663430000	A.29	AAP12 10/4X2.5 LQ-LJ DL BL/OR	2675520000	A.102	AEB 35 SC/1	1991920000	A.17
A4C 2.5	1521690000	A.118	AAC 50-185 2X10 BL	2663430000	A.30	AAP12 10/4X2.5 LQ-LJ DL OR	2675510000	A.102	AEB 35 SC/1	1991920000	A.18
A4C 2.5 BK	1521820000	A.118	AAC 50-185 2X10 BL	2663430000	A.31	AAP12 10/4X2.5 LQ-LJ DL RD	2675500000	A.102	AEB 35 SC/1	1991920000	A.19
A4C 2.5 BL	1521700000	A.119	AAC 50-185 2X10 BL	2663430000	B.16	AAP12 10/4X2.5 LQ-LJ DR	2503890000	B.109	AEB 35 SC/1	1991920000	A.20
A4C 2.5 BL	1521700000	A.118	AAC 50-185 2X10 BL	2663430000	B.17	AAP12 10/4X2.5 LQ-LJ DR	2464730000	B.109	AEB 35 SC/1	1991920000	A.21
A4C 2.5 BR	2534750000	A.118	AAC 50-185 2X10 BL	2663430000	B.18	AAP12 10/4X2.5 LQ-LJ WT	2712970000	B.109	AEB 35 SC/1	1991920000	A.22
A4C 2.5 DBL	2534740000	A.118	AAC 50-185 2X10 BL	2663430000	B.19	AAP12 10/4X2.5 PE-LJ	2464710000	B.109	AEB 35 SC/1	1991920000	A.23
A4C 2.5 DL	2674750000	A.101	AAC 50-185 2X10 BL	2663430000	B.20	AAP12 10/4X2.5 PE-LJ BL	2742080000	A.102	AEB 35 SC/1	1991920000	A.24
A4C 2.5 DL BL	2674760000	A.101	AAC 50-185 2X10 BL	2663430000	B.21	AAP12 2.5 LI BL/OR	2522840000	B.109	AEB 35 SC/1	1991920000	A.25
A4C 2.5 DL OR	2799160000	A.101	AAC 50-185 2X10 BL	2663430000	B.22	AAP12 2.5 LI BL	1988100000	B.109	AEB 35 SC/1	1991920000	A.26
A4C 2.5 FE WT	2690470000	B.251	AAC 50-185 2X10 BL	2663430000	B.23	AAP12 2.5 LI DL BL	2675490000	A.102	AEB 35 SC/1	1991920000	A.27
A4C 2.5 FE WT	2690470000	B.252	AAC 50-185 2X10 BL	2663430000	B.24	AAP12 2.5 LI DL BL/OR	2675480000	A.102	AEB 35 SC/1	1991920000	A.28
A4C 2.5 GN	1521770000	A.118	AAC 50-185 2X10 GN-YL	2663440000	A.29	AAP12 2.5 LI DL OR	2675470000	A.102	AEB 35 SC/1	1991920000	A.29
A4C 2.5 LTGY	2003130000	A.118	AAC 50-185 2X10 GN-YL	2663440000	A.30	AAP12 2.5 LI DL RD	2675460000	A.102	AEB 35 SC/1	1991920000	A.30
A4C 2.5 OR	1521720000	A.118	AAC 50-185 2X10 GN-YL	2663440000	A.31	AAP12 2.5 LI GN/OR	2614110000	B.109	AEB 35 SC/1	1991920000	A.32
A4C 2.5 PE	1521540000	A.49	AAC 50-185 2X10 GN-YL	2663440000	A.55	AAP12 2.5 LI OR	2503880000	B.109	AEB 35 SC/1	1991920000	A.33
A4C 2.5 PE	1521540000	A.105	AAC 50-185 2X10 GN-YL	2663440000	A.56	AAP12 2.5 LI RD	1988290000	B.109	AEB 35 SC/1	1991920000	A.34
A4C 2.5 PE DL	2674770000	A.102	AAC 50-185 2X10 GN-YL	2663440000	B.16	AAP12 2.5 LI WT	2683460000	B.109	AEB 35 SC/1	1991920000	A.35
A4C 2.5 RD	1521710000	A.118	AAC 50-185 2X10 GN-YL	2663440000	B.17	AAP12 10/4X2.5 LQ-LJ DL BL	2675530000	A.102	AEB 35 SC/1	1991920000	A.36
A4C 2.5 WT	1521790000	A.118	AAC 50-185 2X10 GN-YL	2663440000	B.18	AAP13 1.5 LHJ	1988280000	B.105	AEB 35 SC/1	1991920000	A.37
A4C 2.5 YL	1521730000	A.118	AAC 50-185 2X10 GN-YL	2663440000	B.19	AAP13 1.5 LHJ DL	2675550000	A.102	AEB 35 SC/1	1991920000	A.38
A4C 4	2051500000	A.21	AAC 50-185 2X10 GN-YL	2663440000	B.20	AAP13 1.5 LHJ DR	2623920000	B.105	AEB 35 SC/1	1991920000	A.39
A4C 4	2051500000	A.105	AAC 50-185 2X10 GN-YL	2663440000	B.21	AAP13 6 FE-LD	1988270000	B.104	AEB 35 SC/1	1991920000	A.40
A4C 4	2051500000	A.118	AAC 50-185 2X10 GN-YL	2663440000	B.22	AAP13 6 LD-LD	1988260000	B.104	AEB 35 SC/1	1991920000	A.41
A4C 4 BK	2051680000	A.118	AAC 50-185 2X10 GN-YL	2663440000	B.23	AAP13 6 LD-LD OR	2675540000	A.102	AEB 35 SC/1	1991920000	A.42
A4C 4 BL	2051520000	A.21	AAC 50-185 2X10 GN-YL	2663440000	B.24	AAP13 6 LD-LD DR	2623910000	B.105	AEB 35 SC/1	1991920000	A.43
A4C 4 BL	2051520000	A.118	AAM 1.5 YE FLASH	2635520000	A.116	AAP14 10 FE-LD	1988240000	B.110	AEB 35 SC/1	1991920000	A.44
A4C 4 BR	2534390000	A.118	AAM 10 YE FLASH	2635580000	A.116	AAP14 10 LD-LD	1988250000	B.110	AEB 35 SC/1	1991920000	A.46
A4C 4 DBL	2534400000	A.118	AAM 16 YE FLASH	2675590000	A.116	AAP14 10 LD-LD DL	2675560000	A.102	AEB 35 SC/1	1991920000	A.47
A4C 4 DL	2674840000	A.101	AAM 2.5 YE FLASH	2635550000	A.116	AAP14 2.5 LHJ	1988230000	B.111	AEB 35 SC/1	1991920000	A.48
A4C 4 DL BL	2674850000	A.101	AAM 35-185 YE FLASH	2635600000	A.28	AAP14 2.5 LHJ DL	2675570000	A.102	AEB 35 SC/1	1991920000	A.49
A4C 4 DL OR	2799180000	A.101	AAM 35-185 YE FLASH	2635600000	A.29	AAP21 10 FE	2428920000	B.114	AEB 35 SC/1	1991920000	A.50
A4C 4 GN	2051580000	A.118	AAM 35-185 YE FLASH	2635600000	A.30	AAP21 10 LO BL	2428940000	B.114	AEB 35 SC/1	1991920000	A.51
A4C 4 LTGY	2051670000	A.118	AAM 35-185 YE FLASH	2635600000	A.31	AAP21 10 LO BL/OR	2581800000	B.115	AEB 35 SC/1	1991920000	A.52
A4C 4 OR	2051540000	A.118	AAM 35-185 YE FLASH	2635600000	A.55	AAP21 10 LO DR	2581690000	B.114	AEB 35 SC/1	1991920000	A.53
A4C 4 PE	2051560000	A.51	AAM 35-185 YE FLASH	2635600000	A.56	AAP21 10 LO RD	2428910000	B.114	AEB 35 SC/1	1991920000	A.54
A4C 4 PE	2051560000	A.105	AAM 35-185 YE FLASH	2635600000	B.8	AAP21 4 DT	2428980000	B.116	AEB 35 SC/1	1991920000	A.55
A4C 4 PE DL	2674860000	A.102	AAM 35-185 YE FLASH	2635600000	B.9	AAP21 4 DT BL/OR	2582520000	B.116	AEB 35 SC/1	1991920000	A.56
A4C 4 RD	2051530000	A.118	AAM 35-185 YE FLASH	2635600000	B.10	AAP21 4 DT OR	2581710000	B.116	AEB 35 SC/1	1991920000	A.57
A4C 4 WT	2051610000	A.118	AAM 35-185 YE FLASH	2635600000	B.11	AAP21 4 FS	2428950000	B.116	AEB 35 SC/1	1991920000	A.58
A4C 4 YL	2051550000	A.118	AAM 35-185 YE FLASH	2635600000	B.12	AAP21 4 FS 10-36V	2458990000	B.116	AEB 35 SC/1	1991920000	A.59
A4C 6	2881450000	A.23	AAM 35-185 YE FLASH	2635600000	B.16	AAP21 4 FS 100-250V	2460180000	B.116	AEB 35 SC/1	1991920000	A.66
A4C 6 BL	2881460000	A.23	AAM 35-185 YE FLASH	2635600000	B.17	AAP21 4 FS 100-250V OR	2581790000	B.116	AEB 35 SC/1	1991920000	A.67
A4C 6 DL	2881500000	A.101	AAM 35-185 YE FLASH	2635600000	B.18	AAP21 4 FS 30-70V	2460200000	B.116	AEB 35 SC/1	1991920000	A.68
A4C 6 DL BL	2881510000	A.101	AAM 35-185 YE FLASH	2635600000	B.19	AAP21 4 FS 60-150V	2460190000	B.116	AEB 35 SC/1	1991920000	A.69
A4C 6 DL FE	2881530000	A.101	AAM 35-185 YE FLASH	2635600000	B.20	AAP21 4 FS OR	2581720000	B.116	AEB 35 SC/1	1991920000	A.70
A4C 6 DL OR	2881520000	A.101	AAM 35-185 YE FLASH	2635600000	B.21	AAP21 4 LI BL	2428960000	B.115	AEB 35 SC/1	1991920000	A.71
A4C 6 FE	2881480000	B.258	AAM 35-185 YE FLASH	2635600000	B.22	AAP21 4 LI BL/OR	2582530000	B.115	AEB 35 SC/1	1991920000	A.72
A4C 6 PE	2881490000	A.53	AAM 35-185 YE FLASH	2635600000	B.23	AAP21 4 LI DR	2581700000	B.115	AEB 35 SC/1	1991920000	A.73
A4C 6 PE DL	2881540000	A.102	AAM 35-185 YE FLASH	2635600000	B.24	AAP21 4 LI RD	2428930000	B.115	AEB 35 SC/1	1991920000	A.74
AAC 35 2X6	2583090000	A.28	AAM 35-185 YE FLASH	2635600000	B.259	AAP22 10 FE-LD	2429000000	B.118	AEB 35 SC/1	1991920000	A.75
AAC 35 2X6	2583090000	B.8	AAM 35-185 YE FLASH	2635600000	B.260	AAP22 10 LD-LD	2428990000	B.118	AEB 35 SC/1	1991920000	A.76
AAC 35 2X6	2583090000	B.9	AAM 35-185 YE FLASH	2635600000	B.261	AAP22 4 LI-FS	2429010000	B.119	AEB 35 SC/1	1991920000	A.77
AAC 35 2X6	2583090000	B.10	AAM 4 YE FLASH	2635560000	A.116	AAP22 4 LI-FS 10-36V	2459010000	B.119	AEB 35 SC/1	1991920000	A.78
AAC 35 2X6	2583090000	B.11	AAM 6 YE FLASH	2635570000	A.11						

Type	Order No.	Page	Type	Order No.	Page	Type	Order No.	Page	Type	Order No.	Page
AEB 35 SC/1	1991920000	B.54	AEB 35 SCL/1 VO	2661280000	A.53	AEB 35 SCL/1 VO GY DL	2570260000	A.102	AEP 2T 4	2540000000	A.82
AEB 35 SC/1	1991920000	B.56	AEB 35 SCL/1 VO	2661280000	A.54	AEB 35 SCL/1 VO GY DL	2570260000	A.117	AEP 2T 4	2540000000	A.83
AEB 35 SC/1	1991920000	B.58	AEB 35 SCL/1 VO	2661280000	A.55	AEB 35 SCL/1 VO TGY DL	2817770000	A.102	AEP 2T 4 BL	2540010000	A.38
AEB 35 SC/1	1991920000	B.59	AEB 35 SCL/1 VO	2661280000	A.56	AEB ITB 16 BB BL	2669130000	B.278	AEP 2T 4 BL	2540010000	A.39
AEB 35 SC/1	1991920000	B.60	AEB 35 SCL/1 VO	2661280000	A.57	AEB ITB 16 BB BL	2669130000	B.279	AEP 2T 4 BL	2540010000	A.82
AEB 35 SC/1	1991920000	B.62	AEB 35 SCL/1 VO	2661280000	A.58	AEB ITB 16 BB BL	2669130000	B.280	AEP 2T 4 BL	2540010000	A.83
AEB 35 SC/1	1991920000	B.64	AEB 35 SCL/1 VO	2661280000	A.59	AEB ITB 16 BB BL	2669130000	B.281	AEP 2T 4 FS	2817060000	A.63
AEB 35 SC/1	1991920000	B.66	AEB 35 SCL/1 VO	2661280000	A.66	AEB ITB 16 BB BL	2669130000	B.282	AEP 2T 4 FS	2817060000	A.64
AEB 35 SC/1	1991920000	B.68	AEB 35 SCL/1 VO	2661280000	A.67	AEB ITB 16 BB BL	2669130000	B.283	AEP 2T 4 FS	2817060000	A.71
AEB 35 SC/1	1991920000	B.69	AEB 35 SCL/1 VO	2661280000	A.68	AEB ITB 16 BB BL	2669130000	B.284	AEP 3C 1.5	1552620000	A.16
AEB 35 SC/1	1991920000	B.72	AEB 35 SCL/1 VO	2661280000	A.69	AEB ITB 16 BB BL	2669130000	B.285	AEP 3C 1.5	1552620000	A.46
AEB 35 SC/1	1991920000	B.73	AEB 35 SCL/1 VO	2661280000	A.70	AEB ITB 16 BB BL	2669130000	B.286	AEP 3C 1.5	1552620000	A.73
AEB 35 SC/1	1991920000	B.76	AEB 35 SCL/1 VO	2661280000	A.71	AEB ITB 16 BB BL	2669130000	B.287	AEP 3C 1.5 BL	1552630000	A.16
AEB 35 SC/1	1991920000	B.78	AEB 35 SCL/1 VO	2661280000	A.72	AEB ITB 16 BB BL	2669130000	B.288	AEP 3C 1.5 BL	1552630000	A.73
AEB 35 SC/1	1991920000	B.80	AEB 35 SCL/1 VO	2661280000	A.73	AEB ITB 16 BB BL	2669130000	B.289	AEP 3C 10/16	2490530000	A.25
AEB 35 SC/1	1991920000	B.82	AEB 35 SCL/1 VO	2661280000	A.74	AEB ITB 16 BB BL	2669130000	B.290	AEP 3C 10/16	2490530000	A.26
AEB 35 SC/1	1991920000	B.84	AEB 35 SCL/1 VO	2661280000	A.75	AEB ITB 16 BB BL	2669130000	B.291	AEP 3C 10/16	2490530000	A.53
AEB 35 SC/1	1991920000	B.86	AEB 35 SCL/1 VO	2661280000	A.76	AEB ITB 16 BB BL	2669130000	B.292	AEP 3C 10/16	2490530000	A.54
AEB 35 SC/1	1991920000	B.94	AEB 35 SCL/1 VO	2661280000	A.77	AEB ITB 16 BB BL	2669130000	B.293	AEP 3C 10/16 BL	2490540000	A.25
AEB 35 SC/1	1991920000	B.102	AEB 35 SCL/1 VO	2661280000	A.78	AEB ITB 2.5/4 BB BL	2690440000	B.278	AEP 3C 10/16 BL	2490540000	A.26
AEB 35 SC/1	1991920000	B.103	AEB 35 SCL/1 VO	2661280000	A.79	AEB ITB 2.5/4 BB BL	2690440000	B.279	AEP 3C 2.5	1521510000	A.18
AEB 35 SC/1	1991920000	B.104	AEB 35 SCL/1 VO	2661280000	A.80	AEB ITB 2.5/4 BB BL	2690440000	B.280	AEP 3C 2.5	1521510000	A.48
AEB 35 SC/1	1991920000	B.105	AEB 35 SCL/1 VO	2661280000	A.81	AEB ITB 2.5/4 BB BL	2690440000	B.281	AEP 3C 2.5	1521510000	A.77
AEB 35 SC/1	1991920000	B.106	AEB 35 SCL/1 VO	2661280000	A.82	AEB ITB 2.5/4 BB BL	2690440000	B.282	AEP 3C 2.5 BL	1521520000	A.18
AEB 35 SC/1	1991920000	B.107	AEB 35 SCL/1 VO	2661280000	A.83	AEB ITB 2.5/4 BB BL	2690440000	B.283	AEP 3C 2.5 BL	1521520000	A.77
AEB 35 SC/1	1991920000	B.108	AEB 35 SCL/1 VO	2661280000	A.92	AEB ITB 2.5/4 BB BL	2690440000	B.284	AEP 3C 4	2051720000	A.20
AEB 35 SC/1	1991920000	B.109	AEB 35 SCL/1 VO	2661280000	A.93	AEB ITB 2.5/4 BB BL	2690440000	B.285	AEP 3C 4	2051720000	A.50
AEB 35 SC/1	1991920000	B.110	AEB 35 SCL/1 VO	2661280000	A.94	AEB ITB 2.5/4 BB BL	2690440000	B.286	AEP 3C 4	2051720000	A.81
AEB 35 SC/1	1991920000	B.111	AEB 35 SCL/1 VO	2661280000	A.95	AEB ITB 2.5/4 BB BL	2690440000	B.287	AEP 3C 4 BK	2486640000	A.61
AEB 35 SC/1	1991920000	B.112	AEB 35 SCL/1 VO	2661280000	A.103	AEB ITB 2.5/4 BB BL	2690440000	B.288	AEP 3C 4 BK	2486640000	A.62
AEB 35 SC/1	1991920000	B.113	AEB 35 SCL/1 VO	2661280000	A.117	AEB ITB 2.5/4 BB BL	2690440000	B.289	AEP 3C 4 BL	2051880000	A.20
AEB 35 SC/1	1991920000	B.114	AEB 35 SCL/1 VO	2661280000	B.8	AEB ITB 2.5/4 BB BL	2690440000	B.290	AEP 3C 4 BL	2051880000	A.81
AEB 35 SC/1	1991920000	B.115	AEB 35 SCL/1 VO	2661280000	B.9	AEB ITB 2.5/4 BB BL	2690440000	B.291	AEP 3C 6	1991940000	A.22
AEB 35 SC/1	1991920000	B.116	AEB 35 SCL/1 VO	2661280000	B.10	AEB ITB 2.5/4 BB BL	2690440000	B.292	AEP 3C 6	1991940000	A.52
AEB 35 SC/1	1991920000	B.118	AEB 35 SCL/1 VO	2661280000	B.11	AEB ITB 2.5/4 BB BL	2690440000	B.293	AEP 3C 6 BL	1991910000	A.22
AEB 35 SC/1	1991920000	B.119	AEB 35 SCL/1 VO	2661280000	B.16	AEP 2C 1.5	1552600000	A.16	AEP 3T 1.5	2816950000	A.40
AEB 35 SC/1	1991920000	B.180	AEB 35 SCL/1 VO	2661280000	B.17	AEP 2C 1.5	1552600000	A.46	AEP 3T 1.5	2816950000	A.41
AEB 35 SC/1	1991920000	B.181	AEB 35 SCL/1 VO	2661280000	B.18	AEP 2C 1.5	1552600000	A.72	AEP 3T 1.5	2816950000	A.59
AEB 35 SC/1	1991920000	B.184	AEB 35 SCL/1 VO	2661280000	B.19	AEP 2C 1.5 BL	1552610000	A.16	AEP 3T 2.5	2428560000	A.34
AEB 35 SC/1	1991920000	B.185	AEB 35 SCL/1 VO	2661280000	B.20	AEP 2C 1.5 BL	1552610000	A.72	AEP 3T 2.5	2428560000	A.42
AEB 35 SC/1	1991920000	B.252	AEB 35 SCL/1 VO	2661280000	B.52	AEP 2C 10/16	2490380000	A.25	AEP 3T 2.5	2428560000	A.43
AEB 35 SC/1	1991920000	B.253	AEB 35 SCL/1 VO	2661280000	B.94	AEP 2C 10/16	2490380000	A.26	AEP 3T 2.5	2428560000	A.59
AEB 35 SC/1	1991920000	B.256	AEB 35 SCL/1 VO	2661280000	B.102	AEP 2C 10/16	2490380000	A.53	AEP 3T 2.5 BL	2428860000	A.34
AEB 35 SC/1	1991920000	B.257	AEB 35 SCL/1 VO	2661280000	B.103	AEP 2C 10/16	2490380000	A.54	AEP 3T 2.5 BL	2428860000	A.42
AEB 35 SC/1	1991920000	B.258	AEB 35 SCL/1 VO	2661280000	B.104	AEP 2C 10/16	2490380000	B.253	AEP 3T 2.5 BL	2428860000	A.43
AEB 35 SC/1	1991920000	B.259	AEB 35 SCL/1 VO	2661280000	B.105	AEP 2C 10/16 BL	2490390000	A.25	AEP 4C 1.5	1552640000	A.17
AEB 35 SC/1	1991920000	B.260	AEB 35 SCL/1 VO	2661280000	B.106	AEP 2C 10/16 BL	2490390000	A.26	AEP 4C 1.5	1552640000	A.47
AEB 35 SC/1	1991920000	B.261	AEB 35 SCL/1 VO	2661280000	B.107	AEP 2C 2.5	1514400000	A.17	AEP 4C 1.5 BL	1552650000	A.17
AEB 35 SC/1	1991920000	B.297	AEB 35 SCL/1 VO	2661280000	B.108	AEP 2C 2.5	1514400000	A.47	AEP 4C 2.5	1521530000	A.19
AEB 35 SC/1	1991920000	C.21	AEB 35 SCL/1 VO	2661280000	B.109	AEP 2C 2.5	1514400000	A.76	AEP 4C 2.5	1521530000	A.49
AEB 35 SC/1 BK	2475310000	B.38	AEB 35 SCL/1 VO	2661280000	B.110	AEP 2C 2.5	1514400000	A.103	AEP 4C 2.5	1521530000	A.66
AEB 35 SC/1 BK	2475310000	B.39	AEB 35 SCL/1 VO	2661280000	B.111	AEP 2C 2.5	1514400000	B.252	AEP 4C 2.5	1521530000	A.67
AEB 35 SC/1 BK	2475310000	B.42	AEB 35 SCL/1 VO	2661280000	B.112	AEP 2C 2.5 BL	1514420000	A.17	AEP 4C 2.5 BK	2486660000	A.60
AEB 35 SC/1 BK	2475310000	B.43	AEB 35 SCL/1 VO	2661280000	B.113	AEP 2C 2.5 BL	1514420000	A.76	AEP 4C 2.5 BL	1521640000	A.19
AEB 35 SC/1 BK	2475310000	B.46	AEB 35 SCL/1 VO	2661280000	B.114	AEP 2C 2.5 BL	1514420000	A.103	AEP 4C 2.5 BL	1521640000	A.66
AEB 35 SC/1 BK	2475310000	B.48	AEB 35 SCL/1 VO	2661280000	B.115	AEP 2C 4	2051680000	A.19	AEP 4C 2.5 BL	1521640000	A.67
AEB 35 SC/1 BK	2475310000	C.21	AEB 35 SCL/1 VO	2661280000	B.116	AEP 2C 4	2051680000	A.49	AEP 4C 4	2051900000	A.21
AEB 35 SCL/1 VO	2661280000	A.6	AEB 35 SCL/1 VO	2661280000	B.118	AEP 2C 4	2051680000	A.80	AEP 4C 4	2051900000	A.51
AEB 35 SCL/1 VO	2661280000	A.7	AEB 35 SCL/1 VO	2661280000	B.119	AEP 2C 4	2051680000	B.253	AEP 4C 4	2051900000	A.69
AEB 35 SCL/1 VO	2661280000	A.8	AEB 35 SCL/1 VO	2661280000	B.134	AEP 2C 4 BL	2051690000	A.19	AEP 4C 4 BL	2051910000	A.21
AEB 35 SCL/1 VO	2661280000	A.9	AEB 35 SCL/1 VO	2661280000	B.136	AEP 2C 4 BL	2051690000	A.80	AEP 4C 4 BL	2051910000	A.69
AEB 35 SCL/1 VO	2661280000	A.10	AEB 35 SCL/1 VO	2661280000	B.138	AEP 2C 6	1991970000	A.22	AEP 4C 6	2876180000	A.23
AEB 35 SCL/1 VO	2661280000	A.11	AEB 35 SCL/1 VO	2661280000	B.142	AEP 2C 6	1991970000	A.52	AEP 4C 6	2876180000	A.53
AEB 35 SCL/1 VO	2661280000	A.12	AEB 35 SCL/1 VO	2661280000	B.184	AEP 2C 6	1991970000	B.253	AEP 4C 6	2876180000	B.258
AEB 35 SCL/1 VO	2661280000	A.16	AEB 35 SCL/1 VO	2661280000	B.185	AEP 2C 6 BL	1991950000	A.22	AEP 4C 6 BL	2876190000	A.23
AEB 35 SCL/1 VO	2661280000	A.17	AEB 35 SCL/1 VO	2661280000	B.252	AEP 2T 1.5	2469420000	A.32	AEP 4C 6 BL	2876190000	B.258
AEB 35 SCL/1 VO	2661280000	A.18	AEB 35 SCL/1 VO	2661280000	B.253	AEP 2T 1.5	2469420000	A.33	AEP AP11	1988320000	B.102
AEB 35 SCL/1 VO	2661280000	A.19	AEB 35 SCL/1 VO	2661280000	B.256	AEP 2T 1.5	2469420000	A.56	AEP AP11	1988320000	B.103
AEB 35 SCL/1 VO	2661280000	A.20	AEB 35 SCL/1 VO	2661280000	B.257	AEP 2T 1.5	2469420000	A.74	AEP AP12	1988300000	B.108
AEB 35 SCL/1 VO	2661280000	A.21	AEB 35 SCL/1 VO	2661280000	B.258	AEP 2T 1.5	2469420000	A.75	AEP AP12	1988300000	B.109
AEB 35 SCL/1 VO	2661280000	A.22	AEB 35 SCL/1 VO	2661280000	B.259	AEP 2T 1.5	2469420000	B.297	AEP AP13	1990140000	B.104
AEB 35 SCL/1 VO	2661280000	A.23	AEB 35 SCL/1 VO	2661280000	B.260	AEP 2T 1.5 BL	2471470000	A.32	AEP AP13	1990140000	B.105
AEB 35 SCL/1 VO	2661280000	A.24	AEB 35 SCL/1 VO	2661280000	B.261	AEP 2T 1.5 BL	2471470000	A.33	AEP AP14	1988340000	B.110
AEB 35 SCL/1 VO	2661280000	A.25	AEB 35 SCL/1 VO	2661280000	B.278	AEP 2T 1.5 BL	2471470000	A.74	AEP AP14	1988340000	B.111
AEB 35 SCL/1 VO	2661280000	A.26	AEB 35 SCL/1 VO	2661280000	B.279	AEP 2T 1.5 BL	2471470000	A.75	AEP AP21	2429020000	B.114
AEB 35 SCL/1 VO	2661280000	A.27	AEB 35 SCL/1 VO	2661280000	B.280	AEP 2T 1.5 BL	2471470000	B.297	AEP AP21	2429020000	B.115
AEB 35 SCL/1 VO	2661280000	A.28	AEB 35 SCL/1 VO	2661280000	B.281	AEP 2T 2.5	1547690000	A.34	AEP AP22	2429020000	B.116
AEB 35 SCL/1 VO	2661280000	A.29	AEB 35 SCL/1 VO	2661280000	B.282	AEP 2T 2.5	1547690000	A.35	AEP AP22	2429040000	B.118
AEB 35 SCL/1 VO	2661280000	A.30	AEB 35 SCL/1 VO	2661280000	B.283	AEP 2T 2.5	1547690000	A.36	AEP AP22	2429040000	B.119
AEB 35 SCL/1 VO	2661280000	A.32	AEB 35 SCL/1 VO	2661280000	B.284	AEP 2T 2.5	1547690000	A.37	AEP DT 2.5 2T	2744150000	A.70
AEB 35 SCL/1 VO	2661280000	A.33	AEB 35 SCL/1 VO	2661280000	B.285	AEP 2T 2.5	1547690000	A.57	AEP DT 2.5 2T BL	2	

Type	Order No.	Page	Type	Order No.	Page	Type	Order No.	Page	Type	Order No.	Page
APG 4/10	2540550000	A.81	APGTB 1.5 FT 2C/1	2482180000	A.72	APP ITB 2.5 BB 2C/NDT BL	2668870000	B.282	ATPG 1.5-10 L	1991890000	B.52
APG 4/10	2540550000	A.82	APGTB 1.5 FT 2C/1	2482180000	A.105	APP ITB 2.5 BB BL	2668970000	B.284	ATPG 1.5-10 L	1991890000	B.102
APG 4/10	2540550000	A.83	APGTB 1.5 FT 2C/1 BL	2482170000	A.72	APP ITB 2.5 BB BL	2668970000	B.285	ATPG 1.5-10 L	1991890000	B.103
APG 4/10	2540550000	A.85	APGTB 1.5 FT 2C/1 DL	2675680000	A.102	APP ITB 2.5 BB BL	2668970000	B.286	ATPG 1.5-10 L	1991890000	B.104
APG 4/2	2540470000	A.85	APGTB 1.5 FT 2C/1 DL BL	2675690000	A.102	APP ITB 2.5 BB BL	2668970000	B.287	ATPG 1.5-10 L	1991890000	B.105
APG 4/3	2540480000	A.85	APGTB 1.5 FT 3C/1	2482180000	A.73	APP ITB 2.5 BB BL VI	2881640000	B.284	ATPG 1.5-10 L	1991890000	B.108
APG 4/3-BG-BL-GN	2540450000	A.85	APGTB 1.5 FT 3C/1	2482180000	A.105	APP ITB 2.5 BB BL VI	2881640000	B.285	ATPG 1.5-10 L	1991890000	B.109
APG 4/4	2540490000	A.85	APGTB 1.5 FT 3C/1 BL	2482190000	A.73	APP ITB 2.5 BB BL VI	2881640000	B.286	ATPG 1.5-10 L	1991890000	B.110
APG 4/4-3BG-GN	2540440000	A.85	APGTB 1.5 FT 3C/1 DL	2675710000	A.102	APP ITB 2.5 BB BL VI	2881640000	B.287	ATPG 1.5-10 L	1991890000	B.114
APG 4/5	2540500000	A.85	APGTB 1.5 FT 3C/1 DL BL	2675720000	A.102	APP ITB 4 BB BL	2669120000	B.288	ATPG 1.5-10 L	1991890000	B.115
APG 4/5-3BG-BL-GN	2540430000	A.85	APGTB 1.5 FT 4C/2	2482200000	A.73	APP ITB 4 BB BL	2669120000	B.289	ATPG 1.5-10 L	1991890000	B.184
APG 4/6	2540510000	A.85	APGTB 1.5 FT 4C/2	2482200000	A.105	APP ITB 4 BB BL VI	2881650000	B.288	ATPG 1.5-10 L	1991890000	B.185
APG 4/7	2540520000	A.85	APGTB 1.5 FT 4C/2 BL	2482210000	A.73	APP ITB 4 BB BL VI	2881650000	B.289	ATPG 1.5-10 L	1991890000	B.252
APG 4/8	2540530000	A.85	APGTB 1.5 FT 4C/2 DL	2675740000	A.102	APP ITB 6 BB 2C/NDT BL	2668880000	B.278	ATPG 1.5-10 L	1991890000	B.253
APG 4/9	2540540000	A.85	APGTB 1.5 FT 4C/2 DL BL	2675750000	A.102	APP ITB 6 BB 2C/NDT BL	2668880000	B.280	ATPG 1.5-10 L	1991890000	B.256
APG 6/1	2762320000	B.142	APGTB 1.5 PE 2C/1	2482220000	A.72	APP ITB 6 BB 2C/NDT BL	2668880000	B.282	ATPG 1.5-10 L	1991890000	B.257
APG 6/1	2762320000	B.143	APGTB 1.5 PE 2C/1	2482220000	A.105	ASP 2T 2.5	2820650000	A.95	ATPG 1.5-10 L	1991890000	B.258
APG 6/1	2762320000	B.146	APGTB 1.5 PE 2C/1 DL	2675700000	A.102	ATPG 1.5 MI-R	1991880000	A.16	ATPG 1.5-10 L	1991890000	B.259
APG 6/2	2882750000	B.143	APGTB 1.5 PE 3C/1	2482230000	A.73	ATPG 1.5 MI-R	1991880000	A.17	ATPG 1.5-10 L	1991890000	B.260
APG 6/2 MBB	2762330000	B.142	APGTB 1.5 PE 3C/1	2482230000	A.105	ATPG 1.5 MI-R	1991880000	A.32	ATPG 1.5-10 L	1991890000	B.261
APG 6/2 MBB	2762330000	B.143	APGTB 1.5 PE 3C/1 DL	2675730000	A.102	ATPG 1.5 MI-R	1991880000	A.33	ATPG 1.5-10 L	1991890000	B.278
APG 6/2 MBB	2762330000	B.146	APGTB 1.5 PE 4C/2	2482240000	A.74	ATPG 1.5 MI-R	1991880000	A.40	ATPG 1.5-10 L	1991890000	B.279
APG 6/3	2882690000	B.143	APGTB 1.5 PE 4C/2	2482240000	A.105	ATPG 1.5 MI-R	1991880000	A.41	ATPG 1.5-10 L	1991890000	B.280
APG 6/3 MBB	2762340000	B.142	APGTB 1.5 PE 4C/2 DL	2675760000	A.102	ATPG 1.5 MI-R	1991880000	A.46	ATPG 1.5-10 L	1991890000	B.281
APG 6/3 MBB	2762340000	B.143	APGTB 2.5 2T 4C/2	1548060000	A.78	ATPG 1.5 MI-R	1991880000	A.47	ATPG 1.5-10 L	1991890000	B.282
APG 6/3 MBB	2762340000	B.146	APGTB 2.5 2T 4C/2	1548060000	A.105	ATPG 1.5 MI-R	1991880000	A.56	ATPG 1.5-10 L	1991890000	B.283
APG 6/4	2829060000	B.143	APGTB 2.5 2T 4C/2 BL	1548070000	A.78	ATPG 1.5 MI-R	1991880000	A.59	ATPG 1.5-10 L	1991890000	B.284
APGCE	1514490000	A.84	APGTB 2.5 2T 4C/2 DL	2675910000	A.102	ATPG 1.5 MI-R	1991880000	A.115	ATPG 1.5-10 L	1991890000	B.285
APGCE	1514490000	A.85	APGTB 2.5 2T 4C/2 DL BL	2675920000	A.102	ATPG 1.5 MI-R	1991880000	B.184	ATPG 1.5-10 L	1991890000	B.286
APGCE	1514490000	A.86	APGTB 2.5 2T FT-PE 4C/2	1548130000	A.79	ATPG 1.5 MI-R	1991880000	B.185	ATPG 1.5-10 L	1991890000	B.287
APGCE	1514490000	A.89	APGTB 2.5 2T FT-PE 4C/2 DL	2675930000	A.102	ATPG 1.5 MI-R	1991880000	B.297	ATPG 1.5-10 L	1991890000	B.288
APGCE	1514490000	A.320	APGTB 2.5 2T PE 4C/2	1548160000	A.79	ATPG 1.5-10 L	1991890000	A.6	ATPG 1.5-10 L	1991890000	B.289
APGCE	1514490000	A.321	APGTB 2.5 2T PE 4C/2	1548160000	A.105	ATPG 1.5-10 L	1991890000	A.7	ATPG 1.5-10 L	1991890000	B.290
APGCE	1514490000	A.324	APGTB 2.5 2T PE 4C/2 DL	2675940000	A.102	ATPG 1.5-10 L	1991890000	A.8	ATPG 1.5-10 L	1991890000	B.291
APGCE	1514490000	B.142	APGTB 2.5 2T VL 4C/2	1548140000	A.79	ATPG 1.5-10 L	1991890000	A.9	ATPG 1.5-10 L	1991890000	B.292
APGCE	1514490000	B.147	APGTB 2.5 2T VL 4C/2 BL	1548150000	A.79	ATPG 1.5-10 L	1991890000	A.10	ATPG 1.5-10 L	1991890000	B.293
APGLE 1.5	2482720000	A.84	APGTB 2.5 2T VL 4C/2 DL	2675950000	A.102	ATPG 1.5-10 L	1991890000	A.11	ATPG 1.5-10 L	1991890000	B.297
APGLE 1.5	2482720000	A.86	APGTB 2.5 FT 2C/1	1513970000	A.76	ATPG 1.5-10 L	1991890000	A.12	ATPG 10 MI-R	1991870000	A.25
APGLE 1.5	2482720000	A.89	APGTB 2.5 FT 2C/1	1513970000	A.105	ATPG 1.5-10 L	1991890000	A.16	ATPG 10 MI-R	1991870000	A.115
APGLE 2.5/4	2457570000	A.84	APGTB 2.5 FT 2C/1 BL	1513990000	A.76	ATPG 1.5-10 L	1991890000	A.17	ATPG 2.5 MI-R	1991960000	A.6
APGLE 2.5/4	2457570000	A.85	APGTB 2.5 FT 2C/1 DL	2675820000	A.102	ATPG 1.5-10 L	1991890000	A.18	ATPG 2.5 MI-R	1991960000	A.7
APGLE 2.5/4	2457570000	A.86	APGTB 2.5 FT 2C/1 DL BL	2675830000	A.102	ATPG 1.5-10 L	1991890000	A.19	ATPG 2.5 MI-R	1991960000	A.8
APGLE 2.5/4	2457570000	A.89	APGTB 2.5 FT 3C/1	1514000000	A.77	ATPG 1.5-10 L	1991890000	A.20	ATPG 2.5 MI-R	1991960000	A.9
APGLE 2.5/4	2457570000	A.320	APGTB 2.5 FT 3C/1	1514000000	A.105	ATPG 1.5-10 L	1991890000	A.21	ATPG 2.5 MI-R	1991960000	A.10
APGLE 2.5/4	2457570000	A.321	APGTB 2.5 FT 3C/1 BL	1514020000	A.77	ATPG 1.5-10 L	1991890000	A.22	ATPG 2.5 MI-R	1991960000	A.11
APGLE 2.5/4	2457570000	A.324	APGTB 2.5 FT 3C/1 DL	2675850000	A.102	ATPG 1.5-10 L	1991890000	A.23	ATPG 2.5 MI-R	1991960000	A.12
APGLE 6	2762400000	B.142	APGTB 2.5 FT 3C/1 DL BL	2675860000	A.102	ATPG 1.5-10 L	1991890000	A.24	ATPG 2.5 MI-R	1991960000	A.17
APGLE 6	2762400000	B.147	APGTB 2.5 FT 4C/2	1514030000	A.77	ATPG 1.5-10 L	1991890000	A.26	ATPG 2.5 MI-R	1991960000	A.18
APGPC 1.5	2482530000	A.84	APGTB 2.5 FT 4C/2	1514030000	A.105	ATPG 1.5-10 L	1991890000	A.27	ATPG 2.5 MI-R	1991960000	A.19
APGPC 1.5	2482530000	A.86	APGTB 2.5 FT 4C/2 BL	1514040000	A.77	ATPG 1.5-10 L	1991890000	A.28	ATPG 2.5 MI-R	1991960000	A.34
APGPC 1.5	2482530000	A.89	APGTB 2.5 FT 4C/2 DL	2675880000	A.102	ATPG 1.5-10 L	1991890000	A.29	ATPG 2.5 MI-R	1991960000	A.35
APGPC 2.5	1514500000	A.84	APGTB 2.5 FT 4C/2 DL BL	2675890000	A.102	ATPG 1.5-10 L	1991890000	A.30	ATPG 2.5 MI-R	1991960000	A.36
APGPC 2.5	1514500000	A.86	APGTB 2.5 PE 2C/1	1513870000	A.76	ATPG 1.5-10 L	1991890000	A.31	ATPG 2.5 MI-R	1991960000	A.37
APGPC 2.5	1514500000	A.89	APGTB 2.5 PE 2C/1	1513870000	A.105	ATPG 1.5-10 L	1991890000	A.32	ATPG 2.5 MI-R	1991960000	A.42
APGPC 4	2540960000	A.85	APGTB 2.5 PE 2C/1 DL	2675840000	A.102	ATPG 1.5-10 L	1991890000	A.33	ATPG 2.5 MI-R	1991960000	A.43
APGPC 4	2540960000	A.89	APGTB 2.5 PE 3C/1	1513890000	A.77	ATPG 1.5-10 L	1991890000	A.34	ATPG 2.5 MI-R	1991960000	A.47
APGPC 6	2762410000	B.142	APGTB 2.5 PE 3C/1	1513890000	A.105	ATPG 1.5-10 L	1991890000	A.35	ATPG 2.5 MI-R	1991960000	A.48
APGPC 6	2762410000	B.146	APGTB 2.5 PE 3C/1 DL	2675870000	A.102	ATPG 1.5-10 L	1991890000	A.36	ATPG 2.5 MI-R	1991960000	A.49
APGSR 1.5	2482730000	A.84	APGTB 2.5 PE 4C/2	1513920000	A.78	ATPG 1.5-10 L	1991890000	A.37	ATPG 2.5 MI-R	1991960000	A.50
APGSR 1.5	2482730000	A.86	APGTB 2.5 PE 4C/2	1513920000	A.105	ATPG 1.5-10 L	1991890000	A.38	ATPG 2.5 MI-R	1991960000	A.51
APGSR 1.5	2482730000	A.88	APGTB 2.5 PE 4C/2 DL	2675900000	A.102	ATPG 1.5-10 L	1991890000	A.39	ATPG 2.5 MI-R	1991960000	A.57
APGSR 1.5-4P	2482740000	A.84	APGTB 4 2T 4C/2	2540230000	A.82	ATPG 1.5-10 L	1991890000	A.40	ATPG 2.5 MI-R	1991960000	A.58
APGSR 1.5-4P	2482740000	A.86	APGTB 4 2T 4C/2 BL	2540250000	A.82	ATPG 1.5-10 L	1991890000	A.41	ATPG 2.5 MI-R	1991960000	A.59
APGSR 1.5-4P	2482740000	A.88	APGTB 4 2T 4C/2 DL	2676050000	A.102	ATPG 1.5-10 L	1991890000	A.42	ATPG 2.5 MI-R	1991960000	A.66
APGSR 1.5-8P	2482750000	A.84	APGTB 4 2T 4C/2 DL BL	2676060000	A.102	ATPG 1.5-10 L	1991890000	A.43	ATPG 2.5 MI-R	1991960000	A.67
APGSR 1.5-8P	2482750000	A.86	APGTB 4 2T FT-PE 4C/2	2540290000	A.83	ATPG 1.5-10 L	1991890000	A.46	ATPG 2.5 MI-R	1991960000	A.68
APGSR 1.5-8P	2482750000	A.88	APGTB 4 2T FT-PE 4C/2 DL	2676070000	A.102	ATPG 1.5-10 L	1991890000	A.47	ATPG 2.5 MI-R	1991960000	A.69
APGSR 2.5/4	2457580000	A.84	APGTB 4 2T PE 4C/2	2540300000	A.83	ATPG 1.5-10 L	1991890000	A.48	ATPG 2.5 MI-R	1991960000	A.70
APGSR 2.5/4	2457580000	A.85	APGTB 4 2T PE 4C/2 DL	2676080000	A.102	ATPG 1.5-10 L	1991890000	A.49	ATPG 2.5 MI-R	1991960000	A.103
APGSR 2.5/4	2457580000	A.86	APGTB 4 2T VL 4C/2	2540260000	A.83	ATPG 1.5-10 L	1991890000	A.50	ATPG 2.5 MI-R	1991960000	A.115
APGSR 2.5/4	2457580000	A.88	APGTB 4 2T VL 4C/2 BL	2540270000	A.83	ATPG 1.5-10 L	1991890000	A.51	ATPG 2.5 MI-R	1991960000	B.252
APGSR 2.5/4	2457580000	A.320	APGTB 4 2T VL 4C/2 DL	2676090000	A.102	ATPG 1.5-10 L	1991890000	A.52	ATPG 2.5 MI-R	1991960000	B.256
APGSR 2.5/4	2457580000	A.321	APGTB 4 FT 2C/1	2540050000	A.80	ATPG 1.5-10 L	1991890000	A.53	ATPG 2.5 MI-R	1991960000	B.257
APGSR 2.5/4	2457580000	A.325	APGTB 4 FT 2C/1 BL	2540060000	A.80	ATPG 1.5-10 L	1991890000	A.54	ATPG 2.5 MI-R	1991960000	B.278
APGSR 2.5/4-4P	2457590000	A.84	APGTB 4 FT 2C/1 DL	2675960000	A.102	ATPG 1.5-10 L	1991890000	A.55	ATPG 2.5 MI-R	1991960000	B.280
APGSR 2.5/4-4P	2457590000	A.85	APGTB 4 FT 2C/1 DL BL	2675970000	A.102	ATPG 1.5-10 L	1991890000	A.56	ATPG 2.5 MI-R	1991960000	B.282
APGSR 2.5/4-4P	2457590000	A.86	APGTB 4 FT 3C/1	2540070000	A.81	ATPG 1.5-10 L	1991890000	A.57	ATPG 2.5 MI-R	1991960000	B.284
APGSR 2.5/4-4P	2457590000										

Type	Order No.	Page
DEK 5/8 MC NE WS	1856740000	B.278
DEK 5/8 MC NE WS	1856740000	B.280
DEK 5/8 MC NE WS	1856740000	B.282
DEK 5/8 MM WS	2007130000	A.133
DEK 5/8 MM WS	2007130000	A.141
DEK 5/8 MM WS	2007130000	A.165
DEK 5/8 MM WS	2007130000	A.170
DEK 5/8 MM WS	2007130000	A.171
DEK 5/8 MM WS	2007130000	A.219
DEK 5/8 MM WS	2007130000	A.248
DEK 5/8 MM WS	2007130000	A.249
DEK 5/8 MM WS	2007130000	A.289
DEK 5/8 MM WS	2007130000	A.290
DEK 5/8 MM WS	2007130000	A.293
DEK 5/8 PLUS MC NE WS	1046350000	A.22
DEK 5/8 PLUS MC NE WS	1046350000	A.23
DEK 5/8 PLUS MC NE WS	1046350000	A.24
DEK 5/8 PLUS MC NE WS	1046350000	A.25
DEK 5/8 PLUS MC NE WS	1046350000	A.26
DEK 5/8 PLUS MC NE WS	1046350000	A.27
DEK 5/8 PLUS MC NE WS	1046350000	A.52
DEK 5/8 PLUS MC NE WS	1046350000	A.53
DEK 5/8 PLUS MC NE WS	1046350000	A.54
DEK 5/8 PLUS MC NE WS	1046350000	B.102
DEK 5/8 PLUS MC NE WS	1046350000	B.103
DEK 5/8 PLUS MC NE WS	1046350000	B.104
DEK 5/8 PLUS MC NE WS	1046350000	B.105
DEK 5/8 PLUS MC NE WS	1046350000	B.106
DEK 5/8 PLUS MC NE WS	1046350000	B.107
DEK 5/8 PLUS MC NE WS	1046350000	B.108
DEK 5/8 PLUS MC NE WS	1046350000	B.109
DEK 5/8 PLUS MC NE WS	1046350000	B.110
DEK 5/8 PLUS MC NE WS	1046350000	B.112
DEK 5/8 PLUS MC NE WS	1046350000	B.113
DEK 5/8 PLUS MC NE WS	1046350000	B.114
DEK 5/8 PLUS MC NE WS	1046350000	B.115
DEK 5/8 PLUS MC NE WS	1046350000	B.118
DEK 5/8 PLUS MC NE WS	1046350000	B.134
DEK 5/8 PLUS MC NE WS	1046350000	B.135
DEK 5/8 PLUS MC NE WS	1046350000	B.136
DEK 5/8 PLUS MC NE WS	1046350000	B.137
DEK 5/8 PLUS MC NE WS	1046350000	B.138
DEK 5/8 PLUS MC NE WS	1046350000	B.139
DEK 5/8 PLUS MC NE WS	1046350000	B.143
DEK 5/8 PLUS MC NE WS	1046350000	B.142
DEK 5/8 PLUS MC NE WS	1046350000	B.143
DEK 5/8 PLUS MC NE WS	1046350000	B.144
DEK 5/8 PLUS MC NE WS	1046350000	B.160
DEK 5/8 PLUS MC NE WS	1046350000	B.161
DEK 5/8 PLUS MC NE WS	1046350000	B.253
DEK 5/8 PLUS MC NE WS	1046350000	B.258
DEK 5/8 PLUS MC WS LRP	2770670000	B.143
DEK-A 5/8 MM WS	2448860000	A.22
DEK-A 5/8 MM WS	2448860000	A.23
DEK-A 5/8 MM WS	2448860000	A.24
DEK-A 5/8 MM WS	2448860000	A.52
DEK-A 5/8 MM WS	2448860000	A.53
DEK-A 5/8 MM WS	2448860000	B.102
DEK-A 5/8 MM WS	2448860000	B.103
DEK-A 5/8 MM WS	2448860000	B.104
DEK-A 5/8 MM WS	2448860000	B.105
DEK-A 5/8 MM WS	2448860000	B.106
DEK-A 5/8 MM WS	2448860000	B.135
DEK-A 5/8 MM WS	2448860000	B.137
DEK-A 5/8 MM WS	2448860000	B.139
DEK-A 5/8 MM WS	2448860000	B.253
DEK-A 5/8 MM WS	2448860000	B.258
DEK-A 5/8 MM WS	2448860000	B.339
DEK-A 5/8 MM WS	2448860000	B.523
DEK-A 5/8 MM WS	2448860000	B.528
DFFC 5-1.0 ZRV1.5	1705320000	A.206
DFFC 0.2.0.35 ZRV1.5	1705310000	A.206
DKSUE NSCH/ESCH	0280100000	C.12
DLA 2.5 DB	1783560000	B.192
DLA 2.5/0 DB	1783590000	B.192
DLA 2.5/LD-RT	1783600000	B.193
DLA 2.5 DB	1784180000	B.190
DLA 2.5/PE DB	1783790000	B.190
DUI 2.5 DB	1783820000	B.191
DUI 2.5/LD-GN/PNP + DB	1783940000	B.191
DUI 2.5/LD-GN/PNP - DB	1783970000	B.191
DUI 2.5/LD-RT/PNP + DB	1783950000	B.191
DUI 2.5/LD-RT/PNP - DB	1783980000	B.191

E

E 14/10A RT	0328400000	A.297
E 14/10A RT	0328400000	A.304
E 14/16A GR	0328500000	A.304
E 14/2A RS	0137400000	A.297
E 14/2A RS	0137400000	A.304
E 14/4A BR	0137500000	A.297
E 14/4A BR	0137500000	A.304
E 14/6A GN	0328300000	A.297
E 14/6A GN	0328300000	A.304
E 16/10A RT TNDZ	0208500000	A.297
E 16/10A RT TNDZ	0208500000	A.304
E 16/16A GR TNDZ	0208600000	A.297
E 16/16A GR TNDZ	0208600000	A.304
E 16/20A BL TNDZ	0208700000	A.297
E 16/20A BL TNDZ	0208700000	A.304
E 16/25A GE TNDZ	0208800000	A.297
E 16/25A GE TNDZ	0208800000	A.304
E 18/20A BL	0361300000	A.298
E 18/20A BL	0361300000	A.305

Type	Order No.	Page
E 18/25A GE	0361400000	A.298
E 18/25A GE	0361400000	A.305
E 18/35A SW	0361500000	A.298
E 18/35A SW	0361500000	A.305
E 18/50A WS	0361600000	A.305
E 18/63A KU	0361700000	A.305
EBB 25-50/16	1547490000	B.250
EBB 25-50/16 AM	2756940000	B.250
END CAP G+S 1L/10-16	2658970000	C.25
END CAP G+S 1L/10-16	2658970000	C.26
END CAP G+S 2L/10	2658980000	C.27
END CAP G+S 2L/10	2658980000	C.28
END CAP G+S 2L/16	2658990000	C.27
END CAP G+S 2L/16	2658990000	C.28
END CAP G+S 3L/10	2659000000	C.29
END CAP G+S 3L/10	2659000000	C.30
END CAP G+S 3L/16	2659010000	C.29
END CAP G+S 3L/16	2659010000	C.30
END CAP G+S 4L/10	2659010000	C.31
END CAP G+S 4L/10	2659010000	C.32
END CAP G+S 4L/16	2659030000	C.31
END CAP G+S 4L/16	2659030000	C.32
EP TTB 6	2710170000	B.134
EP TTB 6	2710170000	B.135
EP TTB 6	2710170000	B.136
EP TTB 6	2710170000	B.137
EP TTB 6	2710170000	B.138
EP TTB 6	2710170000	B.139
ESCH 1 M	0280300000	C.12
ESG 6/15 K MC NE WS	1801100000	A.295
ESD 7 DIN A4 WS	1607720000	A.201
ESD 7 DIN A4 WS	1607720000	A.209
ETA 1170 21 10A	1278790000	A.189
ETA 1170 21 20A	1278820000	A.189
ETA 1170 21 25A	1278830000	A.189
ETA 1170 21 3A	1278730000	A.189
ETA 1170 21 4A	1278740000	A.189
ETA 1170 21 5A	1278750000	A.189
ETA 1170 21 6A	1278760000	A.189
ETA 1170 21 7.5A	1278770000	A.189
ETA 1170 21 8A	1278780000	A.189
ETA 1180 01 0.1A	1278840000	A.188
ETA 1180 01 0.1A	1278840000	A.190
ETA 1180 01 0.25A	1278860000	A.188
ETA 1180 01 0.25A	1278860000	A.190
ETA 1180 01 0.2A	1278850000	A.188
ETA 1180 01 0.2A	1278850000	A.190
ETA 1180 01 0.3A	1278870000	A.188
ETA 1180 01 0.3A	1278870000	A.190
ETA 1180 01 0.4A	1278880000	A.188
ETA 1180 01 0.4A	1278880000	A.190
ETA 1180 01 0.5A	1278910000	A.188
ETA 1180 01 0.5A	1278910000	A.190
ETA 1180 01 0.6A	1278920000	A.188
ETA 1180 01 0.6A	1278920000	A.190
ETA 1180 01 0.7A	1278930000	A.188
ETA 1180 01 0.7A	1278930000	A.190
ETA 1180 01 0.8A	1278940000	A.188
ETA 1180 01 0.8A	1278940000	A.190
ETA 1180 01 1.5A	1278960000	A.188
ETA 1180 01 1.5A	1278960000	A.190
ETA 1180 01 10A	1279070000	A.188
ETA 1180 01 10A	1279070000	A.190
ETA 1180 01 1A	1278950000	A.188
ETA 1180 01 1A	1278950000	A.190
ETA 1180 01 2.5A	1278980000	A.188
ETA 1180 01 2.5A	1278980000	A.190
ETA 1180 01 2A	1278970000	A.188
ETA 1180 01 2A	1278970000	A.190
ETA 1180 01 3.5A	1279010000	A.188
ETA 1180 01 3.5A	1279010000	A.190
ETA 1180 01 3A	1278990000	A.188
ETA 1180 01 3A	1278990000	A.190
ETA 1180 01 4A	1279020000	A.188
ETA 1180 01 4A	1279020000	A.190
ETA 1180 01 5A	1279030000	A.188
ETA 1180 01 5A	1279030000	A.190
ETA 1180 01 6A	1279040000	A.188
ETA 1180 01 6A	1279040000	A.190
ETA 1180 01 7A	1279050000	A.188
ETA 1180 01 7A	1279050000	A.190
ETA 1180 01 8A	1279060000	A.188
ETA 1180 01 8A	1279060000	A.190
EW 15	0382860000	A.240
EW 15	0382860000	A.242
EW 15	0382860000	A.244
EW 15	0382860000	A.262
EW 15	0382860000	A.272
EW 15	0382860000	A.273
EW 15	0382860000	A.274
EW 15	0382860000	C.21
EW 15/2	1071900000	C.21
EW 35	0383560000	A.243
EW 35	0383560000	B.190
EW 35	0383560000	B.191
EW 35	0383560000	B.192
EW 35	0383560000	B.193
EW 35	0383560000	C.21
EW 35 DB	1269050000	C.21

Type	Order No.	Page
EW 35 GR 7032	0383530000	C.21
EWK 1	0206160000	B.156
EWK 1	0206160000	B.166
EWK 1	0206160000	B.176
EWK 1	0206160000	C.21
EWK 2	0199360000	C.21

Type	Order No.	Page
FB 16-50	2623930000	B.250
FEKO ET ZRV2.5 0.5-1	1893970000	A.207
FEKO ET ZRV2.5 1.5-2.5	1893990000	A.207
FEKO ZRV2.5 0.2-0.35	1854750000	A.207
FEKO ZRV2.5 0.5-1	1854760000	A.207
FEKO ZRV2.5 1.5-2.5	1848480000	A.207
FIT 25 GN	2659050000	C.33
FIT 25 SN	2659060000	C.33
FIT 50 GN	2659070000	C.33
FIT 50 GN/F	2659090000	C.33
FIT 50 SN	2659080000	C.33
FIT 50 SN/F	2659100000	C.33
FKSC M5X8 D9/SW2.5	0295900000	C.22
FKSC M6X12 D9/SW3	0353500000	C.22
FKSC M6X8 D9/SW3	0642600000	C.22
FM 4.2/TS35	1724580000	C.22
FM 4/TS35	0687900000	C.22
FM 5/TS35	0636800000	C.22
FM 6/TS35	0636900000	C.22
FUCR 10-36V SW	1167640000	B.220
FUCR 10-36V SW	1167640000	B.221
FUCR 10-36V SW	1167640000	B.222
FUCR 10-36V SW	1167640000	B.223
FUCR 10-36V SW	1167640000	B.224
FUCR 10-36V SW	1167640000	B.225
FUCR 10-36V SW	1167640000	B.228
FUCR 100-250V SW	1167680000	B.220
FUCR 100-250V SW	1167680000	B.221
FUCR 100-250V SW	1167680000	B.222
FUCR 100-250V SW	1167680000	B.223
FUCR 100-250V SW	1167680000	B.224
FUCR 100-250V SW	1167680000	B.225
FUCR SW	1167630000	B.220
FUCR SW	1167630000	B.221
FUCR SW	1167630000	B.222
FUCR SW	1167630000	B.223
FUCR SW	1167630000	B.224
FUCR SW	1167630000	B.225

Type	Order No.	Page
G 20/0.10A/F	0430300000	A.191
G 20/0.10A/F	0430300000	A.304
G 20/0.20A/F	0430400000	A.191
G 20/0.20A/F	0430400000	A.304
G 20/0.25A/F	0430500000	A.61
G 20/0.25A/F	0430500000	A.62
G 20/0.25A/F	0430500000	A.63
G 20/0.25A/F	0430500000	A.64
G 20/0.25A/F	0430500000	A.177
G 20/0.25A/F	0430500000	A.178
G 20/0.25A/F	0430500000	A.179
G 20/0.25A/F	0430500000	A.182
G 20/0.25A/F	0430500000	A.184
G 20/0.25A/F	0430500000	A.186
G 20/0.25A/F	0430500000	A.187
G 20/0.25A/F	0430500000	A.191
G 20/0.25A/F	0430500000	A.284
G 20/0.25A/F	0430500000	A.285
G 20/0.25A/F	0430500000	A.286
G 20/0.25A/F	0430500000	A.287
G 20/0.25A/F	0430500000	A.289
G 20/0.25A/F	0430500000	A.290
G 20/0.25A/F	0430500000	A.293
G 20/0.25A/F	0430500000	A.299
G 20/0.25A/F	0430500000	A.300
G 20/0.25A/F	0430500000	A.301
G 20/0.25A/F	0430500000	A.302
G 20/0.25A/F	0430500000	A.304
G 20/0.25A/F	0430500000	B.116
G 20/0.25A/F	0430	

Type	Order No.	Page
G 25/0.50A/M WS	0510300000	A.182
G 25/0.50A/M WS	0510300000	A.187
G 25/0.50A/M WS	0510300000	A.191
G 25/0.50A/M WS	0510300000	A.304
G 25/0.80A/M GR	0646400000	A.191
G 25/0.80A/M GR	0646400000	A.304
G 25/1.00A/M RT	0265800000	A.179
G 25/1.00A/M RT	0265800000	A.182
G 25/1.00A/M RT	0265800000	A.187
G 25/1.00A/M RT	0265800000	A.191
G 25/1.00A/M RT	0265800000	A.304
G 25/10.0A/M RT	0193100000	A.191
G 25/10.0A/M RT	0193100000	A.304
G 25/2.00A/F BL	0192700000	A.179
G 25/2.00A/F BL	0192700000	A.182
G 25/2.00A/F BL	0192700000	A.187
G 25/2.00A/F BL	0192700000	A.191
G 25/2.00A/F BL	0192700000	A.304
G 25/4.00A/F BR	0192800000	A.179
G 25/4.00A/F BR	0192800000	A.182
G 25/4.00A/F BR	0192800000	A.187
G 25/4.00A/F BR	0192800000	A.191
G 25/4.00A/F BR	0192800000	A.304
G 25/6.30A/F GN	0192900000	A.191
G 25/6.30A/F GN	0192900000	A.304
G-1L+9-1000/10	2657890000	C.25
G-1L+9-1000/16	2657900000	C.25
G-1L+N+9-2L+N+9-3L+N+9-1000/10 C	2658810000	C.31
G-1L+N+9-2L+N+9-3L+N+9-1000/16 C	2658820000	C.31
G-1L+N-2L+N-3L+N-1000/10 C	2658790000	C.31
G-1L+N-2L+N-3L+N-1000/16 C	2658800000	C.31
G-1L-1000/10	2657870000	C.25
G-1L-1000/16	2657880000	C.25
G-1L-106/10	2657770000	C.25
G-1L-106/16	2657780000	C.25
G-1L-160/10	2657790000	C.25
G-1L-160/16	2657800000	C.25
G-1L-210/10	2657810000	C.25
G-1L-210/16	2657820000	C.25
G-1L-268/10	2657830000	C.25
G-1L-268/16	2657840000	C.25
G-1L-27-1000/10	2657910000	C.25
G-1L-27-1000/16	2657920000	C.25
G-1L-320/10	2657850000	C.25
G-1L-320/16	2657860000	C.25
G-2L+9-1000/10	2658170000	C.27
G-2L+9-1000/16	2658180000	C.27
G-2L-1000/10	2658150000	C.27
G-2L-1000/16	2658160000	C.27
G-2L-106/10	2658090000	C.27
G-2L-106/16	2658100000	C.27
G-2L-210/10	2658110000	C.27
G-2L-210/16	2658120000	C.27
G-2L-27-1000/10	2658190000	C.27
G-2L-27-1000/16	2658200000	C.27
G-2L-320/10	2658130000	C.27
G-2L-320/16	2658140000	C.27
G-3L+9-1000/10 C	2658470000	C.29
G-3L+9-1000/16 C	2658480000	C.29
G-3L-1000/10 C	2658450000	C.29
G-3L-1000/16 C	2658460000	C.29
G-3L-106/10 C	2658330000	C.29
G-3L-106/16 C	2658340000	C.29
G-3L-160/10 C	2658350000	C.29
G-3L-160/16 C	2658360000	C.29
G-3L-210/10 C	2658370000	C.29
G-3L-210/16 C	2658380000	C.29
G-3L-268/10 C	2658390000	C.29
G-3L-268/16 C	2658400000	C.29
G-3L-27-1000/10	2658490000	C.29
G-3L-27-1000/16	2658500000	C.29
G-3L-320/10 C	2658410000	C.29
G-3L-320/16 C	2658420000	C.29
G-3L-375/10 C	2658430000	C.29
G-3L-375/16 C	2658440000	C.29
G-4L+9-1000/10 C	2658770000	C.31
G-4L+9-1000/16 C	2658780000	C.31
G-4L-1000/10 C	2658750000	C.31
G-4L-1000/16 C	2658760000	C.31
G-4L-140/10 C	2658690000	C.31
G-4L-140/16 C	2658700000	C.31
G-4L-210/10 C	2658710000	C.31
G-4L-210/16 C	2658720000	C.31
G-4L-285/10 C	2658730000	C.31
G-4L-285/16 C	2658740000	C.31
GHDE ZPS2.5/1AN	1866070000	A.213
GWHE M3 WTL6	1255010000	B.172
GWHE M3 WTL6	1255010000	B.173
GWHE M3 WTL6	1255010000	B.174
GWHE M3 WTL6	1255010000	B.175
GZ 0.5A/F	1460580000	A.191
GZ 0.5A/F	1460580000	A.304
GZ 1.0A/F	1460590000	A.191
GZ 1.0A/F	1460590000	A.304
GZ 10.0A/F	1460640000	A.191
GZ 10.0A/F	1460640000	A.304
GZ 12.5A/F	1460650000	A.191
GZ 12.5A/F	1460650000	A.304
GZ 2.0A/F	1460600000	A.191

Type	Order No.	Page
GZ 2.0A/F	1460600000	A.304
GZ 3.0A/F	1460610000	A.191
GZ 3.0A/F	1460610000	A.304
GZ 5.0A/F	1460620000	A.191
GZ 5.0A/F	1460620000	A.304
GZ 7.0A/F	1460630000	A.191
GZ 7.0A/F	1460630000	A.304
H		
HA ADP WF6/WF10	1781050000	A.366
HA ADP WF6/WF10	1781050000	A.367
HA ADP WF6/WF10	1781050000	A.368
HA ADP WF6/WF10	1781050000	A.369
HA ADP WF6/WF10	1781050000	A.370
HA ADP WF6/WF10	1781050000	A.371
HBT 1,5 - 3,0 RT	1312440000	A.247
HBT 1,5 - 3,0 RT	1312440000	A.300
HBT 1,5 - 3,0 RT	1312440000	A.311
HBT 1,5 - 3,0 RT	1312440000	A.312
HBT 1,5 - 3,0 RT	1312440000	A.313
HBT 1,5 - 4,6 RT	1233340000	A.249
HBT 1,5 - 4,6 RT	1233340000	A.251
HBT 1,5 - 4,6 RT	1233340000	B.173
HBT 1,5 - 4,6 RT	1233340000	B.175
HBT 2,5 - 3,0 BL	1312450000	A.247
HBT 2,5 - 3,0 BL	1312450000	A.300
HBT 2,5 - 3,0 BL	1312450000	A.311
HBT 2,5 - 3,0 BL	1312450000	A.312
HBT 2,5 - 3,0 BL	1312450000	A.313
HBT 2,5 - 4,6 BL	1233330000	A.249
HBT 2,5 - 4,6 BL	1233330000	A.251
HBT 2,5 - 4,6 BL	1233330000	B.173
HBT 2,5 - 4,6 BL	1233330000	B.175
HBT 6,0 - 4,6 GE	1216230000	A.249
HBT 6,0 - 4,6 GE	1216230000	A.251
HBT 6,0 - 4,6 GE	1216230000	B.173
HBT 6,0 - 4,6 GE	1216230000	B.175
HP 1 ADP1	0485560000	C.23
HP 2 ADP2	0485660000	C.23
HP 3 ADP3	0485760000	C.23
HP 4 ADP3	0485860000	C.23
HTF AFK 2.5	9201040000	A.207
HTF ZRV	9014840000	A.206
HTTB 6	2710110000	B.139
HTTB 6 DL	2792460000	A.102
HTTB 6 PE	2710120000	B.139
HTTB 6 PE	2710120000	B.145
HTTB 6 PE DL	2792470000	A.102
HV2700/2-M12 F	2540680000	A.384
HV2700/3-M12 F	2540690000	A.384
HV4000/2-M12 F	2496040000	A.385
HV4000/3-M12 F	2496050000	A.385
I		
IL WMF2.5 BLZ OR	1167440000	B.228
ISPF QB58 SW	0546000000	B.160
ISPF QB58 SW	0546000000	B.161
ISPF QB58 SW	0546000000	B.162
ISPF QB58 SW	0546000000	B.166
J		
JB 25-50	1547500000	B.250
JB 25-50 TH	2762660000	B.250
K		
KDKS 1/35 DB	9532440000	A.301
KDKS 1EN/LLC 10-36V AC/DC	9802720001	A.301
KDKS 1EN/LLC 100-250V AC/DC	9915820001	A.301
KDKS 1EN/LLC 30-70V AC/DC	9908510001	A.301
KDKS 1PE/LLC 10-36V AC/DC	1518300000	A.302
KDKS 1PE/LLC 100-250V AC/DC	1518370000	A.302
KDKS 1PE/LLC 30-70V AC/DC	1518330000	A.302
KDKS 1PE/LLC 60-150V AC/DC	1518340000	A.302
KISC M3X20 SAK10 CU5	0377100000	A.293
KISC M3X20 SAK10 CU5	0377100000	B.163
KISC M3X20 SAK10 CU5	0377100000	B.164
KISC M3X5	1052100000	A.289
KISC M3X5	1052100000	A.290
KISC M3X5	1052100000	A.291
KISC M3X5	1052100000	A.292
KISC M3X5	1052100000	A.294
KISC M3X5	1052100000	A.299
KLBUE 10-20	1600490000	B.236
KLBUE 10-20 CPF	1752701001	B.238
KLBUE 10-20 FM4	1252510000	B.239
KLBUE 10-20 RC TS27	1403050000	B.245
KLBUE 10-20 RC TS35	1403080000	B.247
KLBUE 10-20 SC	1712321001	B.237
KLBUE 15-32	1716300000	B.236
KLBUE 15-32 CPF	1752711001	B.238
KLBUE 15-32 FM4	1252490000	B.239
KLBUE 15-32 SC	1718341001	B.237
KLBUE 2X2-6	1675350000	B.236
KLBUE 3-8	1600480000	B.236
KLBUE 3-8 CPF	1752681001	B.238
KLBUE 3-8 FM4	1252530000	B.239

Type	Order No.	Page
KLBUE 3-8 RC TS27	1403070000	B.246
KLBUE 3-8 RC TS35	1402830000	B.246
KLBUE 3-8 SC	1692261001	B.237
KLBUE 4-13.5	1592810000	B.236
KLBUE 4-13.5 CPF	1752691001	B.238
KLBUE 4-13.5 FM4	1252520000	B.239
KLBUE 4-13.5 RC TS27	1403060000	B.245
KLBUE 4-13.5 RC TS35	1403090000	B.247
KLBUE 4-13.5 SC	1712311001	B.237
KLBUE 4-6 Z/1	2269800000	B.240
KLBUE CO 1	1753311001	B.235
KLBUE CO 2	1752131001	B.235
KLBUE CO 3	1749151001	B.235
KLBUE CO 4	1749161001	B.235
KLBUE CO 5	1755081001	B.235
KLBUE SH1	1856860000	C.12
KOSF ZT2.5	1816150000	A.196
KOSF ZT2.5	1816150000	A.197
KOSF ZT2.5	1816150000	A.199
KOSF ZT2.5	1816150000	A.200
KOSF ZT2.5	1816150000	A.202
KOSF ZT2.5	1816150000	A.203
KOSF ZT2.5	1816150000	A.204
KOSF ZT2.5	1816150000	A.213
KOSF ZT4	1856860000	A.198
KOSF ZT4	1856860000	A.201
KOSF ZT4	1856860000	A.213
KOSF ZT4	1856860000	A.322
KOSF ZT4	1856860000	A.324
KSBR/2 ZTL6	1771820000	B.156
KSBR/2 ZTL6	1771820000	B.157
KSBR/3 ZTL6	1771830000	B.157
KSBR/4 ZTL6	1771840000	B.157
L		
LL TTB 6/1	2710230000	B.134
LL TTB 6/1	2710230000	B.135
LL TTB 6/1	2710230000	B.136
LL TTB 6/1	2710230000	B.137
LL TTB 6/1	2710230000	B.138
LL TTB 6/1	2710230000	B.139
LL TTB 6/1	2710230000	B.142
LL TTB 6/1	2710230000	B.143
LL TTB 6/1	2710230000	B.144
LL TTB 6/2	2710300000	B.134
LL TTB 6/2	2710300000	B.135
LL TTB 6/2	2710300000	B.136
LL TTB 6/2	2710300000	B.137
LL TTB 6/2	2710300000	B.138
LL TTB 6/2	2710300000	B.139
LL TTB 6/2	2710300000	B.142
LL TTB 6/2	2710300000	B.143
LL TTB 6/2	2710300000	B.144
LL TTB 6/2 CM	2710370000	B.134
LL TTB 6/2 CM	2710370000	B.135
LL TTB 6/2 CM	2710370000	B.136
LL TTB 6/2 CM	2710370000	B.137
LL TTB 6/2 CM	2710370000	B.138
LL TTB 6/2 CM	2710370000	B.139
LL TTB 6/2 CM	2710370000	B.142
LL TTB 6/2 CM	2710370000	B.143
LL TTB 6/2 CM	2710370000	B.144
LL TTB 6/3	2710440000	B.134
LL TTB 6/3	2710440000	B.136
LL TTB 6/3	2710440000	B.138
LL TTB 6/3	2710440000	B.142
LL TTB 6/3	2710440000	B.144
LL TTB 6/3 CM	2726100000	B.134
LL TTB 6/3 CM	2726100000	B.136
LL TTB 6/3 CM	2726100000	B.138
LL TTB 6/3 CM	2726100000	B.142
LL TTB 6/3 CM	2726100000	B.144
LL TTB 6/4	2710450000	B.134
LL TTB 6/4	2710450000	B.136
LL TTB 6/4	2710450000	B.138
LL TTB 6/4	2710450000	B.142
LL TTB 6/4	2710450000	B.144
LL TTB 6/4 CM	2726110000	B.134
LL TTB 6/4 CM	2726110000	B.136
LL TTB 6/4 CM	2726110000	B.138
LL TTB 6/4 CM	2726110000	B.142
LL TTB 6/4 CM	2726110000	B.144
LL TTB 6/6	2710460000	B.134
LL TTB 6/6	2710460000	B.136
LL TTB 6/6	2710460000	B.138
LL TTB 6/6	2710460000	B.142
LL TTB 6/6	2710460000	B.144
LS 2.8 WDU2.5-10	1056400000	A.331
M		
MAK 2.5 DB	7917030000	A.271
MAK 2.5 DB	7917030000	B.97
MARK-C. 25X25X2.5 B/DR.	1700530001	A.309
MARK-C. 50X50X5 B/DR.	1700540001	A.379

Type	Order No.	Page
PRV 16 SW 35X15 RT/WS	1173620000	B.218
PRV 16 SW 35X15 WS/RT	1173650000	B.218
PRV 16 SW 35X7.5 RT/WS	1173680000	B.218
PRV 16 SW 35X7.5 WS/RT	1173710000	B.218
PRV 4 BL 35X15 RT	1267890000	B.216
PRV 4 BL 35X15 WS	1173920000	B.216
PRV 4 BL 35X7.5 RT	1267900000	B.216
PRV 4 BL 35X7.5 WS	1173930000	B.216
PRV 4 SW 35X15 RT	1173810000	B.216
PRV 4 SW 35X15 WS	1173820000	B.216
PRV 4 SW 35X7.5 RT	1173830000	B.216
PRV 4 SW 35X7.5 WS	1173840000	B.216
PRV 8 BL 35X15 RT/WS	1267830000	B.217
PRV 8 BL 35X15 WS/RT	1173900000	B.217
PRV 8 BL 35X7.5 RT/WS	1267840000	B.217
PRV 8 BL 35X7.5 WS/RT	1173910000	B.217
PRV 8 SW 35X15 RT/WS	1173740000	B.217
PRV 8 SW 35X15 WS/RT	1173780000	B.217
PRV 8 SW 35X7.5 RT/WS	1173790000	B.217
PRV 8 SW 35X7.5 WS/RT	1173800000	B.217
PS 2.0 MC	0310000000	A.6
PS 2.0 MC	0310000000	A.7
PS 2.0 MC	0310000000	A.8
PS 2.0 MC	0310000000	A.9
PS 2.0 MC	0310000000	A.10
PS 2.0 MC	0310000000	A.11
PS 2.0 MC	0310000000	A.12
PS 2.0 MC	0310000000	A.16
PS 2.0 MC	0310000000	A.17
PS 2.0 MC	0310000000	A.18
PS 2.0 MC	0310000000	A.19
PS 2.0 MC	0310000000	A.20
PS 2.0 MC	0310000000	A.21
PS 2.0 MC	0310000000	A.22
PS 2.0 MC	0310000000	A.23
PS 2.0 MC	0310000000	A.24
PS 2.0 MC	0310000000	A.25
PS 2.0 MC	0310000000	A.26
PS 2.0 MC	0310000000	A.27
PS 2.0 MC	0310000000	A.28
PS 2.0 MC	0310000000	A.29
PS 2.0 MC	0310000000	A.30
PS 2.0 MC	0310000000	A.31
PS 2.0 MC	0310000000	A.32
PS 2.0 MC	0310000000	A.33
PS 2.0 MC	0310000000	A.34
PS 2.0 MC	0310000000	A.35
PS 2.0 MC	0310000000	A.36
PS 2.0 MC	0310000000	A.37
PS 2.0 MC	0310000000	A.38
PS 2.0 MC	0310000000	A.39
PS 2.0 MC	0310000000	A.40
PS 2.0 MC	0310000000	A.41
PS 2.0 MC	0310000000	A.42
PS 2.0 MC	0310000000	A.43
PS 2.0 MC	0310000000	A.44
PS 2.0 MC	0310000000	A.46
PS 2.0 MC	0310000000	A.47
PS 2.0 MC	0310000000	A.48
PS 2.0 MC	0310000000	A.49
PS 2.0 MC	0310000000	A.50
PS 2.0 MC	0310000000	A.51
PS 2.0 MC	0310000000	A.52
PS 2.0 MC	0310000000	A.53
PS 2.0 MC	0310000000	A.54
PS 2.0 MC	0310000000	A.55
PS 2.0 MC	0310000000	A.56
PS 2.0 MC	0310000000	A.57
PS 2.0 MC	0310000000	A.58
PS 2.0 MC	0310000000	A.59
PS 2.0 MC	0310000000	A.60
PS 2.0 MC	0310000000	A.61
PS 2.0 MC	0310000000	A.62
PS 2.0 MC	0310000000	A.63
PS 2.0 MC	0310000000	A.64
PS 2.0 MC	0310000000	A.66
PS 2.0 MC	0310000000	A.67
PS 2.0 MC	0310000000	A.68
PS 2.0 MC	0310000000	A.69
PS 2.0 MC	0310000000	A.92
PS 2.0 MC	0310000000	A.93
PS 2.0 MC	0310000000	A.94
PS 2.0 MC	0310000000	A.95
PS 2.0 MC	0310000000	A.103
PS 2.0 MC	0310000000	B.8
PS 2.0 MC	0310000000	B.9
PS 2.0 MC	0310000000	B.10
PS 2.0 MC	0310000000	B.11
PS 2.0 MC	0310000000	B.12
PS 2.0 MC	0310000000	B.16
PS 2.0 MC	0310000000	B.17
PS 2.0 MC	0310000000	B.18
PS 2.0 MC	0310000000	B.19
PS 2.0 MC	0310000000	B.20
PS 2.0 MC	0310000000	B.21
PS 2.0 MC	0310000000	B.24
PS 2.0 MC	0310000000	B.52
PS 2.0 MC	0310000000	B.94
PS 2.0 MC	0310000000	B.102

Type	Order No.	Page
PS 2.0 MC	0310000000	B.103
PS 2.0 MC	0310000000	B.104
PS 2.0 MC	0310000000	B.105
PS 2.0 MC	0310000000	B.108
PS 2.0 MC	0310000000	B.109
PS 2.0 MC	0310000000	B.110
PS 2.0 MC	0310000000	B.114
PS 2.0 MC	0310000000	B.115
PS 2.0 MC	0310000000	B.116
PS 2.0 MC	0310000000	B.118
PS 2.0 MC	0310000000	B.184
PS 2.0 MC	0310000000	B.185
PS 2.0 MC	0310000000	B.252
PS 2.0 MC	0310000000	B.253
PS 2.0 MC	0310000000	B.256
PS 2.0 MC	0310000000	B.257
PS 2.0 MC	0310000000	B.258
PS 2.0 MC	0310000000	B.259
PS 2.0 MC	0310000000	B.260
PS 2.0 MC	0310000000	B.261
PS 2.0 MC	0310000000	B.278
PS 2.0 MC	0310000000	B.279
PS 2.0 MC	0310000000	B.280
PS 2.0 MC	0310000000	B.281
PS 2.0 MC	0310000000	B.282
PS 2.0 MC	0310000000	B.283
PS 2.0 MC	0310000000	B.284
PS 2.0 MC	0310000000	B.285
PS 2.0 MC	0310000000	B.286
PS 2.0 MC	0310000000	B.287
PS 2.0 MC	0310000000	B.288
PS 2.0 MC	0310000000	B.289
PS 2.0 MC	0310000000	B.297
PS 2.0 OR	0293800000	A.233
PS 2.3 RT	0180400000	A.134
PS 2.3 RT	0180400000	A.135
PS 2.3 RT	0180400000	A.192
PS 2.3 RT	0180400000	A.193
PS 2.3 RT	0180400000	A.194
PS 2.3 RT	0180400000	A.205
PS 2.3 RT	0180400000	A.233
PS 2.3 RT	0180400000	A.240
PS 2.3 RT	0180400000	A.242
PS 2.3 RT	0180400000	A.244
PS 2.3 RT	0180400000	A.308
PS 2.3 RT	0180400000	A.309
PS 2.3 RT	0180400000	A.310
PS 2.3 RT	0180400000	A.311
PS 2.3 RT	0180400000	A.312
PS 2.3 RT	0180400000	A.318
PS 2.3 RT	0180400000	A.319
PS 2.3 RT	0180400000	A.158
PS 4 F.STB 4	0299600000	B.157
PS 4 F.STB 4	0299600000	B.160
PS 4 F.STB 4	0299600000	B.164
PS 4 F.STB 4	0299600000	B.177
PS_Z0V	1121740000	A.234
PS_Z0V_SET	1116710000	A.234

Q

Q 10 AKZ1.5	0368500000	A.240
Q 10 AKZ1.5	0368500000	A.242
Q 10 AKZ1.5	0368500000	A.350
Q 10 AKZ4	0368600000	A.244
Q 10 AKZ4	0368600000	A.350
Q 10 AKZ4SS	0369300000	A.265
Q 10 AKZ4SS	0369300000	A.350
Q 10 DLI	1313100000	A.350
Q 10 DLI	1313100000	B.190
Q 10 DLI	1313100000	B.191
Q 10 DLI	1313100000	B.192
Q 10 DLI	1313100000	B.193
Q 10 WDL2.5S	1071800000	A.350
Q 10 WDL2.5S	1071800000	B.302
Q 10 WDL2.5S	1071800000	B.303
Q 10 WDL2.5S	1071800000	B.304
Q 10 WDL2.5S	1071800000	B.305
Q 2 AKZ1.5	0368200000	A.240
Q 2 AKZ1.5	0368200000	A.242
Q 2 AKZ1.5	0368200000	A.350
Q 2 AKZ4	0336400000	A.244
Q 2 AKZ4	0336400000	A.350
Q 2 AKZ4SS	0369000000	A.265
Q 2 AKZ4SS	0369000000	A.350
Q 2 DLI	1312500000	A.350
Q 2 DLI	1312500000	B.190
Q 2 DLI	1312500000	B.191
Q 2 DLI	1312500000	B.192
Q 2 DLI	1312500000	B.193
Q 2 WDL2.5S	1071500000	A.350
Q 2 WDL2.5S	1071500000	B.302
Q 2 WDL2.5S	1071500000	B.303
Q 2 WDL2.5S	1071500000	B.304
Q 2 WDL2.5S	1071500000	B.305
Q 20 DLI	1399800000	A.350
Q 20 WDL2.5S	1074200000	A.350
Q 20 WDL2.5S	1074200000	B.302
Q 20 WDL2.5S	1074200000	B.303

Type	Order No.	Page
Q 20 WDL2.5S	1074200000	B.304
Q 20 WDL2.5S	1074200000	B.305
Q 3 AKZ1.5	0368300000	A.350
Q 3 AKZ4	0336500000	A.350
Q 3 DLI	1312600000	A.350
Q 3 DLI	1312600000	B.190
Q 3 DLI	1312600000	B.191
Q 3 DLI	1312600000	B.192
Q 3 DLI	1312600000	B.193
Q 3 WDL2.5S	1071600000	A.350
Q 3 WDL2.5S	1071600000	B.302
Q 3 WDL2.5S	1071600000	B.303
Q 3 WDL2.5S	1071600000	B.304
Q 3 WDL2.5S	1071600000	B.305
Q 4 AKZ1.5	0368400000	A.350
Q 4 AKZ4	0336600000	A.350
Q 4 DLI	1312700000	A.350
Q 4 DLI	1312700000	B.190
Q 4 DLI	1312700000	B.191
Q 4 DLI	1312700000	B.192
Q 4 DLI	1312700000	B.193
Q 4 WDL2.5S	1071700000	A.350
Q 4 WDL2.5S	1071700000	B.302
Q 4 WDL2.5S	1071700000	B.303
Q 4 WDL2.5S	1071700000	B.304
Q 4 WDL2.5S	1071700000	B.305
Q WDU10-2.5 SET	1859620000	A.351
Q WDU10-4 SET	1859610000	A.352
Q WDU6-2.5 SET	1859600000	A.351
QB 58/8/15	0545400000	B.160
QB 58/8/15	0545400000	B.161
QB 58/8/9/WI	0545300000	B.160
QB 58/8/9/WI	0545300000	B.161
QB 58/8/9/WI	0545300000	B.162
QB 58/8/9/WI	0545300000	B.166
QL 10 SAK16	0471000000	A.291
QL 10 SAK16	0471000000	A.292
QL 10 SAK16	0471000000	A.294
QL 10 SAK6N	0338300000	A.289
QL 10 SAK6N	0338300000	A.290
QL 10 SAK6N	0338300000	A.293
QL 10 SAK6N	0338300000	B.163
QL 10 SAK6N	0338300000	B.171
QL 10 SAKS2	0338900000	A.297
QL 10 SAKS2	0338900000	A.298
QL 10 SAKS4	0339000000	A.297
QL 15 SAK6N	0221200000	B.171
QL 2 SAK16	0470700000	A.291
QL 2 SAK16	0470700000	A.292
QL 2 SAK16	0470700000	A.294
QL 2 SAK6N	0194300000	A.289
QL 2 SAK6N	0194300000	A.290
QL 2 SAK6N	0194300000	A.293
QL 2 SAK6N	0194300000	B.163
QL 2 SAK6N	0194300000	B.171
QL 2 SAKS2	0207800000	A.297
QL 2 SAKS2	0207800000	A.298
QL 2 SAKS4	0328000000	A.297
QL 3 SAK6N	0194400000	B.163
QL 3 SAK6N	0194400000	B.171
QL 4 SAK6N	0194500000	B.163
QL 4 SAK6N	0194500000	B.171
QS 2/10/4	0270860000	B.171
QS 2/12/4	0270760000	B.171
QS 2/8/4	0270960000	B.160
QS 2/8/4	0270960000	B.161
QS 2/8/4	0270960000	B.171
QVS 2 SAKT1+2	0307300000	B.162
QVS 2 SAKT1+2	0307300000	B.163
QVS 2 SAKT1+2	0307300000	B.164
QVS 2 SAKT1+2	0307300000	B.170
QVS 2/4 SAKT4	1319260000	B.158
QVS 2/S SAKT1+2	0358460000	B.170
QVS 3 SAKT1+2	0329300000	B.163
QVS 3 SAKT1+2	0329300000	B.164
QVS 3 SAKT1+2	0329300000	B.170
QVS 4 SAKT1+2	0307400000	B.170
QVSK 2 SAKT1	1670360000	B.170

R

RAHE LN WDT1.5	1865410000	A.314
RAHE LN WDT1.5	1865410000	A.315
RAILASSEMBLER	2738690000	A.99
RAILLASER	2705010000	A.100
REMOVAL TOOL AFK	1866760000	A.207

S

S-1L+9-1000/10	2658050000	C.26
S-1L+9-1000/16	2658060000	C.26
S-1L-1000/10	2658030000	C.26
S-1L-1000/16	2658040000	C.26
S-1L-106/10	2657930000	C.26
S-1L-106/16	2657940000	C.26
S-1L-160/10	2657950000	C.26
S-1L-160/16	2657960000	C.26
S-1L210/10	2657970000	C.26
S-1L210/16	2657980000	C.26

Type	Order No.	Page	Type	Order No.	Page	Type	Order No.	Page	Type	Order No.	Page
SDS 1.0X5.5X150	2749380000	B.21	SIHA 3/G20/LD 10-36V	7921570000	B.220	SL TTB 6	2710220000	B.137	SS M3 D 128-A 3	0164400000	A.292
SDS 1.0X5.5X150	2749380000	B.22	SIHA 3/G20/LD 10-36V	7921570000	B.221	SL TTB 6	2710220000	B.138	SS M3 D 128-A 3	0164400000	A.294
SDS 1.0X5.5X150	2749380000	B.23	SIHA 3/G20/LD 10-36V	7921570000	B.222	SL TTB 6	2710220000	B.139	SS M4 D 128-A 4	0136400000	A.297
SDS 1.0X5.5X150	2749380000	B.24	SIHA 3/G20/LD 10-36V	7921570000	B.223	SL TTB 6	2710220000	B.142	SS M4 D 128-A 4	0136400000	A.298
SDS 1.0X5.5X150	2749380000	B.96	SIHA 3/G20/LD 10-36V	7921570000	B.224	SL TTB 6	2710220000	B.143	SSCH 10X3X1000 CU/SN	0348900000	B.235
SDS 1.0X5.5X150	2749380000	B.181	SIHA 3/G20/LD 10-36V	7921570000	B.225	SL TTB 6	2710220000	B.145	SSCH 10X3X1000 CU/SN	0348900000	B.236
SDS 1.0X5.5X150	2749380000	B.259	SIHA 3/G20/LD 10-36V	7921570000	B.290	SM 27/8 K MC NE WS	1812630000	B.245	SSCH 10X3X1000 CU/SN	0348900000	B.242
SDS 1.0X5.5X150	2749380000	B.260	SIHA 3/G20/LD 10-36V	7921570000	B.291	SM 27/8 K MC NE WS	1812630000	B.246	SSCH 10X3X1000 CU/SN	0348900000	B.243
SDS 1.0X5.5X150	2749380000	B.261	SIHA 3/G20/LD 10-36V	7921570000	B.292	SM 27/8 K MC NE WS	1812630000	B.247	SSCH 10X3X1000 CU/SN	0348900000	B.278
SDS 1.2X6.5X150	2749390000	A.278	SIHA 3/G20/LD 10-36V	7921570000	B.293	SMSE WF 10/2XM6	1868880000	A.369	SSCH 10X3X1000 CU/SN	0348900000	B.279
SDS 1.2X6.5X150	2749390000	A.279	SIHA 3/G20/LD 140-250V	7921600000	A.70	SMSE WF 10/2XM6	1868880000	A.377	SSCH 10X3X1000 CU/SN	0348900000	B.280
SDS 1.2X6.5X150	2749390000	B.32	SIHA 3/G20/LD 140-250V	7921600000	A.71	SMSE WSH 135/60 MT	1246990000	B.243	SSCH 10X3X1000 CU/SN	0348900000	B.281
SDS 1.2X6.5X150	2749390000	B.33	SIHA 3/G20/LD 140-250V	7921600000	A.192	SMSE WSH U1 MT	1083990000	B.243	SSCH 10X3X1000 CU/SN	0348900000	B.282
SDS 1.2X6.5X150	2749390000	B.179	SIHA 3/G20/LD 140-250V	7921600000	A.193	SNAPMARK 1.5	2682080000	A.32	SSCH 10X3X1000 CU/SN	0348900000	B.283
SDS 1.2X6.5X150	2749390000	B.269	SIHA 3/G20/LD 140-250V	7921600000	A.205	SNAPMARK 1.5	2682080000	A.33	SSCH 10X3X1000 CU/SN	0348900000	B.284
SEP 2C 2.5	2751080000	A.6	SIHA 3/G20/LD 140-250V	7921600000	A.236	SNAPMARK 1.5	2682080000	A.40	SSCH 10X3X1000 CU/SN	0348900000	B.285
SEP 2C 2.5	2751080000	A.10	SIHA 3/G20/LD 140-250V	7921600000	A.308	SNAPMARK 1.5	2682080000	A.41	SSCH 10X3X1000 CU/SN	0348900000	B.286
SEP 2C 4	2874790000	A.7	SIHA 3/G20/LD 140-250V	7921600000	A.309	SNAPMARK 1.5	2682080000	A.56	SSCH 10X3X1000 CU/SN	0348900000	B.287
SEP 2C 4	2874790000	A.11	SIHA 3/G20/LD 140-250V	7921600000	A.310	SNAPMARK 1.5	2682080000	A.57	SSCH 10X3X1000 CU/SN	0348900000	B.288
SEP 2T 2.5	2902630000	A.8	SIHA 3/G20/LD 140-250V	7921600000	A.311	SNAPMARK 1.5	2682080000	A.59	SSCH 10X3X1000 CU/SN	0348900000	B.289
SEP 2T 2.5	2902630000	A.9	SIHA 3/G20/LD 140-250V	7921600000	A.316	SNAPMARK 1.5	2682080000	A.74	SSCH 10X3X1000 CU/SN	0348900000	B.298
SEP 2T 2.5	2902630000	A.12	SIHA 3/G20/LD 140-250V	7921600000	A.318	SNAPMARK 1.5	2682080000	A.75	SSCH 10X3X1000 CU/SN	0348900000	B.299
SEP 3C 2.5	2751090000	A.6	SIHA 3/G20/LD 140-250V	7921600000	A.319	SNAPMARK 1.5	2682080000	A.117	SSCH 10X3X1000 CU/SN	0348900000	B.300
SEP 3C 2.5	2751090000	A.10	SIHA 3/G20/LD 140-250V	7921600000	A.356	SNAPMARK I	1805880000	A.8	SSCH 10X3X1000 CU/SN	0348900000	B.304
SEP 3C 4	2874800000	A.7	SIHA 3/G20/LD 140-250V	7921600000	B.205	SNAPMARK I	1805880000	A.9	SSCH 10X3X1000 CU/SN	0348900000	B.305
SEP 3C 4	2874800000	A.11	SIHA 3/G20/LD 140-250V	7921600000	B.206	SNAPMARK I	1805880000	A.12	SSCH 10X3X1000 CU/SN	0348900000	C.12
SEP 4C 2.5	2751100000	A.7	SIHA 3/G20/LD 140-250V	7921600000	B.207	SNAPMARK I	1805880000	A.38	SSCH 10X3X1000 ST/ZN	0438000000	C.12
SEP 4C 2.5	2751100000	A.11	SIHA 3/G20/LD 140-250V	7921600000	B.211	SNAPMARK I	1805880000	A.39	SSCH 10X3X2000 CU VERZ.	1397000000	C.12
SEP 4C 4	2874810000	A.8	SIHA 3/G20/LD 140-250V	7921600000	B.212	SNAPMARK I	1805880000	A.42	SSCH 15X6X1000 CU/SN	0357400000	C.12
SEP 4C 4	2874810000	A.12	SIHA 3/G20/LD 140-250V	7921600000	B.220	SNAPMARK I	1805880000	A.43	SSCH 6X6X1000 CU/SN	0571300000	C.12
SEP SDL 4	2615020000	B.180	SIHA 3/G20/LD 140-250V	7921600000	B.221	SNAPMARK I	1805880000	A.44	SSCH 7.3X1.2X1000	1071200000	A.330
SEP SDL 4	2615020000	B.181	SIHA 3/G20/LD 140-250V	7921600000	B.222	SNAPMARK I	1805880000	A.58	SNAPMARK 1.5	1071200000	C.12
SEP SRL 3	2614990000	A.361	SIHA 3/G20/LD 140-250V	7921600000	B.223	SNAPMARK I	1805880000	A.59	SSI 4	2615270000	B.180
SEP SRL 4	2615000000	A.361	SIHA 3/G20/LD 140-250V	7921600000	B.224	SNAPMARK I	1805880000	A.78	SSP 3 SAKT1	0531760000	B.162
SEP SRL 4	2615000000	A.362	SIHA 3/G20/LD 140-250V	7921600000	B.225	SNAPMARK I	1805880000	A.79	SSP 3 SAKT1	0531760000	B.164
SEP SRL 6	2615010000	A.362	SIHA 3/G20/LD 140-250V	7921600000	B.290	SNAPMARK I	1805880000	A.82	SSP 3 SAKT1	0531760000	B.166
SET AAP11 6/1.5/12C	2506090000	B.106	SIHA 3/G20/LD 140-250V	7921600000	B.291	SNAPMARK I	1805880000	A.83	SSP 3 SAKT1	0531760000	B.170
SET AAP11 6/1.5/24C	2506370000	B.106	SIHA 3/G20/LD 140-250V	7921600000	B.292	SNAPMARK I	1805880000	A.92	SSP 3 SAKT1	0531760000	B.172
SET AAP12 10/2.5/10C	2506350000	B.112	SIHA 3/G20/LD 140-250V	7921600000	B.293	SNAPMARK I	1805880000	A.93	SSP 3 SAKT1	0531760000	B.174
SET AAP13 6/1.5/12C	2506340000	B.107	SIHA 3/G20/LD 35-70V	7921580000	A.70	SNAPMARK I	1805880000	A.94	SSP 3 WTL6/2	1604200000	B.170
SET AAP13 6/1.5/24C	2506380000	B.107	SIHA 3/G20/LD 35-70V	7921580000	A.71	SNAPMARK I	1805880000	A.95	SSP WTL6/2	1604200000	B.176
SET AAP14 10/2.5/10C	2506360000	B.113	SIHA 3/G20/LD 35-70V	7921580000	A.236	SNAPMARK I	1805880000	A.117	SSP WTL6/2	1604200000	B.177
SH 1	0289860000	C.12	SIHA 3/G20/LD 35-70V	7921580000	A.316	SNAPMARK I	1805880000	A.153	SSP ZTL6	1771860000	B.156
SH 2	0494920000	C.13	SIHA 3/G20/LD 35-70V	7921580000	A.356	SNAPMARK I	1805880000	A.158	SSP ZTL6	1771860000	B.157
SH 2 S	0641720000	C.13	SIHA 3/G20/LD 35-70V	7921580000	B.205	SNAPMARK I	1805880000	A.159	ST 4000/L C160	2563940000	A.383
SH 3	0556660000	C.13	SIHA 3/G20/LD 35-70V	7921580000	B.206	SNAPMARK I	1805880000	A.176	ST 4000/L CB M12/6	2564000000	A.383
SH 4C	1340870000	B.241	SIHA 3/G20/LD 35-70V	7921580000	B.207	SNAPMARK I	1805880000	B.94	ST 4000/L E180	2563920000	A.383
SIHA 1/G20	9537550000	A.309	SIHA 3/G20/LD 35-70V	7921580000	B.211	SO SH1	0401460000	C.12	ST 4000/L J2 M12	2564100000	A.383
SIHA 1/G20	9537550000	A.356	SIHA 3/G20/LD 35-70V	7921580000	B.212	SP M6 15 MSZM	3896100000	B.241	ST 4000/L J3 M12	2564110000	A.383
SIHA 1/G20 10-36V	9537560000	A.309	SIHA 3/G20/LD 60-150V	7921590000	A.70	SP M6 20 MSZM	3896200000	B.241	ST 4000/L J4 M12	2564120000	A.383
SIHA 1/G20 10-36V	9537560000	A.356	SIHA 3/G20/LD 60-150V	7921590000	A.71	SP M6 30 MSZM	3896300000	B.241	ST 4000/L M12	2563880000	A.383
SIHA 3/G20	7921560000	A.70	SIHA 3/G20/LD 60-150V	7921590000	A.236	SOB 3/2	2615110000	A.361	ST 4000/L M12 F	2743200000	A.383
SIHA 3/G20	7921560000	A.71	SIHA 3/G20/LD 60-150V	7921590000	A.316	SOB 3/3	2615120000	A.361	ST 4000/L P180	2563900000	A.383
SIHA 3/G20	7921560000	A.192	SIHA 3/G20/LD 60-150V	7921590000	A.356	SOB 3/4	2615130000	A.361	ST 4000/L S180	2564180000	A.383
SIHA 3/G20	7921560000	A.193	SIHA 3/G20/LD 60-150V	7921590000	B.205	SOB 4/2	2615140000	A.361	ST 4000/S C130	2563930000	A.382
SIHA 3/G20	7921560000	A.205	SIHA 3/G20/LD 60-150V	7921590000	B.206	SOB 4/2	2615140000	A.362	ST 4000/S CB M10/4	2563960000	A.382
SIHA 3/G20	7921560000	A.236	SIHA 3/G20/LD 60-150V	7921590000	B.207	SOB 4/2	2615140000	B.181	ST 4000/S CB M10/6	2563970000	A.382
SIHA 3/G20	7921560000	A.308	SIHA 3/G20/LD 60-150V	7921590000	B.211	SOB 4/3	2615150000	A.361	ST 4000/S CB M8/4	2563950000	A.382
SIHA 3/G20	7921560000	A.309	SIHA 3/G20/LD 60-150V	7921590000	B.212	SOB 4/3	2615150000	A.362	ST 4000/S E150	2563910000	A.382
SIHA 3/G20	7921560000	A.310	SIHA STRAP	9537680000	A.236	SOB 4/3	2615150000	B.181	ST 4000/S J2 M8	2564010000	A.382
SIHA 3/G20	7921560000	A.311	SIHA STRAP	9537680000	A.356	SOB 4/4	2615160000	A.361	ST 4000/S J3 M8	2564020000	A.382
SIHA 3/G20	7921560000	A.316	SK E14 SAK54	0339410000	A.297	SOB 4/4	2615160000	A.362	ST 4000/S M10	2563860000	A.382
SIHA 3/G20	7921560000	A.318	SK E16/SAK52	0284110000	A.297	SOB 4/4	2615160000	B.181	ST 4000/S M10 F	2743190000	A.382
SIHA 3/G20	7921560000	A.319	SK E18 SAK55	0359310000	A.298	SOB 4/2	2615250000	A.362	ST 4000/S M8	2563830000	A.382
SIHA 3/G20	7921560000	A.356	SK WSD-S 1,5-10,0	9008850000	B.38	SOB 4/2	2615250000	B.180	ST 4000/S M8 F	2743180000	A.382
SIHA 3/G20	7921560000	B.205	SK WSD-S 1,5-10,0	9008850000	B.39	SOB 4/2	2615250000	B.181	ST 4000/S P150	2563890000	A.382
SIHA 3/G20	7921560000	B.206	SK WSD-S 1,5-10,0	9008850000	B.42	SOB 4/4	2615260000	A.362	ST 4000/S S150	2564170000	A.382
SIHA 3/G20	7921560000	B.207	SK WSD-S 1,5-10,0	9008850000	B.43	SOB 4/4	2615260000	B.180	STB 14/D6/4/M3 SAK10	0169900000	B.162
SIHA 3/G20	7921560000	B.211	SK WSD-S 1,5-10,0	9008850000	B.46	SOB 4/4	2615260000	B.181	STB 14/D6/4/M3 SAK10	0124200000	B.167
SIHA 3/G20	7921560000	B.212	SK WSD-S 1,5-10,0	9008850000	B.48	SOV 3/10	2615070000	A.361	STB 14/D6/4/M3 SAK10	0124200000	B.168
SIHA 3/G20	7921560000	B.220	SK WSD-S 1,5-10,0	9008850000	B.66	SOV 3/2	2615030000	A.361	STB 14/D6/4/M3 SAK10	0124200000	B.169
SIHA 3/G20	7921560000	B.221	SK WSD-S 1,5-10,0	9008850000	B.68	SOV 3/3	2615040000	A.361	STB 14/D6/4/M3 SAK10	0169900000	B.170
SIHA 3/G20	7921560000	B.222	SK WSD-S 1,5-10,0	9008850000	B.69	SOV 3/4	2615050000	A.361	STB 21.6/45 BL	1936290000	B.167
SIHA 3/G20	7921560000	B.223	SK WSD-S 1,5-10,0	9008850000	B.72	SOV 6/2	2615080000	A.362	STB 21.6/45 BL	1936290000	B.168
SIHA 3/G20	7921560000	B.224	SK WSD-S 1,5-10,0	9008850000	B.73	SOV 6/3	2615090000	A.362	STB 21.6/45 BL	1936290000	B.169
SIHA 3/G20	7921560000	B.225	SK WSD-S 1,5-10,0								

Type	Order No.	Page	Type	Order No.	Page	Type	Order No.	Page	Type	Order No.	Page
W2T 4 FS-FT-PE 100-250V BK	2894090000	B.215	WAD 8 MC NE WS	1112940000	B.180	WAP 2.5-10 BL	1050080000	A.245	WAP WTL6/1	1068300000	B.163
W2T 4 FS-FT-PE 100-250V BK STB	2894140000	B.215	WAD WDU1.5/BLZ/BLA	1577400000	A.329	WAP 2.5-10 BL	1050080000	A.248	WAP WTL6/1	1068300000	B.164
W2T 4 FS-FT-PE 30-70V BK	2894070000	B.215	WAD WMF2.5	1142970000	A.228	WAP 2.5-10 BL	1050080000	A.250	WAP WTL6/1 EN	1957710000	B.166
W2T 4 FS-FT-PE 30-70V BK STB	2894120000	B.215	WAH 120	1064660000	B.378	WAP 2.5-10 BL	1050080000	A.251	WAP WTL6/1 EN	1957710000	B.167
W2T 4 FS-FT-PE 60-150V BK	2894080000	B.215	WAH 120	1064660000	A.374	WAP 2.5-10 BL	1050080000	A.326	WAP WTL6/1 EN	1957710000	B.168
W2T 4 FS-FT-PE 60-150V BK STB	2894130000	B.215	WAH 120	1064660000	A.379	WAP 2.5-10 BL	1050080000	B.262	WAP WTL6/1 EN	1957710000	B.169
W2T 4 FS-FT-PE BK	2894050000	B.215	WAH 185/300 BE	1064760000	A.374	WAP 2.5-10 BL	1050080000	B.298	WAP WTR2.5/ZZ	1074600000	A.309
W2T 4 FS-FT-PE BK STB	2894100000	B.215	WAH 185/300 BE	1064760000	A.375	WAP 2.5-10 BL	1050080000	B.299	WBB WDK2.5/BL5.08	1072660000	A.329
WAD 12 MC B GE/SW	2445090000	A.252	WAH 185/300 BE	1064760000	A.379	WAP 2.5-10 BL	1050080000	B.300	WBB WDU1.5/BL...	1068160000	A.328
WAD 12 MC B GE/SW	2445090000	A.253	WAH 35	1064460000	A.372	WAP 2.5-10 SW	1050010000	A.300	WBB WMF2.5 BLZ	1142980000	B.228
WAD 12 MC B GE/SW	2445090000	A.254	WAH 35	1064460000	A.379	WAP WDK 2.5M/TR-DU	1839850000	A.318	WBB ZA WDK2.5/BL5.08	1072760000	A.329
WAD 12 MC B GE/SW	2445090000	A.255	WAH 70 BE	1064560000	A.373	WAP WDK 2.5M/TR-DU	1839850000	A.319	WBB ZA WDU1.5/BL 10/10	1068260000	A.328
WAD 12 MC B GE/SW	2445090000	B.26	WAH 70 BE	1064560000	A.379	WAP WDK1.5/R3.5	1754200000	A.262	WBBD 16 BL	2603850000	C.14
WAD 12 MC B GE/SW	2445090000	B.27	WAP 16+35 WTW 2.5-10	1050100000	A.241	WAP WDK10	1186720000	A.267	WBBD 16 GN	2603860000	C.14
WAD 12 MC B GE/SW	2445090000	B.263	WAP 16+35 WTW 2.5-10	1050100000	A.242	WAP WDK10	1186720000	A.268	WBBD 16 GY	2603840000	C.14
WAD 12 MC B GE/SW	2445090000	B.264	WAP 16+35 WTW 2.5-10	1050100000	A.243	WAP WDK10	1186720000	A.269	WD 1 25 K KARTE A 6 ST	1563900000	A.372
WAD 12 MC NE WS	2445070000	A.252	WAP 16+35 WTW 2.5-10	1050100000	A.245	WAP WDK10	1186720000	A.270	WD 1 25 K KARTE A 6 ST	1563900000	A.373
WAD 12 MC NE WS	2445070000	A.253	WAP 16+35 WTW 2.5-10	1050100000	A.247	WAP WDK10	1186720000	A.271	WD 1 25 K KARTE A 6 ST	1563900000	A.374
WAD 12 MC NE WS	2445070000	A.254	WAP 16+35 WTW 2.5-10	1050100000	A.248	WAP WDK10	1186720000	A.283	WD 1 25 K KARTE A 6 ST	1563900000	A.375
WAD 12 MC NE WS	2445070000	A.255	WAP 16+35 WTW 2.5-10	1050100000	A.249	WAP WDK10	1186720000	B.96	WAP WDK1.5/R3.5	1753290000	A.262
WAD 12 MC NE WS	2445070000	B.26	WAP 16+35 WTW 2.5-10	1050100000	A.250	WAP WDK10 BL	1186730000	A.267	WDK 10	1186740000	A.267
WAD 12 MC NE WS	2445070000	B.27	WAP 16+35 WTW 2.5-10	1050100000	A.251	WAP WDK10 BL	1186730000	A.268	WDK 10 BL	1186750000	A.267
WAD 12 MC NE WS	2445070000	B.263	WAP 16+35 WTW 2.5-10	1050100000	A.252	WAP WDK10 BL	1186730000	A.269	WDK 10 DU/N	1415520000	A.269
WAD 12 MC NE WS	2445070000	B.264	WAP 16+35 WTW 2.5-10	1050100000	A.253	WAP WDK10 BL	1186730000	A.270	WDK 10 DU/PE	1415480000	A.270
WAD 12N GE BED	1073200000	B.263	WAP 16+35 WTW 2.5-10	1050100000	A.254	WAP WDK10 BL	1186730000	A.271	WDK 10 L	1415510000	A.268
WAD 12N WS	1073290000	B.263	WAP 16+35 WTW 2.5-10	1050100000	A.255	WAP WDK10 BL	1186730000	A.283	WDK 10 PE	1415470000	A.283
WAD 16N GE BED	1083600000	A.255	WAP 16+35 WTW 2.5-10	1050100000	A.265	WAP WDK10 BL	1186730000	B.96	WDK 10 SET BCD	1415540000	A.270
WAD 16N GE BED	1083600000	B.26	WAP 16+35 WTW 2.5-10	1050100000	A.289	WAP WDK2.5	1059100000	A.262	WDK 10 SET BCD	1415540000	B.96
WAD 16N GE BED	1083600000	B.264	WAP 16+35 WTW 2.5-10	1050100000	A.290	WAP WDK2.5	1059100000	A.263	WDK 10 SET LS	1415530000	A.271
WAD 20 GE WSD	9512260000	A.256	WAP 16+35 WTW 2.5-10	1050100000	A.291	WAP WDK2.5	1059100000	A.264	WDK 10 SET LS	1415530000	B.96
WAD 20 GE WSD	9512260000	A.257	WAP 16+35 WTW 2.5-10	1050100000	A.292	WAP WDK2.5	1059100000	A.265	WDK 10 V	1186770000	A.268
WAD 20 GE WSD	9512260000	B.27	WAP 16+35 WTW 2.5-10	1050100000	A.293	WAP WDK2.5	1059100000	A.282	WDK 10 V BL	1186780000	A.268
WAD 20 GE WSD	9512260000	B.28	WAP 16+35 WTW 2.5-10	1050100000	A.294	WAP WDK2.5	1059100000	A.327	WDK 10 2.5	1021500000	A.262
WAD 20 GE WSD	9512260000	B.29	WAP 16+35 WTW 2.5-10	1050100000	A.299	WAP WDK2.5	1059100000	A.332	WDK 2.5 1D	8025610000	A.332
WAD 20 GE WSD	9512260000	B.265	WAP 16+35 WTW 2.5-10	1050100000	A.300	WAP WDK2.5	1059100000	A.333	WDK 2.5 1D A.1	1023400000	A.332
WAD 20 GE WSD	9512260000	B.266	WAP 16+35 WTW 2.5-10	1050100000	A.309	WAP WDK2.5	1059100000	A.334	WDK 2.5 1D A.2	1023300000	A.333
WAD 27 M. BL	1062860000	A.261	WAP 16+35 WTW 2.5-10	1050100000	A.311	WAP WDK2.5	1059100000	A.335	WDK 2.5 2D	1023500000	A.334
WAD 27 M. BL	1062860000	B.29	WAP 16+35 WTW 2.5-10	1050100000	A.312	WAP WDK2.5 BL	1059180000	A.262	WDK 2.5 2D 1.A	8014670000	A.333
WAD 27 M. BL	1062860000	B.30	WAP 16+35 WTW 2.5-10	1050100000	A.313	WAP WDK2.5 BL	1059180000	A.263	WDK 2.5 2D 2.A	1022600000	A.334
WAD 27 NEUTRAL	1062960000	A.261	WAP 16+35 WTW 2.5-10	1050100000	A.326	WAP WDK2.5 BL	1059180000	A.264	WDK 2.5 BL	1021580000	A.262
WAD 27 NEUTRAL	1062960000	B.29	WAP 16+35 WTW 2.5-10	1050100000	A.331	WAP WDK2.5 BL	1059180000	A.265	WDK 2.5 FF	1021700000	A.327
WAD 27 NEUTRAL	1062960000	B.30	WAP 16+35 WTW 2.5-10	1050100000	B.26	WAP WDK2.5 BL	1059180000	A.327	WDK 2.5 LD GR 1R 24VDC	8010040000	A.335
WAD 4 GE BED	1072000000	A.241	WAP 16+35 WTW 2.5-10	1050100000	B.27	WAP WDK2.5/4 N	1084000000	A.264	WDK 2.5 LD RT 24VDC +-	1023600000	A.335
WAD 4 GE BED	1072000000	A.243	WAP 16+35 WTW 2.5-10	1050100000	B.194	WAP WDK2.5/4 N	1084000000	A.265	WDK 2.5 LD RT 24VDC +-	1023630000	A.335
WAD 4 GE BED	1072000000	A.244	WAP 16+35 WTW 2.5-10	1050100000	B.262	WAP WDK2.5/4 N	1084000000	A.266	WDK 2.5 LD/GN 1R 24VDC	8023610000	A.335
WAD 4 GE BED	1072000000	A.246	WAP 16+35 WTW 2.5-10	1050100000	B.263	WAP WDK2.5/4 N	1084000000	A.267	WDK 2.5 ZDV	1041180000	A.263
WAD 4 GE BED	1072000000	A.262	WAP 16+35 WTW 2.5-10	1050100000	B.264	WAP WDK2.5/4 N	1084000000	A.282	WDK 2.5 ZDV BL	1041180000	A.263
WAD 4 GE BED	1072000000	A.263	WAP 16+35 WTW 2.5-10 BL	1050180000	A.241	WAP WDK2.5/4 N	1084000000	A.283	WDK 2.5/BLZ/5.08/ZA	1034400000	A.329
WAD 4 GE BED	1072000000	A.264	WAP 16+35 WTW 2.5-10 BL	1050180000	A.242	WAP WDK2.5/4 N BL	1084080000	A.264	WDK 2.5/BLZ/5.08/ZA V	1027410000	A.329
WAD 4 GE BED	1072000000	A.265	WAP 16+35 WTW 2.5-10 BL	1050180000	A.243	WAP WDK2.5/4 N BL	1084080000	A.265	WDK 2.5/D	1023200000	A.335
WAD 4 GE BED	1072000000	A.326	WAP 16+35 WTW 2.5-10 BL	1050180000	A.245	WAP WDK2.5/4 N BL	1084080000	A.266	WDK 2.5/D/3	1023100000	A.333
WAD 4 GE BED	1072000000	A.327	WAP 16+35 WTW 2.5-10 BL	1050180000	A.248	WAP WDK2.5/4 N BL	1084080000	A.267	WDK 2.5/EX	1029100000	A.265
WAD 4 WS	1072100000	A.241	WAP 16+35 WTW 2.5-10 BL	1050180000	A.250	WAP WDK2.5/4 N BL	1084080000	A.282	WDK 2.5/TR-DU	1247290000	A.318
WAD 4 WS	1072100000	A.243	WAP 16+35 WTW 2.5-10 BL	1050180000	A.252	WAP WDK2.5/BLZ/M.ZA	1070100000	A.329	WDK 2.5/TR-DU STB	1247310000	A.318
WAD 4 WS	1072100000	A.244	WAP 16+35 WTW 2.5-10 BL	1050180000	A.253	WAP WDK2.5/BLZ/O.ZA	1070000000	A.329	WDK 2.5/TR-DU/PE	1247420000	A.319
WAD 4 WS	1072100000	A.246	WAP 16+35 WTW 2.5-10 BL	1050180000	A.254	WAP WDL2.5	1067800000	B.302	WDK 2.5/TR-DU/PE STB	1247430000	A.319
WAD 4 WS	1072100000	A.262	WAP 16+35 WTW 2.5-10 BL	1050180000	A.255	WAP WDL2.5	1067800000	B.303	WDK 2.5/TR-DU/PE/O TNHE	1833640000	A.319
WAD 4 WS	1072100000	A.263	WAP 16+35 WTW 2.5-10 BL	1050180000	A.326	WAP WDL2.5/S	1067700000	B.304	WDK 2.5/TR-DU/O TNHE	1833640000	A.318
WAD 4 WS	1072100000	A.264	WAP 16+35 WTW 2.5-10 BL	1050180000	B.26	WAP WDL2.5/S	1067700000	B.305	WDK 2.5/DU-PE	1036400000	A.264
WAD 4 WS	1072100000	A.265	WAP 16+35 WTW 2.5-10 BL	1050180000	B.27	WAP WDT 2.5 AT	1305250000	A.320	WDK 2.5N	1041600000	A.264
WAD 4 WS	1072100000	A.326	WAP 16+35 WTW 2.5-10 BL	1050180000	B.262	WAP WDT 2.5 AT	1305250000	A.321	WDK 2.5N BL	1041680000	A.264
WAD 4 WS	1072100000	A.327	WAP 16+35 WTW 2.5-10 BL	1050180000	B.263	WAP WDT 2.5 BT	1305240000	A.320	WDK 2.5N DU-PE	1041650000	A.265
WAD 5 MC NE GE	1112920000	A.242	WAP 16+35 WTW 2.5-10 BL	1050180000	B.264	WAP WDT 2.5 BT	1305260000	A.321	WDK 2.5N PE	1041620000	A.282
WAD 5 MC NE GE	1112920000	A.243	WAP 2.5-10	1050000000	A.241	WAP WDU/WTR4/ZR	1905070000	A.246	WDK 2.5N V	1041610000	A.265
WAD 5 MC NE GE	1112920000	A.245	WAP 2.5-10	1050000000	A.242	WAP WDU/WTR4/ZR	1905070000	A.275	WDK 2.5PE	1036300000	A.282
WAD 5 MC NE GE	1112920000	B.262	WAP 2.5-10	1050000000	A.243	WAP WDU/WTR4/ZR	1905070000	A.311	WDK 2.5V	1022300000	A.263
WAD 5 MC NE WS	1112910000	A.242	WAP 2.5-10	1050000000	A.245	WAP WDU/WTR4/ZZ	1905150000	A.245	WDK 2.5V BL	1022380000	A.263
WAD 5 MC NE WS	1112910000	A.243	WAP 2.5-10	1050000000	A.247	WAP WDU/WTR4/ZZ	1905150000	A.275	WDK 2.5V ZDV	2739600000	A.263
WAD 5 MC NE WS	1112910000	A.245	WAP 2.5-10	1050000000	A.248	WAP WDU/WTR4/ZZ	1905150000	A.310	WDK 2.5V ZDV BL	10273910000	A.263
WAD 5 MC NE WS	1112910000	B.136	WAP 2.5-10	1050000000	A.249	WAP WDU1.5/BLZ	1577330000	A.328	WDK 2.5V ZDV OR	1023400000	A.263
WAD 5 MC NE WS	1112910000	B.134	WAP 2.5-10	1050000000	A.250	WAP WDU1.5/BLZ/ZA	1577320000	A.328	WDK 4N	1041900000	A.266
WAD 5 MC NE WS	1112910000	B.138	WAP 2.5-10	1050000000	A.251	WAP WDU1.5/R3.5	1754190000	A.240	WDK 4N BL	1041980000	A.266
WAD 5 MC NE WS	1112910000	B.142	WAP 2.5-10	1050000000	A.272	WAP WDU1.5/R3.5	1754190000	A.272	WDK 4N PE	1041920000	A.283
WAD 5 MC NE WS	1112910000	B.262	WAP 2.5-10	1050000000	A.273	WAP WDU2.5N/4N	1060000000	A.243	WDK 4N V	1041910000	A.267
WAD 8 MC B GE/SW	1120470000	A.252	WAP 2.5-10	1050000000	A.285	WAP WDU2.5N/4N	1060000000	A.244	WDL 2.5/L/L	1030300000	B.302
WAD 8 MC NE GE	1112950000	A.248	WAP 2.5-10	1050000000	A.289	WAP WDU2.5N/4N	10				

Type	Order No.	Page	Type	Order No.	Page	Type	Order No.	Page	Type	Order No.	Page
WDU 1.5/ZZ	1031400000	A.241	WDU 70/95 BL	1024680000	B.29	WEW 35/1	1059000000	B.263	WEW 35/2	1061200000	B.80
WDU 1.5/ZZ BL	1031480000	A.241	WDU 70N/35	9512190000	A.257	WEW 35/1	1059000000	B.264	WEW 35/2	1061200000	B.82
WDU 10	1020300000	A.250	WDU 70N/35	9512190000	B.28	WEW 35/1	1059000000	B.265	WEW 35/2	1061200000	B.84
WDU 10 BL	1020380000	A.250	WDU 70N/35 BL	9512420000	A.257	WEW 35/1	1059000000	B.266	WEW 35/2	1061200000	B.86
WDU 10 IR	1393380000	A.250	WDU 70N/35 BL	9512420000	B.28	WEW 35/1	1059000000	B.269	WEW 35/2	1061200000	B.86
WDU 10 SL	9537480000	A.251	WDU 70N/35 GE/SW	2000100000	B.266	WEW 35/1	1059000000	C.13	WEW 35/2	1061200000	B.158
WDU 10 SL/EN	9537490000	A.251	WDU 70N/35 IR	1393420000	A.257	WEW 35/1	1059000000	C.21	WEW 35/2	1061200000	B.160
WDU 10 SL/EN SW	9537410000	A.251	WDU 70N/35 IR	1393420000	B.29	WEW 35/1 GR	1227890000	C.13	WEW 35/2	1061200000	B.161
WDU 10/ZR	1042400000	A.251	WDU 95N/120N	1820550000	A.257	WEW 35/1 GR	1227890000	C.21	WEW 35/2	1061200000	B.162
WDU 10/ZR BL	1042480000	A.251	WDU 95N/120N	1820550000	B.29	WEW 35/1 SW	1162600000	B.218	WEW 35/2	1061200000	B.166
WDU 120/150	1024500000	A.261	WDU 95N/120N BL	1820560000	A.257	WEW 35/1 SW	1162600000	C.13	WEW 35/2	1061200000	B.167
WDU 120/150	1024500000	B.30	WDU 95N/120N BL	1820560000	B.29	WEW 35/1 SW	1162600000	C.21	WEW 35/2	1061200000	B.168
WDU 120/150 BL	1024580000	A.261	WDU 95N/120N GE/SW	2000110000	B.266	WEW 35/2	1061200000	A.241	WEW 35/2	1061200000	B.169
WDU 120/150 BL	1024580000	B.30	WDUB 16	2868370000	A.252	WEW 35/2	1061200000	A.242	WEW 35/2	1061200000	B.172
WDU 16	1020400000	A.252	WDUL 4	8161820000	A.331	WEW 35/2	1061200000	A.243	WEW 35/2	1061200000	B.173
WDU 16 BL	1020480000	A.252	WDUL 4/10	1027000000	A.331	WEW 35/2	1061200000	A.244	WEW 35/2	1061200000	B.174
WDU 16 GE/SW	2000040000	B.263	WDUL 4/100	1027300000	A.331	WEW 35/2	1061200000	A.245	WEW 35/2	1061200000	B.175
WDU 16 IR	1393390000	A.253	WDUL 4/10K	1027700000	A.331	WEW 35/2	1061200000	A.246	WEW 35/2	1061200000	B.176
WDU 16/ZA	1028900000	A.252	WDUL 4/1K	1027500000	A.331	WEW 35/2	1061200000	A.247	WEW 35/2	1061200000	B.177
WDU 16/ZA BL	1028980000	A.252	WDUL 4/500	1027400000	A.331	WEW 35/2	1061200000	A.248	WEW 35/2	1061200000	B.194
WDU 16N	1036100000	A.253	WDUL 4/500K	1028000000	A.331	WEW 35/2	1061200000	A.249	WEW 35/2	1061200000	B.203
WDU 16N BL	1036180000	A.253	WDUL 4/50K	1027800000	A.331	WEW 35/2	1061200000	A.250	WEW 35/2	1061200000	B.204
WDU 16N GE/SW	2000050000	B.263	WDUL 4/5K	1027600000	A.331	WEW 35/2	1061200000	A.251	WEW 35/2	1061200000	B.205
WDU 2.5	1020000000	A.242	WEP 2C 4	2894210000	B.203	WEW 35/2	1061200000	A.252	WEW 35/2	1061200000	B.206
WDU 2.5 BL	1020080000	A.242	WEP 2C 4	2894210000	B.204	WEW 35/2	1061200000	A.253	WEW 35/2	1061200000	B.207
WDU 2.5 F 2X2.8	1021800000	A.326	WEP 2C 4	2894210000	B.205	WEW 35/2	1061200000	A.255	WEW 35/2	1061200000	B.208
WDU 2.5 F 2X2.8	1021900000	A.326	WEP 2C 4	2894210000	B.206	WEW 35/2	1061200000	A.262	WEW 35/2	1061200000	B.209
WDU 2.5 GE/SW	2429520000	B.262	WEP 2C 4	2894210000	B.207	WEW 35/2	1061200000	A.263	WEW 35/2	1061200000	B.210
WDU 2.5 HV	1412950000	A.243	WEP 2C 4	2894210000	B.208	WEW 35/2	1061200000	A.264	WEW 35/2	1061200000	B.211
WDU 2.5/1.5/ZR	1024700000	A.241	WEP 2C 4	2894210000	B.209	WEW 35/2	1061200000	A.265	WEW 35/2	1061200000	B.212
WDU 2.5/1.5/ZR BL	1024780000	A.241	WEP 2C 4	2894210000	B.210	WEW 35/2	1061200000	A.266	WEW 35/2	1061200000	B.213
WDU 2.5/AP/TC BL TYP K	1032880000	B.195	WEP 2C 4	2894210000	B.211	WEW 35/2	1061200000	A.267	WEW 35/2	1061200000	B.214
WDU 2.5/TC TYP B	1033700000	B.194	WEP 2C 4	2894210000	B.212	WEW 35/2	1061200000	A.268	WEW 35/2	1061200000	B.215
WDU 2.5/TC TYP B	1033700000	B.195	WEP 2C 4	2894210000	B.213	WEW 35/2	1061200000	A.269	WEW 35/2	1061200000	B.220
WDU 2.5/TC TYP E	1033300000	B.194	WEP 2C 4	2894210000	B.214	WEW 35/2	1061200000	A.270	WEW 35/2	1061200000	B.222
WDU 2.5/TC TYP E	1033300000	B.195	WEP 2C 4	2894210000	B.215	WEW 35/2	1061200000	A.271	WEW 35/2	1061200000	B.223
WDU 2.5/TC TYP J	1024300000	B.194	WEP 2C 4 BK	2894230000	B.203	WEW 35/2	1061200000	A.272	WEW 35/2	1061200000	B.225
WDU 2.5/TC TYP J	1024300000	B.195	WEP 2C 4 BK	2894230000	B.204	WEW 35/2	1061200000	A.273	WEW 35/2	1061200000	B.262
WDU 2.5/TC TYP K	1024100000	B.194	WEP 2C 4 BK	2894230000	B.205	WEW 35/2	1061200000	A.274	WEW 35/2	1061200000	B.263
WDU 2.5/TC TYP K	1024100000	B.195	WEP 2C 4 BK	2894230000	B.206	WEW 35/2	1061200000	A.275	WEW 35/2	1061200000	B.264
WDU 2.5/TC TYP N	1041500000	B.194	WEP 2C 4 BK	2894230000	B.207	WEW 35/2	1061200000	A.276	WEW 35/2	1061200000	B.298
WDU 2.5/TC TYP N	1041500000	B.195	WEP 2C 4 BK	2894230000	B.208	WEW 35/2	1061200000	A.277	WEW 35/2	1061200000	B.299
WDU 2.5/TC TYP SR	1024400000	B.194	WEP 2C 4 BK	2894230000	B.209	WEW 35/2	1061200000	A.278	WEW 35/2	1061200000	B.300
WDU 2.5/TC TYP SR	1024400000	B.195	WEP 2C 4 BK	2894230000	B.210	WEW 35/2	1061200000	A.279	WEW 35/2	1061200000	B.302
WDU 2.5/TC TYP T	1024200000	B.194	WEP 2C 4 BK	2894230000	B.211	WEW 35/2	1061200000	A.282	WEW 35/2	1061200000	B.303
WDU 2.5/TC TYP T	1024200000	B.195	WEP 2C 4 BK	2894230000	B.212	WEW 35/2	1061200000	A.283	WEW 35/2	1061200000	B.304
WDU 2.5N	1023700000	A.243	WEP 2C 4 BK	2894230000	B.213	WEW 35/2	1061200000	A.284	WEW 35/2	1061200000	B.305
WDU 2.5N BL	1023780000	A.243	WEP 2C 4 BK	2894230000	B.214	WEW 35/2	1061200000	A.285	WEW 35/2	1061200000	C.13
WDU 2.5N ZDV	1040800000	A.243	WEP 2C 4 BK	2894230000	B.215	WEW 35/2	1061200000	A.286	WEW 35/2	1061200000	C.21
WDU 2.5N ZDV BL	1040880000	A.243	WEP 2C 4 BL	2894220000	B.203	WEW 35/2	1061200000	A.287	WEW 35/2 GR	1859200000	B.38
WDU 2.5N/600UL	1730940000	A.244	WEP 2C 4 BL	2894220000	B.204	WEW 35/2	1061200000	A.288	WEW 35/2 GR	1859200000	B.39
WDU 240	1802780000	A.258	WEP 2C 4 BL	2894220000	B.205	WEW 35/2	1061200000	A.289	WEW 35/2 GR	1859200000	B.42
WDU 240	1802780000	B.30	WEP 2C 4 BL	2894220000	B.206	WEW 35/2	1061200000	A.290	WEW 35/2 GR	1859200000	B.43
WDU 240 BL	1822210000	A.258	WEP 2C 4 BL	2894220000	B.207	WEW 35/2	1061200000	A.293	WEW 35/2 GR	1859200000	B.46
WDU 240 BL	1822210000	B.30	WEP 2C 4 BL	2894220000	B.208	WEW 35/2	1061200000	A.294	WEW 35/2 GR	1859200000	B.48
WDU 35	1020500000	A.254	WEP 2C 4 BL	2894220000	B.209	WEW 35/2	1061200000	A.295	WEW 35/2 GR	1859200000	C.13
WDU 35	1020500000	B.26	WEP 2C 4 BL	2894220000	B.210	WEW 35/2	1061200000	A.300	WEW 35/2 GR	1859200000	C.21
WDU 35 BL	1020580000	A.254	WEP 2C 4 BL	2894220000	B.211	WEW 35/2	1061200000	A.308	WEW 35/2 SW	1061210000	A.316
WDU 35 GE/SW	2000060000	B.264	WEP 2C 4 BL	2894220000	B.212	WEW 35/2	1061200000	A.309	WEW 35/2 SW	1061210000	C.13
WDU 35 IR	1393400000	A.254	WEP 2C 4 BL	2894220000	B.213	WEW 35/2	1061200000	A.310	WEW 35/2 SW	1061210000	C.21
WDU 35 IR	1393400000	B.27	WEP 2C 4 BL	2894220000	B.214	WEW 35/2	1061200000	A.311	WEW WTL 35	1925040000	B.178
WDU 35/IK	1020600000	A.255	WEP 2C 4 BL	2894220000	B.215	WEW 35/2	1061200000	A.312	WEW WTL 35	1925040000	B.179
WDU 35/IK	1020600000	B.27	WEW 32/1	1067600000	C.21	WEW 35/2	1061200000	A.313	WF 10	1780870000	A.368
WDU 35/IK BL	1020680000	A.255	WEW 35/1	1059000000	A.252	WEW 35/2	1061200000	A.314	WF 10 NFF	1968950000	A.369
WDU 35/IK/ZA	1029000000	A.255	WEW 35/1	1059000000	A.253	WEW 35/2	1061200000	A.315	WF 10/2BZ	1789790000	A.371
WDU 35/ZA	1028800000	A.254	WEW 35/1	1059000000	A.254	WEW 35/2	1061200000	A.316	WF 12	1780880000	A.369
WDU 35/ZA BL	1028880000	A.254	WEW 35/1	1059000000	A.255	WEW 35/2	1061200000	A.320	WF 12 NFF	1968940000	A.369
WDU 35N	1040400000	A.255	WEW 35/1	1059000000	A.256	WEW 35/2	1061200000	A.321	WF 5	1790130000	A.366
WDU 35N	1040400000	B.26	WEW 35/1	1059000000	A.257	WEW 35/2	1061200000	A.322	WF 5 NFF	1968990000	A.366
WDU 35N BL	1040480000	A.255	WEW 35/1	1059000000	A.258	WEW 35/2	1061200000	A.326	WF 6	1780850000	A.367
WDU 35N GE/SW	2000090000	B.264	WEW 35/1	1059000000	A.261	WEW 35/2	1061200000	A.327	WF 6 NFF	1969000000	A.367
WDU 4	1020100000	A.245	WEW 35/1	1059000000	A.271	WEW 35/2	1061200000	A.328	WF 6/2BZ	1789770000	A.370
WDU 4 BL	1020180000	A.245	WEW 35/1	1059000000	A.277	WEW 35/2	1061200000	A.331	WF 8	1780860000	A.367
WDU 4 GE/SW	1020190000	B.262	WEW 35/1	1059000000	A.278	WEW 35/2	1061200000	A.332	WF 8 NFF	1968960000	A.368
WDU 4 HV	1412960000	A.245	WEW 35/1	1059000000	A.279	WEW 35/2	1061200000	A.333	WF 8/2BZ	1789780000	A.370
WDU 4 SL	9537440000	A.247	WEW 35/1	1059000000	A.280	WEW 35/2	1061200000	A.334	WFF 120	1028500000	A.373
WDU 4 SL BL	9203060000	A.247	WEW 35/1	1059000000	A.281	WEW 35/2	1061200000	A.335	WFF 120 BL	1028580000	A.373
WDU 4 SL/EN	9537450000	A.247	WEW 35/1	1059000000	A.318	WEW 35/2	1061200000	A.366	WFF 120 NFF	1049240000	A.374
WDU 4/ZR	1905140000	A.246	WEW 35/1	1059000000	A.319	WEW 35/2	1061200000	A.367	WFF 120/AH	1029500000	A.373
WDU 4/ZZ	1905060000	A.245	WEW 35/1	1059000000	A.329	WEW 35/2	1061200000	A.368	WFF 185	1028600000	A.374
WDU 4/ZZ BL	1114720000	A.245	WEW 35/1	1059000000	A.372	WEW 35/2	1061200000	A.369	WFF 185 BL	1028680000	A.374
WDU 4N	1042600000	A.246									

Type	Order No.	Page	Type	Order No.	Page	Type	Order No.	Page	Type	Order No.	Page
WFS 4 DB	2562050000	A.284	WPD 103 2X70/2X50 BN	1561820000	B.66	WPD 302 2X35/2X25 3XGY	1561740000	B.62	WQL 2 WFF6-10	1806620000	A.377
WHP 2.5-35N/10X3 BL	1050280000	B.298	WPD 103 2X70/2X50 GN	1561790000	B.66	WPD 304 3X25/6X16+9X10 3XBK	2725400000	B.69	WQL 2 WFF6-8	1808980000	A.377
WHP 2.5-35N/10X3 BL	1050280000	B.299	WPD 103 2X70/2X50 GY	1561770000	B.66	WPD 304 3X25/6X16+9X10 3XBL	2518340000	B.69	WQL 2 WFF8	1780990000	A.367
WHP 2.5-35N/10X3 BL	1050280000	B.300	WPD 104 1X25+1X16/2X16+3X10 BK	2725360000	B.68	WPD 304 3X25/6X16+9X10 3XGY	1562160000	B.69	WQL 2 WFF8	1780990000	A.368
WHP WDL2.5/5 BL	1067980000	B.302	WPD 104 1X25+1X16/2X16+3X10 BL	2518250000	B.68	WPD 304 3X25/6X16+9X10 3XBL	2725300000	B.69	WQL 2 WFF8	1780990000	A.370
WHP WDL2.5/5 BL	1067980000	B.303	WPD 104 1X25+1X16/2X16+3X10 GY	1562000000	B.68	WPD 305 3X35/6X25+9X16 3XBK	2725430000	B.73	WQL 2 WFF8	1780990000	A.378
WHP WDL2.5/5 BL	1067980000	B.304	WPD 104 1X25+1X16/2X16+3X10 RD	2725260000	B.68	WPD 305 3X35/6X25+9X16 3XBL	2521770000	B.73	WQL 2 WFF120	1085100000	A.373
WHP WDL2.5/5 BL	1067980000	B.305	WPD 105 1X35+1X16/2X25+3X16 BK	2725410000	B.72	WPD 305 3X35/6X25+9X16 3XGY	1562190000	B.73	WQL 2 WFF120	1085100000	A.374
WKB 1/10	1604330000	B.171	WPD 105 1X35+1X16/2X25+3X16 BL	2518540000	B.72	WPD 305 3X35/6X25+9X16 3XRD	2725330000	B.73	WQL 2 WFF120	1085100000	A.378
WKB 1/2	1604280000	B.171	WPD 105 1X35+1X16/2X25+3X16 GY	1562170000	B.72	WPD 330 3X50/3X50 1XBN/1XBK/1XGY	2502650000	B.39	WQL 2 WFF185	1085200000	A.374
WKB 1/3	1604300000	B.171	WPD 105 1X35+1X16/2X25+3X16 RD	2725310000	B.72	WPD 330 3X50/3X50 1XGY/1XBL/1XGN	2502640000	B.39	WQL 2 WFF185	1085200000	A.375
WKB 1/4	1604320000	B.164	WPD 106 1X70/2X25+3X16 BK	2725440000	B.76	WPD 330 3X50/3X50 3XGY	2502620000	B.39	WQL 2 WFF185	1085200000	A.378
WKB 1/4	1604320000	B.171	WPD 106 1X70/2X25+3X16 BL	2518570000	B.76	WPD 330CC 3X50/3X50 BK	2874520000	B.39	WQL 2 WFF300	1085300000	A.375
WKS 1/2	1604270000	B.171	WPD 106 1X70/2X25+3X16 GY	1562210000	B.76	WPD 330CC 3X50/3X50 BL	2874530000	B.39	WQL 2 WFF300	1085300000	A.378
WKS 1/2	1604270000	B.176	WPD 106 1X70/2X25+3X16 RD	2725340000	B.76	WPD 330CC 3X50/3X50 BN	2874540000	B.39	WQL 2 WFF35	1064900000	A.372
WKS 1/2	1604270000	B.177	WPD 107 1X95/2X35+8X25 BK	2725450000	B.78	WPD 330CC 3X50/3X50 GN	2874550000	B.39	WQL 2 WFF35	1064900000	A.378
WKS 1/3	1604290000	B.171	WPD 107 1X95/2X35+8X25 BL	2521730000	B.78	WPD 330CC 3X95/3X95 BK	2874510000	B.39	WQL 2 WFF70	1085000000	A.373
WKS 1/3	1604290000	B.177	WPD 107 1X95/2X35+8X25 GY	1562220000	B.78	WPD 331CC 3X95/3X95 GY	2874570000	B.43	WQL 2 WFF70	1085000000	A.378
WKS 1/4	1604310000	B.171	WPD 107 1X95/2X35+8X25 RD	2725350000	B.78	WPD 331CC 3X95/3X95 BL	2874580000	B.43	WQL 3 WF10	1781020000	A.368
WKS 1/4	1604310000	B.177	WPD 108 1X120/2X35+3X25+4X16 BK	2725380000	B.80	WPD 331CC 3X95/3X95 BN	2874590000	B.43	WQL 3 WF10	1781020000	A.369
WKS 2/2	1936140000	B.166	WPD 108 1X120/2X35+3X25+4X16 BL	2519480000	B.80	WPD 331CC 3X95/3X95 GN	2874600000	B.43	WQL 3 WF10	1781020000	A.371
WKS 2/2	1936140000	B.167	WPD 108 1X120/2X35+3X25+4X16 GY	1562100000	B.80	WPD 331CC 3X95/3X95 GY	2874650000	B.43	WQL 3 WF10	1781020000	A.378
WKS 2/2	1936140000	B.168	WPD 108 1X120/2X35+3X25+4X16 RD	2725280000	B.80	WPD 401 2X25/2X16 3XGY/1XBL	1562130000	B.59	WQL 3 WF12	1781040000	A.369
WKS 2/2	1936140000	B.169	WPD 109 1X185/2X35+3X25+4X16 BK	2725370000	B.82	WPD 401 2X25/2X16 4XGY	1561800000	B.59	WQL 3 WF12	1781040000	A.378
WKS 2/2	1936140000	B.171	WPD 109 1X185/2X35+3X25+4X16 BL	2519490000	B.82	WPD 501 2X25/2X16 1XGN/3XGY/1XBL	1562140000	B.59	WQL 3 WF5	1812740000	A.366
WKS 2/3	1936150000	B.167	WPD 109 1X185/2X35+3X25+4X16 GY	1562090000	B.82	WPD 501 2X25/2X16 5XGY	1561750000	B.59	WQL 3 WF5	1812740000	A.378
WKS 2/3	1936150000	B.168	WPD 109 1X185/2X35+3X25+4X16 RD	2725270000	B.82	WPDPC X30 GY	2503330000	B.38	WQL 3 WF6	1780980000	A.367
WKS 2/3	1936150000	B.169	WPD 110 1X70+1X35/6X16 BK	2814510000	B.56	WPDPC X30 GY	2503330000	B.39	WQL 3 WF6	1780980000	A.370
WKS 2/3	1936150000	B.171	WPD 110 1X70+1X35/6X16 BL	2603820000	B.56	WPDPC X31 GY	2503370000	B.42	WQL 3 WF6	1780980000	A.378
WKS 2/3	1936150000	B.172	WPD 110 1X70+1X35/6X16 BN	2814520000	B.56	WPDPC X31 GY	2503370000	B.43	WQL 3 WF6-10/2	1806400000	A.377
WKS 2/3	1936150000	B.174	WPD 110 1X70+1X35/6X16 GN	2603830000	B.56	WPDPC X32 GY	2503380000	B.46	WQL 3 WF8	1781000000	A.367
WKS 2/4	1936160000	B.167	WPD 110 1X70+1X35/6X16 GY	2603810000	B.56	WPDPC X33 GY	2503390000	B.48	WQL 3 WF8	1781000000	A.368
WKS 2/4	1936160000	B.168	WPD 111 1X95/4X35 BK	2730320000	B.84	WPE 1.5/8/3.5	1798460000	A.272	WQL 3 WF8	1781000000	A.370
WKS 2/4	1936160000	B.169	WPD 111 1X95/4X35 BL	2603800000	B.84	WPE 1.5/2Z	1016500000	A.272	WQL 3 WF8	1781000000	A.378
WMF 2.5	1143070000	B.220	WPD 111 1X95/4X35 GY	2603790000	B.84	WPE 10	1010300000	A.277	WQL 3 WF120	1085660000	A.373
WMF 2.5 BL	1270040000	B.220	WPD 111 1X95/4X35 RD	2730310000	B.84	WPE 10/ZR	1042500000	A.277	WQL 3 WFF120	1085600000	A.374
WMF 2.5 BLZ	1143050000	B.223	WPD 113 1X185+1X150/8X35 BK	2730360000	B.86	WPE 120/150	1019700000	A.281	WQL 3 WFF120	1085600000	A.378
WMF 2.5 DI	1143020000	B.220	WPD 113 1X185+1X150/8X35 BL	2603750000	B.86	WPE 120/150	1019700000	B.35	WQL 3 WFF185	1085700000	A.374
WMF 2.5 DI BL	1270070000	B.220	WPD 113 1X185+1X150/8X35 GY	2603740000	B.86	WPE 16	1010400000	A.277	WQL 3 WFF185	1085700000	A.375
WMF 2.5 DI BLZ	1143000000	B.223	WPD 113 1X185+1X150/8X35 RD	2730350000	B.86	WPE 16N	1019100000	A.278	WQL 3 WFF185	1085700000	A.378
WMF 2.5 DI BLZ PE	1143010000	B.224	WPD 130 1X50/1X50 BK	2502570000	B.38	WPE 2.5	1010000000	A.273	WQL 3 WFF300	1085800000	A.375
WMF 2.5 DI PE	1143030000	B.221	WPD 130 1X50/1X50 BL	2502540000	B.38	WPE 2.5 WS	1010010000	B.251	WQL 3 WFF300	1085800000	A.378
WMF 2.5 DI PE BL	1270080000	B.221	WPD 130 1X50/1X50 BN	2502560000	B.38	WPE 2.5 WS	1010010000	B.255	WQL 3 WFF35	1085400000	A.372
WMF 2.5 FU 10-36V SW	1162930000	B.222	WPD 130 1X50/1X50 GN	2502550000	B.38	WPE 2.5/1.5/ZR	1016400000	A.273	WQL 3 WFF35	1085400000	A.378
WMF 2.5 FU 100-250V SW	1162960000	B.222	WPD 130 1X50/1X50 GY	2502530000	B.38	WPE 2.5N	1016200000	A.274	WQL 3 WFF70	1085500000	A.373
WMF 2.5 FU 30-70V SW	1162940000	B.222	WPD 131 1X95/1X95 BK	2502690000	B.42	WPE 35	1010500000	A.278	WQL 3 WFF70	1085500000	A.378
WMF 2.5 FU 60-150V SW	1162950000	B.222	WPD 131 1X95/1X95 BL	2502680000	B.42	WPE 35	1010500000	B.32	WQL 4 WF10	1027840000	A.368
WMF 2.5 FU BLZ 10-36V SW	1162990000	B.225	WPD 131 1X95/1X95 BN	2502680000	B.42	WPE 35/KSC	1012600000	A.279	WQL 4 WF10	1027840000	A.369
WMF 2.5 FU BLZ 100-250V SW	1163020000	B.225	WPD 131 1X95/1X95 GN	2502670000	B.42	WPE 35/KSC	1012600000	B.33	WQL 4 WF10	1027840000	A.378
WMF 2.5 FU BLZ 30-70V SW	1163000000	B.225	WPD 131 1X95/1X95 GY	2503090000	B.42	WPE 35N	1717740000	A.279	WQL 4 WFF6-6/3	1904960000	A.377
WMF 2.5 FU BLZ 60-150V SW	1163010000	B.225	WPD 132 1X185/1X185 BK	2502790000	B.46	WPE 35N	1717740000	B.32	WQS 2/16/5	1925070000	B.178
WMF 2.5 FU BLZ PE 10-36V SW	1162830000	B.225	WPD 132 1X185/1X185 BL	2502760000	B.46	WPE 4	1010100000	A.275	WQS 2/16/5	1925070000	B.179
WMF 2.5 FU BLZ PE 100-250V SW	1162860000	B.225	WPD 132 1X185/1X185 BN	2502780000	B.46	WPE 4/ZR	1905120000	A.275	WQV 10/10	1052460000	A.250
WMF 2.5 FU BLZ PE SW	1162820000	B.225	WPD 132 1X185/1X185 GN	2502770000	B.46	WPE 4/ZZ	1905130000	A.275	WQV 10/10	1052460000	A.251
WMF 2.5 FU BLZ SW	1162890000	B.225	WPD 132 1X185/1X185 GY	2502750000	B.46	WPE 4N	1042700000	A.276	WQV 10/10	1052460000	A.252
WMF 2.5 FU PE 10-36V SW	1163050000	B.222	WPD 133 1X300/1X300 BK	2502890000	B.48	WPE 50N	1846040000	A.279	WQV 10/10	1052460000	A.267
WMF 2.5 FU PE 100-250V SW	1163080000	B.222	WPD 133 1X300/1X300 BL	2502860000	B.48	WPE 50N	1846040000	B.33	WQV 10/10	1052460000	A.268
WMF 2.5 FU PE 30-70V SW	1163060000	B.222	WPD 133 1X300/1X300 BN	2502880000	B.48	WPE 6	1010200000	A.276	WQV 10/10	1052460000	A.269
WMF 2.5 FU PE 60-150V SW	1163070000	B.222	WPD 133 1X300/1X300 GN	2502870000	B.48	WPE 70/95	1037300000	A.281	WQV 10/10	1052460000	A.270
WMF 2.5 FU PE SW	1163040000	B.222	WPD 133 1X300/1X300 GY	2502850000	B.48	WPE 70/95	1037300000	B.34	WQV 10/10	1052460000	A.271
WMF 2.5 FU SW	1162820000	B.222	WPD 201 4X25/4X16 BK	2731260000	B.60	WPE 70N/35	9512200000	A.280	WQV 10/10	1052460000	A.283
WNT 10 10X3	1010980000	B.299	WPD 201 4X25/4X16 BL	2731230000	B.60	WPE 70N/35	9512200000	B.33	WQV 10/10	1052460000	A.349
WNT 10 10X3 BE	1010980000	B.299	WPD 201 4X25/4X16 GN	2731250000	B.60	WPE 95N/120N	1846030000	A.280	WQV 10/10	1052460000	B.96
WNT 16N 10X3	1019000000	B.299	WPD 201 4X25/4X16 RD	2731240000	B.60	WPE 95N/120N	1846030000	B.34	WQV 10/2	1052560000	A.250
WNT 2.5 10X3	1010680000	B.298	WPD 201 4X25/4X16 BK	2731220000	B.60	WPD 4	1036000000	A.330	WQV 10/2	1052560000	A.251
WNT 2.5 10X3 BE	1010680000	B.298	WPD 202 4X35/4X25 GY	1561690000	B.64	WQB 240/2	1802790000	A.258	WQV 10/2	1052560000	A.252
WNT 35N 10X3	1718550000	B.300	WPD 202 4X35/4X25 BL	1561700000	B.64	WQB 240/2	1802790000	B.30	WQV 10/2	1052560000	A.267
WNT 4 10X3	1010780000	B.298	WPD 202 4X35/4X25 BN	1561720000	B.64	WQB 240/3	1802800000	A.258	WQV 10/2	1052560000	A.268
WNT 6 10X3	1010880000	B.299	WPD 202 4X35/4X25 GN	1561620000	B.64	WQB 240/3	1802800000	B.30	WQV 10/2	1052560000	A.269
WNT 70N/35	9512210000	B.300	WPD 202 4X35/4X25 GY	1561730000	B.64	WQB PEN 16N	1079600000	A.357	WQV 10/2	1052560000	A.270
WP 2.5/1AN/1	1305270000	A.320	WPD 204 2X25/4X16+6X10 2XBK	2725390000	B.68	WQB PEN 35N	1079500000	A.357	WQV 10/2	1052560000	A.271
WP 2.5/1AN/1	1305270000	A.321	WPD 204 2X25/4X16+6								

Type	Order No.	Page	Type	Order No.	Page	Type	Order No.	Page	Type	Order No.	Page
WSI 4/LD 60-150V AC/DC	2564370000	A.287	WTL 6 STB BL	2863890000	B.161	WTW WFF120	1067300000	A.374	ZAP ZDU6-2	1771440000	A.219
WSI 6	1011000000	A.289	WTL 6 STB GR	2863910000	B.160	WTW WFF120	1067300000	A.378	ZAP ZDU6-2	1771440000	B.268
WSI 6/2 GF/DEF63	1014000000	A.291	WTL 6 STB BR	2863910000	B.161	WTW WFF185/300	1067400000	A.374	ZAP ZDU6-2 SW	1814710000	A.182
WSI 6/2/LD 30-70V DC/AC	1014100000	A.292	WTL 6 STB SW	2863900000	B.160	WTW WFF185/300	1067400000	A.375	ZAP ZDU6-2 SW	1814710000	A.184
WSI 6/2/LD 10-36V LLC	1119800000	A.294	WTL 6 STB SW	2863900000	B.161	WTW WFF185/300	1067400000	A.378	ZAP ZDU6-2 SW	1814710000	A.186
WSI 6/2/LD 250AC	1014400000	A.292	WTO 6/1	1017900000	B.164	WTW WFF35	1067100000	A.372	ZAP ZDU6-2 SW	1814710000	A.187
WSI 6/2/LD 250AC LLC	1119790000	A.294	WTO 6/1 EN	1934790000	B.168	WTW WFF35	1067100000	A.378	ZAP ZDU6-2 SW	1814710000	A.188
WSI 6/2/LD 30-70V DC/AC	1014200000	A.292	WTO 6/1 EN STB	1934800000	B.168	WTW WFF70	1067200000	A.373	ZAP ZDU6-2 SW	1814710000	A.189
WSI 6/2/LD 30-70V LLC	1119810000	A.294	WTO 6/1/STB	1018100000	B.164	WTW WFF70	1067200000	A.378	ZAP ZDU6-2 SW	1814710000	A.190
WSI 6/2/LD 60-150V LLC	1119820000	A.294	WTR 2.5	1855610000	A.308	WTW WTL 6/1 4MM	1766900000	B.160	ZAP ZDU6-2 SW	1814710000	A.191
WSI 6/2/LD 60-150VDC/AC	1014300000	A.292	WTR 2.5 BL	8731640000	A.308	WTW WTL 6/1 DB	1068400000	B.163	ZAP ZDU6-2 SW	1814710000	A.192
WSI 6/LD 10-36V DC/AC	1011300000	A.290	WTR 2.5 STB.3	1855620000	A.308	WTW WTL6/1 DB	1068400000	B.164	ZAP ZDU6-2 SW	1814710000	A.193
WSI 6/LD 10-36V LLC	1119840000	A.293	WTR 2.5 STB2.3 BL	8731660000	A.308	WTW WTL6/1 DB	1068400000	B.167	ZAP ZDU6-2 SW	1814710000	A.194
WSI 6/LD 250AC	1012400000	A.290	WTR 2.5/O.TNHE	8731700000	A.308	WTW WTL6/1 DB	1068400000	B.168	ZAP ZDU6-2 SW	1814710000	A.195
WSI 6/LD 250AC LLC	1119870000	A.293	WTR 2.5/O.TNHE STB2.3	8731670000	A.308	WTW WTL6/1 DB	1068400000	B.169	ZAP ZDU6-2 SW	1814710000	A.196
WSI 6/LD 30-70V DC/AC	1012200000	A.290	WTR 2.5/SI	1763940000	A.299	WZAD 240	1802810000	A.258	ZAP ZDU6-2 SW	1814710000	A.197
WSI 6/LD 30-70V LLC	1119830000	A.293	WTR 2.5/SI LD 36V	1763950000	A.299	WZAD 240	1802810000	B.30	ZAP ZDU6-2 SW	1814710000	A.198
WSI 6/LD 60-150V DC/AC	1012300000	A.290	WTR 2.5/ZZ	1039900000	A.309	WZAD 50N	1872720000	A.256	ZAP ZDU6-2 SW	1814710000	A.199
WSI 6/LD 60-150V LLC	1119850000	A.293	WTR 2.5/ZZ BL	1039980000	A.309	WZAD 50N	1872720000	B.27	ZAP ZDU6-2 SW	1814710000	A.200
WT 2.5	1305330000	A.320	WTR 2.5/ZZ O.TNHE	1774670000	A.309	WZAD 50N	1872720000	B.28	ZAP ZDU6-2 SW	1814710000	A.201
WT4 4AN/2	1107680000	A.322	WTR 35 E	1045970000	B.269	WZAD 50N	1872720000	B.265	ZAP ZDU6-2 SW	1814710000	A.202
WTA 1 WDU1.5	1632290000	A.243	WTR 4	7910180000	A.309	WZAD 70/95	1066000000	A.261	ZAP ZDU6-2 SW	1814710000	A.203
WTA 1 WDU1.5	1632290000	A.244	WTR 4 BL	7910190000	A.309	WZAD 70/95	1066000000	B.29	ZAP ZDU6-2 SW	1814710000	A.204
WTA 1 WDU1.5	1632290000	A.246	WTR 4 SI SL	7910330000	A.300	WZAD 70N	1964830000	A.257	ZAP ZDU6-2 SW	1814710000	A.205
WTA 1 WDU1.5	1632290000	A.354	WTR 4 SL	7910270000	A.311	WZAD 70N	1964830000	B.28	ZAP ZDU6-2 SW	1814710000	A.206
WTA 1/ZA WDU1.5	1632300000	A.243	WTR 4 SL BL	7910280000	A.311	WZAD 70N	1964830000	B.29	ZAP ZDU6-2 SW	1814710000	A.207
WTA 1/ZA WDU1.5	1632300000	A.244	WTR 4 STB	7910210000	A.309	WZAD 70N	1964830000	B.266	ZAP ZDU6-2 SW	1814710000	A.208
WTA 1/ZA WDU1.5	1632300000	A.246	WTR 4 STB BL	7910220000	A.309	WZAD 95N/120N	1859580000	A.257	ZAP ZDU6-2 SW	1814710000	A.209
WTA 1/ZA WDU1.5	1632300000	A.354	WTR 4 STB SL	7910300000	A.312	WZAD 95N/120N	1859580000	B.29	ZAP ZDU6-2 SW	1814710000	A.210
WTA 2 WDU2.5-10	1632320000	A.241	WTR 4 STB SL BL	7910310000	A.312	WZAD 95N/120N	1859580000	B.268	ZAP ZDU6-2 SW	1814710000	A.211
WTA 2 WDU2.5-10	1632320000	A.242	WTR 4 STB/O.TNHE	2436390000	A.309	WZAD120	1066100000	A.261	ZAP ZDU6-2 SW	1814710000	A.212
WTA 2 WDU2.5-10	1632320000	A.243	WTR 4/O.TNHE	2436380000	A.309	WZAD120	1066100000	B.30	ZAP ZDU6-2 SW	1814710000	A.213
WTA 2 WDU2.5-10	1632320000	A.253	WTR 4/ZR	1905800000	A.311	WZAF 120	1066300000	A.368	ZAP ZDU6-2 SW	1814710000	A.214
WTA 2 WDU2.5-10	1632320000	A.354	WTR 4/ZR STB	1905110000	A.311	WZAF 120	1066300000	A.369	ZAP ZDU6-2 SW	1814710000	A.215
WTA 2 WDU2.5-10	1632320000	B.262	WTR 4/ZR STB/O.TNHE	2436410000	A.311	WZAF 120	1066300000	A.371	ZAP ZDU6-2 SW	1814710000	A.216
WTA 2 WDU2.5-10	1632320000	B.263	WTR 4/ZR/O.TNHE	2436400000	A.311	WZAF 120	1066300000	A.373	ZAP ZDU6-2 SW	1814710000	A.217
WTA 2/10 WDU2.5/10	1632340000	A.354	WTR 4/ZZ	1905800000	A.310	WZAF 120	1066300000	A.374	ZAP ZDU6-2 SW	1814710000	A.218
WTA 2/ZA WDU2.5-10	1632330000	A.241	WTR 4/ZZ BL	1193450000	A.310	WZAF 185	1066400000	A.369	ZAP ZDU6-2 SW	1814710000	A.219
WTA 2/ZA WDU2.5-10	1632330000	A.242	WTR 4/ZZ STB	1905100000	A.310	WZAF 185	1066400000	A.374	ZAP ZDU6-2 SW	1814710000	A.220
WTA 2/ZA WDU2.5-10	1632330000	A.243	WTR 4/ZZ STB BL	1231330000	A.310	WZAF 185	1066400000	A.375	ZAP ZDU6-2 SW	1814710000	A.221
WTA 2/ZA WDU2.5-10	1632330000	A.354	WTR 4/ZZ STB/O.TNHE	2436360000	A.310	WZAF 300	1066500000	A.375	ZAP ZDU6-2 SW	1814710000	A.222
WTA 2/ZA WDU2.5-10	1632330000	B.262	WTR 4/ZZ/O.TNHE	2436420000	A.310	WZAF 35	1070500000	A.367	ZAP ZDU6-2 SW	1814710000	A.223
WTA 3 WDU4	1632350000	A.245	WTR4 SL/EN	7910380000	A.312	WZAF 35	1070500000	A.370	ZAP ZDU6-2 SW	1814710000	A.224
WTA 3 WDU4	1632350000	A.247	WTR4 SL/EN BL	7910370000	A.312	WZAF 35	1070500000	A.372	ZAP ZDU6-2 SW	1814710000	A.225
WTA 3 WDU4	1632350000	A.248	WTR4 SL/EN STB	7910390000	A.313	WZAF 70	1066200000	A.367	ZAP ZDU6-2 SW	1814710000	A.226
WTA 3 WDU4	1632350000	A.250	WTTB 6	2710090000	B.136	WZAF 70	1066200000	A.368	ZAP ZDU6-2 SW	1814710000	A.227
WTA 3 WDU4	1632350000	A.354	WTTB 6	2710090000	B.137	WZAF 70	1066200000	A.370	ZAP ZDU6-2 SW	1814710000	A.228
WTA 3 WDU4	1632350000	B.262	WTTB 6 DL	2792440000	A.102	WZAF 70	1066200000	A.373	ZAP ZDU6-2 SW	1814710000	A.229
WTA 3/ZA WDU4	1632360000	A.245	WTTB 6 PE	2710100000	B.136	ZAD 1/4	1609110000	A.130	ZAP ZDU6-2 SW	1814710000	A.230
WTA 3/ZA WDU4	1632360000	A.354	WTTB 6 PE	2710100000	B.137	ZAD 1/4	1609110000	A.131	ZAP ZDU6-2 SW	1814710000	A.231
WTA 3/ZA WDU4	1632360000	B.262	WTTB 6 PE	2710100000	B.138	ZAD 1/4	1609110000	A.132	ZAP ZDU6-2 SW	1814710000	A.232
WTA 4N WDK 2.5	1878660000	A.355	WTTB 6 PE	2710100000	B.142	ZAD 1/4	1609110000	A.133	ZAP ZDU6-2 SW	1814710000	A.233
WTA 4N/ZA WDK 2.5	1879350000	A.355	WTTB 6 PE	2710100000	B.145	ZAD 1/4	1609110000	A.140	ZAP ZDU6-2 SW	1814710000	A.234
WTA 5/1	1051260000	A.249	WTTB 6 PE DL	2792450000	A.102	ZAD 1/4	1609110000	A.155	ZAP ZDU6-2 SW	1814710000	A.235
WTA 5/1	1051260000	A.250	WTW EN	1058800000	A.253	ZAD 1/4	1609110000	A.156	ZAP ZDU6-2 SW	1814710000	A.236
WTA 5/1	1051260000	A.355	WTW EN	1058800000	A.255	ZAD 1/4	1609110000	A.157	ZAP ZDU6-2 SW	1814710000	A.237
WTA 5/10	1062060000	A.355	WTW EN	1058800000	A.262	ZAD 1/4-2 GE	1764560000	A.138	ZAP ZDU6-2 SW	1814710000	A.238
WTA 6 WTR2.5	1632380000	A.308	WTW EN	1058800000	A.263	ZAD 1/4-2 GE	1764560000	A.139	ZAP ZDU6-2 SW	1814710000	A.239
WTA 6 WTR2.5	1632380000	A.354	WTW EN	1058800000	A.264	ZAD 1/4-2 GE	1764560000	A.152	ZAP ZDU6-2 SW	1814710000	A.240
WTA 6/ZA WTR2.5	1632390000	A.354	WTW EN	1058800000	A.265	ZAD 1/4-2 GE	1764560000	A.153	ZAP ZDU6-2 SW	1814710000	A.241
WTA 7 WSI6	1650210000	A.354	WTW EN	1058800000	A.266	ZAD 1/4-2 GE	1764560000	A.154	ZAP ZDU6-2 SW	1814710000	A.242
WTA 8 KO-TN	1915480000	A.355	WTW EN	1058800000	A.267	ZAD 2/4	1609080000	A.132	ZAP ZDU6-2 SW	1814710000	A.243
WTA 8 TN	1915450000	A.355	WTW EN	1058800000	A.282	ZAD 2/4	1609080000	A.133	ZAP ZDU6-2 SW	1814710000	A.244
WTA 8 TN	1915450000	B.158	WTW EN	1058800000	A.297	ZAD 2/4	1609080000	A.141	ZAP ZDU6-2 SW	1814710000	A.245
WTD 6 SL	9538090000	B.173	WTW EN	1058800000	A.298	ZAD 3/4	1609120000	A.129	ZAP ZDU6-2 SW	1814710000	A.246
WTD 6 SL O.STB	1238920000	B.172	WTW EN	1058800000	A.327	ZAD 3/4	1609120000	A.133	ZAP ZDU6-2 SW	1814710000	A.247
WTD 6 SL O.STB	1238920000	B.173	WTW EN	1058800000	B.26	ZAD 4/5	1746730000	A.134	ZAP ZDU6-2 SW	1814710000	A.248
WTD 6 SL/EN	9538100000	B.174	WTW EN	1058800000	B.173	ZAD 5/5	1745210000	A.135	ZAP ZDU6-2 SW	1814710000	A.249
WTD 6 SL/EN	9538100000	B.175	WTW EN	1058800000	B.175	ZAD 6/5	1752620000	A.136	ZAP ZDU6-2 SW	1814710000	A.250
WTD 6/1	1017100000	B.162	WTW EN	1058800000	B.263	ZAD 7/4	1781940000	A.128	ZAP ZDU6-2 SW	1814710000	A.251
WTD 6/1	1017100000	B.163	WTW EN	1058800000	B.264	ZAD 7/4	1781940000	A.129	ZAP ZDU6-2 SW	1814710000	A.252
WTD 6/1 EN	1934830000	B.166	WTW WFF10/WFF12	1780890000	A.368	ZAD 7/4	1781940000	A.144	ZAP ZDU6-2 SW	1814710000	A.253
WTD 6/1 EN	1934830000	B.167	WTW WFF10/WFF12	1780890000	A.369	ZAD 7/4	1781940000	A.145	ZAP ZDU6-2 SW	1814710000	A.254
WTL 35/1STB	1925060000	B.179	WTW WFF10/WFF12	1780890000	A.370	ZAD 9/4	1934160000	A.142	ZAP ZDU6-2 SW	1814710000	A.255
WTL 35/1STB/AVQV	1925050000	B.179	WTW WFF10/WFF12	1780890000	A.371	ZAD 9/4	1934160000	A.143	ZAP ZDU6-2 SW	1814710000	A.256
WTL 35/2STB	1925030000	B.179	WTW WFF10/WFF12	1780890000	A.378	ZAD 9/4	1934160000	A.158	ZAP ZDU6-2 SW	1814710000	A.257
WTL 4	1754960000	B.158	WTW WFF10/WFF12 2300	1780920000	A.368	ZAD 9/4	1934160000	A.159	ZAP ZDU6-2 SW	1814710000	A.258
WTL 4/2 STB	1881650000	B.158	WTW WFF10/WFF12 2300	1780920000	A.369	ZAD 9/4	1934160000	A.174	ZAP ZDU6-2 SW	1814710000	A.259
WTL 4/STB	1754970000	B.158	WTW WFF10/WFF12 2300	1780920000	A.371	ZAD 9/4	1934160000	A.175	ZAP ZDU6-2 SW	1814710000	A.260
WTL 6 SL	1161690000	B.173	WTW WFF10/WFF12 2300	1780920000	A.378	ZAD ZT/ZPS2.5	1861030000	A.213	ZAP ZDU6-2 SW	1814710000	A.261
WTL 6 SL O.STB	1238930000	B.172									

Type	Order No.	Page	Type	Order No.	Page	Type	Order No.	Page	Type	Order No.	Page
ZAP/TW ZDU1.5/3AN	1776060000	A.128	ZDK 2.5/D/5	1690050000	A.222	ZDU 6-2/3AN BL	1771420000	A.141	ZEW 35	9540000000	B.95
ZAP/TW ZDU1.5/3AN	1776060000	A.161	ZDK 2.5/D/6	1690060000	A.222	ZDU 6/3AN	7907410000	A.133	ZEW 35	9540000000	B.156
ZAP/TW ZDU1.5/3AN BL	1776070000	A.128	ZDK 2.5/D/9	2738140000	A.223	ZDU 6/3AN BL	7907420000	A.133	ZEW 35	9540000000	B.254
ZAP/TW ZDU1.5/4AN	1776090000	A.129	ZDK 2.5/LD RT/1	1690010000	A.220	ZDUA 2.5-2	1720920000	A.125	ZEW 35	9540000000	B.268
ZAP/TW ZDU1.5/4AN	1776090000	A.162	ZDK 2.5/LD RT/2	1693940000	A.220	ZDUA 2.5-2 BL	1720930000	A.125	ZEW 35	9540000000	C.21
ZAP/TW ZDU1.5/4AN BL	1776100000	A.129	ZDK 2.5DU-PE	1689970000	A.147	ZDUA 2.5-2 OR	1720940000	A.125	ZEW 35 GR	1238040000	C.21
ZAP/TW ZDU10	1748660000	A.134	ZDK 2.5N-DU	1689960000	A.147	ZDUA 2.5-2N	1808200000	A.125	ZEW 35/2	8630740000	A.150
ZAP/TW ZDU10	1748660000	A.166	ZDK 2.5N-PE	1689980000	A.147	ZDUB 2.5-2/2AN/15	1712750000	A.124	ZEW 35/2	8630740000	A.176
ZAP/TW ZDU10 BL	1764110000	A.134	ZDK 2.5PE	1690000000	A.174	ZDUB 2.5-2/2AN/15 BL	1712760000	A.124	ZEW 35/2	8630740000	B.115
ZAP/TW ZDU16	1745150000	A.135	ZDK 2.5V	1689990000	A.146	ZDUB 2.5-2/2AN/15 OR	1712770000	A.124	ZEW 35/2	8630740000	C.21
ZAP/TW ZDU16	1745150000	A.167	ZDK 2.5V BL	1745880000	A.146	ZDUB 2.5-2/2AN/DB	1704500000	A.123	ZEW 35/2 GR	1227850000	C.21
ZAP/TW ZDU16 BL	1764100000	A.135	ZDK 4-2	8670750000	A.155	ZDUB 2.5-2/2AN/DB GE	1704530000	A.123	ZEW 35/2 SW	1162610000	B.216
ZAP/TW ZDUA	1720960000	A.125	ZDK 4-2 BL	8670850000	A.155	ZDUB 2.5-2/2AN/DM	1704350000	A.123	ZEW 35/2 SW	1162610000	B.217
ZAP/TW ZDUA	1720960000	A.160	ZDK 4-2 EL	8708976000	A.223	ZDUB 2.5-2/2AN/DM BL	1704360000	A.123	ZEW 35/2 SW	1162610000	B.219
ZAP/TW ZDUA BL	1720970000	A.125	ZDK 4-2 PE	8671050000	A.175	ZDUB 2.5-2/2AN/DM GE	1704380000	A.123	ZEW 35/2 SW	1162610000	C.21
ZAP/TW ZDUA OR	1720980000	A.125	ZDK 4-2 V	8671080000	A.155	ZDUB 2.5-2/2AN/DM OR	1704370000	A.123	ZGB 30	1611930000	A.209
ZAP/TW ZDUA2 5-2N	1808170000	A.125	ZDK 4-2/2AN	1119700000	A.157	ZDUB 2.5-2/2AN/RC	1712820000	A.122	ZGB 30	1611930000	A.328
ZAP/TW ZDUA2 5-2N	1808170000	A.160	ZDK 4-2/D FORWARD	8670520000	A.223	ZDUB 2.5-2/2AN/RC BL	1712830000	A.122	ZIA 1.5/3L-1S	1651980000	B.188
ZAP/TW ZIA1.5/3L	1649540000	B.188	ZDK 4-2/DU-PE	8671120000	A.156	ZDUB 2.5-2/4AN/15	1712780000	A.124	ZIA 1.5/3L-1S/LDRT	1651990000	B.188
ZAP/TW ZIA1.5/4L	1649550000	B.188	ZDKPE 2.5-2	1805940000	A.154	ZDUB 2.5-2/4AN/15 BL	1712790000	A.124	ZIA 1.5/3L-PE	1652000000	B.188
ZAP/TW ZPV1.5	1674650000	B.189	ZDKPE 2.5-2/N/L/PE	1895700000	A.154	ZDUB 2.5-2/4AN/15 OR	1712800000	A.124	ZIA 1.5/4L-1S	1652010000	B.189
ZAP/TW ZT2.5/2AN	1816030000	A.196	ZDLD 2.5-2N	1782300000	A.148	ZDUB 2.5-2/4AN/DB	1704690000	A.123	ZIA 1.5/4L-1S/LD	1652020000	B.189
ZAP/TW ZT2.5/2AN	1816030000	A.199	ZDLD 2.5-2N BL	1782310000	A.148	ZDUB 2.5-2/4AN/DB BL	1704700000	A.123	ZIA 1.5/4L-PE	1652030000	B.189
ZAP/TW ZT2.5/2AN OR	1816040000	A.196	ZDLD 2.5-2N PE	1131740000	A.149	ZDUB 2.5-2/4AN/DB GE	1704720000	A.123	ZMAK 2.5	1768000000	A.151
ZAP/TW ZT2.5/2AN OR	1816040000	A.199	ZDLD 2.5-2N/PE/L/L	1131750000	A.149	ZDUB 2.5-2/4AN/DM	1704540000	A.123	ZMAK 2.5	1768000000	B.95
ZAP/TW ZT2.5/3AN	1816050000	A.196	ZDLD 2.5-2N/PE/L/N	1131760000	A.149	ZDUB 2.5-2/4AN/DM BL	1704550000	A.123	ZMAK 2.5 690V	1027550000	A.151
ZAP/TW ZT2.5/3AN	1816050000	A.199	ZDLD 2.5-2VN	1782320000	A.148	ZDUB 2.5-2/4AN/DM GE	1704570000	A.123	ZMAK 2.5 690V	1027550000	B.95
ZAP/TW ZT2.5/4AN/2	1816070000	A.197	ZDLD 2.5-2VN BL	1782330000	A.148	ZDUB 2.5-2/4AN/DM OR	1704560000	A.123	ZP 2.5/1AN	1875150000	A.212
ZAP/TW ZT2.5/4AN/2	1816070000	A.200	ZDT 2.5/2	1815150000	A.202	ZDUB 2.5-2/4AN/RC	1712970000	A.122	ZP 2.5/1AN GN	1875180000	A.212
ZAP/TW ZT2.5/4AN/2 OR	1816080000	A.197	ZDT 2.5/2 BL	1348970000	A.202	ZDUB 2.5-2/4AN/RC BL	1712980000	A.122	ZP 2.5/1AN ZA	1875190000	A.212
ZAP/TW ZT2.5/4AN/2 OR	1816080000	A.200	ZDT 2.5/2 DU-PE	1815160000	A.203	ZDUB 2.5-2/4AN/RC GE	1713000000	A.122	ZP 2.5/1AN ZA BL	1009070000	A.212
ZAP/TW ZT2.5/4AN/4	1816090000	A.197	ZDT 2.5/2 PE	1815170000	A.204	ZEI 16	1745350000	A.135	ZP 2.5/1AN ZA GN	1875200000	A.212
ZAP/TW ZT2.5/4AN/4	1816090000	A.200	ZDT 2.5/2 V	1084770000	A.202	ZEI 16 BL	1766240000	A.135	ZP 2.5/1AN ZA O.RA	1875210000	A.212
ZAP/TW ZT4/2AN	1855220000	A.198	ZDTR 2.5	1745400000	A.194	ZEI 16-2/1AN	1772940000	A.141	ZP 2.5/1AN ZA O.RA BL	1972980000	A.212
ZAP/TW ZT4/2AN	1855220000	A.201	ZDTR 2.5 BL	1798330000	A.194	ZEI 16-2/1AN BL	1772950000	A.141	ZP 2.5/1AN ZA O.RA GN	1875220000	A.212
ZAP/TW ZT4/2AN OR	1855230000	A.198	ZDU 1.5	1775490000	A.128	ZEI 6	1791190000	A.129	ZP 2.5/1AN/1	1815430000	A.197
ZAP/TW ZT4/2AN OR	1855230000	A.201	ZDU 1.5 BL	1775490000	A.128	ZEW 15	7920340000	A.124	ZP 2.5/1AN/1 BL	1009060000	A.212
ZAP/TW ZT4/4AN/2	1848360000	A.198	ZDU 1.5/2X2AN	1826970000	A.129	ZEW 15	7920340000	A.125	ZP 2.5/1AN/1 GN	1815430000	A.208
ZAP/TW ZT4/4AN/2	1848360000	A.201	ZDU 1.5/3AN	1775530000	A.128	ZEW 15	7920340000	A.160	ZP 2.5/1AN/1 GN BL	1820580000	A.208
ZAP/TW ZTR2.5	1865520000	A.205	ZDU 1.5/3AN BL	1775540000	A.128	ZEW 15	7920340000	A.161	ZP 2.5/1AN/10	1815560000	A.197
ZAP/TW4/4AN	7904210000	A.133	ZDU 1.5/4AN	1775580000	A.129	ZEW 15	7920340000	C.21	ZP 2.5/1AN/10	1815560000	A.208
ZAP/TW4/4AN	7904210000	A.164	ZDU 1.5/4AN BL	1775600000	A.129	ZEW 35	9540000000	A.128	ZP 2.5/1AN/10 GN/BE	1867170000	A.208
ZAP/TW4/4AN BL	7904220000	A.133	ZDU 10	1746750000	A.134	ZEW 35	9540000000	A.129	ZP 2.5/1AN/11	1815570000	A.208
ZAP/TW6/3AN	7907370000	A.133	ZDU 10 BL	1746760000	A.134	ZEW 35	9540000000	A.130	ZP 2.5/1AN/11 GN/BE	1867180000	A.208
ZAP/TW6/3AN	7907370000	A.165	ZDU 10/3AN	1767690000	A.134	ZEW 35	9540000000	A.131	ZP 2.5/1AN/12	1815580000	A.208
ZAP/TW6/3AN BL	7907380000	A.133	ZDU 10/3AN BL	1767700000	A.134	ZEW 35	9540000000	A.132	ZP 2.5/1AN/12 GN/BE	1867190000	A.208
ZAP/TW7	1706110000	A.138	ZDU 16	1745230000	A.135	ZEW 35	9540000000	A.133	ZP 2.5/1AN/13	1815590000	A.208
ZAP/TW7	1706110000	A.139	ZDU 16 BL	1745240000	A.135	ZEW 35	9540000000	A.134	ZP 2.5/1AN/13 GN/BE	1867200000	A.208
ZAP/TW7	1706110000	A.168	ZDU 16/3AN	1768320000	A.135	ZEW 35	9540000000	A.135	ZP 2.5/1AN/14	1815600000	A.208
ZAP/TW7	1706110000	A.169	ZDU 16/3AN BL	1768330000	A.135	ZEW 35	9540000000	A.136	ZP 2.5/1AN/14 GN/BE	1867210000	A.208
ZAP/TW7	1706110000	A.193	ZDU 2.5	1608510000	A.130	ZEW 35	9540000000	A.138	ZP 2.5/1AN/15	1815610000	A.208
ZAP/TW7	1706110000	A.218	ZDU 2.5 BL	1608520000	A.130	ZEW 35	9540000000	A.139	ZP 2.5/1AN/15 GN/BE	1867220000	A.208
ZAP/TW7	1706110000	A.219	ZDU 2.5-2	1772060000	A.138	ZEW 35	9540000000	A.140	ZP 2.5/1AN/16	1815620000	A.208
ZAP/TW7 BL	1706120000	A.138	ZDU 2.5-2 BL	1772070000	A.138	ZEW 35	9540000000	A.141	ZP 2.5/1AN/17	1815180000	A.208
ZAP/TW7 BL	1706120000	A.139	ZDU 2.5-2 O.EL	1868870000	A.218	ZEW 35	9540000000	A.142	ZP 2.5/1AN/17 GN/BE	1867240000	A.208
ZAP/Z...16-2/1AN	1772970000	A.141	ZDU 2.5-2/3AN	1706010000	A.138	ZEW 35	9540000000	A.143	ZP 2.5/1AN/2	1815440000	A.197
ZAP/Z...16-2/1AN	1772970000	A.171	ZDU 2.5-2/3AN BL	1706040000	A.138	ZEW 35	9540000000	A.144	ZP 2.5/1AN/2	1815440000	A.208
ZB 16 ZKSC	0316600000	B.298	ZDU 2.5-2/4AN	1706060000	A.139	ZEW 35	9540000000	A.145	ZP 2.5/1AN/2 GN/BE	1867090000	A.208
ZB 16 ZKSC	0316600000	B.299	ZDU 2.5-2/4AN BL	1706070000	A.139	ZEW 35	9540000000	A.146	ZP 2.5/1AN/3	1815450000	A.197
ZB 16 ZKSC	0316600000	B.300	ZDU 2.5-2/D+	1779110000	A.218	ZEW 35	9540000000	A.147	ZP 2.5/1AN/3	1815450000	A.208
ZB 16 ZKSC	0316600000	B.304	ZDU 2.5-2/D	1779000000	A.219	ZEW 35	9540000000	A.148	ZP 2.5/1AN/3 GN/BE	1867100000	A.208
ZB 16 ZKSC	0316600000	B.305	ZDU 2.5/2X2AN	1608600000	A.131	ZEW 35	9540000000	A.149	ZP 2.5/1AN/4	1815500000	A.197
ZB 35/MX16	0266500000	B.298	ZDU 2.5/2X2AN BL	1608610000	A.131	ZEW 35	9540000000	A.151	ZP 2.5/1AN/4	1815500000	A.208
ZB 35/MX16	0266500000	B.299	ZDU 2.5/2X2AN/D+	1650340000	A.217	ZEW 35	9540000000	A.152	ZP 2.5/1AN/4 GN/BE	1867110000	A.208
ZB 35/MX16	0266500000	B.300	ZDU 2.5/2X2AN/D-	1650350000	A.217	ZEW 35	9540000000	A.153	ZP 2.5/1AN/5	1815510000	A.197
ZB 35/MX16	0266500000	B.304	ZDU 2.5/2X2AN/LD+	1692590000	A.216	ZEW 35	9540000000	A.154	ZP 2.5/1AN/5	1815510000	A.208
ZB 35/MX16	0266500000	B.305	ZDU 2.5/2X2AN/LD-	1692600000	A.216	ZEW 35	9540000000	A.155	ZP 2.5/1AN/5 GN/BE	1867120000	A.208
ZB 4	0316500000	B.298	ZDU 2.5/3AN	1608540000	A.130	ZEW 35	9540000000	A.156	ZP 2.5/1AN/6	1815520000	A.197
ZB 4	0316500000	B.299	ZDU 2.5/3AN BL	1608550000	A.130	ZEW 35	9540000000	A.157	ZP 2.5/1AN/6	1815520000	A.208
ZB 4	0316500000	B.300	ZDU 2.5/4AN	1608570000	A.131	ZEW 35	9540000000	A.158	ZP 2.5/1AN/6 GN/BE	1867130000	A.208
ZB 4	0316500000	B.304	ZDU 2.5/4AN BL	1608580000	A.131	ZEW 35	9540000000	A.159	ZP 2.5/1AN/7	1815530000	A.197
ZB 4	0316500000	B.305	ZDU 2.5N	1933700000	A.142	ZEW 35	9540000000	A.161	ZP 2.5/1AN/7	1815530000	A.208
ZBB ZDUB	1704740000	A.123	ZDU 2.5N BL	1933710000	A.142	ZEW 35	9540000000	A.162	ZP 2.5/1AN/7 GN/BE	1867140000	A.208
ZDK 1.5	1791100000	A.144	ZDU 2.5N/3AN	1933720000	A.142	ZEW 35	9540000000	A.163	ZP 2.5/1AN/8	1815540000	A.197
ZDK 1.5 BL	1791100000	A.144	ZDU 2.5N/3AN BL	1933730000	A.142	ZEW 35	9540000000	A.164	ZP 2.5/1AN/8	1815540000	A.208
ZDK 1.5DU-PE	1791120000	A.145	ZDU 2.5N/4AN	1933740000	A.143	ZEW 35	9540000000	A.165	ZP 2.5/1AN/8 GN/BE	1867150000	A.208
ZDK 1.5PE	1791150000	A.174	ZDU 2.5N/4AN BL	1933750000	A.143	ZEW 35	9540000000	A.166	ZP 2.5/1AN/9	1815550000	A.197
ZDK 1.5V	1791130000	A.144	ZDU 3.5	1739620000	A.136	ZEW 35	9540000000	A.167	ZP 2.5/1AN/9	1815550000	A.208
ZDK 1.5V BL	1791140000	A.144	ZDU 3.5 BL	1739630000	A.136	ZEW 35	9540000000	A.168	ZP 2.5/1AN/9 GN/BE	1867160000	A.208
ZDK 2.											

Type	Order No.	Page	Type	Order No.	Page	Type	Order No.	Page	Type	Order No.	Page
ZP 2.5/1AN/QV/13	1815310000	A.209	ZPE 1.5/4AN	1775620000	A.162	ZQV 1.5N/10 RD	1985800000	B.103	ZQV 2.5/10	1608940000	A.148
ZP 2.5/1AN/QV/14	1815200000	A.209	ZPE 10	1746770000	A.166	ZQV 1.5N/10 RD	1985800000	B.104	ZQV 2.5/10	1608940000	A.149
ZP 2.5/1AN/QV/15	1815300000	A.209	ZPE 10/3AN	1767670000	A.166	ZQV 1.5N/10 RD	1985800000	B.105	ZQV 2.5/10	1608940000	A.150
ZP 2.5/1AN/QV/16	1815340000	A.209	ZPE 16	1746250000	A.167	ZQV 1.5N/10 RD	1985800000	B.106	ZQV 2.5/10	1608940000	A.152
ZP 2.5/1AN/QV/17	1815350000	A.209	ZPE 16-2/1AN	1772960000	A.171	ZQV 1.5N/10 RD	1985800000	B.107	ZQV 2.5/10	1608940000	A.153
ZP 2.5/1AN/QV/2	1815200000	A.196	ZPE 16/3AN	1768310000	A.167	ZQV 1.5N/10 RD	1985800000	B.184	ZQV 2.5/10	1608940000	A.154
ZP 2.5/1AN/QV/2	1815200000	A.197	ZPE 2.5	1608640000	A.162	ZQV 1.5N/10 RD	1985800000	B.185	ZQV 2.5/10	1608940000	A.158
ZP 2.5/1AN/QV/2	1815200000	A.202	ZPE 2.5-2	1772090000	A.168	ZQV 1.5N/2	1985410000	A.16	ZQV 2.5/10	1608940000	A.159
ZP 2.5/1AN/QV/2	1815200000	A.203	ZPE 2.5-2/3AN	1706090000	A.168	ZQV 1.5N/2	1985410000	A.17	ZQV 2.5/10	1608940000	A.192
ZP 2.5/1AN/QV/2	1815200000	A.209	ZPE 2.5-2/4AN	1706100000	A.169	ZQV 1.5N/2	1985410000	A.24	ZQV 2.5/10	1608940000	A.193
ZP 2.5/1AN/QV/3	1815210000	A.196	ZPE 2.5/3AN	1608650000	A.163	ZQV 1.5N/2	1985410000	A.27	ZQV 2.5/10	1608940000	A.206
ZP 2.5/1AN/QV/3	1815210000	A.197	ZPE 2.5/4AN	1608660000	A.163	ZQV 1.5N/2	1985410000	A.32	ZQV 2.5/10	1608940000	A.207
ZP 2.5/1AN/QV/3	1815210000	A.202	ZPE 2.5/4AN WS	1698110000	B.251	ZQV 1.5N/2	1985410000	A.33	ZQV 2.5/10	1608940000	A.218
ZP 2.5/1AN/QV/3	1815210000	A.203	ZPE 2.5/4AN WS	1698110000	B.254	ZQV 1.5N/2	1985410000	A.40	ZQV 2.5/10	1608940000	A.219
ZP 2.5/1AN/QV/3	1815210000	A.209	ZPE 2.5N	1933760000	A.172	ZQV 1.5N/2	1985410000	A.41	ZQV 2.5/10	1608940000	A.220
ZP 2.5/1AN/QV/4	1815220000	A.196	ZPE 2.5N/3AN	1933770000	A.172	ZQV 1.5N/2	1985410000	A.72	ZQV 2.5/10	1608940000	A.221
ZP 2.5/1AN/QV/4	1815220000	A.197	ZPE 2.5N/4AN	1933780000	A.173	ZQV 1.5N/2	1985410000	A.73	ZQV 2.5/10	1608940000	A.222
ZP 2.5/1AN/QV/4	1815220000	A.202	ZPE 35	1739650000	A.167	ZQV 1.5N/2	1985410000	A.74	ZQV 2.5/10	1608940000	A.223
ZP 2.5/1AN/QV/4	1815220000	A.203	ZPE 4	1632080000	A.163	ZQV 1.5N/2	1985410000	A.75	ZQV 2.5/10	1608940000	A.224
ZP 2.5/1AN/QV/4	1815220000	A.209	ZPE 4-2/2AN	1770380000	A.169	ZQV 1.5N/2	1985410000	A.110	ZQV 2.5/10	1608940000	A.230
ZP 2.5/1AN/QV/5	1815230000	A.196	ZPE 4-2/3AN	1770390000	A.169	ZQV 1.5N/2	1985410000	A.262	ZQV 2.5/10	1608940000	B.188
ZP 2.5/1AN/QV/5	1815230000	A.197	ZPE 4-2/4AN	1807090000	A.170	ZQV 1.5N/2	1985410000	B.52	ZQV 2.5/10	1608940000	B.189
ZP 2.5/1AN/QV/5	1815230000	A.202	ZPE 4/3AN	7904170000	A.164	ZQV 1.5N/2	1985410000	B.297	ZQV 2.5/2	1608860000	A.130
ZP 2.5/1AN/QV/5	1815230000	A.203	ZPE 4/4AN	7904280000	A.164	ZQV 1.5N/2 BL	1985530000	A.110	ZQV 2.5/2	1608860000	A.131
ZP 2.5/1AN/QV/5	1815230000	A.209	ZPE 6	1608670000	A.165	ZQV 1.5N/2 BL	1985530000	B.102	ZQV 2.5/2	1608860000	A.135
ZP 2.5/1AN/QV/6	1815240000	A.196	ZPE 6-2/2AN	1771370000	A.170	ZQV 1.5N/2 BL	1985530000	B.103	ZQV 2.5/2	1608860000	A.138
ZP 2.5/1AN/QV/6	1815240000	A.197	ZPE 6-2/3AN	1771380000	A.171	ZQV 1.5N/2 BL	1985530000	B.104	ZQV 2.5/2	1608860000	A.141
ZP 2.5/1AN/QV/6	1815240000	A.202	ZPE 6/3AN	7907400000	A.165	ZQV 1.5N/2 BL	1985530000	B.105	ZQV 2.5/2	1608860000	A.142
ZP 2.5/1AN/QV/6	1815240000	A.203	ZPEA 2.5-2	1720950000	A.160	ZQV 1.5N/2 BL	1985530000	B.184	ZQV 2.5/2	1608860000	A.143
ZP 2.5/1AN/QV/6	1815240000	A.209	ZPEA 2.5-2N	1808210000	A.160	ZQV 1.5N/2 BL	1985530000	B.185	ZQV 2.5/2	1608860000	A.146
ZP 2.5/1AN/QV/7	1815250000	A.196	ZPEB 2.5-2	1712810000	A.161	ZQV 1.5N/2 RD	1985650000	A.110	ZQV 2.5/2	1608860000	A.147
ZP 2.5/1AN/QV/7	1815250000	A.197	ZPS 2.5/1AN/QV/1	1865880000	A.209	ZQV 1.5N/2 RD	1985650000	B.102	ZQV 2.5/2	1608860000	A.148
ZP 2.5/1AN/QV/7	1815250000	A.202	ZPS 2.5/1AN/QV/1	1861040000	A.213	ZQV 1.5N/2 RD	1985650000	B.103	ZQV 2.5/2	1608860000	A.149
ZP 2.5/1AN/QV/7	1815250000	A.203	ZPS 2.5/1AN/QV/1 GN	1861050000	A.213	ZQV 1.5N/2 RD	1985650000	B.104	ZQV 2.5/2	1608860000	A.150
ZP 2.5/1AN/QV/7	1815250000	A.209	ZPS 2.5/1AN/QV/10	1865980000	A.209	ZQV 1.5N/2 RD	1985650000	B.105	ZQV 2.5/2	1608860000	A.152
ZP 2.5/1AN/QV/8	1815260000	A.196	ZPS 2.5/1AN/QV/12	1866000000	A.209	ZQV 1.5N/2 RD	1985650000	B.106	ZQV 2.5/2	1608860000	A.153
ZP 2.5/1AN/QV/8	1815260000	A.197	ZPS 2.5/1AN/QV/14	1866020000	A.209	ZQV 1.5N/2 RD	1985650000	B.107	ZQV 2.5/2	1608860000	A.154
ZP 2.5/1AN/QV/8	1815260000	A.202	ZPS 2.5/1AN/QV/15	1866030000	A.209	ZQV 1.5N/2 RD	1985650000	B.184	ZQV 2.5/2	1608860000	A.158
ZP 2.5/1AN/QV/8	1815260000	A.203	ZPS 2.5/1AN/QV/16	1866040000	A.209	ZQV 1.5N/2 RD	1985650000	B.185	ZQV 2.5/2	1608860000	A.159
ZP 2.5/1AN/QV/8	1815260000	A.209	ZPS 2.5/1AN/QV/2	1865900000	A.209	ZQV 1.5N/20	1985600000	A.110	ZQV 2.5/2	1608860000	A.192
ZP 2.5/1AN/QV/9	1815270000	A.196	ZPS 2.5/1AN/QV/3	1865910000	A.209	ZQV 1.5N/20 BL	1985700000	A.110	ZQV 2.5/2	1608860000	A.193
ZP 2.5/1AN/QV/9	1815270000	A.197	ZPS 2.5/1AN/QV/4	1865920000	A.209	ZQV 1.5N/20 RD	1985810000	A.110	ZQV 2.5/2	1608860000	A.206
ZP 2.5/1AN/QV/9	1815270000	A.202	ZPS 2.5/1AN/QV/5	1865930000	A.209	ZQV 1.5N/3	1985480000	A.110	ZQV 2.5/2	1608860000	A.207
ZP 2.5/1AN/QV/9	1815270000	A.203	ZPS 2.5/1AN/QV/6	1865940000	A.209	ZQV 1.5N/3 BL	1985550000	A.110	ZQV 2.5/2	1608860000	A.218
ZP 2.5/1AN/QV/9	1815270000	A.209	ZPS 2.5/1AN/QV/7	1865950000	A.209	ZQV 1.5N/3 RD	1985670000	A.110	ZQV 2.5/2	1608860000	A.219
ZP 2.5/2AN/QV	1007810000	A.212	ZPS 2.5/1AN/QV/8	1865960000	A.209	ZQV 1.5N/4	1985490000	A.110	ZQV 2.5/2	1608860000	A.220
ZP 2.5/2AN/QV GN	1007830000	A.212	ZPS 2.5/1AN/QV/9	1865970000	A.209	ZQV 1.5N/4 BL	1985570000	A.110	ZQV 2.5/2	1608860000	A.221
ZP 2.5/2AN/QV ZA O.RA	1007870000	A.212	ZPV 1.5	1676630000	B.188	ZQV 1.5N/4 RD	1985690000	A.110	ZQV 2.5/2	1608860000	A.222
ZP 2.5/2AN/QV ZAD.RA BL	1007880000	A.212	ZQB 2.5-2	1677120000	A.122	ZQV 1.5N/5	1985500000	A.110	ZQV 2.5/2	1608860000	A.223
ZP 2.5/2AN/QV/1	1815730000	A.209	ZQB 2.5-2	1677120000	A.123	ZQV 1.5N/5 BL	1985590000	A.110	ZQV 2.5/2	1608860000	A.224
ZP 2.5/2AN/QV/1 GN	1820590000	A.209	ZQB 2.5-2	1677120000	A.124	ZQV 1.5N/5 RD	1985710000	A.110	ZQV 2.5/2	1608860000	A.230
ZP 2.5/2AN/QV/10	1815820000	A.209	ZQB 2.5-2	1677120000	A.139	ZQV 1.5N/50	1985620000	A.110	ZQV 2.5/2	1608860000	B.188
ZP 2.5/2AN/QV/11	1815830000	A.209	ZQB 2.5-2	1677120000	A.230	ZQV 1.5N/50 BL	1985720000	A.110	ZQV 2.5/2	1608860000	B.189
ZP 2.5/2AN/QV/12	1815840000	A.209	ZQS 2.5/2	1633200000	A.180	ZQV 1.5N/50 RD	1985820000	A.110	ZQV 2.5/20	1908960000	A.230
ZP 2.5/2AN/QV/15	1815870000	A.209	ZQS 2.5/2	1633200000	A.181	ZQV 1.5N/6	1985510000	A.110	ZQV 2.5/3	1608870000	A.230
ZP 2.5/2AN/QV/16	1815880000	A.209	ZQS 2.5/2	1633200000	A.230	ZQV 1.5N/6 BL	1985610000	A.110	ZQV 2.5/3	1608870000	B.188
ZP 2.5/2AN/QV/2	1815740000	A.209	ZQS 2.5/3	1633210000	A.230	ZQV 1.5N/6 RD	1985730000	A.110	ZQV 2.5/3	1608870000	B.189
ZP 2.5/2AN/QV/3	1815750000	A.209	ZQS 2.5/4	1633220000	A.180	ZQV 1.5N/7	1985520000	A.110	ZQV 2.5/4	1608880000	A.230
ZP 2.5/2AN/QV/4	1815760000	A.209	ZQS 2.5/4	1633220000	A.181	ZQV 1.5N/7 BL	1985630000	A.110	ZQV 2.5/4	1608880000	B.188
ZP 2.5/2AN/QV/5	1815770000	A.209	ZQS 2.5/4	1633220000	A.230	ZQV 1.5N/7 RD	1985750000	A.110	ZQV 2.5/4	1608880000	B.189
ZP 2.5/2AN/QV/6	1815780000	A.209	ZQS 2.5/5	1633230000	A.230	ZQV 1.5N/8	1985540000	A.110	ZQV 2.5/5	1608890000	A.230
ZP 2.5/2AN/QV/7	1815790000	A.209	ZQV 1.5/10	1776200000	A.128	ZQV 1.5N/8 BL	1985640000	A.110	ZQV 2.5/50	1697540000	B.188
ZP 2.5/2AN/QV/8	1815800000	A.209	ZQV 1.5/10	1776200000	A.129	ZQV 1.5N/8 RD	1985770000	A.110	ZQV 2.5/50	1697540000	B.189
ZP 2.5/2AN/QV/9	1815810000	A.209	ZQV 1.5/10	1776200000	A.144	ZQV 1.5N/9	1985560000	A.110	ZQV 2.5/6	1608900000	A.230
ZP 4/1AN	1051970000	A.212	ZQV 1.5/10	1776200000	A.145	ZQV 1.5N/9 BL	1985660000	A.110	ZQV 2.5/7	1608910000	A.230
ZP 4/1AN GN	1051980000	A.212	ZQV 1.5/10	1776200000	A.230	ZQV 1.5N/9 RD	1985790000	A.110	ZQV 2.5/8	1608920000	A.230
ZP 4/1AN ZA	1051940000	A.212	ZQV 1.5/2	1776120000	A.128	ZQV 1.5N/R3.5/10 GE	1754290000	A.240	ZQV 2.5/9	1608930000	A.230
ZP 4/1AN ZA BL	1366790000	A.212	ZQV 1.5/2	1776120000	A.129	ZQV 1.5N/R3.5/2 GE	1754210000	A.240	ZQV 2.5N/10	1527690000	A.6
ZP 4/1AN ZA GN	1051950000	A.212	ZQV 1.5/2	1776120000	A.144	ZQV 10/2	1739680000	A.134	ZQV 2.5N/10	1527690000	A.7
ZP 4/1AN ZA O.RA	1051910000	A.212	ZQV 1.5/2	1776120000	A.145	ZQV 10/2	1739680000	A.231	ZQV 2.5N/10	1527690000	A.8
ZP 4/1AN ZA O.RA BL	2449680000	A.212	ZQV 1.5/2	1776120000	A.230	ZQV 10N/2	2497250000	A.25	ZQV 2.5N/10	1527690000	A.9
ZP 4/1AN ZA O.RA GN	1051920000	A.212	ZQV 1.5/3	1776130000	A.230	ZQV 10N/2	2497250000	A.111	ZQV 2.5N/10	1527690000	A.17
ZP 4/1AN/1	1848340000	A.198	ZQV 1.5/4	1776140000	A.230	ZQV 10N/2	2497250000	B.279	ZQV 2.5N/10	1527690000	A.18
ZP 4/1AN/1	1848340000	A.210	ZQV 1.5/5	1776150000	A.230	ZQV 10N/2	2497250000	B.283	ZQV 2.5N/10	1527690000	A.19
ZP 4/1AN/1 GN	1854980000	A.210	ZQV 1.5N/10	1985580000	A.16	ZQV 150/185N/2	2728840000	A.30	ZQV 2.5N/10	1527690000	A.24
ZP 4/1AN/10	1855070000	A.198	ZQV 1.5N/10	1985580000	A.17	ZQV 150/185N/2	2728840000	A.31	ZQV 2.5N/10	1527690000	A.27
ZP 4/1AN/10	1855070000	A.210	ZQV 1.5N/10	1985580000	A.24	ZQV 150/185N/2	2728840000	A.112	ZQV 2.5N/10		

Type	Order No.	Page	Type	Order No.	Page	Type	Order No.	Page	Type	Order No.	Page
ZQV 2.5N/10	1527690000	A.125	ZQV 2.5N/2	1527540000	A.209	ZQV 2.5N/4 RD	2108700000	A.110	ZQV 4/2 GE	1608950000	A.132
ZQV 2.5N/10	1527690000	A.194	ZQV 2.5N/2	1527540000	A.241	ZQV 2.5N/4 RD	2108700000	A.344	ZQV 4/2 GE	1608950000	A.133
ZQV 2.5N/10	1527690000	A.196	ZQV 2.5N/2	1527540000	A.242	ZQV 2.5N/4 WT	2831580000	A.113	ZQV 4/2 GE	1608950000	A.139
ZQV 2.5N/10	1527690000	A.197	ZQV 2.5N/2	1527540000	A.243	ZQV 2.5N/4 WT	2831580000	A.345	ZQV 4/2 GE	1608950000	A.140
ZQV 2.5N/10	1527690000	A.202	ZQV 2.5N/2	1527540000	A.263	ZQV 2.5N/5	1527620000	A.110	ZQV 4/2 GE	1608950000	A.155
ZQV 2.5N/10	1527690000	A.203	ZQV 2.5N/2	1527540000	A.264	ZQV 2.5N/5	1527620000	A.344	ZQV 4/2 GE	1608950000	A.156
ZQV 2.5N/10	1527690000	A.205	ZQV 2.5N/2	1527540000	A.265	ZQV 2.5N/5 BK	2831700000	A.113	ZQV 4/2 GE	1608950000	A.182
ZQV 2.5N/10	1527690000	A.209	ZQV 2.5N/2	1527540000	A.299	ZQV 2.5N/5 BK	2831700000	A.345	ZQV 4/2 GE	1608950000	A.184
ZQV 2.5N/10	1527690000	A.241	ZQV 2.5N/2	1527540000	A.308	ZQV 2.5N/5 BL	1527790000	A.110	ZQV 4/2 GE	1608950000	A.186
ZQV 2.5N/10	1527690000	A.242	ZQV 2.5N/2	1527540000	A.309	ZQV 2.5N/5 RD	1527790000	A.344	ZQV 4/2 GE	1608950000	A.187
ZQV 2.5N/10	1527690000	A.243	ZQV 2.5N/2	1527540000	A.320	ZQV 2.5N/5 RD	2108710000	A.110	ZQV 4/2 GE	1608950000	A.198
ZQV 2.5N/10	1527690000	A.263	ZQV 2.5N/2	1527540000	A.321	ZQV 2.5N/5 RD	2108710000	A.344	ZQV 4/2 GE	1608950000	A.223
ZQV 2.5N/10	1527690000	A.264	ZQV 2.5N/2	1527540000	A.328	ZQV 2.5N/5 WT	2831590000	A.113	ZQV 4/2 GE	1608950000	A.230
ZQV 2.5N/10	1527690000	A.265	ZQV 2.5N/2	1527540000	A.344	ZQV 2.5N/5 WT	2831590000	A.345	ZQV 4/20 GE	1909010000	A.230
ZQV 2.5N/10	1527690000	A.299	ZQV 2.5N/2	1527540000	B.52	ZQV 2.5N/50	1527730000	A.110	ZQV 4/3 GE	1608960000	A.230
ZQV 2.5N/10	1527690000	A.308	ZQV 2.5N/2	1527540000	B.94	ZQV 2.5N/50	1527730000	A.344	ZQV 4/4 GE	1608970000	A.230
ZQV 2.5N/10	1527690000	A.309	ZQV 2.5N/2	1527540000	B.220	ZQV 2.5N/50 BK	2831770000	A.113	ZQV 4/5 GE	1608980000	A.230
ZQV 2.5N/10	1527690000	A.320	ZQV 2.5N/2	1527540000	B.221	ZQV 2.5N/50 BK	2831770000	A.345	ZQV 4/6 GE	1608990000	A.230
ZQV 2.5N/10	1527690000	A.321	ZQV 2.5N/2	1527540000	B.222	ZQV 2.5N/50 BL	1527920000	A.110	ZQV 4/7 GE	1609000000	A.230
ZQV 2.5N/10	1527690000	A.328	ZQV 2.5N/2	1527540000	B.223	ZQV 2.5N/50 BL	1527920000	A.344	ZQV 4/8 GE	1609010000	A.230
ZQV 2.5N/10	1527690000	A.344	ZQV 2.5N/2	1527540000	B.224	ZQV 2.5N/50 RD	2109000000	A.110	ZQV 4/9 GE	1609020000	A.230
ZQV 2.5N/10	1527690000	B.52	ZQV 2.5N/2	1527540000	B.225	ZQV 2.5N/50 RD	2109000000	A.344	ZQV 4N/10	1528090000	A.7
ZQV 2.5N/10	1527690000	B.94	ZQV 2.5N/2	1527540000	B.256	ZQV 2.5N/50 WT	2831660000	A.113	ZQV 4N/10	1528090000	A.8
ZQV 2.5N/10	1527690000	B.220	ZQV 2.5N/2	1527540000	B.257	ZQV 2.5N/50 WT	2831660000	A.345	ZQV 4N/10	1528090000	A.19
ZQV 2.5N/10	1527690000	B.221	ZQV 2.5N/2	1527540000	B.262	ZQV 2.5N/6	1527630000	A.110	ZQV 4N/10	1528090000	A.20
ZQV 2.5N/10	1527690000	B.222	ZQV 2.5N/2	1527540000	B.278	ZQV 2.5N/6	1527630000	A.344	ZQV 4N/10	1528090000	A.21
ZQV 2.5N/10	1527690000	B.223	ZQV 2.5N/2	1527540000	B.284	ZQV 2.5N/6 BK	2831710000	A.113	ZQV 4N/10	1528090000	A.27
ZQV 2.5N/10	1527690000	B.224	ZQV 2.5N/2	1527540000	B.285	ZQV 2.5N/6 BK	2831710000	A.345	ZQV 4N/10	1528090000	A.38
ZQV 2.5N/10	1527690000	B.225	ZQV 2.5N/2	1527540000	B.286	ZQV 2.5N/6 BL	1527820000	A.110	ZQV 4N/10	1528090000	A.39
ZQV 2.5N/10	1527690000	B.256	ZQV 2.5N/2	1527540000	B.287	ZQV 2.5N/6 BL	1527820000	A.344	ZQV 4N/10	1528090000	A.61
ZQV 2.5N/10	1527690000	B.257	ZQV 2.5N/2	1527540000	B.290	ZQV 2.5N/6 RD	2108720000	A.110	ZQV 4N/10	1528090000	A.62
ZQV 2.5N/10	1527690000	B.262	ZQV 2.5N/2	1527540000	B.291	ZQV 2.5N/6 RD	2108720000	A.344	ZQV 4N/10	1528090000	A.63
ZQV 2.5N/10	1527690000	B.278	ZQV 2.5N/2	1527540000	B.292	ZQV 2.5N/6 WT	2831600000	A.113	ZQV 4N/10	1528090000	A.64
ZQV 2.5N/10	1527690000	B.284	ZQV 2.5N/2	1527540000	B.293	ZQV 2.5N/6 WT	2831600000	A.345	ZQV 4N/10	1528090000	A.69
ZQV 2.5N/10	1527690000	B.285	ZQV 2.5N/2 BK	2831670000	A.113	ZQV 2.5N/7	1527640000	A.110	ZQV 4N/10	1528090000	A.71
ZQV 2.5N/10	1527690000	B.286	ZQV 2.5N/2 BK	2831670000	A.345	ZQV 2.5N/7	1527640000	A.344	ZQV 4N/10	1528090000	A.80
ZQV 2.5N/10	1527690000	B.287	ZQV 2.5N/2 BL	1527740000	A.110	ZQV 2.5N/7 BK	2831720000	A.113	ZQV 4N/10	1528090000	A.81
ZQV 2.5N/10	1527690000	B.287	ZQV 2.5N/2 BL	1527740000	A.344	ZQV 2.5N/7 BK	2831720000	A.345	ZQV 4N/10	1528090000	A.82
ZQV 2.5N/10	1527690000	B.290	ZQV 2.5N/2 BL	1527740000	B.108	ZQV 2.5N/7 BL	1527830000	A.110	ZQV 4N/10	1528090000	A.83
ZQV 2.5N/10	1527690000	B.291	ZQV 2.5N/2 BL	1527740000	B.109	ZQV 2.5N/7 BL	1527830000	A.344	ZQV 4N/10	1528090000	A.110
ZQV 2.5N/10	1527690000	B.292	ZQV 2.5N/2 BL	1527740000	B.110	ZQV 2.5N/7 RD	2108810000	A.110	ZQV 4N/10	1528090000	A.245
ZQV 2.5N/10	1527690000	B.293	ZQV 2.5N/2 BL	1527740000	B.111	ZQV 2.5N/7 RD	2108810000	A.344	ZQV 4N/10	1528090000	A.246
ZQV 2.5N/10 BK	2831750000	A.113	ZQV 2.5N/2 BL	1527740000	B.282	ZQV 2.5N/7 WT	2831610000	A.113	ZQV 4N/10	1528090000	A.247
ZQV 2.5N/10 BK	2831750000	A.345	ZQV 2.5N/2 RD	2108470000	A.110	ZQV 2.5N/7 WT	2831610000	A.345	ZQV 4N/10	1528090000	A.266
ZQV 2.5N/10 BL	1527880000	A.110	ZQV 2.5N/2 RD	2108470000	A.344	ZQV 2.5N/8	1527670000	A.110	ZQV 4N/10	1528090000	A.267
ZQV 2.5N/10 BL	1527880000	A.344	ZQV 2.5N/2 RD	2108470000	B.108	ZQV 2.5N/8	1527670000	A.344	ZQV 4N/10	1528090000	A.300
ZQV 2.5N/10 BL	1527880000	B.108	ZQV 2.5N/2 RD	2108470000	B.109	ZQV 2.5N/8 BK	2831730000	A.113	ZQV 4N/10	1528090000	A.309
ZQV 2.5N/10 BL	1527880000	B.109	ZQV 2.5N/2 RD	2108470000	B.108	ZQV 2.5N/8 BK	2831730000	A.345	ZQV 4N/10	1528090000	A.310
ZQV 2.5N/10 BL	1527880000	B.110	ZQV 2.5N/2 RD	2108470000	B.111	ZQV 2.5N/8 BL	1527840000	A.110	ZQV 4N/10	1528090000	A.311
ZQV 2.5N/10 BL	1527880000	B.111	ZQV 2.5N/2 RD	2108470000	B.112	ZQV 2.5N/8 BL	1527840000	A.344	ZQV 4N/10	1528090000	A.312
ZQV 2.5N/10 BL	1527880000	B.282	ZQV 2.5N/2 RD	2108470000	B.113	ZQV 2.5N/8 RD	2108870000	A.110	ZQV 4N/10	1528090000	A.313
ZQV 2.5N/10 RD	2108910000	A.110	ZQV 2.5N/2 WT	2831560000	A.113	ZQV 2.5N/8 RD	2108870000	A.344	ZQV 4N/10	1528090000	A.322
ZQV 2.5N/10 RD	2108910000	A.344	ZQV 2.5N/2 WT	2831560000	A.345	ZQV 2.5N/8 WT	2831620000	A.113	ZQV 4N/10	1528090000	A.344
ZQV 2.5N/10 RD	2108910000	B.108	ZQV 2.5N/20	1527720000	A.110	ZQV 2.5N/8 WT	2831620000	A.345	ZQV 4N/10	1528090000	B.52
ZQV 2.5N/10 RD	2108910000	B.109	ZQV 2.5N/20	1527720000	A.344	ZQV 2.5N/9	1527680000	A.110	ZQV 4N/10	1528090000	B.203
ZQV 2.5N/10 RD	2108910000	B.110	ZQV 2.5N/20 BK	2831760000	A.113	ZQV 2.5N/9	1527680000	A.344	ZQV 4N/10	1528090000	B.204
ZQV 2.5N/10 RD	2108910000	B.111	ZQV 2.5N/20 BK	2831760000	A.345	ZQV 2.5N/9 BK	2831740000	A.113	ZQV 4N/10	1528090000	B.205
ZQV 2.5N/10 RD	2108910000	B.112	ZQV 2.5N/20 BL	1527890000	A.110	ZQV 2.5N/9 BK	2831740000	A.345	ZQV 4N/10	1528090000	B.206
ZQV 2.5N/10 RD	2108910000	B.113	ZQV 2.5N/20 BL	1527890000	A.344	ZQV 2.5N/9 BL	1527870000	A.110	ZQV 4N/10	1528090000	B.207
ZQV 2.5N/10 WT	2831640000	A.113	ZQV 2.5N/20 RD	2108920000	A.110	ZQV 2.5N/9 BL	1527870000	A.344	ZQV 4N/10	1528090000	B.208
ZQV 2.5N/10 WT	2831640000	A.345	ZQV 2.5N/20 RD	2108920000	A.344	ZQV 2.5N/9 RD	2108900000	A.110	ZQV 4N/10	1528090000	B.209
ZQV 2.5N/2	1527540000	A.6	ZQV 2.5N/20 WT	2831650000	A.113	ZQV 2.5N/9 RD	2108900000	A.344	ZQV 4N/10	1528090000	B.210
ZQV 2.5N/2	1527540000	A.7	ZQV 2.5N/20 WT	2831650000	A.345	ZQV 2.5N/9 WT	2831630000	A.113	ZQV 4N/10	1528090000	B.211
ZQV 2.5N/2	1527540000	A.8	ZQV 2.5N/3	1527570000	A.110	ZQV 2.5N/9 WT	2831630000	A.345	ZQV 4N/10	1528090000	B.212
ZQV 2.5N/2	1527540000	A.9	ZQV 2.5N/3	1527570000	A.344	ZQV 35-10	7920100000	A.230	ZQV 4N/10	1528090000	B.213
ZQV 2.5N/2	1527540000	A.17	ZQV 2.5N/3	1527570000	B.278	ZQV 35/2	1739700000	A.136	ZQV 4N/10	1528090000	B.214
ZQV 2.5N/2	1527540000	A.18	ZQV 2.5N/3	1527570000	B.284	ZQV 35/2	1739700000	A.231	ZQV 4N/10	1528090000	B.215
ZQV 2.5N/2	1527540000	A.19	ZQV 2.5N/3	1527570000	B.285	ZQV 35N-10	2562670000	A.28	ZQV 4N/10	1528090000	B.257
ZQV 2.5N/2	1527540000	A.24	ZQV 2.5N/3	1527570000	B.286	ZQV 35N-10	2562670000	A.111	ZQV 4N/10	1528090000	B.258
ZQV 2.5N/2	1527540000	A.27	ZQV 2.5N/3	1527570000	B.287	ZQV 35N-10	2562670000	B.8	ZQV 4N/10	1528090000	B.262
ZQV 2.5N/2	1527540000	A.34	ZQV 2.5N/3	1527570000	B.290	ZQV 35N-10	2562670000	8.9	ZQV 4N/10	1528090000	B.288
ZQV 2.5N/2	1527540000	A.35	ZQV 2.5N/3	1527570000	B.291	ZQV 35N-10	2562670000	B.10	ZQV 4N/10	1528090000	B.289
ZQV 2.5N/2	1527540000	A.36	ZQV 2.5N/3	1527570000	B.292	ZQV 35N-10	2562670000	B.11	ZQV 4N/10	1528090000	B.298
ZQV 2.5N/2	1527540000	A.37	ZQV 2.5N/3	1527570000	B.293	ZQV 35N-10	2562670000	B.12	ZQV 4N/10 BK	2810830000	A.113
ZQV 2.5N/2	1527540000	A.42	ZQV 2.5N/3 BK	2831680000	A.113	ZQV 35N-10	2562670000	B.259	ZQV 4N/10 BK	2810830000	A.345
ZQV 2.5N/2	1527540000	A.43	ZQV 2.5N/3 BK	2831680000	A.345	ZQV 35N-16	2562660000	A.28	ZQV 4N/10 BL	1528230000	A.110
ZQV 2.5N/2	1527540000	A.44	ZQV 2.5N/3 BL	1527770000	A.110	ZQV 35N-16	2562660000	A.111	ZQV 4N/10 BL	1528230000	A.344
ZQV 2.5N/2	1527540000	A.60	ZQV 2.5N/3 BL	1527770000	A.344	ZQV 35N-16	2562660000				

Type	Order No.	Page	Type	Order No.	Page	Type	Order No.	Page	Type	Order No.	Page
ZDV 4N/2	1527930000	A.62	ZDV 4N/41 RD	2883840000	A.344	ZDV 6N/10	2733970000	B.145	ZRH 1.5H/2	1678800000	A.169
ZDV 4N/2	1527930000	A.63	ZDV 4N/5	1527980000	A.110	ZDV 6N/10 BL	2786910000	A.111	ZRH 1.5H/2	1678800000	A.172
ZDV 4N/2	1527930000	A.64	ZDV 4N/5	1527980000	A.344	ZDV 6N/2	1985740000	A.22	ZRH 1.5H/2	1678800000	A.173
ZDV 4N/2	1527930000	A.69	ZDV 4N/5 BK	2810900000	A.113	ZDV 6N/2	1985740000	A.23	ZRH 1.5H/2	1678800000	A.174
ZDV 4N/2	1527930000	A.71	ZDV 4N/5 BK	2810900000	A.345	ZDV 6N/2	1985740000	A.27	ZRH 1.5H/2	1678800000	A.175
ZDV 4N/2	1527930000	A.80	ZDV 4N/5 BL	1528140000	A.110	ZDV 6N/2	1985740000	A.111	ZRH 1.5H/2	1678800000	A.176
ZDV 4N/2	1527930000	A.81	ZDV 4N/5 BL	1528140000	A.344	ZDV 6N/2	1985740000	B.52	ZRH 1.5H/2	1678800000	A.235
ZDV 4N/2	1527930000	A.82	ZDV 4N/5 RD	2460790000	A.110	ZDV 6N/2	1985740000	B.258	ZRH 1.5H/2	1678800000	B.95
ZDV 4N/2	1527930000	A.83	ZDV 4N/5 RD	2460790000	A.344	ZDV 6N/2	1985740000	B.278	ZRH 1.5N/1	1632140000	A.235
ZDV 4N/2	1527930000	A.110	ZDV 4N/5 WT	2831830000	A.113	ZDV 6N/2 BL	1985830000	A.111	ZRH 1.5N/1	1632140000	B.188
ZDV 4N/2	1527930000	A.245	ZDV 4N/5 WT	2831830000	A.345	ZDV 6N/2 BL	1985830000	B.282	ZRH 1.5N/1	1632140000	B.189
ZDV 4N/2	1527930000	A.246	ZDV 4N/50	1528130000	A.110	ZDV 6N/20	2810820000	A.111	ZRH 1.5N/2	1632130000	A.235
ZDV 4N/2	1527930000	A.247	ZDV 4N/50	1528130000	A.344	ZDV 6N/3	1985760000	A.22	ZRH 1.5N/2	1632130000	B.188
ZDV 4N/2	1527930000	A.266	ZDV 4N/50 BL	1528240000	A.110	ZDV 6N/3	1985760000	A.23	ZRH 1.5N/2	1632130000	B.189
ZDV 4N/2	1527930000	A.267	ZDV 4N/50 BL	1528240000	A.344	ZDV 6N/3	1985760000	A.111	ZRH 1.5S/1	1781950000	A.128
ZDV 4N/2	1527930000	A.300	ZDV 4N/50 RD	2460730000	A.110	ZDV 6N/3	1985760000	B.258	ZRH 1.5S/1	1781950000	A.129
ZDV 4N/2	1527930000	A.309	ZDV 4N/50 RD	2460730000	A.344	ZDV 6N/3 BL	1985840000	A.111	ZRH 1.5S/1	1781950000	A.144
ZDV 4N/2	1527930000	A.310	ZDV 4N/6	1527990000	A.110	ZDV 6N/4	1985780000	A.22	ZRH 1.5S/1	1781950000	A.145
ZDV 4N/2	1527930000	A.311	ZDV 4N/6	1527990000	A.344	ZDV 6N/4	1985780000	A.23	ZRH 1.5S/1	1781950000	A.161
ZDV 4N/2	1527930000	A.312	ZDV 4N/6 BK	2810910000	A.113	ZDV 6N/4	1985780000	A.111	ZRH 1.5S/1	1781950000	A.162
ZDV 4N/2	1527930000	A.313	ZDV 4N/6 BK	2810910000	A.345	ZDV 6N/4	1985780000	B.52	ZRH 1.5S/1	1781950000	A.174
ZDV 4N/2	1527930000	A.322	ZDV 4N/6 BL	1528170000	A.110	ZDV 6N/4	1985780000	B.145	ZRH 1.5S/1	1781950000	A.235
ZDV 4N/2	1527930000	A.344	ZDV 4N/6 BL	1528170000	A.344	ZDV 6N/4	1985780000	B.258	ZRH 2.5/1 WS	1614300000	A.130
ZDV 4N/2	1527930000	B.52	ZDV 4N/6 RD	2460780000	A.110	ZDV 6N/4 BL	1985850000	A.111	ZRH 2.5/1 WS	1614300000	A.131
ZDV 4N/2	1527930000	B.203	ZDV 4N/6 RD	2460780000	A.344	ZDV 6N/6	2733950000	A.111	ZRH 2.5/1 WS	1614300000	A.162
ZDV 4N/2	1527930000	B.204	ZDV 4N/6 WT	2831840000	A.113	ZDV 6N/6	2733950000	B.134	ZRH 2.5/1 WS	1614300000	A.163
ZDV 4N/2	1527930000	B.205	ZDV 4N/6 WT	2831840000	A.345	ZDV 6N/6	2733950000	B.136	ZRH 2.5/1 WS	1614300000	A.216
ZDV 4N/2	1527930000	B.206	ZDV 4N/7	1528020000	A.110	ZDV 6N/6	2733950000	B.136	ZRH 2.5/1 WS	1614300000	A.217
ZDV 4N/2	1527930000	B.207	ZDV 4N/7	1528020000	A.344	ZDV 6N/6	2733950000	B.137	ZRH 2.5/1 WS	1614300000	A.235
ZDV 4N/2	1527930000	B.208	ZDV 4N/7 BK	2810920000	A.113	ZDV 6N/6	2733950000	B.138	ZRH 2.5/1 WS	1614300000	B.254
ZDV 4N/2	1527930000	B.209	ZDV 4N/7 BK	2810920000	A.345	ZDV 6N/6	2733950000	B.139	ZRH 2.5/2 GR/VO	1614290000	A.130
ZDV 4N/2	1527930000	B.210	ZDV 4N/7 BL	1528180000	A.110	ZDV 6N/6	2733950000	B.142	ZRH 2.5/2 GR/VO	1614290000	A.131
ZDV 4N/2	1527930000	B.211	ZDV 4N/7 BL	1528180000	A.344	ZDV 6N/6	2733950000	B.143	ZRH 2.5/2 GR/VO	1614290000	A.162
ZDV 4N/2	1527930000	B.212	ZDV 4N/7 RD	2460770000	A.110	ZDV 6N/6	2733950000	B.145	ZRH 2.5/2 GR/VO	1614290000	A.163
ZDV 4N/2	1527930000	B.213	ZDV 4N/7 RD	2460770000	A.344	ZDV 6N/6 BL	2786890000	A.111	ZRH 2.5/2 GR/VO	1614290000	A.216
ZDV 4N/2	1527930000	B.214	ZDV 4N/7 WT	2831850000	A.113	ZDV 6N/7	2733960000	A.111	ZRH 2.5/2 GR/VO	1614290000	A.217
ZDV 4N/2	1527930000	B.215	ZDV 4N/7 WT	2831850000	A.345	ZDV 6N/7	2733960000	B.134	ZRH 2.5/2 GR/VO	1614290000	A.235
ZDV 4N/2	1527930000	B.257	ZDV 4N/8	1528030000	A.110	ZDV 6N/7	2733960000	B.135	ZRH 2.5/2 GR/VO	1614290000	B.254
ZDV 4N/2	1527930000	B.258	ZDV 4N/8	1528030000	A.344	ZDV 6N/7	2733960000	B.136	ZRH 2.5/3	1614280000	A.235
ZDV 4N/2	1527930000	B.262	ZDV 4N/8 BK	2810930000	A.113	ZDV 6N/7	2733960000	B.137	ZRH 4/1 WS	1636640000	A.132
ZDV 4N/2	1527930000	B.288	ZDV 4N/8 BK	2810930000	A.345	ZDV 6N/7	2733960000	B.138	ZRH 4/1 WS	1636640000	A.133
ZDV 4N/2	1527930000	B.289	ZDV 4N/8 BL	1528190000	A.110	ZDV 6N/7	2733960000	B.139	ZRH 4/1 WS	1636640000	A.163
ZDV 4N/2 BK	2810840000	A.113	ZDV 4N/8 BL	1528190000	A.344	ZDV 6N/7	2733960000	B.142	ZRH 4/1 WS	1636640000	A.164
ZDV 4N/2 BK	2810840000	A.345	ZDV 4N/8 RD	2460760000	A.110	ZDV 6N/7	2733960000	B.143	ZRH 4/1 WS	1636640000	A.169
ZDV 4N/2 BL	1528040000	A.110	ZDV 4N/8 RD	2460760000	A.344	ZDV 6N/7	2733960000	B.145	ZRH 4/1 WS	1636640000	A.170
ZDV 4N/2 BL	1528040000	A.344	ZDV 4N/8 WT	2831860000	A.113	ZDV 6N/7 BL	2786900000	A.111	ZRH 4/1 WS	1636640000	A.235
ZDV 4N/2 BL	1528040000	B.114	ZDV 4N/8 WT	2831860000	A.345	ZDV 95/120N/2	2694250000	A.29	ZRV 1.5	1698160000	A.206
ZDV 4N/2 BL	1528040000	B.115	ZDV 4N/9	1528070000	A.110	ZDV 95/120N/2	2694250000	A.30	ZRV 1.5/PE	1698170000	A.206
ZDV 4N/2 BL	1528040000	B.116	ZDV 4N/9	1528070000	A.344	ZDV 95/120N/2	2694250000	A.112	ZRV 2.5/1	1908960000	A.207
ZDV 4N/2 BL	1528040000	B.118	ZDV 4N/9 BK	2831780000	A.113	ZDV 95/120N/2	2694250000	B.18	ZRV 2.5/2	1908970000	A.207
ZDV 4N/2 BL	1528040000	B.119	ZDV 4N/9 BK	2831780000	A.345	ZDV 95/120N/2	2694250000	B.19	ZSI 2.5	1616400000	A.177
ZDV 4N/2 RD	2460450000	A.110	ZDV 4N/9 BL	1528220000	A.110	ZDV 95/120N/2	2694250000	B.24	ZSI 2.5/2/2X2AN/G20	1826050000	A.182
ZDV 4N/2 RD	2460450000	A.344	ZDV 4N/9 BL	1528220000	A.344	ZDV 95/120N/2	2694250000	B.261	ZSI 2.5/2/2X2AN/G20/LD1	1867440000	A.184
ZDV 4N/2 RD	2460450000	B.114	ZDV 4N/9 RD	2460750000	A.110	ZDV 95/120N/3	2694260000	A.29	ZSI 2.5/2/2X2AN/G20/LD3	1867420000	A.184
ZDV 4N/2 RD	2460450000	B.115	ZDV 4N/9 RD	2460750000	A.344	ZDV 95/120N/3	2694260000	A.30	ZSI 2.5/2/2X2AN/G20/LD4	1879730000	A.184
ZDV 4N/2 RD	2460450000	B.116	ZDV 4N/9 WT	2831870000	A.113	ZDV 95/120N/3	2694260000	A.112	ZSI 2.5/2/2X2AN/G25	1826200000	A.182
ZDV 4N/2 RD	2460450000	B.118	ZDV 4N/9 WT	2831870000	A.345	ZDV 95/120N/3	2694260000	B.18	ZSI 2.5/2 500AC	1616460000	A.180
ZDV 4N/2 RD	2460450000	B.119	ZDV 50/70N/2	2663400000	A.29	ZDV 95/120N/3	2694260000	B.19	ZSI 2.5/2/LD 120AC	1616490000	A.181
ZDV 4N/2 WT	2831800000	A.113	ZDV 50/70N/2	2663400000	A.112	ZDV 95/120N/3	2694260000	B.24	ZSI 2.5/2/LD 250AC	1616500000	A.181
ZDV 4N/2 WT	2831800000	A.345	ZDV 50/70N/2	2663400000	B.16	ZDV 95/120N/3	2694260000	B.261	ZSI 2.5/2/LD 28AC	1616470000	A.181
ZDV 4N/20	2883800000	A.110	ZDV 50/70N/2	2663400000	B.17	ZR WPO4 DB	1071100000	A.330	ZSI 2.5/5X25	1730900000	A.179
ZDV 4N/20	2883800000	A.344	ZDV 50/70N/2	2663400000	B.24	ZRH 1.5H/1	1678810000	A.138	ZSI 2.5/LD 120AC	1616420000	A.179
ZDV 4N/20 BK	2810870000	A.113	ZDV 50/70N/2	2663400000	B.260	ZRH 1.5H/1	1678810000	A.139	ZSI 2.5/LD 250AC	1616410000	A.179
ZDV 4N/20 BK	2810870000	A.345	ZDV 6/2 GE	1627850000	A.133	ZRH 1.5H/1	1678810000	A.142	ZSI 2.5/LD 28AC	1616440000	A.179
ZDV 4N/20 BL	2810850000	A.110	ZDV 6/2 GE	1627850000	A.141	ZRH 1.5H/1	1678810000	A.143	ZSI 2.5/LD 60AC	1616430000	A.179
ZDV 4N/20 BL	2810850000	A.344	ZDV 6/2 GE	1627850000	A.177	ZRH 1.5H/1	1678810000	A.146	ZSI 2.5/0V	1799470000	A.178
ZDV 4N/20 RD	2810860000	A.110	ZDV 6/2 GE	1627850000	A.178	ZRH 1.5H/1	1678810000	A.147	ZSI 2X6/4X2.5	1265990000	A.190
ZDV 4N/20 RD	2810860000	A.344	ZDV 6/2 GE	1627850000	A.179	ZRH 1.5H/1	1678810000	A.148	ZSI 2X6/4X2.5 FC	1058520000	A.189
ZDV 4N/3	1527940000	A.110	ZDV 6/2 GE	1627850000	A.188	ZRH 1.5H/1	1678810000	A.149	ZSI 6-2 2X2.5/G20	1820930000	A.186
ZDV 4N/3	1527940000	A.344	ZDV 6/2 GE	1627850000	A.189	ZRH 1.5H/1	1678810000	A.151	ZSI 6-2 2X2.5/G20/LD1	1867500000	A.187
ZDV 4N/3	1527940000	B.288	ZDV 6/2 GE	1627850000	A.190	ZRH 1.5H/1	1678810000	A.152	ZSI 6-2 2X2.5/G20/LD4	1879750000	A.187
ZDV 4N/3	1527940000	B.289	ZDV 6/2 GE	1627850000	A.193	ZRH 1.5H/1	1678810000	A.153	ZSI 6-2 2X2.5/G25	1820950000	A.187
ZDV 4N/3 BK	2810880000	A.113	ZDV 6/2 GE	1627850000	A.219	ZRH 1.5H/1	1678810000	A.154	ZSI 6-2/FC	1814690000	A.188
ZDV 4N/3 BK	2810880000	A.345	ZDV 6/2 GE	1627850000	A.231	ZRH 1.5H/1	1678810000	A.158	ZSI 6-2/FC LD	1814700000	A.188
ZDV 4N/3 BL	1528080000	A.110	ZDV 6/2 GE	1627850000	B.157	ZRH 1.5H/1	1678810000	A.159	ZST	1678680000	A.237
ZDV 4N/3 BL	1528080000	A.344	ZDV 6/24 GE	1908990000	A.231	ZRH 1.5H/1	1678810000	A.168	ZST 1	1269070000	A.237
ZDV 4N/3 RD	2460810000	A.110	ZDV 6/3 GE	1627860000	A.231	ZRH 1.5H/1	1678810000	A.169	ZT 2.5/2AN/1	1815070000	A.196
ZDV 4N/3 RD	2460810000	A.344	ZDV 6/3 GE	1627860000	B.157	ZRH 1.5H/1	1678810000	A.172	ZT 2.5/2AN/1 BL	1295550000	A.196
ZDV 4N/3 WT	2831810000	A.113	ZDV 6/32 GE	1733640000	B.156	ZRH 1.5H/1	1678810000	A.173	ZT 2.5/3AN/1	1815090000	A.196
ZDV 4N/3 WT	2831810000	A.345	ZDV 6/4 GE	1627870000	A.133	ZRH 1.5H/1	1678810000	A.174	ZT 2.5/3AN/1 BL	1304720000	A.196
ZDV 4N/4	1527970000	A.110	ZDV 6/4 GE	1627870000	A.135	ZRH 1.5H/1	1678810000	A.175	ZT 2.5/4AN/2	1815110000	A.197
ZDV 4N/											

Type	Order No.	Page	Type	Order No.	Page
ZTA 1/ZA	1609050000	B.254	ZTR 6-2 E / 230V UC	8817930000	B.268
ZTA 2 ZDU4	1609060000	A.132	ZTR 6-2 E / 24V UC	8817920000	B.268
ZTA 2 ZDU4	1609060000	A.133	ZTRR 2.5	1865510000	A.205
ZTA 2 ZDU4	1609060000	A.163	ZTRR 2.5 0.TNHE	1905470000	A.205
ZTA 2 ZDU4	1609060000	A.164	ZTW ZTL6	1771870000	B.156
ZTA 2 ZDU4	1609060000	A.232	ZTW ZTL6	1771870000	B.157
ZTA 2/ZA ZDU4	1609070000	A.132	ZUB MULTIMETER	9205270000	B.106
ZTA 2/ZA ZDU4	1609070000	A.133	ZUB MULTIMETER	9205270000	B.107
ZTA 2/ZA ZDU4	1609070000	A.163	ZUB MULTIMETER	9205270000	B.112
ZTA 2/ZA ZDU4	1609070000	A.164	ZUB MULTIMETER	9205270000	B.113
ZTA 2/ZA ZDU4	1609070000	A.232	ZVL 1.5	1649300000	B.189
ZTA 3 ZDU6	1654050000	A.129	ZVL 1.5 BL	1650360000	B.189
ZTA 3 ZDU6	1654050000	A.133	ZVL 1.5 BR	1650370000	B.189
ZTA 3 ZDU6	1654050000	A.165	ZVL 1.5 0.OV	1711930000	B.189
ZTA 3 ZDU6	1654050000	A.232	ZVL 1.5/PE GN/GE BED	1651970000	B.189
ZTA 4	1688110000	A.138	ZVLA DF ZPS2.5	1878600000	A.214
ZTA 4	1688110000	A.139	ZVLA RC ZPS2.5	1866260000	A.215
ZTA 4	1688110000	A.148	ZVLA SC ZPS2.5	1866240000	A.215
ZTA 4	1688110000	A.149	ZVLD 2.5	1208920000	A.150
ZTA 4	1688110000	A.152	ZVQ 2.5/1.5	1720700000	A.8
ZTA 4	1688110000	A.154	ZVQ 2.5/1.5	1720700000	A.9
ZTA 4	1688110000	A.168	ZVQ 2.5/1.5	1720700000	A.44
ZTA 4	1688110000	A.169	ZVQ 2.5/1.5	1720700000	A.148
ZTA 4	1688110000	A.174	ZVQ 2.5/1.5	1720700000	A.149
ZTA 4	1688110000	A.175	ZVQ 2.5/1.5	1720700000	A.150
ZTA 4	1688110000	A.233	ZVQ 2.5/1.5	1720700000	A.231
ZTA 6/ZA	1780660000	A.139	ZVQ 2.5/1.5	1720700000	A.321
ZTA 6/ZA	1780660000	A.140	ZVQ 2.5/1.5	1720700000	B.94
ZTA 6/ZA	1780660000	A.155	ZVQ 2.5/1.5	1720700000	B.211
ZTA 6/ZA	1780660000	A.156	ZVQ 2.5/1.5	1720700000	B.212
ZTA 6/ZA	1780660000	A.157	ZVR ZP2.5	1816130000	A.196
ZTA 6/ZA	1780660000	A.169	ZVR ZP2.5	1816130000	A.197
ZTA 6/ZA	1780660000	A.170	ZVR ZP2.5	1816130000	A.199
ZTA 6/ZA	1780660000	A.175	ZVR ZP2.5	1816130000	A.200
ZTA 6/ZA	1780660000	A.232	ZVR ZP2.5	1816130000	A.202
ZTA 7/ZA	1780670000	A.141	ZVR ZP2.5	1816130000	A.203
ZTA 7/ZA	1780670000	A.170	ZVR ZP2.5	1816130000	A.204
ZTA 7/ZA	1780670000	A.171	ZVR ZP2.5	1816130000	A.213
ZTA 7/ZA	1780670000	A.232	ZVR ZP4	1855250000	A.198
ZTA 7/ZA	1780670000	B.268	ZVR ZP4	1855250000	A.201
ZTA ZDK 2.5	1052860000	A.146	ZVR ZP4	1855250000	A.213
ZTA ZDK 2.5	1052860000	A.147	ZVR ZP4	1855250000	A.322
ZTA ZDK 2.5/ZA	1052880000	A.146	ZVR ZP4	1855250000	A.325
ZTA ZDK 2.5/ZA	1052880000	A.147	ZVR ZPS2.5	1878620000	A.213
ZTA ZT2.5	1827080000	A.142	ZVR ZPS2.5	1878620000	A.214
ZTA ZT2.5	1827080000	A.143	ZZE ZP2.5	1816140000	A.196
ZTA ZT2.5	1827080000	A.158	ZZE ZP2.5	1816140000	A.197
ZTA ZT2.5	1827080000	A.159	ZZE ZP2.5	1816140000	A.199
ZTA ZT2.5	1827080000	A.172	ZZE ZP2.5	1816140000	A.200
ZTA ZT2.5	1827080000	A.173	ZZE ZP2.5	1816140000	A.202
ZTA ZT2.5	1827080000	A.176	ZZE ZP2.5	1816140000	A.203
ZTA ZT2.5	1827080000	A.196	ZZE ZP2.5	1816140000	A.204
ZTA ZT2.5	1827080000	A.197	ZZE ZP2.5	1816140000	A.213
ZTA ZT2.5	1827080000	A.199	ZZE ZP2.5/4	1866220000	A.213
ZTA ZT2.5	1827080000	A.200	ZZE ZP2.5/8	1866230000	A.213
ZTA ZT2.5	1827080000	A.201	ZZE ZP4	1855260000	A.198
ZTA ZT2.5	1827080000	A.202	ZZE ZP4	1855260000	A.201
ZTA ZT2.5	1827080000	A.203	ZZE ZP4	1855260000	A.213
ZTA ZT2.5	1827080000	A.204	ZZE ZP4	1855260000	A.322
ZTA ZT2.5	1827080000	A.208			
ZTA ZT2.5	1827080000	A.209			
ZTA ZT2.5	1827080000	A.232			
ZTA ZT2.5/ZA	1847600000	A.142			
ZTA ZT2.5/ZA	1847600000	A.143			
ZTA ZT2.5/ZA	1847600000	A.153			
ZTA ZT2.5/ZA	1847600000	A.158			
ZTA ZT2.5/ZA	1847600000	A.159			
ZTA ZT2.5/ZA	1847600000	A.172			
ZTA ZT2.5/ZA	1847600000	A.173			
ZTA ZT2.5/ZA	1847600000	A.176			
ZTA ZT2.5/ZA	1847600000	A.196			
ZTA ZT2.5/ZA	1847600000	A.197			
ZTA ZT2.5/ZA	1847600000	A.199			
ZTA ZT2.5/ZA	1847600000	A.200			
ZTA ZT2.5/ZA	1847600000	A.202			
ZTA ZT2.5/ZA	1847600000	A.203			
ZTA ZT2.5/ZA	1847600000	A.204			
ZTA ZT2.5/ZA	1847600000	A.232			
ZTD 6	1771810000	B.156			
ZTD 6	1771810000	B.157			
ZTD 6/STB	1771960000	B.157			
ZTL 6	1771800000	B.156			
ZTL 6	1771800000	B.157			
ZTL 6/STB	1771950000	B.157			
ZTPE 2.5/2AN/1	1815080000	A.199			
ZTPE 2.5/3AN/1	1815100000	A.199			
ZTPE 2.5/4AN/2	1815120000	A.200			
ZTPE 2.5/4AN/4	1815140000	A.200			
ZTPE 4/2AN/1	1854970000	A.201			
ZTPE 4/4AN/2	1848330000	A.201			
ZTR 2.5	1831280000	A.192			
ZTR 2.5 BL	8731710000	A.192			
ZTR 2.5-2	1779010000	A.193			
ZTR 2.5-2 BL	1779120000	A.193			
ZTR 2.5/3AN	8731720000	A.192			
ZTR 2.5/3AN BL	8731730000	A.192			
ZTR 2.5/4AN	7920900000	A.193			
ZTR 2.5/4AN BL	7920930000	A.193			
ZTR 6-2	1023830000	A.193			

Order No.	Type	Page
-----------	------	------

010000000

0101700000	TST 2/M6	C.22
0103300000	BFSC M4X9T	A.297
0103300000	BFSC M4X9T	A.298
0103300000	BFSC M4X9T	C.12

011000000

0117500000	TS 15X5/LL 2M/ST/ZN	C.17
0117510000	TS 15X5/LL 1M/ST/ZN	C.17

012000000

0122800000	TS 32X15 2M/ST/ZN	B.145
0122800000	TS 32X15 2M/ST/ZN	C.18

013000000

0136400000	SS M4 D 128-A4	A.297
0136400000	SS M4 D 128-A4	A.298
0137400000	E 14/2A RS	A.297
0137400000	E 14/2A RS	A.304
0137500000	E 14/4A BR	A.297
0137500000	E 14/4A BR	A.304
0138000000	P 14/2 D01 RS SAKS4	A.297
0138000000	P 14/2 D01 RS SAKS4	A.305
0138100000	P 14/4 D01 BR SAKS4	A.297
0138100000	P 14/4 D01 BR SAKS4	A.305

016000000

0164000000	TSTW 6/M6	C.22
0164400000	SS M3 D 128-A3	A.289
0164400000	SS M3 D 128-A3	A.290
0164400000	SS M3 D 128-A3	A.291
0164400000	SS M3 D 128-A3	A.292
0164400000	SS M3 D 128-A3	A.294
0169300000	TS 32X15 2M/AL/BK	C.18
0169900000	STB 14/D6/4/M3 SAK10	B.162
0169900000	STB 14/D6/4/M3 SAK10	B.170

017000000

0178100000	TSTW 5/M5	C.22
------------	-----------	------

018000000

0180400000	PS 2.3 RT	A.134
0180400000	PS 2.3 RT	A.135
0180400000	PS 2.3 RT	A.192
0180400000	PS 2.3 RT	A.193
0180400000	PS 2.3 RT	A.194
0180400000	PS 2.3 RT	A.205
0180400000	PS 2.3 RT	A.233
0180400000	PS 2.3 RT	A.240
0180400000	PS 2.3 RT	A.242
0180400000	PS 2.3 RT	A.244
0180400000	PS 2.3 RT	A.308
0180400000	PS 2.3 RT	A.309
0180400000	PS 2.3 RT	A.310
0180400000	PS 2.3 RT	A.311
0180400000	PS 2.3 RT	A.312
0180400000	PS 2.3 RT	A.318
0180400000	PS 2.3 RT	A.319
0180400000	PS 2.3 RT	B.158

019000000

0192700000	G 25/2.00A/F BL	A.179
0192700000	G 25/2.00A/F BL	A.182
0192700000	G 25/2.00A/F BL	A.187
0192700000	G 25/2.00A/F BL	A.191
0192700000	G 25/2.00A/F BL	A.304
0192800000	G 25/4.00A/F BR	A.179
0192800000	G 25/4.00A/F BR	A.182
0192800000	G 25/4.00A/F BR	A.187
0192800000	G 25/4.00A/F BR	A.191
0192800000	G 25/4.00A/F BR	A.304
0192900000	G 25/6.30A/F GN	A.191
0192900000	G 25/6.30A/F GN	A.304
0193100000	G 25/10.0A/M RT	A.191
0193100000	G 25/10.0A/M RT	A.304
0194300000	QL 2 SAK6N	A.289
0194300000	QL 2 SAK6N	A.290
0194300000	QL 2 SAK6N	A.293
0194300000	QL 2 SAK6N	B.163
0194400000	QL 3 SAK6N	B.163
0194400000	QL 3 SAK6N	B.171
0194500000	QL 4 SAK6N	B.163
0194500000	QL 4 SAK6N	B.171
0199360000	EWK 2	C.21

020000000

0206160000	EWK 1	B.156
0206160000	EWK 1	B.166
0206160000	EWK 1	B.176

Order No.	Type	Page
-----------	------	------

0206160000	EWK 1	C.21
0207800000	DL 2 SAKS2	A.297
0207800000	DL 2 SAKS2	A.298
0208500000	E 16/10A RT TNDZ	A.297
0208500000	E 16/10A RT TNDZ	A.304
0208600000	E 16/16A GR TNDZ	A.297
0208600000	E 16/16A GR TNDZ	A.304
0208700000	E 16/20A BL TNDZ	A.297
0208700000	E 16/20A BL TNDZ	A.304
0208800000	E 16/25A GE TNDZ	A.297
0208800000	E 16/25A GE TNDZ	A.304

021000000

0215700000	STB 8.5/D4/2.3/M2.5 AKZ	A.240
0215700000	STB 8.5/D4/2.3/M2.5 AKZ	A.242
0215700000	STB 8.5/D4/2.3/M2.5 AKZ	A.244

022000000

0221200000	QL 15 SAK6N	B.171
------------	-------------	-------

023000000

0236400000	TS 35X15 2M/ST/ZN	C.19
0236500000	TS 35X15/LL 2M/ST/ZN	B.145
0236500000	TS 35X15/LL 2M/ST/ZN	B.246
0236500000	TS 35X15/LL 2M/ST/ZN	B.247
0236500000	TS 35X15/LL 2M/ST/ZN	C.19
0236510000	TS 35X15/LL 1M/ST/ZN	C.19

024000000

0241260000	MK 2/12	A.336
0243520000	MK 3/12	A.336
0243820000	MK 5/2 D2	A.338
0244060000	D 2 MK5/2 PA/NA	A.338
0244220000	MK 4/16	A.337
0249000000	VH 12/4.9/3.3 SAK6N	B.163
0249000000	VH 12/4.9/3.3 SAK6N	B.164
0249000000	VH 12/4.9/3.3 SAK6N	B.171

026000000

0265800000	G 25/1.00A/M RT	A.179
0265800000	G 25/1.00A/M RT	A.182
0265800000	G 25/1.00A/M RT	A.187
0265800000	G 25/1.00A/M RT	A.191
0265800000	G 25/1.00A/M RT	A.304
0266500000	ZB 35/M6X16	B.298
0266500000	ZB 35/M6X16	B.299
0266500000	ZB 35/M6X16	B.300
0266500000	ZB 35/M6X16	B.304
0266500000	ZB 35/M6X16	B.305
0267100000	BFSC M4X30	C.12
0267200000	STB 25 IH/GE	B.162

027000000

0270100000	TS 35X15/2.3 2M/CU/BK	B.24
0270100000	TS 35X15/2.3 2M/CU/BK	C.19
0270760000	QS 2/12/4	B.171
0270860000	QS 2/10/4	B.171
0270960000	QS 2/8/4	B.160
0270960000	QS 2/8/4	B.161
0270960000	QS 2/8/4	B.171
0271200000	STB 25 IH/GN	B.162
0271300000	STB 25 IH/VI	B.162
0273820000	MK 3/2	A.336
0273920000	MK 3/3	A.336
0274020000	MK 3/4	A.336
0274120000	MK 3/5	A.336
0274220000	MK 3/6	A.336
0274320000	MK 3/7	A.336
0274420000	MK 3/8	A.336
0274620000	MK 3/10	A.336

028000000

0280100000	DKSUE NSCH/ESCH	C.12
0280200000	NSCH 1M	C.12
0280300000	ESCH 1 M	C.12
0280600000	STB 8.5/5/2.3/M3 SAK2.5	B.158
0284110000	SK E16/SAKS2	A.297

029000000

0293220000	TS 32X15 2M/PRN	C.18
0293800000	PS 2.0 DR	A.233
0294360000	AKZ 4	A.244
0294380000	AKZ 4 BL	A.244
0294460000	AP AKZ4	A.244
0294460000	AP AKZ4	A.274
0294480000	AP AKZ4 BL	A.244
0295900000	FKSC M5X8 D9/SW2.5	C.22
0296700000	BFSC M5X8 SCHLITZ	C.12
0299600000	PS 4 F.STB 4	B.157
0299600000	PS 4 F.STB 4	B.160
0299600000	PS 4 F.STB 4	B.164

Order No.	Type	Page
-----------	------	------

0299600000	PS 4 F.STB 4	B.177
0299860000	SH 1	C.12

030000000

0307300000	QVS 2 SAKT1+2	B.162
0307300000	QVS 2 SAKT1+2	B.163
0307300000	QVS 2 SAKT1+2	B.164
0307300000	QVS 2 SAKT1+2	B.170
0307400000	QVS 4 SAKT1+2	B.170
0309700000	VH 16/5/3.5 SAK10-35	B.166
0309700000	VH 16/5/3.5 SAK10-35	B.167
0309700000	VH 16/5/3.5 SAK10-35	B.168
0309700000	VH 16/5/3.5 SAK10-35	B.169
0309700000	VH 16/5/3.5 SAK10-35	B.171

031000000

0310000000	PS 2.0 MC	A.6
0310000000	PS 2.0 MC	A.7
0310000000	PS 2.0 MC	A.8
0310000000	PS 2.0 MC	A.9
0310000000	PS 2.0 MC	A.10
0310000000	PS 2.0 MC	A.11
0310000000	PS 2.0 MC	A.12
0310000000	PS 2.0 MC	A.16
0310000000	PS 2.0 MC	A.17
0310000000	PS 2.0 MC	A.18
0310000000	PS 2.0 MC	A.19
0310000000	PS 2.0 MC	A.20
0310000000	PS 2.0 MC	A.21
0310000000	PS 2.0 MC	A.22
0310000000	PS 2.0 MC	A.23
0310000000	PS 2.0 MC	A.24
0310000000	PS 2.0 MC	A.25
0310000000	PS 2.0 MC	A.26
0310000000	PS 2.0 MC	A.27
0310000000	PS 2.0 MC	A.28
0310000000	PS 2.0 MC	A.29
0310000000	PS 2.0 MC	A.30
0310000000	PS 2.0 MC	A.31
0310000000	PS 2.0 MC	A.32
0310000000	PS 2.0 MC	A.33
0310000000	PS 2.0 MC	A.34
0310000000	PS 2.0 MC	A.35
0310000000	PS 2.0 MC	A.36
0310000000	PS 2.0 MC	A.37
0310000000	PS 2.0 MC	A.38
0310000000	PS 2.0 MC	A.39
0310000000	PS 2.0 MC	A.40
0310000000	PS 2.0 MC	A.41
0310000000	PS 2.0 MC	A.42
0310000000	PS 2.0 MC	A.43
0310000000	PS 2.0 MC	A.44
0310000000	PS 2.0 MC	A.46
0310000000	PS 2.0 MC	A.47
0310000000	PS 2.0 MC	A.48
0310000000	PS 2.0 MC	A.49
0310000000	PS 2.0 MC	A.50
0310000000	PS 2.0 MC	A.51
0310000000	PS 2.0 MC	A.52
0310000000	PS 2.0 MC	A.53
0310000000	PS 2.0 MC	A.54
0310000000	PS 2.0 MC	A.55
0310000000	PS 2.0 MC	A.56
0310000000	PS 2.0 MC	A.57
0310000000	PS 2.0 MC	A.58
0310000000	PS 2.0 MC	A.59
0310000000	PS 2.0 MC	A.60
0310000000	PS 2.0 MC	A.61
0310000000	PS 2.0 MC	A.62
0310000000	PS 2.0 MC	A.63
0310000000	PS 2.0 MC	A.64
0310000000	PS 2.0 MC	A.66
0310000000	PS 2.0 MC	A.67
0310000000	PS 2.0 MC	

Order No.	Type	Page
0338300000	QL 10 SAK6N	B.163
0338300000	QL 10 SAK6N	B.171
0338900000	QL 10 SAKS2	A.297
0338900000	QL 10 SAKS2	A.298
0339000000	QL 10 SAKS4	A.297
0339410000	SK E14 SAKS4	A.297

0340000000

0340460000	AKZ 1.5	A.240
0340480000	AKZ 1.5 BL	A.240
0340560000	AP AKZ1.5	A.240
0340580000	AP AKZ1.5 BL	A.240
0341000000	STB 30.5 IH/SW	B.160
0341000000	STB 30.5 IH/SW	B.170
0341100000	STB 30.5 IH/GR	B.160
0341100000	STB 30.5 IH/GR	B.170
0341200000	STB 30.5 IH/BL	B.160
0341200000	STB 30.5 IH/BL	B.161
0341200000	STB 30.5 IH/BL	B.170
0341300000	STB 30.5 IH/RT	B.160
0341300000	STB 30.5 IH/RT	B.170
0341400000	STB 30.5 IH/GN	B.160
0341400000	STB 30.5 IH/GN	B.161
0341400000	STB 30.5 IH/GN	B.170
0341500000	STB 30.5 IH/GE	B.160
0341500000	STB 30.5 IH/GE	B.161
0341500000	STB 30.5 IH/GE	B.170
0341600000	STB 30.5 IH/VI	B.160
0341600000	STB 30.5 IH/VI	B.161
0341600000	STB 30.5 IH/VI	B.170
0343400000	STB 25 IH/BL	B.162
0348260000	TW AKZ4	A.244
0348900000	SSCH 10X3X1000 CU/SN	B.235
0348900000	SSCH 10X3X1000 CU/SN	B.236
0348900000	SSCH 10X3X1000 CU/SN	B.242
0348900000	SSCH 10X3X1000 CU/SN	B.243
0348900000	SSCH 10X3X1000 CU/SN	B.278
0348900000	SSCH 10X3X1000 CU/SN	B.279
0348900000	SSCH 10X3X1000 CU/SN	B.280
0348900000	SSCH 10X3X1000 CU/SN	B.281
0348900000	SSCH 10X3X1000 CU/SN	B.282
0348900000	SSCH 10X3X1000 CU/SN	B.283
0348900000	SSCH 10X3X1000 CU/SN	B.284
0348900000	SSCH 10X3X1000 CU/SN	B.285
0348900000	SSCH 10X3X1000 CU/SN	B.286
0348900000	SSCH 10X3X1000 CU/SN	B.287
0348900000	SSCH 10X3X1000 CU/SN	B.288
0348900000	SSCH 10X3X1000 CU/SN	B.289
0348900000	SSCH 10X3X1000 CU/SN	B.298
0348900000	SSCH 10X3X1000 CU/SN	B.299
0348900000	SSCH 10X3X1000 CU/SN	B.300
0348900000	SSCH 10X3X1000 CU/SN	B.304
0348900000	SSCH 10X3X1000 CU/SN	B.305
0348900000	SSCH 10X3X1000 CU/SN	B.312

0350000000

0353500000	FKSC M6X12 D9/SW3	C.22
0353660000	TSCH 2	B.162
0357400000	SSCH 15X6X1000 CU/SN	C.12
0358460000	QVS 2/S SAKT1+2	B.170
0359310000	SK E18 SAKS5	A.298

0360000000

0361300000	E 18/20A BL	A.298
0361300000	E 18/20A BL	A.305
0361400000	E 18/25A GE	A.298
0361400000	E 18/25A GE	A.305
0361500000	E 18/35A SW	A.298
0361500000	E 18/35A SW	A.305
0361600000	E 18/50A WS	A.305
0361700000	E 18/63A KU	A.305
0361800000	P 18/20 D02 BL SAKS5	A.298
0361800000	P 18/20 D02 BL SAKS5	A.305
0361900000	P 18/25 D02 GE SAKS5	A.298
0361900000	P 18/25 D02 GE SAKS5	A.305
0362000000	P 18/35 D02 SW SAKS5	A.298
0362000000	P 18/35 D02 SW SAKS5	A.305
0362100000	P 18/50 D02 WS SAKS5	A.298
0362100000	P 18/50 D02 WS SAKS5	A.305
0368200000	Q 2 AKZ1.5	A.240
0368200000	Q 2 AKZ1.5	A.242
0368200000	Q 2 AKZ1.5	A.350
0368300000	Q 3 AKZ1.5	A.350
0368400000	Q 4 AKZ1.5	A.350
0368500000	Q 10 AKZ1.5	A.240
0368500000	Q 10 AKZ1.5	A.242
0368500000	Q 10 AKZ1.5	A.350
0368600000	Q 10 AKZ4	A.244
0368600000	Q 10 AKZ4	A.350
0368900000	Q 2 AKZ4SS	A.265
0368900000	Q 2 AKZ4SS	A.350
0369300000	Q 10 AKZ4SS	A.265
0369300000	Q 10 AKZ4SS	A.350

Order No.	Type	Page
0377100000	KISC M3X20 SAK10 CU5	A.293
0377100000	KISC M3X20 SAK10 CU5	B.163
0377100000	KISC M3X20 SAK10 CU5	B.164

0380000000

0380260000	AKE 4	A.274
0382860000	EW 15	A.240
0382860000	EW 15	A.242
0382860000	EW 15	A.244
0382860000	EW 15	A.262
0382860000	EW 15	A.272
0382860000	EW 15	A.273
0382860000	EW 15	A.274
0382860000	EW 15	C.21
0383400000	TS 35X7.5 2M/ST/ZN	B.246
0383400000	TS 35X7.5 2M/ST/ZN	B.247
0383400000	TS 35X7.5 2M/ST/ZN	C.18
0383410000	TS 35X7.5 1M/ST/ZN	C.18
0383530000	EW 35 GR 7032	C.21
0383560000	EW 35	A.243
0383560000	EW 35	B.190
0383560000	EW 35	B.191
0383560000	EW 35	B.192
0383560000	EW 35	B.193
0383560000	EW 35	C.21
0388500000	STB 35 IH/SW	B.170
0388600000	STB 35 IH/GR	B.170
0388700000	STB 35 IH/BL	B.163
0388700000	STB 35 IH/BL	B.164
0388700000	STB 35 IH/BL	B.170
0388800000	STB 35 IH/RT	B.170
0388900000	STB 35 IH/GN	B.162
0388900000	STB 35 IH/GN	B.163
0388900000	STB 35 IH/GN	B.164
0388900000	STB 35 IH/GN	B.170
0388900000	STB 35 IH/GN	B.171
0388900000	STB 35 IH/VI	B.162
0389100000	STB 35 IH/VI	B.163
0389100000	STB 35 IH/VI	B.164
0389100000	STB 35 IH/VI	B.170

0400000000

0401460000	SO SH1	C.12
------------	--------	------

0430000000

0430300000	G 20/0.10A/F	A.191
0430300000	G 20/0.10A/F	A.304
0430400000	G 20/0.20A/F	A.191
0430400000	G 20/0.20A/F	A.304
0430500000	G 20/0.25A/F	A.61
0430500000	G 20/0.25A/F	A.62
0430500000	G 20/0.25A/F	A.63
0430500000	G 20/0.25A/F	A.64
0430500000	G 20/0.25A/F	A.177
0430500000	G 20/0.25A/F	A.178
0430500000	G 20/0.25A/F	A.179
0430500000	G 20/0.25A/F	A.182
0430500000	G 20/0.25A/F	A.184
0430500000	G 20/0.25A/F	A.186
0430500000	G 20/0.25A/F	A.187
0430500000	G 20/0.25A/F	A.188
0430500000	G 20/0.25A/F	A.191
0430500000	G 20/0.25A/F	A.284
0430500000	G 20/0.25A/F	A.285
0430500000	G 20/0.25A/F	A.286
0430500000	G 20/0.25A/F	A.287
0430500000	G 20/0.25A/F	A.289
0430500000	G 20/0.25A/F	A.290
0430500000	G 20/0.25A/F	A.293
0430500000	G 20/0.25A/F	A.304
0430500000	G 20/0.25A/F	B.116
0430500000	G 20/0.25A/F	B.119
0430500000	G 20/0.25A/F	B.208
0430500000	G 20/0.25A/F	B.209
0430500000	G 20/0.25A/F	B.210
0430500000	G 20/0.25A/F	B.211
0430500000	G 20/0.25A/F	B.212
0430500000	G 20/0.25A/F	B.215
0430600000	G 20/0.50A/F	A.61
0430600000	G 20/0.50A/F	A.62
0430600000	G 20/0.50A/F	A.63
0430600000	G 20/0.50A/F	A.64
0430600000	G 20/0.50A/F	A.177
0430600000	G 20/0.50A/F	A.178
0430600000	G 20/0.50A/F	A.179
0430600000	G 20/0.50A/F	A.182
0430600000	G 20/0.50A/F	A.184
0430600000	G 20/0.50A/F	A.186
0430600000	G 20/0.50A/F	A.187
0430600000	G 20/0.50A/F	A.188
0430600000	G 20/0.50A/F	A.191
0430600000	G 20/0.50A/F	A.284
0430600000	G 20/0.50A/F	A.285
0430600000	G 20/0.50A/F	A.286
0430600000	G 20/0.50A/F	A.287
0430600000	G 20/0.50A/F	A.289
0430600000	G 20/0.50A/F	A.290
0430600000	G 20/0.50A/F	A.293
0430600000	G 20/0.50A/F	A.304
0431000000	G 20/2.00A/F	A.61
0431000000	G 20/2.00A/F	A.62
0431000000	G 20/2.00A/F	A.63
0431000000	G 20/2.00A/F	A.64
0431000000	G 20/2.00A/F	A.177
0431000000	G 20/2.00A/F	A.178
0431000000	G 20/2.00A/F	A.179
0431000000	G 20/2.00A/F	A.182
0431000000	G 20/2.00A/F	A.184
0431000000	G 20/2.00A/F	A.186
0431000000	G 20/2.00A/F	A.187
0431000000	G 20/2.00A/F	A.188
0431000000	G 20/2.00A/F	A.191
0431000000	G 20/2.00A/F	A.284
0431000000	G 20/2.00A/F	A.285
0431000000	G 20/2.00A/F	A.286
0431000000	G 20/2.00A/F	A.287
0431000000	G 20/2.00A/F	A.289
0431000000	G 20/2.00A/F	A.290
0431000000	G 20/2.00A/F	A.293
0431000000	G 20/2.00A/F	A.304
0431000000	G 20/2.00A/F	B.116
0431000000	G 20/2.00A/F	B.119
0431000000	G 20/2.00A/F	B.208
0431000000	G 20/2.00A/F	B.209
0431000000	G 20/2.00A/F	B.210
0431000000	G 20/2.00A/F	B.211
0431000000	G 20/2.00A/F	B.212
0431000000	G 20/2.00A/F	B.215
0431000000	G 20/3.15A/F	A.191
0431000000	G 20/3.15A/F	A.304
0431000000	G 20/4.00A/F	A.191
0431200000	G 20/4.00A/F	A.304
0431300000	G 20/5.00A/F	A.191
0431300000	G 20/5.00A/F	A.304
0431400000	G 20/6.30A/F	A.191
0431400000	G 20/6.30A/F	A.304
0438000000	SSCH 10X3X1000 ST/ZN	C.12
0439000000	G 20/0.63A/F	A.191

Order No.	Type	Page
0430600000	G 20/0.50A/F	A.187
0430600000	G 20/0.50A/F	A.191
0430600000	G 20/0.50A/F	A.284
0430600000	G 20/0.50A/F	A.285
0430600000	G 20/0.50A/F	A.286
0430600000	G 20/0.50A/F	A.287
0430600000	G 20/0.50A/F	A.289
0430600000	G 20/0.50A/F	A.290
0430600000	G 20/0.50A/F	A.293
0430600000	G 20/0.50A/F	A.299
0430600000	G 20/0.50A/F	A.300
0430600000	G 20/0.50A/F	A.301
0430600000	G 20/0.50A/F	A.302
0430600000	G 20/0.50A/F	A.304
0430600000	G 20/0.50A/F	B.116
0430600000	G 20/0.50A/F	B.119
0430600000	G 20/0.50A/F	B.208
0430600000	G 20/0.50A/F	B.209
0430600000	G 20/0.50A/F	B.210
0430600000	G 20/0.50A/F	B.213
0430600000	G 20/0.50A/F	B.214
0430600000	G 20/0.50A/F	B.215
0430700000	G 20/1.00A/F	A.61
0430700000	G 20/1.00A/F	A.62
0430700000	G 20/1.00A/F	A.63
0430700000	G 20/1.00A/F	A.64
0430700000	G 20/1.00A/F	A.177
0430700000	G 20/1.00A/F	A.178
0430700000	G 20/1.00A/F	A.179
0430700000	G 20/1.00A/F	A.182
0430700000	G 20/1.00A/F	A.184
0430700000	G 20/1.00A/F	A.186
0430700000	G 20/1.00A/F	A.187
0430700000	G 20/1.00A/F	A.191
0430700000	G 20/1.00A/F	A.284
0430700000	G 20/1.00A/F	A.285
0430700000	G 20/1.00A/F	A.286
0430700000	G 20/1.00A/F	A.287
0430700000	G 20/1.00A/F	A.289
0430700000	G 20/1.00A/F	A.290
0430700000	G 20/1.00A/F	A.293
0430700000	G 20/1.00A/F	A.299
0430700000	G 20/1.00A/F	A.300
0430700000	G 20/1.00A/F	A.301
0430700000	G 20/1.00A/F	A.302

Order No.	Type	Page
-----------	------	------

0570000000

0571300000	SSCH 6X6X1000 CU/SN	C.12
------------	---------------------	------

0620000000

0620120000	MK 6/6	A.337
0620220000	MK 6/4	A.337
0620320000	MK 6/3	A.337
0620420000	MK 6/2	A.337
0624270000	BK 2 CRN	A.338
0624920000	BK 3 CRN	A.338
0625120000	BK 4 CRN	A.338
0625220000	BK 6 CRN	A.338
0625320000	BK 12 CRN	A.338

0630000000

0635960000	KLBU SH1	C.12
0636800000	FM 5/TS35	C.22
0638900000	FM 6/TS35	C.22

0640000000

0641720000	SH 2 S	C.13
0642600000	FKSC M6X8 D9/SW3	C.22
0646210000	MOFU 35/LO/1 SW	C.22
0646260000	MOFU 35/LO/1	C.22
0646400000	G 25/0.80A/MGR	A.191
0646400000	G 25/0.80A/MGR	A.304

0680000000

0687900000	FM 4/TS35	C.22
------------	-----------	------

0690000000

0697160000	AKZ 2.5	A.242
0697180000	AKZ 2.5 BL	A.242
0697360000	AP AKZ2.5	A.242
0697380000	AP AKZ2.5 BL	A.242

1000000000

1007810000	ZP 2.5/2AN/QV	A.212
1007830000	ZP 2.5/2AN/QV GN	A.212
1007870000	ZP 2.5/2AN/QV ZA O.RA	A.212
1007880000	ZP 2.5/2AN/QV ZAO.RA BL	A.212
1007900000	ZP 2.5/1AN/QV	A.212
1007920000	ZP 2.5/1AN/QV GN	A.212
1007930000	ZP 2.5/1AN/QV ZA	A.212
1007950000	ZP 2.5/1AN/QV ZA GN	A.212
1007960000	ZP 2.5/1AN/QV ZA O.RA	A.212
1007970000	ZP 2.5/1AN/QV ZAO.RA BL	A.212
1007980000	ZP 2.5/1AN/QV ZAO.RA GN	A.212
1009060000	ZP 2.5/1AN/1 BL	A.212
1009070000	ZP 2.5/1AN ZA BL	A.212

1010000000

1010000000	WPE 2.5	A.273
1010010000	WPE 2.5 WS	B.251
1010010000	WPE 2.5 WS	B.255
1010100000	WPE 4	A.275
1010200000	WPE 6	A.276
1010300000	WPE 10	A.277
1010400000	WPE 16	A.277
1010500000	WPE 35	A.278
1010500000	WPE 35	B.32
1010600000	WNT 2.5 10X3 BE	B.298
1010680000	WNT 2.5 10X3	B.298
1010780000	WNT 4 10X3	B.298
1010880000	WNT 6 10X3	B.299
1010900000	WNT 10 10X3 BE	B.299
1010980000	WNT 10 10X3	B.299
1011000000	WSI 6	A.289
1011300000	WSI 6/LD 10-36V DC/AC	A.290
1011320000	DEK 5/6 PLUS MC NE WS	A.7
1011320000	DEK 5/6 PLUS MC NE WS	A.8
1011320000	DEK 5/6 PLUS MC NE WS	A.11
1011320000	DEK 5/6 PLUS MC NE WS	A.12
1011320000	DEK 5/6 PLUS MC NE WS	A.19
1011320000	DEK 5/6 PLUS MC NE WS	A.20
1011320000	DEK 5/6 PLUS MC NE WS	A.21
1011320000	DEK 5/6 PLUS MC NE WS	A.49
1011320000	DEK 5/6 PLUS MC NE WS	A.50
1011320000	DEK 5/6 PLUS MC NE WS	A.51
1011320000	DEK 5/6 PLUS MC NE WS	A.58
1011320000	DEK 5/6 PLUS MC NE WS	A.61
1011320000	DEK 5/6 PLUS MC NE WS	A.62
1011320000	DEK 5/6 PLUS MC NE WS	A.63
1011320000	DEK 5/6 PLUS MC NE WS	A.64
1011320000	DEK 5/6 PLUS MC NE WS	A.69
1011320000	DEK 5/6 PLUS MC NE WS	A.71
1011320000	DEK 5/6 PLUS MC NE WS	A.80
1011320000	DEK 5/6 PLUS MC NE WS	A.81
1011320000	DEK 5/6 PLUS MC NE WS	A.82
1011320000	DEK 5/6 PLUS MC NE WS	A.83
1011320000	DEK 5/6 PLUS MC NE WS	A.85

Order No.	Type	Page
-----------	------	------

1011320000	DEK 5/6 PLUS MC NE WS	B.115
1011320000	DEK 5/6 PLUS MC NE WS	B.116
1011320000	DEK 5/6 PLUS MC NE WS	B.119
1011320000	DEK 5/6 PLUS MC NE WS	B.203
1011320000	DEK 5/6 PLUS MC NE WS	B.204
1011320000	DEK 5/6 PLUS MC NE WS	B.205
1011320000	DEK 5/6 PLUS MC NE WS	B.206
1011320000	DEK 5/6 PLUS MC NE WS	B.207
1011320000	DEK 5/6 PLUS MC NE WS	B.208
1011320000	DEK 5/6 PLUS MC NE WS	B.209
1011320000	DEK 5/6 PLUS MC NE WS	B.210
1011320000	DEK 5/6 PLUS MC NE WS	B.211
1011320000	DEK 5/6 PLUS MC NE WS	B.212
1011320000	DEK 5/6 PLUS MC NE WS	B.213
1011320000	DEK 5/6 PLUS MC NE WS	B.214
1011320000	DEK 5/6 PLUS MC NE WS	B.215
1011320000	DEK 5/6 PLUS MC NE WS	B.253
1011320000	DEK 5/6 PLUS MC NE WS	B.257
1011320000	DEK 5/6 PLUS MC NE WS	B.258
1012200000	WSI 6/LD 30-70V DC/AC	A.290
1012300000	WSI 6/LD 60-150V DC/AC	A.290
1012400000	WSI 6/LD 250AC	A.290
1012600000	WPE 35/AKSC	A.279
1012600000	WPE 35/AKSC	B.33
1014000000	WSI 6/2 GZ/DEF63	A.291
1014100000	WSI 6/2/LD 10-36V DC/AC	A.292
1014200000	WSI 6/2/LD 30-70V DC/AC	A.292
1014300000	WSI 6/2/LD 60-150VDC/AC	A.292
1014400000	WSI 6/2/LD 250AC	A.292
1015800000	WDT 1.5/1 DB/GE	A.314
1015900000	WDT 1.5/2 DB/GE	A.314
1016000000	WDT 1.5/3 DB/GE	A.315
1016200000	WPE 2.5N	A.274
1016400000	WPE 2.5/1.5/ZR	A.273
1016500000	WPE 1.5/ZZ	A.272
1016700000	WTL 6/1	B.162
1016700000	WTL 6/1	B.163
1016900000	WTL 6/1/STB	B.163
1017100000	WTD 6/1	B.162
1017100000	WTD 6/1	B.163
1017900000	WTQ 6/1	B.164
1018100000	WTQ 6/1/STB	B.164
1018600000	WTL 6/3/STB	B.177
1018800000	WTL 6/3	B.176
1018800000	WTL 6/3	B.177
1019000000	WNT 16N 10X3	B.299
1019100000	WPE 16N	A.278
1019700000	WPE 120/150	A.281
1019700000	WPE 120/150	B.35

1020000000

1020000000	WDU 2.5	A.242
1020080000	WDU 2.5 BL	A.242
1020100000	WDU 4	A.245
1020180000	WDU 4 BL	A.245
1020190000	WDU 4 GE/SW	B.262
1020200000	WDU 6	A.248
1020280000	WDU 6 BL	A.248
1020300000	WDU 10	A.250
1020380000	WDU 10 BL	A.250
1020400000	WDU 16	A.252
1020480000	WDU 16 BL	A.252
1020500000	WDU 35	A.254
1020500000	WDU 35	B.26
1020580000	WDU 35 BL	A.254
1020600000	WDU 35/AK	B.27
1020600000	WDU 35/AK	B.25
1020680000	WDU 35/AK BL	A.255
1021500000	WDK 2.5	A.262
1021580000	WDK 2.5 BL	A.262
1021700000	WDK 2.5 FF	A.327
1021800000	WDU 2.5 F 2X2.8	A.326
1021900000	WDU 2.5 FF 2X2.8	A.326
1022300000	WDK 2.5V	A.263
1022380000	WDK 2.5V BL	A.263
1022600000	WDK 2.5 2D 2.A	A.334
1023100000	WDK 2.5/D/3	A.333
1023200000	WDK 2.5/D	A.335
1023300000	WDK 2.5 1D A.2	A.333
1023400000	WDK 2.5 1D A.1	A.332
1023500000	WDK 2.5 2D	A.334
1023600000	WDK 2.5 LD RT 24VDC +-	A.335
1023700000	WDU 2.5N	A.243
1023780000	WDU 2.5N BL	A.243
1023830000	ZTR 6-2	A.193
1024100000	WDU 2.5/TC TYP K	B.194
1024100000	WDU 2.5/TC TYP K	B.195
1024200000	WDU 2.5/TC TYP T	B.194
1024200000	WDU 2.5/TC TYP T	B.195
1024300000	WDU 2.5/TC TYP J	B.194
1024300000	WDU 2.5/TC TYP J	B.195
1024400000	WDU 2.5/TC TYP SR	B.194
1024400000	WDU 2.5/TC TYP SR	B.195
1024500000	WDU 120/150	A.261
1024500000	WDU 120/150	B.30
1024580000	WDU 120/150 BL	A.261
1024580000	WDU 120/150 BL	B.30
1024600000	WDU 70/95	A.261

Order No.	Type	Page
-----------	------	------

1024600000	WDU 70/95	B.29
1024680000	WDU 70/95 BL	A.261
1024680000	WDU 70/95 BL	B.29
1024700000	WDU 2.5/1.5/ZR	A.241
1024780000	WDU 2.5/1.5/ZR BL	A.241
1027000000	WDUL 4/10	A.331
1027300000	WDUL 4/100	A.331
1027400000	WDUL 4/500	A.331
1027410000	WDK 2.5/BLZ/5.08/ZA V	A.329
1027500000	WDUL 4/1K	A.331
1027550000	ZMAK 2.5 690V	A.151
1027550000	ZMAK 2.5 690V	B.95
1027600000	WDUL 4/5K	A.331
1027700000	WDUL 4/10K	A.331
1027800000	WDUL 4/50K	A.331
1027840000	WQL 4 WF10	A.368
1027840000	WQL 4 WF10	A.369
1027840000	WQL 4 WF10	A.378
1027870000	STB 30.5 IH/BR	B.160
1028000000	WDUL 4/500K	A.331
1028300000	WFF 35	A.372
1028380000	WFF 35 BL	A.372
1028400000	WFF 70	A.373
1028480000	WFF 70 BL	A.373
1028500000	WFF 120	A.373
1028580000	WFF 120 BL	A.373
1028600000	WFF 185	A.374
1028680000	WFF 185 BL	A.374
1028700000	WFF 300	A.375
1028800000	WDU 35/ZA	A.254
1028880000	WDU 35/ZA BL	A.254
1028900000	WDU 16/ZA	A.252
1028980000	WDU 16/ZA BL	A.252
1029000000	WDU 35/AK/ZA	A.256
1029100000	WDK 2.5/EX	A.265
1029300000	WFF 35/AH	A.372
1029400000	WFF 70/AH	A.373
1029500000	WFF 120/AH	A.373
1029600000	WFF 185/AH	A.374
1029700000	WFF 300/AH	A.375
1029800000	WDL 2.5/NT/L/PE	B.302
1029900000	WDL 2.5/N/L/PE	B.303

1030000000

1030200000	WDL 2.5/L/L/PE	B.303
1030300000	WDL 2.5/L/L	B.302
1030600000	WDL 2.5/S/NT/L/PE	B.304
1030700000	WDL 2.5/S/N/L/PE	B.305
1031100000	WDL 2.5/S/L/L/PE	B.305
1031200000	WDL 2.5/S/L/L	B.304
1031400000	WDU 1.5/ZZ	A.241
1031480000	WDU 1.5/ZZ BL	A.241
1032880000	WDU 2.5/AP/TC BL TYP K	B.195
1033300000	WDU 2.5/TC TYP E	B.194
1033300000	WDU 2.5/TC TYP E	B.195
1033700000	WDU 2.5/TC TYP B	B.194
1033700000	WDU 2.5/TC TYP B	B.195
1034400000	WDK 2.5/BLZ/5.08/ZA	A.329
1036000000	WPD 4	A.330
1036100000	WDU 16N	A.253
1036180000	WDU 16N BL	A.253
1036300000	WDK 2.5 PE	

Order No.	Type	Page
1061200000	WEW 35/2	B.76
1061200000	WEW 35/2	B.78
1061200000	WEW 35/2	B.80
1061200000	WEW 35/2	B.82
1061200000	WEW 35/2	B.84
1061200000	WEW 35/2	B.86
1061200000	WEW 35/2	B.86
1061200000	WEW 35/2	B.158
1061200000	WEW 35/2	B.160
1061200000	WEW 35/2	B.161
1061200000	WEW 35/2	B.162
1061200000	WEW 35/2	B.166
1061200000	WEW 35/2	B.167
1061200000	WEW 35/2	B.168
1061200000	WEW 35/2	B.169
1061200000	WEW 35/2	B.172
1061200000	WEW 35/2	B.173
1061200000	WEW 35/2	B.174
1061200000	WEW 35/2	B.175
1061200000	WEW 35/2	B.176
1061200000	WEW 35/2	B.177
1061200000	WEW 35/2	B.194
1061200000	WEW 35/2	B.203
1061200000	WEW 35/2	B.204
1061200000	WEW 35/2	B.205
1061200000	WEW 35/2	B.206
1061200000	WEW 35/2	B.207
1061200000	WEW 35/2	B.208
1061200000	WEW 35/2	B.209
1061200000	WEW 35/2	B.210
1061200000	WEW 35/2	B.211
1061200000	WEW 35/2	B.212
1061200000	WEW 35/2	B.213
1061200000	WEW 35/2	B.214
1061200000	WEW 35/2	B.215
1061200000	WEW 35/2	B.220
1061200000	WEW 35/2	B.222
1061200000	WEW 35/2	B.223
1061200000	WEW 35/2	B.255
1061200000	WEW 35/2	B.262
1061200000	WEW 35/2	B.263
1061200000	WEW 35/2	B.264
1061200000	WEW 35/2	B.298
1061200000	WEW 35/2	B.299
1061200000	WEW 35/2	B.300
1061200000	WEW 35/2	B.302
1061200000	WEW 35/2	B.303
1061200000	WEW 35/2	B.304
1061200000	WEW 35/2	B.305
1061200000	WEW 35/2	C.13
1061200000	WEW 35/2	C.21
1061210000	WEW 35/2 SW	A.316
1061210000	WEW 35/2 SW	C.13
1061210000	WEW 35/2 SW	C.21
1062060000	WTA 5/10	A.355
1062660000	WQV 6/5	A.348
1062660000	WQV 6/5	B.171
1062660000	WQV 6/5	B.172
1062660000	WQV 6/5	B.174
1062660000	WQV 6/5	B.176
1062670000	WQV 6/6	A.348
1062680000	WQV 6/7	A.348
1062680000	WQV 6/7	B.171
1062680000	WAD 27 M. BL	A.261
1062680000	WAD 27 M. BL	B.29
1062680000	WAD 27 M. BL	B.30
1062960000	WAD 27 NEUTRAL	A.261
1062960000	WAD 27 NEUTRAL	B.29
1062960000	WAD 27 NEUTRAL	B.30
1063300000	WQV 120/2	A.261
1063300000	WQV 120/2	A.349
1063300000	WQV 120/2	B.30
1063400000	WQV 120/3	A.261
1063400000	WQV 120/3	A.349
1063400000	WQV 120/3	B.30
1063500000	WQV 70/95/2	A.261
1063500000	WQV 70/95/2	A.349
1063500000	WQV 70/95/2	B.29
1063600000	WQV 70/95/3	A.261
1063600000	WQV 70/95/3	A.349
1063600000	WQV 70/95/3	B.29
1063900000	WQV 162.5	A.352
1064000000	WQV 164/6	A.351
1064100000	WQV 352.5	A.351
1064200000	WQV 354/6	A.352
1064460000	WAH 35	A.372
1064460000	WAH 35	A.379
1064560000	WAH 70 BE	A.373
1064560000	WAH 70 BE	A.379
1064660000	WAH 120	A.373
1064660000	WAH 120	A.374
1064660000	WAH 120	A.379
1064760000	WAH 185/300 BE	A.374
1064760000	WAH 185/300 BE	A.375
1064760000	WAH 185/300 BE	A.379
1064900000	WQL 2 WFF35	A.372
1064900000	WQL 2 WFF35	A.378
1065000000	WQL 2 WFF70	A.373
1065000000	WQL 2 WFF70	A.378

Order No.	Type	Page
1065100000	WQL 2 WFF120	A.373
1065100000	WQL 2 WFF120	A.374
1065100000	WQL 2 WFF120	A.378
1065200000	WQL 2 WFF185	A.374
1065200000	WQL 2 WFF185	A.375
1065200000	WQL 2 WFF185	A.378
1065300000	WQL 2 WFF300	A.375
1065300000	WQL 2 WFF300	A.378
1065400000	WQL 3 WFF35	A.372
1065400000	WQL 3 WFF35	A.378
1065500000	WQL 3 WFF70	A.373
1065500000	WQL 3 WFF70	A.378
1065600000	WQL 3 WFF120	A.373
1065600000	WQL 3 WFF120	A.374
1065600000	WQL 3 WFF120	A.378
1065700000	WQL 3 WFF185	A.374
1065700000	WQL 3 WFF185	A.375
1065700000	WQL 3 WFF185	A.378
1065800000	WQL 3 WFF300	A.375
1065800000	WQL 3 WFF300	A.378
1066000000	WZAD 70/95	A.261
1066000000	WZAD 70/95	B.29
1066100000	WZAD120	A.261
1066100000	WZAD120	B.30
1066200000	WZAF 70	A.367
1066200000	WZAF 70	A.368
1066200000	WZAF 70	A.370
1066200000	WZAF 70	A.373
1066300000	WZAF 120	A.368
1066300000	WZAF 120	A.369
1066300000	WZAF 120	A.371
1066300000	WZAF 120	A.373
1066300000	WZAF 120	A.374
1066400000	WZAF 185	A.369
1066400000	WZAF 185	A.374
1066400000	WZAF 185	A.375
1066500000	WZAF 300	A.375
1066500000	WZAF 300	A.378
1067100000	WTW WFF35	A.372
1067100000	WTW WFF35	A.378
1067200000	WTW WFF70	A.373
1067200000	WTW WFF70	A.378
1067300000	WTW WFF120	A.373
1067300000	WTW WFF120	A.378
1067400000	WTW WFF185/300	A.374
1067400000	WTW WFF185/300	A.375
1067400000	WTW WFF185/300	A.378
1067600000	WEW 32/1	C.21
1067700000	WAP WDL2.5/S	B.304
1067700000	WAP WDL2.5/S	B.305
1067800000	WAP WDL2.5	B.302
1067800000	WAP WDL2.5	B.303
1067980000	WHP WDL2.5/S/BL	B.302
1067980000	WHP WDL2.5/S/BL	B.303
1067980000	WHP WDL2.5/S/BL	B.304
1067980000	WHP WDL2.5/S/BL	B.305
1068000000	WQV 35-10	A.351
1068160000	WBB WDU1.5/BL...	A.328
1068260000	WBB ZA WDU1.5/BL 10/10	A.328
1068300000	WAP WTL6/1	B.162
1068300000	WAP WTL6/1	B.163
1068300000	WAP WTL6/1	B.164
1068400000	WTW WTL6/1 DB	B.163
1068400000	WTW WTL6/1 DB	B.164
1068400000	WTW WTL6/1 DB	B.167
1068400000	WTW WTL6/1 DB	B.168
1068400000	WTW WTL6/1 DB	B.169
1068700000	WSH 1	B.242

1070000000

1070000000	WAP WDK2.5/BLZ/O.ZA	A.329
1070100000	WAP WDK2.5/BLZ/M.ZA	A.329
1070500000	WZAF 35	A.367
1070500000	WZAF 35	A.370
1070500000	WZAF 35	A.372
1071000000	STB 21.6/H/DB WTL6/3	B.176
1071010000	STB 21.6/H/GE WTL6/3	B.156
1071010000	STB 21.6/H/GE WTL6/3	B.157
1071010000	STB 21.6/H/GE WTL6/3	B.176
1071010000	STB 21.6/H/GE WTL6/3	B.177
1071020000	STB 21.6/H/GN WTL6/3	B.156
1071020000	STB 21.6/H/GN WTL6/3	B.157
1071020000	STB 21.6/H/GN WTL6/3	B.176
1071020000	STB 21.6/H/GN WTL6/3	B.177
1071030000	STB 21.6/H/VI WTL6/3	B.156
1071030000	STB 21.6/H/VI WTL6/3	B.157
1071030000	STB 21.6/H/VI WTL6/3	B.176
1071030000	STB 21.6/H/VI WTL6/3	B.177
1071040000	STB 21.6/H/SW WTL6/3	B.156
1071040000	STB 21.6/H/SW WTL6/3	B.176
1071080000	STB 21.6/H/BL WTL6/3	B.156
1071080000	STB 21.6/H/BL WTL6/3	B.157
1071080000	STB 21.6/H/BL WTL6/3	B.176
1071080000	STB 21.6/H/BL WTL6/3	B.177
1071100000	ZR WP04 DB	A.330
1071200000	SSCH 7.3X1.2X1000	A.330
1071200000	SSCH 7.3X1.2X1000	C.12
1071360000	WQV 16N-PEN BL	A.278

Order No.	Type	Page
1071360000	WQV 16N-PEN BL	A.357
1071500000	Q 2 WDL2.5S	A.350
1071500000	Q 2 WDL2.5S	B.302
1071500000	Q 2 WDL2.5S	B.303
1071500000	Q 2 WDL2.5S	B.304
1071500000	Q 2 WDL2.5S	B.305
1071600000	Q 3 WDL2.5S	A.350
1071600000	Q 3 WDL2.5S	B.302
1071600000	Q 3 WDL2.5S	B.303
1071600000	Q 3 WDL2.5S	B.304
1071600000	Q 3 WDL2.5S	B.305
1071680000	TS 35X15/LL 2M/ST/ZN/0	C.19
1071690000	TS 35X7.5/LL/6X18 2M/0	C.18
1071700000	Q 4 WDL2.5S	A.350
1071700000	Q 4 WDL2.5S	B.302
1071700000	Q 4 WDL2.5S	B.303
1071700000	Q 4 WDL2.5S	B.304
1071700000	Q 4 WDL2.5S	B.305
1071800000	Q 10 WDL2.5S	A.350
1071800000	Q 10 WDL2.5S	B.302
1071800000	Q 10 WDL2.5S	B.303
1071800000	Q 10 WDL2.5S	B.304
1071800000	Q 10 WDL2.5S	B.305
1071900000	EW 15/2	C.21
1072000000	WAD 4 GE BED	A.241
1072000000	WAD 4 GE BED	A.243
1072000000	WAD 4 GE BED	A.244
1072000000	WAD 4 GE BED	A.246
1072000000	WAD 4 GE BED	A.262
1072000000	WAD 4 GE BED	A.263
1072000000	WAD 4 GE BED	A.264
1072000000	WAD 4 GE BED	A.265
1072000000	WAD 4 GE BED	A.266
1072000000	WAD 4 GE BED	A.267
1072000000	WAD 4 GE BED	A.268
1072000000	WAD 4 GE BED	A.269
1072000000	WAD 4 GE BED	A.270
1072000000	WAD 4 WS	A.241
1072100000	WAD 4 WS	A.243
1072100000	WAD 4 WS	A.244
1072100000	WAD 4 WS	A.246
1072100000	WAD 4 WS	A.262
1072100000	WAD 4 WS	A.265
1072100000	WAD 4 WS	A.266
1072100000	WAD 4 WS	A.267
1072100000	WAD 4 WS	A.268
1072100000	WAD 4 WS	A.269
1072100000	WAD 4 WS	A.270
1072100000	WAD 4 WS	A.271
1072100000	WAD 4 WS	A.272
1072100000	WAD 4 WS	A.273
1072100000	WAD 4 WS	A.274
1072100000	WAD 4 WS	A.275
1072100000	WAD 4 WS	A.276
1072100000	WAD 4 WS	A.277
1072100000	WAD 4 WS	A.278
1072100000	WAD 4 WS	A.279
1072100000	WAD 4 WS	A.280
1072100000	WAD 4 WS	A.281
1072100000	WAD 4 WS	A.282
1072100000	WAD 4 WS	A.283
1072100000	WAD 4 WS	A.284
1072100000	WAD 4 WS	A.285
1072100000	WAD 4 WS	A.286
1072100000	WAD 4 WS	A.287
1072100000	WAD 4 WS	A.288
1072100000	WAD 4 WS	A.289
1072100000	WAD 4 WS	A.290
1072100000	WAD 4 WS	A.291
1072100000	WAD 4 WS	A.292
1072100000	WAD 4 WS	A.293
1072100000	WAD 4 WS	A.294
1072100000	WAD 4 WS	A.295
1072100000	WAD 4 WS	A.296
1072100000	WAD 4 WS	A.297
1072100000	WAD 4 WS	A.298
1072100000	WAD 4 WS	A.299
1072100000	WAD 4 WS	A.300
1072100000	WAD 4 WS	A.301
1072100000	WAD 4 WS	A.302
1072100000	WAD 4 WS	A.303
1072100000	WAD 4 WS	A.304
1072100000	WAD 4 WS	A.305
1072100000	WAD 4 WS	A.306
1072100000	WAD 4 WS	A.307
1072100000	WAD 4 WS	A.308
1072100000	WAD 4 WS	A.309
1072100000	WAD 4 WS	A.310
1072100000	WAD 4 WS	A.311
1072100000	WAD 4 WS	A.312
1072100000	WAD 4 WS	A.313
1072100000	WAD 4 WS	A.314
1072100000		

Table with columns: Order No., Type, Page. Contains order details for items 1162610000 to 1167910000.

1170000000

Table with columns: Order No., Type, Page. Contains order details for items 1173540000 to 1173930000.

1180000000

Table with columns: Order No., Type, Page. Contains order details for items 1186630000 to 1186720000.

Table with columns: Order No., Type, Page. Contains order details for items 1186730000 to 1186780000.

1190000000

Table with columns: Order No., Type, Page. Contains order details for item 1193450000.

1200000000

Table with columns: Order No., Type, Page. Contains order details for items 1208920000 to 1208970000.

1210000000

Table with columns: Order No., Type, Page. Contains order details for items 1210410000 to 1216230000.

1220000000

Table with columns: Order No., Type, Page. Contains order details for items 1227850000 to 1227890000.

1230000000

Table with columns: Order No., Type, Page. Contains order details for items 1230050000 to 1238930000.

1240000000

Table with columns: Order No., Type, Page. Contains order details for items 1246990000 to 1247430000.

1250000000

Table with columns: Order No., Type, Page. Contains order details for items 1252490000 to 1255010000.

Table with columns: Order No., Type, Page. Contains order details for items 1265990000 to 1267800000.

1260000000

Table with columns: Order No., Type, Page. Contains order details for items 1267810000 to 1269070000.

1270000000

Table with columns: Order No., Type, Page. Contains order details for items 1270040000 to 1278940000.

1280000000

Table with columns: Order No., Type, Page. Contains order details for items 1283470000 to 1286600000.

1280000000

Table with columns: Order No., Type, Page. Contains order details for items 1283470000 to 1286600000.

Table with columns: Order No., Type, Page. Contains order details for items 1295550000 to 1301640000.

1290000000

Table with columns: Order No., Type, Page. Contains order details for items 1303360000 to 1305330000.

1310000000

Table with columns: Order No., Type, Page. Contains order details for items 1312440000 to 1319900000.

1340000000

Table with columns: Order No., Type, Page. Contains order details for items 1340870000 to 1348970000.

1350000000

Table with columns: Order No., Type, Page. Contains order details for items 1350990000 to 1356790000.

1360000000

Table with columns: Order No., Type, Page. Contains order details for item 1368700000.

1370000000

Table with columns: Order No., Type, Page. Contains order details for item 1378160000.

1390000000

Table with columns: Order No., Type, Page. Contains order details for items 1393020000 to 1397000000.

Order No.	Type	Page
-----------	------	------

1399800000	Q 20 DLI	A.350
------------	----------	-------

1400000000

1402830000	KLBU 3-8 RCT S35	B.246
1403050000	KLBU 10-20 RCT S27	B.245
1403060000	KLBU 4-13.5 RCT S27	B.245
1403070000	KLBU 3-8 RCT S27	B.246
1403080000	KLBU 10-20 RCT S35	B.247
1403090000	KLBU 4-13.5 RCT S35	B.247

1410000000

1412950000	WDU 2.5 HV	A.243
1412960000	WDU 4 HV	A.245
1412970000	WDU 6 HV	A.248
1415470000	WDK 10 PE	A.283
1415480000	WDK 10 DUPE	A.270
1415510000	WDK 10 L	A.268
1415520000	WDK 10 DU-N	A.269
1415530000	WDK 10 SET LS	A.271
1415530000	WDK 10 SET LS	B.96
1415540000	WDK 10 SET BCD	A.270
1415540000	WDK 10 SET BCD	B.96

1430000000

1430760000	ADP 4/1000	C.23
------------	------------	------

1460000000

1460580000	GZ 0.5A/F	A.191
1460580000	GZ 0.5A/F	A.304
1460590000	GZ 1.0A/F	A.191
1460590000	GZ 1.0A/F	A.304
1460600000	GZ 2.0A/F	A.191
1460600000	GZ 2.0A/F	A.304
1460610000	GZ 3.0A/F	A.191
1460610000	GZ 3.0A/F	A.304
1460620000	GZ 5.0A/F	A.191
1460620000	GZ 5.0A/F	A.304
1460630000	GZ 7.0A/F	A.191
1460630000	GZ 7.0A/F	A.304
1460640000	GZ 10.0A/F	A.191
1460640000	GZ 10.0A/F	A.304
1460650000	GZ 12.5A/F	A.191
1460650000	GZ 12.5A/F	A.304
1469080000	WDV 50N/5/3/1	A.348
1469090000	WDV 95N/120N/5/3/1	A.349

1510000000

1513640000	APG 2.5/2	A.84
1513650000	APG 2.5/3	A.84
1513670000	APG 2.5/4	A.84
1513680000	APG 2.5/5	A.84
1513690000	APG 2.5/6	A.84
1513700000	APG 2.5/7	A.84
1513720000	APG 2.5/1	A.76
1513720000	APG 2.5/1	A.77
1513720000	APG 2.5/1	A.78
1513720000	APG 2.5/1	A.79
1513720000	APG 2.5/1	A.84
1513730000	APG 2.5/8	A.84
1513740000	APG 2.5/9	A.84
1513770000	APG 2.5/10	A.76
1513770000	APG 2.5/10	A.77
1513770000	APG 2.5/10	A.78
1513770000	APG 2.5/10	A.79
1513770000	APG 2.5/10	A.84
1513780000	APG 2.5/3-BG-BL-GN	A.84
1513790000	APG 2.5/4-3BG-GN	A.86
1513820000	APG 2.5/3-BG-BL-GN	A.84
1513830000	APG 2.5 L	A.76
1513830000	APG 2.5 L	A.77
1513830000	APG 2.5 L	A.78
1513830000	APG 2.5 L	A.79
1513830000	APG 2.5 L	A.88
1513840000	APG 2.5 L BL	A.88
1513850000	APG 2.5 L GN	A.88
1513870000	APGTB 2.5 PE 2C/1	A.76
1513870000	APGTB 2.5 PE 2C/1	A.105
1513880000	APG 2.5 MI	A.76
1513880000	APG 2.5 MI	A.77
1513880000	APG 2.5 MI	A.78
1513880000	APG 2.5 MI	A.79
1513880000	APG 2.5 MI	A.88
1513890000	APGTB 2.5 PE 3C/1	A.77
1513890000	APGTB 2.5 PE 3C/1	A.105
1513900000	APG 2.5 MI BL	A.88
1513920000	APGTB 2.5 PE 4C/2	A.78
1513920000	APGTB 2.5 PE 4C/2	A.105
1513930000	APG 2.5 MI GN	A.88
1513940000	APG 2.5 R	A.76
1513940000	APG 2.5 R	A.77
1513940000	APG 2.5 R	A.78
1513940000	APG 2.5 R	A.79
1513940000	APG 2.5 R	A.88
1513950000	APG 2.5 R BL	A.88

Order No.	Type	Page
-----------	------	------

1513970000	APGTB 2.5 FT 2C/1	A.76
1513970000	APGTB 2.5 FT 2C/1	A.105
1513980000	APG 2.5 R GN	A.88
1513990000	APGTB 2.5 FT 2C/1 BL	A.76
1514000000	APGTB 2.5 FT 3C/1	A.77
1514000000	APGTB 2.5 FT 3C/1	A.105
1514020000	APGTB 2.5 FT 3C/1 BL	A.77
1514030000	APGTB 2.5 FT 4C/2	A.77
1514030000	APGTB 2.5 FT 4C/2	A.105
1514040000	APGTB 2.5 FT 4C/2 BL	A.77
1514400000	AEP 2C 2.5	A.17
1514400000	AEP 2C 2.5	A.47
1514400000	AEP 2C 2.5	A.76
1514400000	AEP 2C 2.5	A.103
1514400000	AEP 2C 2.5	B.252
1514420000	AEP 2C 2.5 BL	A.157
1514420000	AEP 2C 2.5 BL	A.76
1514420000	AEP 2C 2.5 BL	A.103
1514450000	AEP PGTB 2.5 4C/2	A.77
1514450000	AEP PGTB 2.5 4C/2	A.78
1514470000	AEP PGTB 2.5 4C/2 BL	A.77
1514490000	APGCE	A.84
1514490000	APGCE	A.85
1514490000	APGCE	A.86
1514490000	APGCE	A.89
1514490000	APGCE	A.320
1514490000	APGCE	A.321
1514490000	APGCE	A.324
1514490000	APGCE	B.142
1514490000	APGCE	B.147
1514500000	APGPC 2.5	A.84
1514500000	APGPC 2.5	A.86
1514500000	APGPC 2.5	A.89
1518300000	KDKS 1PE/LIC 10-36V AC/DC	A.302
1518330000	KDKS 1PE/LIC 30-70V AC/DC	A.302
1518340000	KDKS 1PE/LIC 60-150V AC/DC	A.302
1518370000	KDKS 1PE/LIC 100-250V AC/DC	A.302

1520000000

1521510000	AEP 3C 2.5	A.18
1521510000	AEP 3C 2.5	A.48
1521510000	AEP 3C 2.5	A.77
1521520000	AEP 3C 2.5 BL	A.18
1521520000	AEP 3C 2.5 BL	A.77
1521530000	AEP 4C 2.5	A.19
1521530000	AEP 4C 2.5	A.49
1521530000	AEP 4C 2.5	A.66
1521530000	AEP 4C 2.5	A.67
1521540000	A4C 2.5 PE	A.49
1521540000	A4C 2.5 PE	A.105
1521640000	AEP 4C 2.5 BL	A.19
1521640000	AEP 4C 2.5 BL	A.66
1521640000	AEP 4C 2.5 BL	A.67
1521670000	A3C 2.5 PE	A.48
1521670000	A3C 2.5 PE	A.60
1521670000	A3C 2.5 PE	A.105
1521680000	A2C 2.5 PE	A.47
1521680000	A2C 2.5 PE	A.105
1521690000	A4C 2.5	A.19
1521690000	A4C 2.5	A.105
1521690000	A4C 2.5	A.118
1521700000	A4C 2.5 BL	A.19
1521700000	A4C 2.5 BL	A.118
1521710000	A4C 2.5 RD	A.118
1521720000	A4C 2.5 DR	A.118
1521730000	A4C 2.5 YL	A.118
1521740000	A3C 2.5	A.18
1521740000	A3C 2.5	A.60
1521740000	A3C 2.5	A.105
1521740000	A3C 2.5	A.118
1521770000	A4C 2.5 GN	A.118
1521780000	A3C 2.5 BL	A.118
1521780000	A3C 2.5 BL	A.118
1521790000	A4C 2.5 WT	A.118
1521800000	A3C 2.5 RD	A.118
1521820000	A4C 2.5 BK	A.118
1521830000	A3C 2.5 DR	A.118
1521840000	A3C 2.5 YL	A.118
1521850000	A2C 2.5	A.17
1521850000	A2C 2.5	A.103
1521850000	A2C 2.5	A.105
1521850000	A2C 2.5	A.118
1521870000	A3C 2.5 GN	A.118
1521880000	A2C 2.5 BL	A.17
1521880000	A2C 2.5 BL	A.103
1521880000	A2C 2.5 BL	A.118
1521890000	A3C 2.5 WT	A.118
1521900000	A2C 2.5 RD	A.118
1521920000	A3C 2.5 BK	A.118
1521930000	A2C 2.5 DR	A.118
1521940000	A2C 2.5 YL	A.118
1521950000	A2C 2.5 GN	A.118
1521970000	A2C 2.5 WT	A.118
1521980000	A2C 2.5 BK	A.118
1527540000	ZOV 2.5N/2	A.6
1527540000	ZOV 2.5N/2	A.7
1527540000	ZOV 2.5N/2	A.8
1527540000	ZOV 2.5N/2	A.9

Order No.	Type	Page
-----------	------	------

1527540000	ZOV 2.5N/2	A.17
1527540000	ZOV 2.5N/2	A.18
1527540000	ZOV 2.5N/2	A.19
1527540000	ZOV 2.5N/2	A.24
1527540000	ZOV 2.5N/2	A.27
1527540000	ZOV 2.5N/2	A.34
1527540000	ZOV 2.5N/2	A.35
1527540000	ZOV 2.5N/2	A.36
1527540000	ZOV 2.5N/2	A.37
1527540000	ZOV 2.5N/2	A.42
1527540000	ZOV 2.5N/2	A.43
1527540000	ZOV 2.5N/2	A.44
1527540000	ZOV 2.5N/2	A.60
1527540000	ZOV 2.5N/2	A.66
1527540000	ZOV 2.5N/2	A.67
1527540000	ZOV 2.5N/2	A.68
1527540000	ZOV 2.5N/2	A.69
1527540000	ZOV 2.5N/2	A.70
1527540000	ZOV 2.5N/2	A.76
1527540000	ZOV 2.5N/2	A.77
1527540000	ZOV 2.5N/2	A.78
1527540000	ZOV 2.5N/2	A.79
1527540000	ZOV 2.5N/2	A.92
1527540000	ZOV 2.5N/2	A.93
1527540000	ZOV 2.5N/2	A.94
1527540000	ZOV 2.5N/2	A.95
1527540000	ZOV 2.5N/2	A.103
1527540000	ZOV 2.5N/2	A.110
1527540000	ZOV 2.5N/2	A.125
1527540000	ZOV 2.5N/2	A.194
1527540000	ZOV 2.5N/2	A.196
1527540000	ZOV 2.5N/2	A.197
1527540000	ZOV 2.5N/2	A.202
1527540000	ZOV 2.5N/2	A.203
1527540000	ZOV 2.5N/2	A.205
1527540000	ZOV 2.5N/2	A.209
1527540000	ZOV 2.5N/2	A.241
1527540000	ZOV 2.5N/2	A.242
1527540000	ZOV 2.5N/2	A.243
1527540000	ZOV 2.5N/2	A.263
1527540000	ZOV 2.5N/2	A.264
1527540000	ZOV 2.5N/2	A.265
1527540000	ZOV 2.5N/2	A.299
1527540000	ZOV 2.5N/2	A.308
1527540000	ZOV 2.5N/2	A.309
1527540000	ZOV 2.5N/2	A.320
1527540000	ZOV 2.5N/2	B.221
1527540000	ZOV 2.5N/2	B.222
1527540000	ZOV 2.5N/2	B.223
1527540000	ZOV 2.5N/2	B.224
1527540000	ZOV 2.5N/2	B.225
1527540000	ZOV 2.5N/2	B.256
1527540000	ZOV 2.5N/2	B.257
1527540000	ZOV 2.5N/2	B.262
1527540000	ZOV 2.5N/2	B.278
1527540000	ZOV 2.5N/2	B.284
1527540000	ZOV 2.5N/2	B.285
1527540000	ZOV 2.5N/2	B.286
1527540000	ZOV 2.5N/2	B.287
1527540000	ZOV 2.5N/2	B.290
1527540000	ZOV 2.5N/2	B.291
1527540000	ZOV 2.5N/2	B.292
1527540000	ZOV 2.5N/2	B.293
1527590000	ZOV 2.5N/4	A.110
1527590		

Order No.	Type	Page
1633220000	ZQS 2.5/4	A.230
1633230000	ZQS 2.5/5	A.230
1633280000	VOB 1.5/50 BL	A.271
1633280000	VOB 1.5/50 BL	A.316
1633280000	VOB 1.5/50 BL	B.97
1633280000	VOB 1.5/50 BL	B.190
1633280000	VOB 1.5/50 BL	B.191
1633280000	VOB 1.5/50 BL	B.192
1633280000	VOB 1.5/50 BL	B.193
1633290000	VOB 1.5/50 RT	A.271
1633290000	VOB 1.5/50 RT	A.316
1633290000	VOB 1.5/50 RT	B.97
1633290000	VOB 1.5/50 RT	B.190
1633290000	VOB 1.5/50 RT	B.191
1633290000	VOB 1.5/50 RT	B.192
1633290000	VOB 1.5/50 RT	B.193
1635000000	WS 10/5 MC NE WS	A.122
1635000000	WS 10/5 MC NE WS	A.123
1635000000	WS 10/5 MC NE WS	A.124
1635000000	WS 10/5 MC NE WS	A.125
1635000000	WS 10/5 MC NE WS	A.130
1635000000	WS 10/5 MC NE WS	A.131
1635000000	WS 10/5 MC NE WS	A.152
1635000000	WS 10/5 MC NE WS	A.153
1635000000	WS 10/5 MC NE WS	A.154
1635000000	WS 10/5 MC NE WS	A.158
1635000000	WS 10/5 MC NE WS	A.159
1635000000	WS 10/5 MC NE WS	A.160
1635000000	WS 10/5 MC NE WS	A.161
1635000000	WS 10/5 MC NE WS	A.162
1635000000	WS 10/5 MC NE WS	A.163
1635000000	WS 10/5 MC NE WS	A.169
1635000000	WS 10/5 MC NE WS	A.177
1635000000	WS 10/5 MC NE WS	A.178
1635000000	WS 10/5 MC NE WS	A.179
1635000000	WS 10/5 MC NE WS	A.180
1635000000	WS 10/5 MC NE WS	A.181
1635000000	WS 10/5 MC NE WS	A.182
1635000000	WS 10/5 MC NE WS	A.184
1635000000	WS 10/5 MC NE WS	A.186
1635000000	WS 10/5 MC NE WS	A.187
1635000000	WS 10/5 MC NE WS	A.192
1635000000	WS 10/5 MC NE WS	A.199
1635000000	WS 10/5 MC NE WS	A.200
1635000000	WS 10/5 MC NE WS	A.204
1635000000	WS 10/5 MC NE WS	A.208
1635000000	WS 10/5 MC NE WS	A.209
1635000000	WS 10/5 MC NE WS	A.216
1635000000	WS 10/5 MC NE WS	A.217
1635000000	WS 10/5 MC NE WS	A.320
1635000000	WS 10/5 MC NE WS	A.321
1635000000	WS 10/5 MC NE WS	B.221
1635000000	WS 10/5 MC NE WS	B.222
1635000000	WS 10/5 MC NE WS	B.223
1635000000	WS 10/5 MC NE WS	B.224
1635000000	WS 10/5 MC NE WS	B.225
1635120000	VOB 1.5/50 SW	A.271
1635120000	VOB 1.5/50 SW	A.316
1635120000	VOB 1.5/50 SW	B.97
1635120000	VOB 1.5/50 SW	B.190
1635120000	VOB 1.5/50 SW	B.191
1635120000	VOB 1.5/50 SW	B.192
1635120000	VOB 1.5/50 SW	B.193
1636560000	WQV 16N/2	A.253
1636560000	WQV 16N/2	A.349
1636560000	WQV 16N/2	B.263
1636570000	WQV 16N/3	A.349
1636580000	WQV 16N/4	A.349
1636580000	WQV 16N/4	A.253
1636580000	WQV 16N/4	B.263
1636640000	ZRH 4/1 WS	A.132
1636640000	ZRH 4/1 WS	A.133
1636640000	ZRH 4/1 WS	A.163
1636640000	ZRH 4/1 WS	A.164
1636640000	ZRH 4/1 WS	A.169
1636640000	ZRH 4/1 WS	A.170
1636640000	ZRH 4/1 WS	A.235

1640000000

1640740000	WS 8/5 MC NE WS	A.262
1640740000	WS 8/5 MC NE WS	A.263
1640740000	WS 8/5 MC NE WS	A.264
1640740000	WS 8/5 MC NE WS	A.265
1640740000	WS 8/5 MC NE WS	A.282
1640740000	WS 8/5 MC NE WS	A.314
1640740000	WS 8/5 MC NE WS	A.315
1640740000	WS 8/5 MC NE WS	A.316
1640740000	WS 8/5 MC NE WS	A.318
1640740000	WS 8/5 MC NE WS	A.319
1640740000	WS 8/5 MC NE WS	A.327
1640740000	WS 8/5 MC NE WS	A.332
1640740000	WS 8/5 MC NE WS	A.333
1640740000	WS 8/5 MC NE WS	A.334
1640740000	WS 8/5 MC NE WS	A.335
1640740000	WS 8/5 MC NE WS	B.302
1640740000	WS 8/5 MC NE WS	B.303
1640740000	WS 8/5 MC NE WS	B.304
1640740000	WS 8/5 MC NE WS	B.305

Order No.	Type	Page
1649300000	ZVL 1.5	B.189
1649540000	ZAP/TW ZIA1.5/3L	B.188
1649550000	ZAP/TW ZIA1.5/4L	B.189

1650000000

1650210000	WTA 7 WS16	A.354
1650340000	ZDU 2.5/2X2AN/D+	A.217
1650350000	ZDU 2.5/2X2AN/D-	A.217
1650360000	ZVL 1.5 BL	B.189
1650370000	ZVL 1.5 BR	B.189
1651970000	ZVL 1.5/PE GN/GE BED	B.189
1651980000	ZIA 1.5/3L-IS	B.188
1651990000	ZIA 1.5/3L-IS/LD-RT	B.188
1652000000	ZIA 1.5/3L-PE	B.188
1652010000	ZIA 1.5/4L-IS	B.189
1652020000	ZIA 1.5/4L-IS/LD	B.189
1652030000	ZIA 1.5/4L-PE	B.189
1654050000	ZTA 3 ZDU6	A.129
1654050000	ZTA 3 ZDU6	A.133
1654050000	ZTA 3 ZDU6	A.165
1654050000	ZTA 3 ZDU6	A.232

1670000000

1670360000	QVSK 2 SAKT1	B.170
1674300000	ZDK 2.5	A.146
1674650000	ZAP/TW ZPV1.5	B.188
1674730000	ZAP/TW ZDK2.5	A.146
1674730000	ZAP/TW ZDK2.5	A.147
1674730000	ZAP/TW ZDK2.5	A.174
1674730000	ZAP/TW ZDK2.5	A.219
1674730000	ZAP/TW ZDK2.5	A.220
1674730000	ZAP/TW ZDK2.5	A.221
1674730000	ZAP/TW ZDK2.5	A.222
1674730000	ZAP/TW ZDK2.5	A.223
1675350000	KLBUE 2X2.6	B.236
1676610000	BZT ZVL1.5	B.189
1676620000	BZT ZVL1.5/D ZA	B.189
1676630000	ZPV 1.5	B.188
1677120000	ZQB 2.5-2	A.122
1677120000	ZQB 2.5-2	A.123
1677120000	ZQB 2.5-2	A.124
1677120000	ZQB 2.5-2	A.139
1677120000	ZQB 2.5-2	A.230
1678630000	ZDK 2.5 BL	A.146
1678680000	ZST	A.237
1678800000	ZRH 1.5H/2	A.138
1678800000	ZRH 1.5H/2	A.139
1678800000	ZRH 1.5H/2	A.142
1678800000	ZRH 1.5H/2	A.143
1678800000	ZRH 1.5H/2	A.146
1678800000	ZRH 1.5H/2	A.147
1678800000	ZRH 1.5H/2	A.148
1678800000	ZRH 1.5H/2	A.149
1678800000	ZRH 1.5H/2	A.151
1678800000	ZRH 1.5H/2	A.152
1678800000	ZRH 1.5H/2	A.153
1678800000	ZRH 1.5H/2	A.154
1678800000	ZRH 1.5H/2	A.158
1678800000	ZRH 1.5H/2	A.159
1678800000	ZRH 1.5H/2	A.168
1678800000	ZRH 1.5H/2	A.169
1678800000	ZRH 1.5H/2	A.172
1678800000	ZRH 1.5H/2	A.173
1678800000	ZRH 1.5H/2	A.174
1678800000	ZRH 1.5H/2	A.175
1678800000	ZRH 1.5H/2	A.176
1678800000	ZRH 1.5H/2	A.235
1678810000	ZRH 1.5H/1	B.95
1678810000	ZRH 1.5H/1	A.138
1678810000	ZRH 1.5H/1	A.139
1678810000	ZRH 1.5H/1	A.142
1678810000	ZRH 1.5H/1	A.143
1678810000	ZRH 1.5H/1	A.146
1678810000	ZRH 1.5H/1	A.147
1678810000	ZRH 1.5H/1	A.148
1678810000	ZRH 1.5H/1	A.149
1678810000	ZRH 1.5H/1	A.151
1678810000	ZRH 1.5H/1	A.152
1678810000	ZRH 1.5H/1	A.153
1678810000	ZRH 1.5H/1	A.154
1678810000	ZRH 1.5H/1	A.158
1678810000	ZRH 1.5H/1	A.159
1678810000	ZRH 1.5H/1	A.168
1678810000	ZRH 1.5H/1	A.172
1678810000	ZRH 1.5H/1	A.173
1678810000	ZRH 1.5H/1	A.174
1678810000	ZRH 1.5H/1	A.175
1678810000	ZRH 1.5H/1	A.176
1678810000	ZRH 1.5H/1	A.235
1678810000	ZRH 1.5H/1	B.95

1680000000

1688110000	ZTA 4	A.138
1688110000	ZTA 4	A.139
1688110000	ZTA 4	A.148

Order No.	Type	Page
1688110000	ZTA 4	A.149
1688110000	ZTA 4	A.152
1688110000	ZTA 4	A.154
1688110000	ZTA 4	A.168
1688110000	ZTA 4	A.169
1688110000	ZTA 4	A.174
1688110000	ZTA 4	A.175
1688110000	ZTA 4	A.233
1689960000	ZDK 2.5N-DU	A.147
1689970000	ZDK 2.5DU-PE	A.147
1689980000	ZDK 2.5N-PE	A.147
1689990000	ZDK 2.5V	A.146

1690000000

1690000000	ZDK 2.5PE	A.174
1690010000	ZDK 2.5/LD RT/1	A.220
1690020000	ZDK 2.5/D/1	A.221
1690030000	ZDK 2.5/D/2	A.221
1690040000	ZDK 2.5/D/4	A.221
1690050000	ZDK 2.5/D/5	A.222
1690060000	ZDK 2.5/D/6	A.222
1692261001	KLBUE 3-8 SC	B.237
1692590000	ZDU 2.5/2X2AN/LD+	A.216
1692600000	ZDU 2.5/2X2AN/LD-	A.216
1693940000	ZDK 2.5/LD RT/2	A.220
1694140000	ZDK 2.5 OR	A.219
1697540000	ZDV 2.5/50	B.188
1697540000	ZDV 2.5/50	B.189
1698110000	ZPE 2.5/4AN WS	B.251
1698110000	ZPE 2.5/4AN WS	B.254
1698160000	ZRV 1.5	A.206
1698170000	ZRV 1.5/PE	A.206
1698180000	AP ZRV1.5 DB	A.206
1698190000	STGH 4 ZRV1.5	A.206
1698200000	STGH 4 ZRV1.5/PE GN	A.206

1700000000

1700530001	MARKO-C. 25X25X25 B/DR.	A.379
1700540001	MARKO-C. 50X50X50 B/DR.	A.379
1704350000	ZDUB 2.5-2/2AN/DM	A.123
1704360000	ZDUB 2.5-2/2AN/DM BL	A.123
1704370000	ZDUB 2.5-2/2AN/DM OR	A.123
1704380000	ZDUB 2.5-2/2AN/DM GE	A.123
1704500000	ZDUB 2.5-2/2AN/DB	A.123
1704530000	ZDUB 2.5-2/2AN/DB GE	A.123
1704540000	ZDUB 2.5-2/4AN/DM	A.123
1704550000	ZDUB 2.5-2/4AN/DM BL	A.123
1704560000	ZDUB 2.5-2/4AN/DM OR	A.123
1704570000	ZDUB 2.5-2/4AN/DM GE	A.123
1704690000	ZDUB 2.5-2/4AN/DB	A.123
1704700000	ZDUB 2.5-2/4AN/DB BL	A.123
1704720000	ZDUB 2.5-2/4AN/DB GE	A.123
1704740000	ZBB ZDUB	A.123
1704750000	ZAP ZDUB	A.122
1704750000	ZAP ZDUB	A.123
1704750000	ZAP ZDUB	A.124
1704750000	ZAP ZDUB	A.161
1704760000	ZAP ZDUB BL	A.122
1704760000	ZAP ZDUB BL	A.123
1704760000	ZAP ZDUB BL	A.124
1704770000	ZAP ZDUB OR	A.122
1704770000	ZAP ZDUB OR	A.123
1704770000	ZAP ZDUB OR	A.124
1705310000	DFFC 0.2-0.35 ZRV1.5	A.206
1705320000	DFFC 5-1.0 ZRV1.5	A.206
1706010000	ZDU 2.5-2/3AN	A.138
1706040000	ZDU 2.5-2/3AN BL	A.138
1706060000	ZDU 2.5-2/4AN	A.139
1706070000	ZDU 2.5-2/4AN BL	A.139
1706090000	ZPE 2.5-2/3AN	A.168
1706100000	ZPE 2.5-2/4AN	A.169
1706110000	ZAP/TW7	A.138
1706110000	ZAP/TW7	A.139
1706110000	ZAP/TW7	A.168
1706110000	ZAP/TW7	A.169
1706110000	ZAP/TW7	A.193
1706110000	ZAP/TW7	A.218
1706110000	ZAP/TW7	A.219
1706120000	ZAP/TW7 BL	A.138
1706120000	ZAP/TW7 BL	A.139

1710000000

1711930000	ZVL 1.5 0.0V	B.189
1712311001	KLBUE 4-13.5 SC	B.237
1712750000	ZDUB 2.5-2/2AN/15	A.124
1712760000	ZDUB 2.5-2/2AN/15 BL	A.124
1712770000	ZDUB 2.5-2/2AN/15 OR	A.124
1712780000	ZDUB 2.5-2/4AN/15	A.124
1712790000	ZDUB 2.5-2/4AN/15 BL	A.124
1712800000	ZDUB 2.5-2/4AN/15 OR	A.124
1712810000	ZPEB 2.5-2	A.161
1712820000	ZDUB 2.5-2/2AN/RC	A.122
1712830000	ZDUB 2.5-2/2AN/RC BL	A.122
1712970000	ZDUB 2.5-2/4AN/RC	A.122
1712980000	ZDUB 2.5-2/4AN/RC BL	A.122

Order No.	Type	Page
1713000000	ZDUB 2.5-2/4AN/RC GE	A.122
1715970000	WSH 3/H/N	B.242

Order No.	Type	Page
1754200000	WAP WDK 1.5/R3.5	A.262
1754210000	ZDV 1.5N/R3.5/2 GE	A.240
1754290000	ZDV 1.5N/R3.5/10 GE	A.240
1754960000	WTL 4	B.158
1754970000	WTL 4/STB	B.158
1755081001	KLBLUE CD 5	B.235
1755270000	DEK 5/3/5 MC NE WS	A.128
1755270000	DEK 5/3/5 MC NE WS	A.129
1755270000	DEK 5/3/5 MC NE WS	A.144
1755270000	DEK 5/3/5 MC NE WS	A.145
1755270000	DEK 5/3/5 MC NE WS	A.161
1755270000	DEK 5/3/5 MC NE WS	A.162
1755270000	DEK 5/3/5 MC NE WS	A.174
1755270000	DEK 5/3/5 MC NE WS	A.240
1755270000	DEK 5/3/5 MC NE WS	A.262
1755270000	DEK 5/3/5 MC NE WS	A.272

1760000000

1760720000	BS 35/W5H	B.243
1763940000	WTR 2.5/SI	A.299
1763950000	WTR 2.5/SI LD 36V	A.299
1764100000	ZAP/TW ZDU16 BL	A.135
1764110000	ZAP/TW ZDU10 BL	A.134
1764560000	ZAD 1/4-2 GE	A.138
1764560000	ZAD 1/4-2 GE	A.139
1764560000	ZAD 1/4-2 GE	A.152
1764560000	ZAD 1/4-2 GE	A.163
1764560000	ZAD 1/4-2 GE	A.154
1764560000	ZAD 1/4-2 GE	A.135

170000000

1766900000	WTW WTL 6/1 4MM	B.160
------------	-----------------	-------

1760000000

1767670000	ZPE 10/3AN	A.166
1767690000	ZDU 10/3AN	A.134
1767700000	ZDU 10/3AN BL	A.134
1768000000	ZMAK 2.5	A.151
1768000000	ZMAK 2.5	B.95
1768010000	ZAP ZMAK2.5	A.151
1768010000	ZAP ZMAK2.5	B.95
1768020000	BS 35II KLBLUE2X38/2X2-6	B.239
1768310000	ZPE 16/3AN	A.167
1768320000	ZDU 16/3AN	A.135
1768330000	ZDU 16/3AN BL	A.135
1768520000	ZAP/TW 10/16 BL	A.134
1768520000	ZAP/TW 10/16 BL	A.135
1768800000	ZDK 2.5 EM	A.219

1770000000

1770360000	ZDU 4-2/3AN	A.139
1770370000	ZDU 4-2/2AN	A.139
1770380000	ZPE 4-2/2AN	A.169
1770390000	ZPE 4-2/3AN	A.169
1770400000	ZAP ZDU4-2	A.139
1770400000	ZAP ZDU4-2	A.140
1770400000	ZAP ZDU4-2	A.169
1770840000	ZDU 4-2/2AN BL	A.139
1770860000	ZDU 4-2/3AN BL	A.139
1770880000	ZAP ZDU4-2 BL	A.139
1770890000	ZAP ZDU4-2 BL	A.140
1771300000	ZPE 6-2/3AN	A.171
1771370000	ZPE 6-2/2AN	A.170
1771380000	ZDU 6-2/2AN	A.141
1771390000	ZDU 6-2/2AN BL	A.141
1771410000	ZDU 6-2/3AN	A.141
1771420000	ZDU 6-2/3AN BL	A.141
1771440000	ZAP ZDU6-2	A.141
1771440000	ZAP ZDU6-2	A.170
1771440000	ZAP ZDU6-2	A.171
1771440000	ZAP ZDU6-2	A.193
1771440000	ZAP ZDU6-2	A.219
1771440000	ZAP ZDU6-2	B.268
1771800000	ZTL 6	B.156
1771800000	ZTL 6	B.157
1771810000	ZTD 6	B.156
1771810000	ZTD 6	B.157
1771820000	KSBR/2 ZTL6	B.156
1771820000	KSBR/2 ZTL6	B.157
1771830000	KSBR/3 ZTL6	B.157
1771840000	KSBR/4 ZTL6	B.157
1771860000	SSP ZTL6	B.156
1771860000	SSP ZTL6	B.157
1771870000	ZTW ZTL6	B.156
1771870000	ZTW ZTL6	B.157
1771950000	ZTL 6/STB	B.157
1771960000	ZTD 6/STB	B.157
1772060000	ZDU 2.5-2	A.138
1772070000	ZDU 2.5-2 BL	A.138
1772090000	ZPE 2.5-2	A.168
1772940000	ZEI 16-2/1AN	A.141
1772950000	ZEI 16-2/1AN BL	A.141
1772960000	ZPE 16-2/1AN	A.171
1772970000	ZAP/Z...16-2/1AN	A.141
1772970000	ZAP/Z...16-2/1AN	A.171

Order No.	Type	Page
1774670000	WTR 2.5/ZZ 0.TNHE	A.309
1775480000	ZDU 1.5	A.128
1775490000	ZDU 1.5 BL	A.128
1775510000	ZPE 1.5	A.161
1775530000	ZDU 1.5/3AN	A.128
1775540000	ZDU 1.5/3AN BL	A.128
1775560000	ZPE 1.5/3AN	A.161
1775580000	ZDU 1.5/4AN	A.129
1775600000	ZDU 1.5/4AN BL	A.129
1775620000	ZPE 1.5/4AN	A.162
1776030000	ZAP/TW ZDU1.5/2AN	A.128
1776030000	ZAP/TW ZDU1.5/2AN	A.161
1776040000	ZAP/TW ZDU1.5/2AN BL	A.128
1776060000	ZAP/TW ZDU1.5/3AN	A.128
1776060000	ZAP/TW ZDU1.5/3AN	A.161
1776070000	ZAP/TW ZDU1.5/3AN BL	A.128
1776090000	ZAP/TW ZDU1.5/4AN	A.129
1776090000	ZAP/TW ZDU1.5/4AN	A.162
1776100000	ZAP/TW ZDU1.5/4AN BL	A.129
1776120000	ZDV 1.5/2	A.128
1776120000	ZDV 1.5/2	A.129
1776120000	ZDV 1.5/2	A.144
1776120000	ZDV 1.5/2	A.145
1776120000	ZDV 1.5/2	A.230
1776130000	ZDV 1.5/3	A.230
1776140000	ZDV 1.5/4	A.230
1776150000	ZDV 1.5/5	A.230
1776200000	ZDV 1.5/10	A.128
1776200000	ZDV 1.5/10	A.129
1776200000	ZDV 1.5/10	A.144
1776200000	ZDV 1.5/10	A.145
1776200000	ZDV 1.5/10	A.230
1776270000	WS 12/3/5 MC NE WS	A.128
1776270000	WS 12/3/5 MC NE WS	A.129
1776270000	WS 12/3/5 MC NE WS	A.161
1776270000	WS 12/3/5 MC NE WS	A.162
1779000000	ZDU 2.5-2/D-	A.219
1779010000	ZTR 2.5-2	A.193
1779100000	TSTW 5/M5 ZN	C.22
1779110000	ZDU 2.5-2/D+	A.218
1779120000	ZTR 2.5-2 BL	A.193

1780000000

1780660000	ZTA 6/ZA	A.139
1780660000	ZTA 6/ZA	A.140
1780660000	ZTA 6/ZA	A.155
1780660000	ZTA 6/ZA	A.156
1780660000	ZTA 6/ZA	A.157
1780660000	ZTA 6/ZA	A.169
1780660000	ZTA 6/ZA	A.170
1780660000	ZTA 6/ZA	A.175
1780660000	ZTA 6/ZA	A.232
1780670000	ZTA 7/ZA	A.141
1780670000	ZTA 7/ZA	A.170
1780670000	ZTA 7/ZA	A.171
1780670000	ZTA 7/ZA	A.232
1780670000	ZTA 7/ZA	B.268
1780850000	WF 6	A.367
1780860000	WF 8	A.368
1780870000	WF 10	A.367
1780880000	WF 12	A.369
1780890000	WTW WF10/WF12	A.368
1780890000	WTW WF10/WF12	A.369
1780890000	WTW WF10/WF12	A.370
1780890000	WTW WF10/WF12	A.371
1780890000	WTW WF10/WF12	A.378
1780900000	WTW WF8	A.367
1780900000	WTW WF8	A.368
1780900000	WTW WF8	A.378
1780910000	WTW WF8 2300	A.367
1780910000	WTW WF8 2300	A.368
1780910000	WTW WF8 2300	A.370
1780910000	WTW WF8 2300	A.379
1780920000	WTW WF10/WF12 2300	A.368
1780920000	WTW WF10/WF12 2300	A.369
1780920000	WTW WF10/WF12 2300	A.371
1780920000	WTW WF10/WF12 2300	A.379
1780930000	ADP WF6/WF8	A.366
1780930000	ADP WF6/WF8	A.367
1780930000	ADP WF6/WF8	A.368
1780940000	ADP WF10/WF12	A.368
1780940000	ADP WF10/WF12	A.369
1780940000	ADP WF10/WF12	A.370
1780940000	ADP WF10/WF12	A.371
1780970000	WQL 2 WF6	A.367
1780970000	WQL 2 WF6	A.370
1780970000	WQL 2 WF6	A.378
1780980000	WQL 3 WF6	A.367
1780980000	WQL 3 WF6	A.370
1780980000	WQL 3 WF6	A.378
1780990000	WQL 2 WF8	A.367
1780990000	WQL 2 WF8	A.368
1780990000	WQL 2 WF8	A.370
1780990000	WQL 2 WF8	A.378
1781000000	WQL 3 WF8	A.367
1781000000	WQL 3 WF8	A.368
1781000000	WQL 3 WF8	A.370
1781000000	WQL 3 WF8	A.378

Order No.	Type	Page
1781010000	WQL 2 WF10	A.368
1781010000	WQL 2 WF10	A.369
1781010000	WQL 2 WF10	A.371
1781010000	WQL 2 WF10	A.378
1781020000	WQL 3 WF10	A.368
1781020000	WQL 3 WF10	A.369
1781020000	WQL 3 WF10	A.371
1781020000	WQL 3 WF10	A.378
1781030000	WQL 2 WF12	A.369
1781030000	WQL 2 WF12	A.378
1781040000	WQL 3 WF12	A.369
1781040000	WQL 3 WF12	A.378
1781050000	HA ADP WF6/WF10	A.366
1781050000	HA ADP WF6/WF10	A.367
1781050000	HA ADP WF6/WF10	A.368
1781050000	HA ADP WF6/WF10	A.369
1781050000	HA ADP WF6/WF10	A.370
1781050000	HA ADP WF6/WF10	A.371
1781400000	BZT ZTL6	B.156
1781400000	BZT ZTL6	B.157
1781220000	WTW WF6	A.366
1781220000	WTW WF6	A.367
1781220000	WTW WF6	A.378
1781230000	WTW WF6 2300	A.366
1781230000	WTW WF6 2300	A.367
1781230000	WTW WF6 2300	A.370
1781230000	WTW WF6 2300	A.379
1781240000	WTW WF6-WF12	A.366
1781240000	WTW WF6-WF12	A.367
1781240000	WTW WF6-WF12	A.378
1781940000	ZAD 7/4	A.128
1781940000	ZAD 7/4	A.129
1781940000	ZAD 7/4	A.144
1781940000	ZAD 7/4	A.145
1781950000	ZRH 1.5S/1	A.128
1781950000	ZRH 1.5S/1	A.129
1781950000	ZRH 1.5S/1	A.144
1781950000	ZRH 1.5S/1	A.145
1781950000	ZRH 1.5S/1	A.161
1781950000	ZRH 1.5S/1	A.162
1781950000	ZRH 1.5S/1	A.174
1781950000	ZRH 1.5S/1	A.235
1782300000	ZDL2 2.5-2N	A.148
1782310000	ZDL2 2.5-2N BL	A.148
1782320000	ZDL2 2.5-2VN	A.148
1782330000	ZDL2 2.5-2VN BL	A.148
1782340000	ZAP/TW ZDL2.5-2N	A.148
1782340000	ZAP/TW ZDL2.5-2N	A.149
1782350000	ZAP/TW ZDL2.5-2N BL	A.148
1782350000	ZAP/TW ZDL2.5-2N BL	A.149
1783550000	AP DL2.5 DB	B.190
1783550000	AP DL2.5 DB	B.191
1783550000	AP DL2.5 DB	B.192
1783550000	AP DL2.5 DB	B.193
1783550000	DLA 2.5 DB	B.192
1783590000	DLA 2.5/D DB	B.192
1783600000	DLA 2.5/LD-RT DB	B.193
1783790000	DL2 2.5/PE DB	B.190
1783800000	AP DL2.5/PE DB	B.190
1783820000	DLI 2.5 DB	B.191
1783940000	DLI 2.5/LD-GN/NPN → DB	B.191
1783950000	DLI 2.5/LD-RT/NPN → DB	B.191
1783970000	DLI 2.5/LD-GN/PNP → DB	B.191
1783980000	DLI 2.5/LD-RT/PNP → DB	B.191
1784120000	VLI 1.5 DB	A.271
1784120000	VLI 1.5 DB	B.97
1784130000	VLI 1.5/PE DB	A.271
1784130000	VLI 1.5/PE DB	B.97
1784150000	AP VLI1.5 DB	A.271
1784150000	AP VLI1.5 DB	B.97
1784180000	DL2 2.5 DB	B.190
1784460000	WDU 1.5/2DV/BLZ 5.08	A.328
1789770000	WF 6/2BZ	A.370
1789780000	WF 8/2BZ	A.370
1789790000	WF 10/2BZ	A.371

1790000000

1790130000	WF 5	A.366
1790520000	ZDU 4-2/3ANLSC	A.140
1790990000	ZDK 2.5-2	A.152
1791000000	ZDK 2.5-2 BL	A.152
1791010000	ZDK 2.5-2PE	A.175
1791030000	ZDK 2.5-2V	A.152
1791040000	ZDK 2.5-2V BL	A.152
1791050000	ZAP/TW ZDK2.5-2	A.152
1791050000	ZAP/TW ZDK2.5-2	A.175
1791060000	ZAP/TW ZDK2.5-2 BL	A.152
1791100000	ZDK 1.5	A.144
1791100000	ZDK 1.5 BL	A.144
1791120000	ZDK 1.5DUPE	A.145
1791130000	ZDK 1.5V	A.144
1791140000	ZDK 1.5V BL	A.144
1791150000	ZDK 1.5PE	A.174
1791160000	ZAP/TW ZDK1.5	A.144
1791160000	ZAP/TW ZDK	

Order No.	Type	Page
1815140000	ZTPE 2.5/4AN/4	A.200
1815150000	ZDT 2.5/2	A.202
1815160000	ZDT 2.5/2 DUPE	A.203
1815170000	ZDT 2.5/2 PE	A.204
1815180000	ZP 2.5/1AN/17	A.208
1815190000	ZP 2.5/1AN/QV/1	A.196
1815190000	ZP 2.5/1AN/QV/1	A.197
1815190000	ZP 2.5/1AN/QV/1	A.202
1815190000	ZP 2.5/1AN/QV/1	A.203
1815190000	ZP 2.5/1AN/QV/1	A.209
1815200000	ZP 2.5/1AN/QV/2	A.196
1815200000	ZP 2.5/1AN/QV/2	A.197
1815200000	ZP 2.5/1AN/QV/2	A.202
1815200000	ZP 2.5/1AN/QV/2	A.203
1815200000	ZP 2.5/1AN/QV/2	A.209
1815210000	ZP 2.5/1AN/QV/3	A.196
1815210000	ZP 2.5/1AN/QV/3	A.197
1815210000	ZP 2.5/1AN/QV/3	A.202
1815210000	ZP 2.5/1AN/QV/3	A.203
1815210000	ZP 2.5/1AN/QV/3	A.209
1815220000	ZP 2.5/1AN/QV/4	A.196
1815220000	ZP 2.5/1AN/QV/4	A.197
1815220000	ZP 2.5/1AN/QV/4	A.202
1815220000	ZP 2.5/1AN/QV/4	A.203
1815220000	ZP 2.5/1AN/QV/4	A.209
1815230000	ZP 2.5/1AN/QV/5	A.196
1815230000	ZP 2.5/1AN/QV/5	A.197
1815230000	ZP 2.5/1AN/QV/5	A.202
1815230000	ZP 2.5/1AN/QV/5	A.203
1815230000	ZP 2.5/1AN/QV/5	A.209
1815240000	ZP 2.5/1AN/QV/6	A.196
1815240000	ZP 2.5/1AN/QV/6	A.197
1815240000	ZP 2.5/1AN/QV/6	A.202
1815240000	ZP 2.5/1AN/QV/6	A.203
1815240000	ZP 2.5/1AN/QV/6	A.209
1815250000	ZP 2.5/1AN/QV/7	A.196
1815250000	ZP 2.5/1AN/QV/7	A.197
1815250000	ZP 2.5/1AN/QV/7	A.202
1815250000	ZP 2.5/1AN/QV/7	A.203
1815250000	ZP 2.5/1AN/QV/7	A.209
1815260000	ZP 2.5/1AN/QV/8	A.196
1815260000	ZP 2.5/1AN/QV/8	A.197
1815260000	ZP 2.5/1AN/QV/8	A.202
1815260000	ZP 2.5/1AN/QV/8	A.203
1815260000	ZP 2.5/1AN/QV/8	A.209
1815270000	ZP 2.5/1AN/QV/9	A.196
1815270000	ZP 2.5/1AN/QV/9	A.197
1815270000	ZP 2.5/1AN/QV/9	A.202
1815270000	ZP 2.5/1AN/QV/9	A.203
1815270000	ZP 2.5/1AN/QV/9	A.209
1815280000	ZP 2.5/1AN/QV/10	A.196
1815280000	ZP 2.5/1AN/QV/10	A.197
1815280000	ZP 2.5/1AN/QV/10	A.202
1815280000	ZP 2.5/1AN/QV/10	A.203
1815280000	ZP 2.5/1AN/QV/10	A.209
1815290000	ZP 2.5/1AN/QV/11	A.209
1815300000	ZP 2.5/1AN/QV/12	A.209
1815310000	ZP 2.5/1AN/QV/13	A.209
1815320000	ZP 2.5/1AN/QV/14	A.209
1815330000	ZP 2.5/1AN/QV/15	A.209
1815340000	ZP 2.5/1AN/QV/16	A.209
1815350000	ZP 2.5/1AN/QV/17	A.209
1815430000	ZP 2.5/1AN/1	A.197
1815430000	ZP 2.5/1AN/1	A.208
1815440000	ZP 2.5/1AN/2	A.197
1815440000	ZP 2.5/1AN/2	A.208
1815450000	ZP 2.5/1AN/3	A.197
1815450000	ZP 2.5/1AN/3	A.208
1815500000	ZP 2.5/1AN/4	A.197
1815500000	ZP 2.5/1AN/4	A.208
1815510000	ZP 2.5/1AN/5	A.208
1815510000	ZP 2.5/1AN/5	A.208
1815520000	ZP 2.5/1AN/6	A.197
1815520000	ZP 2.5/1AN/6	A.208
1815530000	ZP 2.5/1AN/7	A.197
1815530000	ZP 2.5/1AN/7	A.208
1815540000	ZP 2.5/1AN/8	A.197
1815540000	ZP 2.5/1AN/8	A.208
1815550000	ZP 2.5/1AN/9	A.197
1815550000	ZP 2.5/1AN/9	A.208
1815560000	ZP 2.5/1AN/10	A.197
1815560000	ZP 2.5/1AN/10	A.208
1815570000	ZP 2.5/1AN/11	A.208
1815580000	ZP 2.5/1AN/12	A.208
1815590000	ZP 2.5/1AN/13	A.208
1815600000	ZP 2.5/1AN/14	A.208
1815610000	ZP 2.5/1AN/15	A.208
1815620000	ZP 2.5/1AN/16	A.208
1815730000	ZP 2.5/2AN/QV/1	A.209
1815740000	ZP 2.5/2AN/QV/2	A.209
1815750000	ZP 2.5/2AN/QV/3	A.209
1815760000	ZP 2.5/2AN/QV/4	A.209
1815770000	ZP 2.5/2AN/QV/5	A.209
1815780000	ZP 2.5/2AN/QV/6	A.209
1815790000	ZP 2.5/2AN/QV/7	A.209
1815800000	ZP 2.5/2AN/QV/8	A.209
1815810000	ZP 2.5/2AN/QV/9	A.209
1815820000	ZP 2.5/2AN/QV/10	A.209
1815830000	ZP 2.5/2AN/QV/11	A.209

Order No.	Type	Page
1815840000	ZP 2.5/2AN/QV/12	A.209
1815870000	ZP 2.5/2AN/QV/15	A.209
1815880000	ZP 2.5/2AN/QV/16	A.209
1816030000	ZAP/TW ZT2.5/2AN	A.196
1816030000	ZAP/TW ZT2.5/2AN	A.199
1816040000	ZAP/TW ZT2.5/2AN OR	A.196
1816040000	ZAP/TW ZT2.5/2AN OR	A.199
1816050000	ZAP/TW ZT2.5/3AN	A.196
1816050000	ZAP/TW ZT2.5/3AN	A.199
1816070000	ZAP/TW ZT2.5/4AN/2	A.197
1816070000	ZAP/TW ZT2.5/4AN/2	A.200
1816080000	ZAP/TW ZT2.5/4AN/2 OR	A.197
1816080000	ZAP/TW ZT2.5/4AN/2 OR	A.200
1816090000	ZAP/TW ZT2.5/4AN/4	A.197
1816090000	ZAP/TW ZT2.5/4AN/4	A.200
1816100000	ZAP/TW ZDT2.5/2	A.202
1816100000	ZAP/TW ZDT2.5/2	A.203
1816110000	ZAP/TW ZDT2.5/2	A.204
1816130000	ZVR ZP2.5	A.196
1816130000	ZVR ZP2.5	A.197
1816130000	ZVR ZP2.5	A.199
1816130000	ZVR ZP2.5	A.200
1816130000	ZVR ZP2.5	A.202
1816130000	ZVR ZP2.5	A.203
1816130000	ZVR ZP2.5	A.204
1816130000	ZVR ZP2.5	A.213
1816140000	ZZE ZP2.5	A.196
1816140000	ZZE ZP2.5	A.197
1816140000	ZZE ZP2.5	A.199
1816140000	ZZE ZP2.5	A.200
1816140000	ZZE ZP2.5	A.202
1816140000	ZZE ZP2.5	A.203
1816140000	ZZE ZP2.5	A.204
1816150000	KOSF ZT2.5	A.196
1816150000	KOSF ZT2.5	A.197
1816150000	KOSF ZT2.5	A.199
1816150000	KOSF ZT2.5	A.200
1816150000	KOSF ZT2.5	A.202
1816150000	KOSF ZT2.5	A.203
1816150000	KOSF ZT2.5	A.204
1816150000	KOSF ZT2.5	A.213
1818400000	WS 10/6 M MC NE WS	A.85

182000000

1820550000	WDU 95N/120N	A.257
1820550000	WDU 95N/120N	B.29
1820560000	WDU 95N/120N BL	A.257
1820560000	WDU 95N/120N BL	B.29
1820570000	ZP 2.5/1AN/QV/1 GN	A.209
1820580000	ZP 2.5/1AN/1 GN	A.208
1820590000	ZP 2.5/2AN/QV/1 GN	A.209
1820840000	WDU 50N	A.256
1820840000	WDU 50N	B.27
1820850000	WDU 50N BL	A.256
1820850000	WDU 50N BL	B.27
1820930000	ZSI 6-2 2X2.5/G20	A.186
1820950000	ZSI 6-2 2X2.5/G25	A.187
1822210000	WDU 240 BL	A.258
1822210000	WDU 240 BL	B.30
1826050000	ZSI 2.5-2/2X2AN/G20	A.182
1826200000	ZSI 2.5-2/2X2AN/G25	A.182
1826890000	WQV 95N/120M/2	A.257
1826890000	WQV 95N/120M/2	A.349
1826890000	WQV 95N/120M/2	A.349
1826890000	WQV 95N/120M/2	B.29
1826890000	WQV 95N/120M/2	B.266
1826900000	WQV 95N/120M/3	A.257
1826900000	WQV 95N/120M/3	A.349
1826900000	WQV 95N/120M/3	B.29
1826900000	WQV 95N/120M/3	B.266
1826910000	WQV 95N/120M/4	A.257
1826910000	WQV 95N/120M/4	A.349
1826910000	WQV 95N/120M/4	B.29
1826910000	WQV 95N/120M/4	B.266
1827080000	ZTA ZT2.5	A.142
1827080000	ZTA ZT2.5	A.143
1827080000	ZTA ZT2.5	A.143
1827080000	ZTA ZT2.5	A.158
1827080000	ZTA ZT2.5	A.159
1827080000	ZTA ZT2.5	A.172
1827080000	ZTA ZT2.5	A.173
1827080000	ZTA ZT2.5	A.176
1827080000	ZTA ZT2.5	A.196
1827080000	ZTA ZT2.5	A.197
1827080000	ZTA ZT2.5	A.199
1827080000	ZTA ZT2.5	A.200
1827080000	ZTA ZT2.5	A.201
1827080000	ZTA ZT2.5	A.202
1827080000	ZTA ZT2.5	A.203
1827080000	ZTA ZT2.5	A.204
1827080000	ZTA ZT2.5	A.208
1827080000	ZTA ZT2.5	A.209
1827080000	ZTA ZT2.5	A.232
1828450000	WS 10/6 MC NE WS	A.132
1828450000	WS 10/6 MC NE WS	A.198
1828450000	WS 10/6 MC NE WS	A.201
1828450000	WS 10/6 MC NE WS	A.210
1828450000	WS 10/6 MC NE WS	A.367

Order No.	Type	Page
1828450000	WS 10/6 MC NE WS	A.368
1828450000	WS 10/6 MC NE WS	A.369

183000000

1831280000	ZTR 2.5	A.192
1833090000	TNST	A.70
1833090000	TNST	A.71
1833090000	TNST	A.192
1833090000	TNST	A.193
1833090000	TNST	A.205
1833090000	TNST	A.237
1833090000	TNST	A.311
1833090000	TNST	A.316
1833090000	TNST	A.318
1833090000	TNST	A.319
1833090000	TNST	B.221
1833090000	TNST	B.222
1833090000	TNST	B.223
1833090000	TNST	B.224
1833090000	TNST	B.225
1833090000	BEST	A.70
1833100000	BEST	A.71
1833100000	BEST	A.192
1833100000	BEST	A.193
1833100000	BEST	A.205
1833100000	BEST	A.237
1833100000	BEST	A.308
1833100000	BEST	A.309
1833100000	BEST	A.310
1833100000	BEST	A.311
1833100000	BEST	A.316
1833100000	BEST	A.318
1833100000	BEST	A.319
1833100000	BEST	B.205
1833100000	BEST	B.206
1833100000	BEST	B.207
1833100000	BEST	B.211
1833100000	BEST	B.212
1833100000	BEST	B.221
1833100000	BEST	B.222
1833100000	BEST	B.223
1833100000	BEST	B.224
1833100000	BEST	B.225
1833100000	BEST	B.290
1833100000	BEST	B.291
1833100000	BEST	B.292
1833100000	BEST	B.293
1833600000	WDK 2.5/TR-DU/0 TNHE	A.318
1833640000	WDK 2.5/TR-DU-PE/0 TNHE	A.319
1834060000	WQV 50N/2	A.256
1834060000	WQV 50N/2	A.348
1834060000	WQV 50N/2	B.27
1834060000	WQV 50N/2	B.28
1834060000	WQV 50N/2	B.265
1834080000	WQV 50N/4	A.256
1834080000	WQV 50N/4	A.348
1834080000	WQV 50N/4	B.27
1834080000	WQV 50N/4	B.28
1834080000	WQV 50N/4	B.265
1837380000	TS 35X15/5X18 2M/ST/ZN	C.19
1839850000	WAP WDK 2.5N/TR-DU	A.318
1839850000	WAP WDK 2.5N/TR-DU	A.319

184000000

1846030000	WPE 95N/120N	A.280
1846030000	WPE 95N/120N	B.34
1846040000	WPE 50N	A.279
1846040000	WPE 50N	B.33
1847600000	ZTA ZT2.5/ZA	A.142
1847600000	ZTA ZT2.5/ZA	A.143
1847600000	ZTA ZT2.5/ZA	A.153
1847600000	ZTA ZT2.5/ZA	A.158
1847600000	ZTA ZT2.5/ZA	A.159
1847600000	ZTA ZT2.5/ZA	A.172
1847600000	ZTA ZT2.5/ZA	A.173
1847600000	ZTA ZT2.5/ZA	A.176
1847600000	ZTA ZT2.5/ZA	A.196
1847600000	ZTA ZT2.5/ZA	A.197
1847600000	ZTA ZT2.5/ZA	A.199
1847600000	ZTA ZT2.5/ZA	A.200
1847600000	ZTA ZT2.5/ZA	A.202
1847600000	ZTA ZT2.5/ZA	A.203
1847600000	ZTA ZT2.5/ZA	A.204
1847600000	ZTA ZT2.5/ZA	A.232
1847740000	STB 36.8/HH/DB WTL6/1	B.171
1847760000	STB 36.8/HH/GE WTL6/1	B.166
1847760000	STB 36.8/HH/GE WTL6/1	B.167
184776		

Order No.	Type	Page
1936250000	STB 21.6/45 GN	B.174
1936260000	STB 21.6/45 VI	B.166
1936260000	STB 21.6/45 VI	B.171
1936260000	STB 21.6/45 VI	B.172
1936260000	STB 21.6/45 VI	B.174
1936270000	STB 21.6/45 SW	B.166
1936270000	STB 21.6/45 SW	B.171
1936270000	STB 21.6/45 SW	B.172
1936270000	STB 21.6/45 SW	B.174
1936280000	STB 21.6/45 GR	B.171
1936290000	STB 21.6/45 BL	B.167
1936290000	STB 21.6/45 BL	B.168
1936290000	STB 21.6/45 BL	B.169
1936290000	STB 21.6/45 BL	B.171
1936300000	STB 21.6/45 RT	B.171
1938790000	STB 21.6/45 DB	B.171
1938820000	WTL 6/1/STB/TN3C/EN	B.169

1940000000

1943600000	BLZP 5.08HC/04/180 SN DR BX	A.328
1943600000	BLZP 5.08HC/04/180 SN DR BX	A.329
1943620000	BLZP 5.08HC/06/180 SN DR BX	A.328
1943620000	BLZP 5.08HC/06/180 SN DR BX	A.329
1943640000	BLZP 5.08HC/08/180 SN DR BX	A.328
1943640000	BLZP 5.08HC/08/180 SN DR BX	A.329
1944110000	BLZP 5.08HC/04/180F SN DR BX	A.328
1944110000	BLZP 5.08HC/04/180F SN DR BX	A.329
1944130000	BLZP 5.08HC/06/180F SN DR BX	A.328
1944130000	BLZP 5.08HC/06/180F SN DR BX	A.329
1944150000	BLZP 5.08HC/08/180F SN DR BX	A.328
1944150000	BLZP 5.08HC/08/180F SN DR BX	A.329
1948000000	BLZP 5.08HC/02/90 SN DR BX	B.226
1948010000	BLZP 5.08HC/03/90 SN DR BX	B.226
1948020000	BLZP 5.08HC/04/90 SN DR BX	B.226
1948030000	BLZP 5.08HC/05/90 SN DR BX	B.226
1948040000	BLZP 5.08HC/06/90 SN DR BX	B.226
1948050000	BLZP 5.08HC/07/90 SN DR BX	B.226
1948060000	BLZP 5.08HC/08/90 SN DR BX	B.226
1948070000	BLZP 5.08HC/09/90 SN DR BX	B.226
1948080000	BLZP 5.08HC/10/90 SN DR BX	B.226
1948100000	BLZP 5.08HC/11/90 SN DR BX	B.226
1948110000	BLZP 5.08HC/12/90 SN DR BX	B.226
1949800000	BLZP 5.08HC/02/90F SN DR BX	B.227
1949810000	BLZP 5.08HC/03/90F SN DR BX	B.227
1949820000	BLZP 5.08HC/04/90F SN DR BX	B.227
1949830000	BLZP 5.08HC/05/90F SN DR BX	B.227
1949840000	BLZP 5.08HC/06/90F SN DR BX	B.227
1949850000	BLZP 5.08HC/07/90F SN DR BX	B.227
1949860000	BLZP 5.08HC/08/90F SN DR BX	B.227
1949870000	BLZP 5.08HC/09/90F SN DR BX	B.227
1949880000	BLZP 5.08HC/10/90F SN DR BX	B.227
1949890000	BLZP 5.08HC/11/90F SN DR BX	B.227
1949900000	BLZP 5.08HC/12/90F SN DR BX	B.227

1950000000

1951880000	WS 8/6 PLUS MC NE WS	A.266
1951880000	WS 8/6 PLUS MC NE WS	A.267
1951880000	WS 8/6 PLUS MC NE WS	B.279
1951880000	WS 8/6 PLUS MC NE WS	B.283
1951880000	WS 8/6 PLUS MC NE WS	B.288
1951880000	WS 8/6 PLUS MC NE WS	B.289
1957710000	WAP WTL6/1 EN	B.166
1957710000	WAP WTL6/1 EN	B.167
1957710000	WAP WTL6/1 EN	B.168
1957710000	WAP WTL6/1 EN	B.169

1960000000

1964820000	BFEL + BEMU WEV WTL 35	B.178
1964820000	BFEL + BEMU WEV WTL 35	B.179
1964830000	WZAD 70N	A.257
1964830000	WZAD 70N	B.28
1964830000	WZAD 70N	B.29
1964830000	WZAD 70N	B.266
1966020000	WSI 25/1 10X38	A.295
1966030000	WSI 25/3 CC	A.295
1966040000	WSI 25/2 CC	A.295
1966050000	WSI 25/1 CC	A.295
1966060000	WSI 25/1 10X38/LED 69DV	A.295
1966070000	WSI 25/1 CC/LED	A.295
1966080000	WSI 25/3 10X38	A.295
1966090000	WSI 25/2 10X38	A.295
1968940000	WF 12 NFF	A.369
1968950000	WF 10 NFF	A.369
1968960000	WF 8 NFF	A.368
1968990000	WF 5 NFF	A.366
1969000000	WF 6 NFF	A.367

1970000000

1972980000	ZP 2.5/1AN ZA O.RA BL	A.212
------------	-----------------------	-------

1980000000

1985410000	ZQV 1.5N/2	A.16
1985410000	ZQV 1.5N/2	A.17
1985410000	ZQV 1.5N/2	A.24

Order No.	Type	Page
1985410000	ZQV 1.5N/2	A.27
1985410000	ZQV 1.5N/2	A.32
1985410000	ZQV 1.5N/2	A.33
1985410000	ZQV 1.5N/2	A.40
1985410000	ZQV 1.5N/2	A.41
1985410000	ZQV 1.5N/2	A.72
1985410000	ZQV 1.5N/2	A.73
1985410000	ZQV 1.5N/2	A.74
1985410000	ZQV 1.5N/2	A.75
1985410000	ZQV 1.5N/2	A.110
1985410000	ZQV 1.5N/2	A.262
1985410000	ZQV 1.5N/2	B.52
1985410000	ZQV 1.5N/2	B.297
1985480000	ZQV 1.5N/3	A.110
1985490000	ZQV 1.5N/4	A.110
1985500000	ZQV 1.5N/5	A.110
1985510000	ZQV 1.5N/6	A.110
1985520000	ZQV 1.5N/7	A.110
1985530000	ZQV 1.5N/2 BL	A.110
1985530000	ZQV 1.5N/2 BL	B.102
1985530000	ZQV 1.5N/2 BL	B.103
1985530000	ZQV 1.5N/2 BL	B.104
1985530000	ZQV 1.5N/2 BL	B.105
1985530000	ZQV 1.5N/2 BL	B.184
1985530000	ZQV 1.5N/2 BL	B.185
1985540000	ZQV 1.5N/8	A.110
1985550000	ZQV 1.5N/3 BL	A.110
1985560000	ZQV 1.5N/9	A.110
1985570000	ZQV 1.5N/4 BL	A.110
1985580000	ZQV 1.5N/10	A.16
1985580000	ZQV 1.5N/10	A.17
1985580000	ZQV 1.5N/10	A.24
1985580000	ZQV 1.5N/10	A.27
1985580000	ZQV 1.5N/10	A.32
1985580000	ZQV 1.5N/10	A.33
1985580000	ZQV 1.5N/10	A.40
1985580000	ZQV 1.5N/10	A.41
1985580000	ZQV 1.5N/10	A.72
1985580000	ZQV 1.5N/10	A.73
1985580000	ZQV 1.5N/10	A.74
1985580000	ZQV 1.5N/10	A.75
1985580000	ZQV 1.5N/10	A.110
1985580000	ZQV 1.5N/10	A.110
1985580000	ZQV 1.5N/10	A.262
1985580000	ZQV 1.5N/10	B.52
1985580000	ZQV 1.5N/10	B.297
1985590000	ZQV 1.5N/5 BL	A.110
1985600000	ZQV 1.5N/20	A.110
1985610000	ZQV 1.5N/6 BL	A.110
1985620000	ZQV 1.5N/50 BL	A.110
1985630000	ZQV 1.5N/7 BL	A.110
1985640000	ZQV 1.5N/8 BL	A.110
1985650000	ZQV 1.5N/2 RD	A.110
1985650000	ZQV 1.5N/2 RD	B.102
1985650000	ZQV 1.5N/2 RD	B.103
1985650000	ZQV 1.5N/2 RD	B.104
1985650000	ZQV 1.5N/2 RD	B.105
1985650000	ZQV 1.5N/2 RD	B.106
1985650000	ZQV 1.5N/2 RD	B.107
1985650000	ZQV 1.5N/2 RD	B.184
1985650000	ZQV 1.5N/2 RD	B.185
1985660000	ZQV 1.5N/9 BL	A.110
1985670000	ZQV 1.5N/3 RD	A.110
1985680000	ZQV 1.5N/10 BL	A.110
1985680000	ZQV 1.5N/10 BL	B.102
1985680000	ZQV 1.5N/10 BL	B.103
1985680000	ZQV 1.5N/10 BL	B.104
1985680000	ZQV 1.5N/10 BL	B.105
1985680000	ZQV 1.5N/10 BL	B.184
1985680000	ZQV 1.5N/10 BL	B.185
1985690000	ZQV 1.5N/4 RD	A.110
1985700000	ZQV 1.5N/20 BL	A.110
1985710000	ZQV 1.5N/5 BL	A.110
1985720000	ZQV 1.5N/50 BL	A.110
1985730000	ZQV 1.5N/6 RD	A.110
1985740000	ZQV 6N/2	A.22
1985740000	ZQV 6N/2	A.23
1985740000	ZQV 6N/2	A.111
1985740000	ZQV 6N/2	B.52
1985740000	ZQV 6N/2	B.258
1985750000	ZQV 1.5N/7 RD	A.110
1985760000	ZQV 6N/3	A.22
1985760000	ZQV 6N/3	A.23
1985760000	ZQV 6N/3	A.23
1985760000	ZQV 6N/3	A.111
1985760000	ZQV 6N/3	B.258
1985770000	ZQV 1.5N/8 RD	A.110
1985780000	ZQV 6N/4	A.22
1985780000	ZQV 6N/4	A.23
1985780000	ZQV 6N/4	A.111
1985780000	ZQV 6N/4	B.52
1985780000	ZQV 6N/4	B.145
1985780000	ZQV 6N/4	B.258
1985790000	ZQV 1.5N/9 RD	A.110
1985800000	ZQV 1.5N/10 RD	A.110
1985800000	ZQV 1.5N/10 RD	B.102
1985800000	ZQV 1.5N/10 RD	B.103
1985800000	ZQV 1.5N/10 RD	B.104
1985800000	ZQV 1.5N/10 RD	B.105

Order No.	Type	Page
1985800000	ZQV 1.5N/10 RD	B.106
1985800000	ZQV 1.5N/10 RD	B.107
1985800000	ZQV 1.5N/10 RD	B.184
1985800000	ZQV 1.5N/10 RD	B.185
1985810000	ZQV 1.5N/20 RD	A.110
1985820000	ZQV 1.5N/50 RD	A.110
1985830000	ZQV 6N/2 BL	A.111
1985830000	ZQV 6N/2 BL	B.282
1985840000	ZQV 6N/3 BL	A.111
1985850000	ZQV 6N/4 BL	A.111
1988100000	AAP12 2.5 LI BL	B.109
1988130000	AAP11 6 LI BL	B.102
1988140000	AAP11 6 FE	B.102
1988160000	AAP11 1.5 LI RD	B.103
1988170000	AAP11 1.5 LI BL	B.103
1988180000	AAP12 10 LO LB	B.108
1988190000	AAP12 10 LO RD	B.108
1988200000	AAP12 10 FE	B.108
1988230000	AAP14 2.5 LHI	B.111
1988240000	AAP14 2.5 LO	B.110
1988250000	AAP14 10 LO	B.110
1988260000	AAP13 6 LO LB	B.104
1988270000	AAP13 6 FE LO	B.104
1988280000	AAP13 1.5 LHI	B.105
1988290000	AAP12 2.5 LI RD	B.109
1988300000	AEP AP12	B.108
1988300000	AEP AP12	B.109
1988320000	AEP AP11	B.102
1988320000	AEP AP11	B.103
1988340000	AEP AP14	B.110
1988340000	AEP AP14	B.111
1989780000	AAP11 6 LO RD	B.102
1989800000	ADT 2.5 2C	A.60
1989800000	ADT 2.5 2C	A.66
1989800000	ADT 2.5 2C	A.105
1989810000	ADT 2.5 2C BL	A.66
1989830000	ADT 2.5 3C	A.67
1989830000	ADT 2.5 3C	A.105
1989840000	ADT 2.5 3C BL	A.67
1989860000	ADT 2.5 4C	A.68
1989860000	ADT 2.5 4C	A.105
1989870000	ADT 2.5 4C BL	A.68
1989890000	A2C 2.5 PE /DT/FS	A.60
1989890000	A2C 2.5 PE /DT/FS	A.67
1989890000	A2C 2.5 PE /DT/FS	A.105
1989900000	A2C 2.5 /DT/FS	A.60
1989900000	A2C 2.5 /DT/FS	A.67
1989900000	A2C 2.5 /DT/FS	A.105
1989910000	A2C 2.5 /DT/FS BL	A.67
1989930000	ADT 2.5 2C W/O DTLV	A.66
1989940000	ADT 2.5 3C W/O DTLV	A.68
1989950000	ADT 2.5 4C W/O DTLV	A.69
1989970000	AEP DT 2.5 3C	A.67
1989970000	AEP DT 2.5 3C	A.68
1989980000	AEP DT 2.5 4C	A.68
1989980000	AEP DT 2.5 4C	A.69

1990000000

1990140000	AEP AP13	B.104
1990140000	AEP AP13	B.105
1991780000	ALO 6	A.24
1991790000	A2C 6 BL	A.22
1991790000	A2C 6 BL	A.118
1991800000	A2C 6 OR	A.118
1991810000	A2C 6 PE	A.52
1991810000	A2C 6 PE	A.105
1991820000	A3C 6	A.22
1991820000	A3C 6	A.105
1991820000	A3C 6	A.118
1991830000	A3C 6 BL	A.22
1991830000	A3C 6 BL	A.118
1991840000	A3C 6 OR	A.118
1991850000	A3C 6 PE	A.52
1991850000	A3C 6 PE	A.105
1991860000	ATPG 4 M-R	A.7
1991860000	ATPG 4 M-R	A.8
1991860000	ATPG 4 M-R	A.11
1991860000	ATPG 4 M-R	A.12
1991860000	ATPG 4 M-R	A.19
1991860000	ATPG 4 M-R	A.20
1991860000	ATPG 4 M-R	A

Order No.	Type	Page
-----------	------	------

2040000000

2041180000	ATPG 2.5/5	A.6
2041180000	ATPG 2.5/5	A.7
2041180000	ATPG 2.5/5	A.8
2041180000	ATPG 2.5/5	A.9
2041180000	ATPG 2.5/5	A.10
2041180000	ATPG 2.5/5	A.11
2041180000	ATPG 2.5/5	A.17
2041180000	ATPG 2.5/5	A.18
2041180000	ATPG 2.5/5	A.19
2041180000	ATPG 2.5/5	A.34
2041180000	ATPG 2.5/5	A.35
2041180000	ATPG 2.5/5	A.36
2041180000	ATPG 2.5/5	A.37
2041180000	ATPG 2.5/5	A.42
2041180000	ATPG 2.5/5	A.43
2041180000	ATPG 2.5/5	A.44
2041180000	ATPG 2.5/5	A.47
2041180000	ATPG 2.5/5	A.48
2041180000	ATPG 2.5/5	A.49
2041180000	ATPG 2.5/5	A.66
2041180000	ATPG 2.5/5	A.67
2041180000	ATPG 2.5/5	A.68
2041180000	ATPG 2.5/5	A.69
2041180000	ATPG 2.5/5	A.103
2041180000	ATPG 2.5/5	A.115
2041180000	ATPG 2.5/5	B.252
2041180000	ATPG 2.5/5	B.256
2041180000	ATPG 2.5/5	B.257
2041180000	ATPG 2.5/5	B.278
2041180000	ATPG 2.5/5	B.282
2041180000	ATPG 2.5/5	B.284
2041180000	ATPG 2.5/5	B.285
2041180000	ATPG 2.5/5	B.286
2041180000	ATPG 2.5/5	B.287
2041190000	ATPG 2.5/3	A.6
2041190000	ATPG 2.5/3	A.7
2041190000	ATPG 2.5/3	A.8
2041190000	ATPG 2.5/3	A.9
2041190000	ATPG 2.5/3	A.10
2041190000	ATPG 2.5/3	A.11
2041190000	ATPG 2.5/3	A.17
2041190000	ATPG 2.5/3	A.18
2041190000	ATPG 2.5/3	A.19
2041190000	ATPG 2.5/3	A.34
2041190000	ATPG 2.5/3	A.36
2041190000	ATPG 2.5/3	A.37
2041190000	ATPG 2.5/3	A.38
2041190000	ATPG 2.5/3	A.39
2041190000	ATPG 2.5/3	A.40
2041190000	ATPG 2.5/3	A.41
2041190000	ATPG 2.5/3	A.42
2041190000	ATPG 2.5/3	A.43
2041190000	ATPG 2.5/3	A.44
2041190000	ATPG 2.5/3	A.45
2041190000	ATPG 2.5/3	A.46
2041190000	ATPG 2.5/3	A.47
2041190000	ATPG 2.5/3	A.48
2041190000	ATPG 2.5/3	A.49
2041190000	ATPG 2.5/3	A.66
2041190000	ATPG 2.5/3	A.67
2041190000	ATPG 2.5/3	A.68
2041190000	ATPG 2.5/3	A.69
2041190000	ATPG 2.5/3	A.103
2041190000	ATPG 2.5/3	A.115
2041190000	ATPG 2.5/3	A.287

2050000000

2051180000	A2C 4	A.19
2051180000	A2C 4	A.105
2051180000	A2C 4	A.118
2051210000	A2C 4 BL	A.19
2051210000	A2C 4 BL	A.118
2051220000	A2C 4 RD	A.118
2051230000	A2C 4 OR	A.118
2051240000	A3C 4	A.20
2051240000	A3C 4	A.61
2051240000	A3C 4	A.62
2051240000	A3C 4	A.105
2051240000	A3C 4	A.118
2051250000	A2C 4 YL	A.118
2051260000	A2C 4 GN	A.118
2051280000	A3C 4 BL	A.20
2051280000	A3C 4 BL	A.118
2051290000	A2C 4 WT	A.118
2051300000	A3C 4 RD	A.118
2051310000	A2C 4 BK	A.118
2051320000	A3C 4 OR	A.118
2051330000	A2C 4 LTGY	A.118
2051340000	A3C 4 YL	A.118
2051350000	A3C 4 GN	A.118
2051360000	A2C 4 PE	A.49
2051360000	A2C 4 PE	A.105
2051370000	A3C 4 WT	A.118
2051400000	A3C 4 BK	A.118
2051410000	A3C 4 PE	A.50

Order No.	Type	Page
-----------	------	------

2051410000	A3C 4 PE	A.61
2051410000	A3C 4 PE	A.62
2051410000	A3C 4 PE	A.105
2051460000	A3C 4 LTGY	A.118
2051500000	A4C 4	A.21
2051500000	A4C 4	A.105
2051500000	A4C 4	A.118
2051520000	A4C 4 BL	A.21
2051520000	A4C 4 BL	A.118
2051530000	A4C 4 RD	A.118
2051540000	A4C 4 OR	A.118
2051550000	A4C 4 YL	A.118
2051560000	A4C 4 PE	A.51
2051560000	A4C 4 PE	A.105
2051580000	A4C 4 GN	A.118
2051610000	A4C 4 WT	A.118
2051660000	A4C 4 BK	A.118
2051670000	A4C 4 LTGY	A.118
2051680000	AEP 2C 4	A.19
2051680000	AEP 2C 4	A.49
2051680000	AEP 2C 4	A.80
2051680000	AEP 2C 4	B.253
2051690000	AEP 2C 4 BL	A.15
2051690000	AEP 2C 4 BL	A.80
2051720000	AEP 3C 4	A.20
2051720000	AEP 3C 4	A.50
2051720000	AEP 3C 4	A.81
2051880000	AEP 3C 4 BL	A.20
2051880000	AEP 3C 4 BL	A.81
2051900000	AEP 4C 4	A.21
2051900000	AEP 4C 4	A.51
2051900000	AEP 4C 4	A.69
2051910000	AEP 4C 4 BL	A.21
2051910000	AEP 4C 4 BL	A.69

2060000000

2065120000	ALO 6 BL	A.24
------------	----------	------

2100000000

2108470000	ZQV 2.5N/2 RD	A.110
2108470000	ZQV 2.5N/2 RD	A.344
2108470000	ZQV 2.5N/2 RD	B.108
2108470000	ZQV 2.5N/2 RD	B.109
2108470000	ZQV 2.5N/2 RD	B.110
2108470000	ZQV 2.5N/2 RD	B.111
2108470000	ZQV 2.5N/2 RD	B.112
2108470000	ZQV 2.5N/2 RD	B.113
2108690000	ZQV 2.5N/3 RD	A.110
2108690000	ZQV 2.5N/3 RD	A.344
2108700000	ZQV 2.5N/4 RD	A.110
2108700000	ZQV 2.5N/4 RD	A.344
2108710000	ZQV 2.5N/5 RD	A.110
2108710000	ZQV 2.5N/5 RD	A.344
2108720000	ZQV 2.5N/6 RD	A.110
2108720000	ZQV 2.5N/6 RD	A.344
2108810000	ZQV 2.5N/7 RD	A.110
2108810000	ZQV 2.5N/7 RD	A.344
2108870000	ZQV 2.5N/8 RD	A.110
2108870000	ZQV 2.5N/8 RD	A.344
2108900000	ZQV 2.5N/9 RD	A.110
2108900000	ZQV 2.5N/9 RD	A.344
2108910000	ZQV 2.5N/10 RD	A.110
2108910000	ZQV 2.5N/10 RD	A.344
2108910000	ZQV 2.5N/10 RD	B.108
2108910000	ZQV 2.5N/10 RD	B.109
2108910000	ZQV 2.5N/10 RD	B.110
2108910000	ZQV 2.5N/10 RD	B.111
2108910000	ZQV 2.5N/10 RD	B.112
2108910000	ZQV 2.5N/10 RD	B.113
2108920000	ZQV 2.5N/20 RD	A.110
2108920000	ZQV 2.5N/20 RD	A.344
2109000000	ZQV 2.5N/50 RD	A.110
2109000000	ZQV 2.5N/50 RD	A.344

2110000000

2111230000	SAKQB 6/10	B.160
2111240000	SAKQS 6/2	B.160
2111240000	SAKQS 6/2	B.161
2111670000	SAKQS 6/4	B.160
2111670000	SAKQS 6/4	B.161

2120000000

2123000000	AMG PP	B.125
------------	--------	-------

2260000000

2289800000	KLBUE 4-6 Z/1	B.240
------------	---------------	-------

2330000000

2334730000	ADHB/8 WTL35	B.178
2334730000	ADHB/8 WTL35	B.179

Order No.	Type	Page
-----------	------	------

2420000000

2428510000	A3T 2.5	A.42
2428520000	A3T 2.5 BL	A.42
2428530000	A3T 2.5 FT-FT-PE	A.43
2428540000	A3T 2.5 VL	A.42
2428550000	A3T 2.5 PE	A.59
2428560000	AEP 3T 2.5	A.34
2428560000	AEP 3T 2.5	A.42
2428560000	AEP 3T 2.5	A.43
2428560000	AEP 3T 2.5	A.59
2428840000	A3T 2.5 NFT-PE	A.43
2428850000	A3T 2.5 VL BL	A.42
2428860000	AEP 3T 2.5 BL	A.34
2428860000	AEP 3T 2.5 BL	A.42
2428860000	AEP 3T 2.5 BL	A.43
2428860000	AEP 3T 2.5 BL	A.59
2428910000	AAP21 10 L0 RD	B.114
2428920000	AAP21 10 FE	B.114
2428930000	AAP21 4 LI RD	B.115
2428940000	AAP21 10 L0 BL	B.114
2428950000	AAP21 4 FS	B.116
2428960000	AAP21 4 LI BL	B.115
2428980000	AAP21 4 DT	B.116
2428990000	AAP22 10 L0 L0	B.118
2429000000	AAP22 10 FE L0	B.118
2429010000	AAP22 4 LFS	B.119
2429020000	AEP AP21	B.114
2429020000	AEP AP21	B.115
2429020000	AEP AP21	B.116
2429040000	AEP AP22	B.118
2429040000	AEP AP22	B.119
2429520000	WDU 2.5 GE/SW	B.262
2429850000	ADT 4 2C	A.69
2429850000	ADT 4 2C	A.105
2429860000	AFS 4 2C BK	A.61
2429860000	AFS 4 2C BK	A.105
2429870000	AFS 4 2C 10-36V BK	A.61
2429880000	ADT 4 2C BL	A.69

2430000000

2433820000	AEP MC 2.5	A.44
2433820000	AEP MC 2.5	B.94
2434340000	AMC 2.5	A.44
2434340000	AMC 2.5	B.94
2434350000	AFS 4 2C 30-70V BK	A.61
2434370000	AMC 2.5 800V	A.44
2434370000	AMC 2.5 800V	B.94
2434380000	AFS 4 2C 60-150V BK	A.61
2434390000	AFS 4 2C 100-250V BK	A.61
2436360000	WTR 4/ZZ STB/0.TNHE	A.310
2436380000	WTR 4/0.TNHE	A.309
2436390000	WTR 4 STB/0.TNHE	A.309
2436400000	WTR 4/ZR/0.TNHE	A.311
2436410000	WTR 4/ZR STB/0.TNHE	A.311
2436420000	WTR 4/ZZ/0.TNHE	A.310

2440000000

2445070000	WAD 12 MC NE WS	A.252
2445070000	WAD 12 MC NE WS	A.253
2445070000	WAD 12 MC NE WS	A.254
2445070000	WAD 12 MC NE WS	A.255
2445070000	WAD 12 MC NE WS	B.26
2445070000	WAD 12 MC NE WS	B.27
2445070000	WAD 12 MC NE WS	B.263
2445070000	WAD 12 MC NE WS	B.264
2445090000	WAD 12 MC B GE/SW	A.252
2445090000	WAD 12 MC B GE/SW	A.253
2445090000	WAD 12 MC B GE/SW	A.254
2445090000	WAD 12 MC B GE/SW	A.255
2445090000	WAD 12 MC B GE/SW	B.26
2445090000	WAD 12 MC B GE/SW	B.27
2445090000	WAD 12 MC B GE/SW	B.263
2445090000	WAD 12 MC B GE/SW	B.264
2448860000	DEKA 5/8 MM WS	A.22
2448860000	DEKA 5/8 MM WS	A.23
2448860000	DEKA 5/8 MM WS	A.24
2448860000	DEKA 5/8 MM WS	A.52
2448860000	DEKA 5/8 MM WS	A.53
2448860000	DEKA 5/8 MM WS	B.102
2448860000	DEKA 5/8 MM WS	B.103
2448860000	DEKA 5/8 MM WS	B.104
2448860000	DEKA 5/8 MM WS	B.105
2448860000	DEKA 5/8 MM WS	B.135
2448860000	DEKA 5/8 MM WS	B.137
2448860000	DEKA 5/8 MM WS	B.139
2448860000	DEKA 5/8 MM WS	B.253
2448860000	DEKA 5/8 MM WS	B.258
2448930000	WS-A 8/8 MM WS	A.22
2448930000	WS-A 8/8 MM WS	A.23
2448930000	WS-A 8/8 MM WS	A.24
2448930000	WS-A 8/8 MM WS	A.52
2448930000	WS-A 8/8 MM WS	A.53
2448930000	WS-A 8/8 MM WS	B.102
2448930000	WS-A 8/8 MM WS	B.103
2448930000	WS-A 8/8 MM WS	B.104
2448930000	WS-A 8/8 MM WS	B.105
2448930000	WS-A 8/8 MM WS	B.106

Order No.	Type	Page
-----------	------	------

2448930000	WS-A 8/8 MM WS
------------	----------------

Order No.	Type	Page
2466610000	AFS 2.5 CF 2C 12V BK	A.105
2469370000	A2T 1.5	A.32
2469370000	A2T 1.5	A.105
2469390000	A2T 1.5 FT-PE	A.33
2469400000	A2T 1.5 VL	A.32
2469410000	A2T 1.5 PE	A.56
2469410000	A2T 1.5 PE	A.105
2469420000	AEP 2T 1.5	A.32
2469420000	AEP 2T 1.5	A.33
2469420000	AEP 2T 1.5	A.56
2469420000	AEP 2T 1.5	A.74
2469420000	AEP 2T 1.5	A.75
2469420000	AEP 2T 1.5	B.297

2470000000

2471430000	A2T 1.5 BL	A.32
2471450000	A2T 1.5 VL BL	A.32
2471470000	AEP 2T 1.5 BL	A.32
2471470000	AEP 2T 1.5 BL	A.33
2471470000	AEP 2T 1.5 BL	A.74
2471470000	AEP 2T 1.5 BL	A.75
2471470000	AEP 2T 1.5 BL	B.297
2475310000	AE 35 SC/1 BK	B.38
2475310000	AE 35 SC/1 BK	B.39
2475310000	AE 35 SC/1 BK	B.42
2475310000	AE 35 SC/1 BK	B.43
2475310000	AE 35 SC/1 BK	B.46
2475310000	AE 35 SC/1 BK	B.48
2475310000	AE 35 SC/1 BK	C.21

2480000000

2482160000	APGTB 1.5 FT 2C/1	A.72
2482160000	APGTB 1.5 FT 2C/1	A.105
2482170000	APGTB 1.5 FT 2C/1 BL	A.72
2482180000	APGTB 1.5 FT 3C/1	A.73
2482180000	APGTB 1.5 FT 3C/1	A.105
2482190000	APGTB 1.5 FT 3C/1 BL	A.73
2482200000	APGTB 1.5 FT 4C/2	A.73
2482200000	APGTB 1.5 FT 4C/2	A.105
2482210000	APGTB 1.5 FT 4C/2 BL	A.73
2482220000	APGTB 1.5 PE 2C/1	A.72
2482220000	APGTB 1.5 PE 2C/1	A.105
2482230000	APGTB 1.5 PE 3C/1	A.73
2482230000	APGTB 1.5 PE 3C/1	A.105
2482240000	APGTB 1.5 PE 4C/2	A.74
2482240000	APGTB 1.5 PE 4C/2	A.105
2482250000	APG 1.5 L	A.72
2482250000	APG 1.5 L	A.73
2482250000	APG 1.5 L	A.75
2482250000	APG 1.5 L	A.88
2482260000	APG 1.5 L BL	A.88
2482270000	APG 1.5 L GN	A.88
2482280000	APG 1.5 MI	A.72
2482280000	APG 1.5 MI	A.73
2482280000	APG 1.5 MI	A.74
2482280000	APG 1.5 MI	A.75
2482280000	APG 1.5 MI	A.88
2482290000	APG 1.5 MI BL	A.88
2482300000	APG 1.5 MI GN	A.88
2482310000	APG 1.5 R	A.72
2482310000	APG 1.5 R	A.73
2482310000	APG 1.5 R	A.74
2482310000	APG 1.5 R	A.75
2482310000	APG 1.5 R	A.88
2482320000	APG 1.5 R BL	A.88
2482330000	APG 1.5 R GN	A.88
2482340000	APG 1.5/1	A.72
2482340000	APG 1.5/1	A.73
2482340000	APG 1.5/1	A.74
2482340000	APG 1.5/1	A.75
2482340000	APG 1.5/1	A.84
2482350000	APG 1.5/2	A.84
2482360000	APG 1.5/3	A.84
2482370000	APG 1.5/4	A.84
2482380000	APG 1.5/5	A.84
2482390000	APG 1.5/6	A.84
2482400000	APG 1.5/7	A.84
2482410000	APG 1.5/8	A.84
2482420000	APG 1.5/9	A.84
2482430000	APG 1.5/10	A.72
2482430000	APG 1.5/10	A.73
2482430000	APG 1.5/10	A.74
2482430000	APG 1.5/10	A.75
2482440000	APG 1.5/5-3BG-BLGN	A.84
2482450000	APG 1.5/4-3BG-BLGN	A.86
2482460000	APG 1.5/3-BG-BLGN	A.84
2482510000	AEP PGTB 1.5 4C/2	A.73
2482510000	AEP PGTB 1.5 4C/2	A.74
2482520000	AEP PGTB 1.5 4C/2 BL	A.73
2482530000	APGPC 1.5	A.84
2482530000	APGPC 1.5	A.86
2482530000	APGPC 1.5	A.89
2482720000	APGLE 1.5	A.84
2482720000	APGLE 1.5	A.86
2482720000	APGLE 1.5	A.89

Order No.	Type	Page
2482730000	APGSR 1.5	A.84
2482730000	APGSR 1.5	A.86
2482730000	APGSR 1.5	A.88
2482740000	APGSR 1.5 -4P	A.84
2482740000	APGSR 1.5 -4P	A.86
2482740000	APGSR 1.5 -4P	A.88
2482750000	APGSR 1.5 -8P	A.84
2482750000	APGSR 1.5 -8P	A.86
2482750000	APGSR 1.5 -8P	A.88
2484220000	WS 12/9.5-11 MC NE WS	A.361
2484220000	WS 12/9.5-11 MC NE WS	A.362
2484220000	WS 12/9.5-11 MC NE WS	B.180
2484220000	WS 12/9.5-11 MC NE WS	B.181
2485840000	APGTB 1.5 2T 4C/2	A.74
2485840000	APGTB 1.5 2T 4C/2	A.105
2485850000	APGTB 1.5 2T 4C/2 BL	A.74
2485860000	APGTB 1.5 2T FT-PE 4C/2	A.75
2485870000	APGTB 1.5 2T PE 4C/2	A.75
2485870000	APGTB 1.5 2T PE 4C/2	A.105
2485920000	APGTB 1.5 2T VL 4C/2	A.75
2485930000	APGTB 1.5 2T VL 4C/2 BL	A.75
2485980000	MCV APG 1.5	A.84
2485980000	MCV APG 1.5	A.86
2485980000	MCV APG 1.5	A.88
2486640000	AEP 3C 4 BK	A.61
2486640000	AEP 3C 4 BK	A.62
2486660000	AEP 4C 2.5 BK	A.60
2488970000	APP 1	A.105
2489090000	APP 2	A.105
2489100000	APP 3	A.105
2489100000	APP 4	A.105

2490000000

2490360000	A2C 10	A.25
2490370000	A2C 10 BL	A.25
2490380000	AEP 2C 10/16	A.25
2490380000	AEP 2C 10/16	A.26
2490380000	AEP 2C 10/16	A.53
2490380000	AEP 2C 10/16	A.54
2490380000	AEP 2C 10/16	B.253
2490390000	AEP 2C 10/16 BL	A.25
2490390000	AEP 2C 10/16 BL	A.26
2490440000	A2C 10 PE	A.53
2490510000	A3C 10 BL	A.25
2490520000	A3C 10	A.25
2490530000	AEP 3C 10/16	A.25
2490530000	AEP 3C 10/16	A.26
2490530000	AEP 3C 10/16	A.53
2490530000	AEP 3C 10/16	A.54
2490540000	AEP 3C 10/16 BL	A.25
2490540000	AEP 3C 10/16 BL	A.26
2490590000	A3C 10 PE	A.53
2494000000	A2C 16	A.26
2494010000	A2C 16 PE	A.54
2494020000	A3C 16 PE	A.54
2494080000	A3C 16 BL	A.26
2494090000	A3C 16	A.26
2494100000	A2C 16 BL	A.26
2496040000	HV4000/2-M12 F	A.385
2496050000	HV4000/3-M12 F	A.385
2497250000	ZQV 10N/2	A.25
2497250000	ZQV 10N/2	A.111
2497250000	ZQV 10N/2	B.279
2497250000	ZQV 10N/2	B.283
2497290000	ZQV 16N/2	A.26
2497290000	ZQV 16N/2	A.111

2500000000

2502280000	ALO 16	A.27
2502320000	ALO 16 BL	A.27
2502530000	WPD 130 1X50/1X50 GY	B.38
2502540000	WPD 130 1X50/1X50 BL	B.38
2502550000	WPD 130 1X50/1X50 GN	B.38
2502560000	WPD 130 1X50/1X50 BN	B.38
2502570000	WPD 130 1X50/1X50 BK	B.38
2502580000	WPD 230 2X95/2X95 GY	B.38
2502590000	WPD 230 2X50/2X50 BL	B.38
2502600000	WPD 230 2X50/2X50 GN	B.38
2502610000	WPD 230 2X50/2X50 BN	B.38
2502620000	WPD 330 3X50/3X50 3XGY	B.39
2502640000	WPD 330 3X50/3X50 1XGY/1XBL/1XGN	B.39
2502650000	WPD 330 3X50/3X50 1XBN/1XBK/1XGN	B.39
2502660000	WPD 131 1X95/1X95 BL	B.42
2502670000	WPD 131 1X95/1X95 GN	B.42
2502680000	WPD 131 1X95/1X95 BN	B.42
2502690000	WPD 131 1X95/1X95 BK	B.42
2502700000	WPD 231 2X95/2X95 GY	B.42
2502710000	WPD 231 2X95/2X95 BL	B.42
2502720000	WPD 231 2X95/2X95 GN	B.42
2502730000	WPD 231 2X95/2X95 BN	B.42
2502740000	WPD 231 2X95/2X95 BK	B.42
2502750000	WPD 132 1X185/1X185 GY	B.46
2502760000	WPD 132 1X185/1X185 BL	B.46
2502770000	WPD 132 1X185/1X185 GN	B.46
2502780000	WPD 132 1X185/1X185 BN	B.46
2502790000	WPD 132 1X185/1X185 BK	B.46
2502800000	WPD 232 2X185/2X185 GY	B.46

Order No.	Type	Page
2502810000	WPD 232 2X185/2X185 BL	B.46
2502820000	WPD 232 2X185/2X185 GN	B.46
2502830000	WPD 232 2X185/2X185 BN	B.46
2502840000	WPD 232 2X185/2X185 BK	B.46
2502850000	WPD 133 1X300/1X300 GY	B.48
2502860000	WPD 133 1X300/1X300 BL	B.48
2502870000	WPD 133 1X300/1X300 GN	B.48
2502880000	WPD 133 1X300/1X300 BN	B.48
2502890000	WPD 133 1X300/1X300 BK	B.48
2502900000	WPD 233 2X300/2X300 GY	B.48
2502910000	WPD 233 2X300/2X300 BL	B.48
2502920000	WPD 233 2X300/2X300 GN	B.48
2502930000	WPD 233 2X300/2X300 BN	B.48
2502940000	WPD 233 2X300/2X300 BK	B.48
2502950000	WPD 230 2X50/2X50 BK	B.38
2503090000	WPD 131 1X95/1X95 GY	B.42
2503330000	WPDPC X30 GY	B.38
2503330000	WPDPC X30 GY	B.39
2503370000	WPDPC X31 GY	B.42
2503370000	WPDPC X31 GY	B.43
2503380000	WPDPC X32 GY	B.46
2503390000	WPDPC X33 GY	B.48
2503650000	AAP11 6 LO OR	B.102
2503870000	AAP11 6/6X1.5 LO-LI OR	B.103
2503880000	AAP12 2.5 LI OR	B.109
2503890000	AAP12 10/4X2.5 LO-LI OR	B.109
2503900000	AAP12 10 LO OR	B.108
2503910000	AAP11 1.5 LI OR	B.103
2506090000	SET AAP11 6/1.5/12C	B.106
2506340000	SET AAP13 6/1.5/12C	B.107
2506350000	SET AAP12 10/2.5/10C	B.112
2506360000	SET AAP14 10/2.5/10C	B.113
2506370000	SET AAP11 6/1.5/24C	B.106
2506380000	SET AAP13 6/1.5/24C	B.107
2508000000	A2C 2.5 DBL	A.118
2508020000	A2C 1.5 RD	A.118
2508030000	A2C 2.5 BR	A.118
2508160000	A2C 1.5 WT	A.118
2508170000	A2C 1.5 BK	A.118
2508180000	A2C 1.5 DBL	A.118
2508190000	A2C 1.5 YL	A.118
2508200000	A2C 1.5 BR	A.118
2508210000	A2C 1.5 GN	A.118
2508220000	A2C 1.5 LTGY	A.118

2510000000

2518250000	WPD 104 1X25+1X16/2X16+3X10 BL	B.68
2518330000	WPD 204 2X25/4X16+6X10 2XBL	B.68
2518340000	WPD 304 3X25/6X16+9X10 3XBL	B.69
2518540000	WPD 105 1X35+1X16/2X25+3X16 BL	B.72
2518570000	WPD 106 1X70/2X25+3X16 BL	B.76
2519470000	WPD 205 2X35/4X25+6X16 2XBL	B.72
2519480000	WPD 108 1X120/2X35+3X25+4X16 BL	B.80
2519490000	WPD 109 1X185/2X35+3X25+4X16 BL	B.82

2520000000

2521730000	WPD 107 1X95/2X35+8X25 BL	B.78
2521770000	WPD 305 3X35/6X25+9X16 3XBL	B.73
2522720000	AAP11 6 LO BL/OR	B.102
2522830000	AAP11 6/6X1.5 LO-LI BL/OR	B.103
2522840000	AAP12 2.5 LI BL/OR	B.109
2522850000	AAP12 10/4X2.5 LO-LI BL/OR	B.109
2522860000	AAP12 10 LO BL/OR	B.108
2522870000	AAP11 1.5 LI BL/OR	B.103

2530000000

2531290000	A2T 2.5 3C	A.36
2531300000	A2T 2.5 3C FT-PE	A.37
2531310000	A2T 2.5 3C VL	A.36
2531320000	A2T 2.5 3C PE	A.58
2531510000	A2T 2.5 3C BL	A.36
2531530000	A2T 2.5 3C VL BL	A.36
2532690000	AEP 2T 2.5 3C	A.36
2532690000	AEP 2T 2.5 3C	A.58
2532700000	AEP 2T 2.5 3C BL	A.36
2534230000	A3C 1.5 BK	A.118
2534260000	A4C 1.5 BK	A.118
2534290000	A3C 4 BR	A.118
2534		

Order No.	Type	Page
2551530000	A2C 35 FE	B.259
2551540000	A2C 35 3FT-NPE	B.11
2551550000	A2C 35 DM	A.28
2551550000	A2C 35 DM	B.9
2552090000	A2C 35 BL	A.28
2552090000	A2C 35 BL	B.8
2552100000	A2C 35 3FT	B.10
2552110000	A2C 35 3FTFE	B.10
2552120000	A2C 35 3FTPE	B.11
2552130000	A2C 35 3FT-N	B.10
2552140000	A2C 35 3FT-NFE	B.10
2552150000	A2C 35 BL DM	A.28
2552150000	A2C 35 BL DM	B.9
2552160000	A2C 35 FE DM	B.9
2552160000	A2C 35 FE DM	B.259
2552170000	A2C 35 3FT DM	B.11
2552180000	A2C 35 3FTFE DM	B.11
2552190000	A2C 35 3FT-N DM	B.11
2552200000	A2C 35 3FT-NFE DM	B.11

2560000000

2561900000	WFS 4	A.284
2561960000	WFS 4 100-250V	A.285
2561970000	WFS 4 60-150V	A.285
2561990000	WFS 4 30-70V	A.285
2562000000	WFS 4 BL	A.284
2562050000	WFS 4 DB	A.284
2562070000	WFS 4 10-36V	A.285
2562590000	WSI 4	A.287
2562660000	ZQV 35N-16	A.28
2562660000	ZQV 35N-16	A.111
2562660000	ZQV 35N-16	B.8
2562660000	ZQV 35N-16	B.9
2562660000	ZQV 35N-16	B.10
2562660000	ZQV 35N-16	B.11
2562660000	ZQV 35N-16	B.12
2562660000	ZQV 35N-16	B.259
2562670000	ZQV 35N-10	A.28
2562670000	ZQV 35N-10	A.111
2562670000	ZQV 35N-10	B.8
2562670000	ZQV 35N-10	B.9
2562670000	ZQV 35N-10	B.10
2562670000	ZQV 35N-10	B.11
2562670000	ZQV 35N-10	B.12
2562670000	ZQV 35N-10	B.259
2563830000	ST 4000/S M8	A.382
2563860000	ST 4000/S M10	A.382
2563880000	ST 4000/L M12	A.383
2563890000	ST 4000/S P150	A.382
2563900000	ST 4000/L P180	A.383
2563910000	ST 4000/S E150	A.382
2563920000	ST 4000/L E180	A.383
2563930000	ST 4000/S C130	A.382
2563940000	ST 4000/L C160	A.383
2563950000	ST 4000/S CB M8/4	A.382
2563960000	ST 4000/S CB M10/4	A.382
2563970000	ST 4000/S CB M10/6	A.382
2564000000	ST 4000/L CB M12/6	A.383
2564010000	ST 4000/S J2 M8	A.382
2564020000	ST 4000/S J3 M8	A.382
2564100000	ST 4000/L J2 M12	A.383
2564110000	ST 4000/L J3 M12	A.383
2564120000	ST 4000/L J4 M12	A.383
2564170000	ST 4000/S S150	A.382
2564180000	ST 4000/L S180	A.383
2564350000	WSI 4/LD 10-36V AC/DC	A.287
2564360000	WSI 4/LD 30-70V AC/DC	A.287
2564370000	WSI 4/LD 60-150V AC/DC	A.287
2564380000	WSI 4/LD 140-250V AC/DC	A.287

2570000000

2570240000	AEB 35 SCL/1 VO DL	A.102
2570240000	AEB 35 SCL/1 VO DL	A.117
2570250000	AEB 35 SCL/1 VO BK DL	A.102
2570250000	AEB 35 SCL/1 VO BK DL	A.117
2570260000	AEB 35 SCL/1 VO GY DL	A.102
2570260000	AEB 35 SCL/1 VO GY DL	A.117
2579570000	AIO21 1.5 SO OR	B.184
2579580000	AIO21 1.5 SP-PE OR	B.185
2579610000	AIO21 1.5 SI OR	B.184
2579620000	AIO23 1.5 2SI OR	B.185
2579640000	AIO22 1.5 SI-PE OR	B.185

2580000000

2581250000	A2T 2.5 SNAPMARK	A.34
2581280000	A2T 2.5 SNAPMARK BL	A.34
2581690000	AAP21 10 LD OR	B.114
2581700000	AAP21 4 LU OR	B.115
2581710000	AAP21 4 DT OR	B.116
2581720000	AAP21 4 FS OR	B.116
2581790000	AAP21 4 FS 100-250V OR	B.116
2581800000	AAP21 10 LD BL/OR	B.115
2582520000	AAP21 4 DT BL/OR	B.116
2582530000	AAP21 4 LU BL/OR	B.115
2583090000	AAC 35 2X6	A.28
2583090000	AAC 35 2X6	B.8

Order No.	Type	Page
2583090000	AAC 35 2X6	B.9
2583090000	AAC 35 2X6	B.10
2583090000	AAC 35 2X6	B.11
2583090000	AAC 35 2X6	B.12
2583170000	AAC 35 2X6 BL	A.28
2583170000	AAC 35 2X6 BL	B.8
2583170000	AAC 35 2X6 BL	B.9
2583170000	AAC 35 2X6 BL	B.10
2583170000	AAC 35 2X6 BL	B.11
2583170000	AAC 35 2X6 BL	B.12
2583180000	AAC 35 2X6 GN-YL	A.28
2583180000	AAC 35 2X6 GN-YL	A.55
2583180000	AAC 35 2X6 GN-YL	B.8
2583180000	AAC 35 2X6 GN-YL	B.9
2583180000	AAC 35 2X6 GN-YL	B.10
2583180000	AAC 35 2X6 GN-YL	B.11
2583180000	AAC 35 2X6 GN-YL	B.12
2583190000	AAC 35 2X6 BK-YL	A.28
2583190000	AAC 35 2X6 BK-YL	B.8
2583190000	AAC 35 2X6 BK-YL	B.9
2583190000	AAC 35 2X6 BK-YL	B.10
2583190000	AAC 35 2X6 BK-YL	B.11
2583190000	AAC 35 2X6 BK-YL	B.12

2600000000

2603740000	WPD 113 1X185+1X150/8X35 GY	B.86
2603750000	WPD 113 1X185+1X150/8X35 BL	B.86
2603790000	WPD 111 1X95/4X35 GY	B.84
2603800000	WPD 111 1X95/4X35 BL	B.84
2603810000	WPD 110 1X70+1X35/6X16 GY	B.56
2603820000	WPD 110 1X70+1X35/6X16 BL	B.56
2603830000	WPD 110 1X70+1X35/6X16 GN	B.56
2603840000	WBDD 16 GY	C.14
2603850000	WBDD 16 BL	C.14
2603860000	WBDD 16 GN	C.14

2610000000

2614100000	AAP11 1.5 LU GN/OR	B.103
2614110000	AAP12 2.5 LU GN/OR	B.109
2614930000	SRL 3	A.361
2614940000	SRL 4	A.361
2614950000	SRL 4 STB	A.362
2614960000	SRL 6	A.362
2614970000	SDL 4 FT	B.181
2614980000	SDL 4	B.181
2614990000	SEP SRL 3	A.361
2615000000	SEP SRL 4	A.362
2615010000	SEP SRL 6	A.362
2615020000	SEP SDL 4	B.180
2615020000	SEP SDL 4	B.181
2615030000	SDV 3/2	A.361
2615040000	SDV 3/3	A.361
2615050000	SDV 3/4	A.361
2615070000	SDV 3/10	A.361
2615080000	SDV 6/2	A.362
2615090000	SDV 6/3	A.362
2615100000	SDV 6/4	A.362
2615110000	SQB 3/2	A.361
2615120000	SQB 3/3	A.361
2615130000	SQB 3/4	A.361
2615140000	SQB 4/2	A.361
2615140000	SQB 4/2	A.362
2615140000	SQB 4/2	B.181
2615150000	SQB 4/3	A.361
2615150000	SQB 4/3	A.362
2615150000	SQB 4/3	B.181
2615160000	SQB 4/4	A.361
2615160000	SQB 4/4	A.362
2615160000	SQB 4/4	B.181
2615190000	SROB 3/2	A.361
2615200000	SROB 3/3	A.361
2615210000	SROB 3/4	A.361
2615220000	SROB 4/2	A.361
2615220000	SROB 4/2	A.362
2615220000	SROB 4/2	B.181
2615230000	SROB 4/3	A.361
2615230000	SROB 4/3	A.362
2615230000	SROB 4/3	B.181
2615240000	SROB 4/4	A.361
2615240000	SROB 4/4	A.362
2615240000	SROB 4/4	B.181
2615250000	SQS 4/2	A.362
2615250000	SQS 4/2	B.180
2615250000	SQS 4/2	B.181
2615260000	SQS 4/4	A.362
2615260000	SQS 4/4	B.180
2615260000	SQS 4/4	B.181
2615270000	SSI 4	B.180
2615330000	SAKQB 6/2	B.180
2615330000	SAKQB 6/2	B.161
2615340000	SAKQB 6/3	B.160
2615360000	SAKQB 6/4	B.160
2615360000	SAKQB 6/4	B.161
2619410000	AAP12 10 LD GN/OR	A.108
2619890000	WS-A 8/10 MM WS	B.279
2619890000	WS-A 8/10 MM WS	B.281

Order No.	Type	Page
2619890000	WS-A 8/10 MM WS	B.283
2619900000	WS-A 8/12 MM WS	A.54
2619910000	WS-A 8/16 MM WS	A.28
2619910000	WS-A 8/16 MM WS	A.29
2619910000	WS-A 8/16 MM WS	A.30
2619910000	WS-A 8/16 MM WS	A.31
2619910000	WS-A 8/16 MM WS	A.55
2619910000	WS-A 8/16 MM WS	A.56
2619910000	WS-A 8/16 MM WS	B.8
2619910000	WS-A 8/16 MM WS	B.9
2619910000	WS-A 8/16 MM WS	B.10
2619910000	WS-A 8/16 MM WS	B.11
2619910000	WS-A 8/16 MM WS	B.12
2619910000	WS-A 8/16 MM WS	B.26
2619910000	WS-A 8/16 MM WS	B.27
2619910000	WS-A 8/16 MM WS	B.28
2619910000	WS-A 8/16 MM WS	B.29
2619910000	WS-A 8/16 MM WS	B.260
2619910000	WS-A 8/16 MM WS	B.261

2620000000

2623550000	A2T 2.5 3C N-PE	A.37
2623910000	AAP13 6 LD LD OR	B.105
2623920000	AAP13 1.5 LH/LR	B.105
2623930000	FB 16-50	B.250

2630000000

2634950000	ZQV 35N/2	A.28
2634950000	ZQV 35N/2	A.111
2634950000	ZQV 35N/2	B.8
2634950000	ZQV 35N/2	B.9
2634950000	ZQV 35N/2	B.10
2634950000	ZQV 35N/2	B.11
2634950000	ZQV 35N/2	B.12
2634950000	ZQV 35N/2	B.259
2635520000	AAM 1.5 YE FLASH	A.116
2635550000	AAM 2.5 YE FLASH	A.116
2635560000	AAM 4 YE FLASH	A.116
2635570000	AAM 6 YE FLASH	A.116
2635580000	AAM 10 YE FLASH	A.116
2635590000	AAM 16 YE FLASH	A.116
2635600000	AAM 35-185 YE FLASH	A.28
2635600000	AAM 35-185 YE FLASH	A.29
2635600000	AAM 35-185 YE FLASH	A.30
2635600000	AAM 35-185 YE FLASH	A.31
2635600000	AAM 35-185 YE FLASH	A.55
2635600000	AAM 35-185 YE FLASH	A.56
2635600000	AAM 35-185 YE FLASH	B.8
2635600000	AAM 35-185 YE FLASH	B.9
2635600000	AAM 35-185 YE FLASH	B.10
2635600000	AAM 35-185 YE FLASH	B.11
2635600000	AAM 35-185 YE FLASH	B.12
2635600000	AAM 35-185 YE FLASH	B.16
2635600000	AAM 35-185 YE FLASH	B.17
2635600000	AAM 35-185 YE FLASH	B.18
2635600000	AAM 35-185 YE FLASH	B.19
2635600000	AAM 35-185 YE FLASH	B.20
2635600000	AAM 35-185 YE FLASH	B.21
2635600000	AAM 35-185 YE FLASH	B.22
2635600000	AAM 35-185 YE FLASH	B.23
2635600000	AAM 35-185 YE FLASH	B.24
2635600000	AAM 35-185 YE FLASH	B.259
2635600000	AAM 35-185 YE FLASH	B.260
2635600000	AAM 35-185 YE FLASH	B.261

2650000000

2652200000	A2T 1.5 KNX RD-BK	B.297
2652210000	A2T 1.5 KNX WT-YL	B.297
2657770000	G-1L106/10	C.25
2657780000	G-1L106/16	C.25
2657790000	G-1L160/10	C.25
2657800000	G-1L160/16	C.25
2657810000	G-1L210/10	C.25
2657820000	G-1L210/16	C.25
2657830000	G-1L268/10	C.25
2657840000	G-1L268/16	C.25
2657850000	G-1L320/10	C.25
2657860000	G-1L320/16	C.25
2657870000	G-1L1000/10	C.25
2657880000	G-1L1000/16	C.25
2657890000	G-1L+9-1000/10	C.25
2657900000	G-1L+9-1000/16	C.25
2657910000	G-1L27-1000/10	C.25
2657920000	G-1L27-1000/16	C.25
2657930000	S-1L106/10	C.26
2657940000	S-1L106/16	C.26
2657950000	S-1L160/10	C.26
2657960000	S-1L160/16	C.26
2657970000	S-1L210/10	C.26

Order No.	Type	Page
2657980000</		

Order No.	Type	Page
2675290000	AFS 4 2C 100-250V DLBK	A.102
2675300000	AAP11 6 LO DL DR	A.102
2675310000	AAP11 6 LO DL OR	A.102
2675320000	AAP11 6 LO DL BL	A.102
2675330000	AAP1 1 6 LO DL BL/OR	A.102
2675340000	AAP11 1 5 LI DL RD	A.102
2675350000	AAP11 1 5 LI DL OR	A.102
2675360000	AAP11 1 5 LI DL BL	A.102
2675370000	AAP11 1 5 LI DL BL/OR	A.102
2675380000	AAP11 6/6X1.5 LO-LJ DL BL	A.102
2675390000	AAP11 6/6X1.5 LO-LJ DL DR	A.102
2675400000	AAP11 6/6X1.5 LO-LJ DL OR	A.102
2675410000	AAP11 6/6X1.5 LO-LJ DL BL/OR	A.102
2675420000	AAP12 10 LO DL DR	A.102
2675430000	AAP12 10 LO DL OR	A.102
2675440000	AAP12 10 LO DL BL	A.102
2675450000	AAP12 10 LO DL BL/OR	A.102
2675460000	AAP12 2.5 LI DL RD	A.102
2675470000	AAP12 2.5 LI DL OR	A.102
2675480000	AAP12 2.5 LI DL BL	A.102
2675490000	AAP12 2.5 LI DL BL/OR	A.102
2675500000	AAP12 10/4X2.5 LO-LJ DL RD	A.102
2675510000	AAP12 10/4X2.5 LO-LJ DL OR	A.102
2675520000	AAP12 10/4X2.5 LO-LJ DL BL/OR	A.102
2675530000	AAP12 10/4X2.5 LO-LJ DL BL	A.102
2675540000	AAP13 6 LO LO DL	A.102
2675550000	AAP13 1.5 LI-LJ DL	A.102
2675560000	AAP14 10 LO-LJ DL	A.102
2675570000	AAP14 2.5 LI-LJ DL	A.102
2675580000	AIO21 1.5 SI DL	A.102
2675590000	AIO21 1.5 SO DL	A.102
2675600000	AIO21 1.5 SO-PE DL	A.102
2675610000	AIO22 1.5 SI-PE DL	A.102
2675620000	AIO23 1.5 2SI DL	A.102
2675630000	AIO21 1.5 SI DL OR	A.102
2675640000	AIO21 1.5 SO DL OR	A.102
2675650000	AIO21 1.5 SO-PE DL OR	A.102
2675660000	AIO22 1.5 SI-PE DL OR	A.102
2675670000	AIO23 1.5 2SI DL OR	A.102
2675680000	APGTB 1.5 FT 2C/1 DL	A.102
2675690000	APGTB 1.5 FT 2C/1 DL BL	A.102
2675700000	APGTB 1.5 FT 2C/1 DL DR	A.102
2675710000	APGTB 1.5 FT 3C/1 DL	A.102
2675720000	APGTB 1.5 FT 3C/1 DL BL	A.102
2675730000	APGTB 1.5 PE 3C/1 DL	A.102
2675740000	APGTB 1.5 FT 4C/2 DL	A.102
2675750000	APGTB 1.5 FT 4C/2 DL BL	A.102
2675760000	APGTB 1.5 PE 4C/2 DL	A.102
2675770000	APGTB 1.5 2T 4C/2 DL	A.102
2675780000	APGTB 1.5 2T 4C/2 DL BL	A.102
2675790000	APGTB 1.5 2T FT-PE 4C/2 DL	A.102
2675800000	APGTB 1.5 2T PE 4C/2 DL	A.102
2675810000	APGTB 1.5 2T VL 4C/2 DL	A.102
2675820000	APGTB 2.5 FT 2C/1 DL	A.102
2675830000	APGTB 2.5 FT 2C/1 DL BL	A.102
2675840000	APGTB 2.5 PE 2C/1 DL	A.102
2675850000	APGTB 2.5 FT 3C/1 DL	A.102
2675860000	APGTB 2.5 FT 3C/1 DL BL	A.102
2675870000	APGTB 2.5 PE 3C/1 DL	A.102
2675880000	APGTB 2.5 FT 4C/2 DL	A.102
2675890000	APGTB 2.5 FT 4C/2 DL BL	A.102
2675900000	APGTB 2.5 PE 4C/2 DL	A.102
2675910000	APGTB 2.5 2T 4C/2 DL	A.102
2675920000	APGTB 2.5 2T 4C/2 DL BL	A.102
2675930000	APGTB 2.5 2T FT-PE 4C/2 DL	A.102
2675940000	APGTB 2.5 2T PE 4C/2 DL	A.102
2675950000	APGTB 2.5 2T VL 4C/2 DL	A.102
2675960000	APGTB 4 FT 2C/1 DL	A.102
2675970000	APGTB 4 FT 2C/1 DL BL	A.102
2675980000	APGTB 4 PE 2C/1 DL	A.102
2675990000	APGTB 4 FT 3C/1 DL	A.102
2676000000	APGTB 4 FT 3C/1 DL BL	A.102
2676010000	APGTB 4 PE 3C/1 DL	A.102
2676020000	APGTB 4 FT 4C/2 DL	A.102
2676030000	APGTB 4 FT 4C/2 DL BL	A.102
2676040000	APGTB 4 PE 4C/2 DL	A.102
2676050000	APGTB 4 2T 4C/2 DL	A.102
2676060000	APGTB 4 2T 4C/2 DL BL	A.102
2676070000	APGTB 4 2T FT-PE 4C/2 DL	A.102
2676080000	APGTB 4 2T PE 4C/2 DL	A.102
2676090000	APGTB 4 2T VL 4C/2 DL	A.102

2680000000

2682080000	SNAPMARK 1.5	A.32
2682080000	SNAPMARK 1.5	A.33
2682080000	SNAPMARK 1.5	A.40
2682080000	SNAPMARK 1.5	A.41
2682080000	SNAPMARK 1.5	A.56
2682080000	SNAPMARK 1.5	A.57
2682080000	SNAPMARK 1.5	A.59
2682080000	SNAPMARK 1.5	A.74
2682080000	SNAPMARK 1.5	A.75
2682080000	SNAPMARK 1.5	A.117
2683430000	AAP11 6 LO WT	B.102
2683440000	AAP11 1 5 LI WT	B.103
2683450000	AAP12 10 LO WT	B.108
2683460000	AAP12 2.5 LI WT	B.109

Order No.	Type	Page
-----------	------	------

2690000000

2690440000	AEB ITB 2.5/4 BB BL	B.278
2690440000	AEB ITB 2.5/4 BB BL	B.279
2690440000	AEB ITB 2.5/4 BB BL	B.280
2690440000	AEB ITB 2.5/4 BB BL	B.281
2690440000	AEB ITB 2.5/4 BB BL	B.282
2690440000	AEB ITB 2.5/4 BB BL	B.283
2690440000	AEB ITB 2.5/4 BB BL	B.284
2690440000	AEB ITB 2.5/4 BB BL	B.285
2690440000	AEB ITB 2.5/4 BB BL	B.286
2690440000	AEB ITB 2.5/4 BB BL	B.287
2690440000	AEB ITB 2.5/4 BB BL	B.288
2690440000	AEB ITB 2.5/4 BB BL	B.289
2690440000	AEB ITB 2.5/4 BB BL	B.290
2690440000	AEB ITB 2.5/4 BB BL	B.291
2690440000	AEB ITB 2.5/4 BB BL	B.292
2690440000	AEB ITB 2.5/4 BB BL	B.293
2690460000	A2C 2.5 FE WT	B.251
2690460000	A2C 2.5 FE WT	B.252
2690470000	A4C 2.5 FE WT	B.251
2690470000	A4C 2.5 FE WT	B.252
2694060000	A2C 95/120	B.18
2694070000	A2C 95/120 BL	B.19
2694070000	A2C 95/120 BL	B.28
2694080000	A2C 95/120 FE	B.18
2694080000	A2C 95/120 FE	B.261
2694090000	A2C 95/120 PE	B.19
2694090000	A2C 95/120 PE	B.56
2694100000	A2C 95/120 3FT-NFE	B.22
2694120000	A2C 95/120 3FT-N	B.22
2694130000	A2C 95/120 3FT-FE	B.22
2694140000	A2C 95/120 3FT	B.22
2694150000	A2C 95/120-DM	B.30
2694160000	A2C 95/120-DM	B.19
2694160000	A2C 95/120 BL-DM	A.30
2694160000	A2C 95/120 BL-DM	B.19
2694170000	A2C 95/120 FE-DM	B.19
2694170000	A2C 95/120 FE-DM	B.261
2694180000	A2C 95/120 3FT-NFE-DM	B.23
2694200000	A2C 95/120 3FT-N-DM	B.23
2694220000	A2C 95/120 3FT-FE-DM	B.23
2694230000	A2C 95/120 3FT-DM	B.23
2694250000	Z0V 95/120M/2	A.92
2694250000	Z0V 95/120M/2	A.30
2694250000	Z0V 95/120M/2	A.112
2694250000	Z0V 95/120M/2	B.18
2694250000	Z0V 95/120M/2	B.19
2694250000	Z0V 95/120M/2	B.24
2694260000	Z0V 95/120M/3	A.261
2694260000	Z0V 95/120M/3	A.30
2694260000	Z0V 95/120M/3	A.112
2694260000	Z0V 95/120M/3	B.18
2694260000	Z0V 95/120M/3	B.19
2694260000	Z0V 95/120M/3	B.24
2694260000	Z0V 95/120M/3	B.261

2700000000

2704330000	A2T 2.5 EM1 D/0	A.92
2704340000	A2T 2.5 EM3 D/0	A.92
2704360000	A2T 2.5 EM2 D/0	A.93
2704370000	A2T 2.5 EM1 D/1	A.93
2704380000	A2T 2.5 EM1 D/2	A.93
2704390000	A2T 2.5 EM2 D/5	A.94
2704400000	A2T 2.5 EM2 D/6	A.94
2704410000	A2T 2.5 EM1 24VUC LED RD/1	A.95
2705010000	RAILLASER	A.100

2710000000

2710070000	ATTB 6	B.134
2710070000	ATTB 6	B.135
2710080000	ATTB 6 PE	B.134
2710080000	ATTB 6 PE	B.135
2710080000	ATTB 6 PE	B.145
2710090000	WTTB 6	B.136
2710090000	WTTB 6	B.137
2710090000	WTTB 6	B.138
2710100000	WTTB 6 PE	B.136
2710100000	WTTB 6 PE	B.137
2710100000	WTTB 6 PE	B.138
2710100000	WTTB 6 PE	B.142
2710100000	WTTB 6 PE	B.143
2710100000	WTTB 6 PE	B.145
2710110000	HTTB 6	B.139
2710120000	HTTB 6 PE	B.139
2710120000	HTTB 6 PE	B.145
2710130000	CH TTb	B.135
2710130000	CH TTb	B.137
2710130000	CH TTb	B.139
2710140000	CP TTb	B.135
2710140000	CP TTb	B.137
2710140000	CP TTb	B.139
2710150000	CS TTb	B.135
2710150000	CS TTb	B.137
2710150000	CS TTb	B.139
2710170000	EP TTb 6	B.134

Order No.	Type	Page
-----------	------	------

2710170000	EP TTb 6	B.135
2710170000	EP TTb 6	B.136
2710170000	EP TTb 6	B.137
2710170000	EP TTb 6	B.138
2710170000	EP TTb 6	B.139
2710190000	SCCB TTb 6/2	B.134
2710190000	SCCB TTb 6/2	B.135
2710190000	SCCB TTb 6/2	B.136
2710190000	SCCB TTb 6/2	B.137
2710190000	SCCB TTb 6/2	B.138
2710190000	SCCB TTb 6/2	B.139
2710190000	SCCB TTb 6/2	B.142
2710190000	SCCB TTb 6/2	B.143
2710190000	SCCB TTb 6/2	B.144
2710200000	SCCB TTb 6/3	B.134
2710200000	SCCB TTb 6/3	B.135
2710200000	SCCB TTb 6/3	B.136
2710200000	SCCB TTb 6/3	B.137
2710200000	SCCB TTb 6/3	B.138
2710200000	SCCB TTb 6/3	B.139
2710210000	SCCB TTb 6/4	B.134
2710210000	SCCB TTb 6/4	B.135
2710210000	SCCB TTb 6/4	B.136
2710210000	SCCB TTb 6/4	B.137
2710210000	SCCB TTb 6/4	B.138
2710210000	SCCB TTb 6/4	B.139
2710210000	SCCB TTb 6/4	B.142
2710210000	SCCB TTb 6/4	B.143
2710210000	SCCB TTb 6/4	B.144
2710220000	SL TTb 6	B.135
2710220000	SL TTb 6	B.136
2710220000	SL TTb 6	B.137
2710220000	SL TTb 6	B.138
2710220000	SL TTb 6	B.139
2710230000	LL TTb 6/1	B.135
2710230000	LL TTb 6/1	B.136
2710230000	LL TTb 6/1	B.137
2710230000	LL TTb 6/1	B.138
2710230000	LL TTb 6/1	B.139
2710230000	LL TTb 6/1	B.142
2710230000	LL TTb 6/1	B.143
2710230000	LL TTb 6/1	B.144
2710300000	LL TTb 6/2	B.134
2710300000	LL TTb 6/2	B.135
2710300000	LL TTb 6/2	B.136
2710300000	LL TTb 6/2	B.137
2710300000	LL TTb 6/2	B.138
2710300000	LL TTb 6/2	B.139
2710300000	LL TTb 6/2	B.142
2710300000	LL TTb 6/2	B.143
2710300000	LL TTb 6/2	B.144
2710300000	LL TTb 6/2	B.145
2710370000	LL TTb 6/2 CM	B.134
2710370000	LL TTb 6/2 CM	B.135
2710370000	LL TTb 6/2 CM	B.136
2710370000	LL TTb 6/2 CM	B.137
2710370000	LL TTb 6/2 CM	B.138
2710370000	LL TTb 6/2 CM	B.139
2710440000	LL TTb 6/3	B.134
2710440000	LL TTb 6/3	B.136
2710440000	LL TTb 6/3	B.138
2710440000	LL TTb 6/3	B.142
2710440000	LL TTb 6/3	B.144
2710450000	LL TTb 6/4	B.134
2710450000	LL TTb 6/4	B.136
2710450000	LL TTb 6/4	B.138
2710450000	LL TTb 6/4	B.142
2710450000	LL TTb 6/4	B.144
2710460000	LL TTb 6/6	B.134
2710460000	LL TTb 6/6	B.136
2710460000	LL TTb 6/6	B.138
2710460000	LL TTb 6/6	B.142
2710460000	LL TTb 6/6	B.144
2710470000	TS TTb 6 OR	B.134
2710470000	TS TTb 6 OR	B.135
2710470000	TS TTb 6 OR	B.136
2710470000	TS TTb 6 OR	B.137
2710470000	TS TTb 6 OR	B.138
2710470000	TS TTb 6 OR	B.139
2710470000	TS TTb 6 OR	B.142
2710470000	TS TTb 6 OR	B.143
2710470000	TS TTb 6 OR	B.144
2710480000	TS TTb 6 BL	B.135
2710480000	TS TTb 6 BL	B.136</

Order No.	Type	Page
-----------	------	------

273000000

2730310000	WPD 111 1X95/4X35 RD	B.84
2730320000	WPD 111 1X95/4X35 BK	B.84
2730350000	WPD 113 1X185+1X150/8X35 RD	B.86
2730360000	WPD 113 1X185+1X150/8X35 BK	B.86
2731220000	WPD 201 4X25/4X16 GY	B.60
2731230000	WPD 201 4X25/4X16 BL	B.60
2731240000	WPD 201 4X25/4X16 GN	B.60
2731250000	WPD 201 4X25/4X16 BN	B.60
2731260000	WPD 201 4X25/4X16 BK	B.60
2731380000	TS 35X7.5/1.0 2M/CU/BK	C.18
2732600000	WDK 2.5V ZDV OR	A.263
2733950000	ZQV 6N/6	A.111
2733950000	ZQV 6N/6	B.134
2733950000	ZQV 6N/6	B.135
2733950000	ZQV 6N/6	B.136
2733950000	ZQV 6N/6	B.137
2733950000	ZQV 6N/6	B.138
2733950000	ZQV 6N/6	B.139
2733950000	ZQV 6N/6	B.142
2733950000	ZQV 6N/6	B.143
2733950000	ZQV 6N/6	B.145
2733960000	ZQV 6N/7	A.111
2733960000	ZQV 6N/7	B.134
2733960000	ZQV 6N/7	B.135
2733960000	ZQV 6N/7	B.136
2733960000	ZQV 6N/7	B.137
2733960000	ZQV 6N/7	B.138
2733960000	ZQV 6N/7	B.139
2733960000	ZQV 6N/7	B.142
2733960000	ZQV 6N/7	B.143
2733960000	ZQV 6N/7	B.145
2733970000	ZQV 6N/10	A.111
2733970000	ZQV 6N/10	B.134
2733970000	ZQV 6N/10	B.135
2733970000	ZQV 6N/10	B.136
2733970000	ZQV 6N/10	B.137
2733970000	ZQV 6N/10	B.138
2733970000	ZQV 6N/10	B.139
2733970000	ZQV 6N/10	B.142
2733970000	ZQV 6N/10	B.143
2733970000	ZQV 6N/10	B.145
2734150000	A2C 4 FE WT	B.251
2734150000	A2C 4 FE WT	B.253
2734160000	A2C 6 FE WT	B.251
2734160000	A2C 6 FE WT	B.253
2734170000	A2C 10 FE WT	B.251
2734170000	A2C 10 FE WT	B.253
2735510000	A3T 2.5 VL DL	A.102
2735950000	A2C 35 PE DL	A.102
2736830000	A2T 2.5 3C N-FT	A.37
2738140000	ZDK 2.5/D-9	A.223
2738690000	RAILASSEMBLER	A.99
2739600000	WDK 2.5V ZDV	A.263
2739610000	WDK 2.5V ZDV BL	A.263

274000000

2742040000	AMC 2.5 DL	A.102
2742050000	AMC 2.5 800V DL	A.102
2742060000	A2C 35 DL	A.101
2742070000	A2C 35 FE DL	A.101
2742080000	AAP12 10/4X2.5 PE-L DL	A.102
2742090000	A2C 50/70 DL	A.101
2742100000	A2C 50/70 FE DL	A.101
2742110000	A2C 50/70 PE DL	A.102
2742120000	A2C 95/120 DL	A.101
2742130000	A2C 95/120 FE DL	A.101
2742140000	A2C 95/120 PE DL	A.102
2743180000	ST 4000/S M8 F	A.382
2743190000	ST 4000/S M10 F	A.382
2743200000	ST 4000/L M12 F	A.383
2744110000	A2T 2.5 DT/DT	A.70
2744120000	A2T 2.5 DT/DT BL	A.70
2744130000	A2T 2.5 DT/FT	A.70
2744140000	A2T 2.5 DT/FT BL	A.70
2744150000	AEP DT 2.5 2T	A.70
2744160000	AEP DT 2.5 2T BL	A.70
2749140000	SDIL 0.6X3.5X100	A.6
2749140000	SDIL 0.6X3.5X100	A.7
2749140000	SDIL 0.6X3.5X100	A.8
2749140000	SDIL 0.6X3.5X100	A.9
2749140000	SDIL 0.6X3.5X100	A.10
2749140000	SDIL 0.6X3.5X100	A.11
2749140000	SDIL 0.6X3.5X100	A.12
2749140000	SDIL 0.6X3.5X100	A.17
2749140000	SDIL 0.6X3.5X100	A.18
2749140000	SDIL 0.6X3.5X100	A.19
2749140000	SDIL 0.6X3.5X100	A.20
2749140000	SDIL 0.6X3.5X100	A.21
2749140000	SDIL 0.6X3.5X100	A.34
2749140000	SDIL 0.6X3.5X100	A.35
2749140000	SDIL 0.6X3.5X100	A.36
2749140000	SDIL 0.6X3.5X100	A.37
2749140000	SDIL 0.6X3.5X100	A.38
2749140000	SDIL 0.6X3.5X100	A.39
2749140000	SDIL 0.6X3.5X100	A.42
2749140000	SDIL 0.6X3.5X100	A.43

Order No.	Type	Page
-----------	------	------

2749140000	SDIL 0.6X3.5X100	A.44
2749140000	SDIL 0.6X3.5X100	A.47
2749140000	SDIL 0.6X3.5X100	A.48
2749140000	SDIL 0.6X3.5X100	A.49
2749140000	SDIL 0.6X3.5X100	A.50
2749140000	SDIL 0.6X3.5X100	A.51
2749140000	SDIL 0.6X3.5X100	A.57
2749140000	SDIL 0.6X3.5X100	A.58
2749140000	SDIL 0.6X3.5X100	A.59
2749140000	SDIL 0.6X3.5X100	A.60
2749140000	SDIL 0.6X3.5X100	A.61
2749140000	SDIL 0.6X3.5X100	A.62
2749140000	SDIL 0.6X3.5X100	A.63
2749140000	SDIL 0.6X3.5X100	A.64
2749140000	SDIL 0.6X3.5X100	A.66
2749140000	SDIL 0.6X3.5X100	A.67
2749140000	SDIL 0.6X3.5X100	A.68
2749140000	SDIL 0.6X3.5X100	A.69
2749140000	SDIL 0.6X3.5X100	A.70
2749140000	SDIL 0.6X3.5X100	A.71
2749140000	SDIL 0.6X3.5X100	A.76
2749140000	SDIL 0.6X3.5X100	A.77
2749140000	SDIL 0.6X3.5X100	A.78
2749140000	SDIL 0.6X3.5X100	A.79
2749140000	SDIL 0.6X3.5X100	A.80
2749140000	SDIL 0.6X3.5X100	A.81
2749140000	SDIL 0.6X3.5X100	A.82
2749140000	SDIL 0.6X3.5X100	A.83
2749140000	SDIL 0.6X3.5X100	A.88
2749140000	SDIL 0.6X3.5X100	A.92
2749140000	SDIL 0.6X3.5X100	A.93
2749140000	SDIL 0.6X3.5X100	A.94
2749140000	SDIL 0.6X3.5X100	A.95
2749140000	SDIL 0.6X3.5X100	A.103
2749140000	SDIL 0.6X3.5X100	B.94
2749140000	SDIL 0.6X3.5X100	B.109
2749140000	SDIL 0.6X3.5X100	B.111
2749140000	SDIL 0.6X3.5X100	B.114
2749140000	SDIL 0.6X3.5X100	B.115
2749140000	SDIL 0.6X3.5X100	B.116
2749140000	SDIL 0.6X3.5X100	B.119
2749140000	SDIL 0.6X3.5X100	B.252
2749140000	SDIL 0.6X3.5X100	B.253
2749140000	SDIL 0.6X3.5X100	B.256
2749140000	SDIL 0.6X3.5X100	B.257
2749140000	SDIL 0.6X3.5X100	B.258
2749140000	SDIL 0.6X3.5X100	B.278
2749140000	SDIL 0.6X3.5X100	B.280
2749140000	SDIL 0.6X3.5X100	B.282
2749140000	SDIL 0.6X3.5X100	B.284
2749140000	SDIL 0.6X3.5X100	B.285
2749140000	SDIL 0.6X3.5X100	B.286
2749140000	SDIL 0.6X3.5X100	B.287
2749140000	SDIL 0.6X3.5X100	B.288
2749140000	SDIL 0.6X3.5X100	B.289
2749140000	SDIL 0.6X3.5X100	B.289
2749140000	SDIL 0.6X3.5X100	B.290
2749140000	SDIL 0.6X3.5X100	B.291
2749140000	SDIL 0.6X3.5X100	B.292
2749140000	SDIL 0.6X3.5X100	B.293
2749160000	SDIL 1.0X5.5X125	A.22
2749160000	SDIL 1.0X5.5X125	A.23
2749160000	SDIL 1.0X5.5X125	A.24
2749160000	SDIL 1.0X5.5X125	A.25
2749160000	SDIL 1.0X5.5X125	A.26
2749160000	SDIL 1.0X5.5X125	A.27
2749160000	SDIL 1.0X5.5X125	A.52
2749160000	SDIL 1.0X5.5X125	A.53
2749160000	SDIL 1.0X5.5X125	A.54
2749160000	SDIL 1.0X5.5X125	B.102
2749160000	SDIL 1.0X5.5X125	B.103
2749160000	SDIL 1.0X5.5X125	B.104
2749160000	SDIL 1.0X5.5X125	B.105
2749160000	SDIL 1.0X5.5X125	B.108
2749160000	SDIL 1.0X5.5X125	B.109
2749160000	SDIL 1.0X5.5X125	B.110
2749160000	SDIL 1.0X5.5X125	B.118
2749160000	SDIL 1.0X5.5X125	B.258
2749160000	SDIL 1.0X5.5X125	B.278
2749160000	SDIL 1.0X5.5X125	B.280
2749160000	SDIL 1.0X5.5X125	B.282
2749160000	SDIL 1.0X5.5X125	B.285
2749160000	SDIL 1.0X5.5X125	B.287
2749160000	SDIL 1.0X5.5X125	B.288
2749160000	SDIL 1.0X5.5X125	B.289
2749160000	SDIL 1.0X5.5X125	B.290
2749160000	SDIL 1.0X5.5X125	B.291
2749160000	SDIL 1.0X5.5X125	B.292
2749160000	SDIL 1.0X5.5X125	B.293
2749260000	SDS 0.4X2.0X60	A.16
2749260000	SDS 0.4X2.0X60	A.32
2749260000	SDS 0.4X2.0X60	A.33
2749260000	SDS 0.4X2.0X60	A.40
2749260000	SDS 0.4X2.0X60	A.41
2749260000	SDS 0.4X2.0X60	A.46
2749260000	SDS 0.4X2.0X60	A.47
2749260000	SDS 0.4X2.0X60	A.59
2749260000	SDS 0.4X2.0X60	A.72
2749260000	SDS 0.4X2.0X60	A.73
2749260000	SDS 0.4X2.0X60	A.74
2749260000	SDS 0.4X2.0X60	A.75
2749260000	SDS 0.4X2.0X60	A.128
2749260000	SDS 0.4X2.0X60	A.129
2749260000	SDS 0.4X2.0X60	A.144

Order No.	Type	Page
-----------	------	------

2749260000	SDS 0.4X2.0X60	A.145
2749260000	SDS 0.4X2.0X60	A.161
2749260000	SDS 0.4X2.0X60	A.162
2749260000	SDS 0.4X2.0X60	A.174
2749260000	SDS 0.4X2.0X60	B.184
2749260000	SDS 0.4X2.0X60	B.185
2749260000	SDS 0.4X2.0X60	B.297
2749330000	SDS 0.6X3.5X100	A.175
2749340000	SDS 0.6X3.5X100	A.153
2749340000	SDS 0.6X3.5X100	A.182
2749340000	SDS 0.6X3.5X100	A.202
2749340000	SDS 0.6X3.5X100	A.224
2749340000	SDS 0.6X3.5X100	A.272
2749340000	SDS 0.6X3.5X100	A.273
2749340000	SDS 0.6X3.5X100	A.274
2749340000	SDS 0.6X3.5X100	A.275
2749340000	SDS 0.6X3.5X100	A.276
2749340000	SDS 0.6X3.5X100	A.277
2749340000	SDS 0.6X3.5X100	A.282
2749340000	SDS 0.6X3.5X100	A.283
2749340000	SDS 0.6X3.5X100	A.284
2749340000	SDS 0.6X3.5X100	A.285
2749340000	SDS 0.6X3.5X100	A.286
2749340000	SDS 0.6X3.5X100	A.287
2749340000	SDS 0.6X3.5X100	A.288
2749340000	SDS 0.6X3.5X100	A.299
2749340000	SDS 0.6X3.5X100	A.308
2749340000	SDS 0.6X3.5X100	A.309
2749340000	SDS 0.6X3.5X100	A.310
2749340000	SDS 0.6X3.5X100	A.311
2749340000	SDS 0.6X3.5X100	A.314
2749340000	SDS 0.6X3.5X100	A.315
2749340000	SDS 0.6X3.5X100	A.318
2749340000	SDS 0.6X3.5X100	A.319
2749340000	SDS 0.6X3.5X100	A.320
2749340000	SDS 0.6X3.5X100	A.321
2749340000	SDS 0.6X3.5X100	A.322
2749340000	SDS 0.6X3.5X100	A.331
2749340000	SDS 0.6X3.5X100	A.332
2749340000	SDS 0.6X3.5X100	A.333
2749340000	SDS 0.6X3.5X100	A.334
2749340000	SDS 0.6X3.5X100	A.335
2749340000	SDS 0.6X3.5X100	B.190
2749340000	SDS 0.6X3.5X100	B.191
2749340000	SDS 0.6X3.5X100	B.192
2749340000	SDS 0.6X3.5X100	B.193
2749340000	SDS 0.6X3.5X100	B.203
2749340000	SDS 0.6X3.5X100	B.204
2749340000	SDS 0.6X3.5X100	B.205
2749340000	SDS 0.6X3.5X100	B.206
2749340000	SDS 0.6X3.5X100	B.207
2749340000	SDS 0.6X3.5X100	B.208
2749340000	SDS 0.6X3.5X100	B.209
2749340000	SDS 0.6X3.5X100	B.210
2749340000	SDS 0.6X3.5X100	B.211
2749340000	SDS 0.6X3.5X100	B.212
2749340000	SDS 0.6X3.5X100	B.213
2749340000	SDS 0.6X3.5X1	

Order No.	Type	Page
2749610000	SDIS SLIM 0.6X3.5X100	A.197
2749610000	SDIS SLIM 0.6X3.5X100	A.198
2749610000	SDIS SLIM 0.6X3.5X100	A.199
2749610000	SDIS SLIM 0.6X3.5X100	A.200
2749610000	SDIS SLIM 0.6X3.5X100	A.201
2749610000	SDIS SLIM 0.6X3.5X100	A.202
2749610000	SDIS SLIM 0.6X3.5X100	A.203
2749610000	SDIS SLIM 0.6X3.5X100	A.204
2749610000	SDIS SLIM 0.6X3.5X100	A.205
2749610000	SDIS SLIM 0.6X3.5X100	A.208
2749610000	SDIS SLIM 0.6X3.5X100	A.209
2749610000	SDIS SLIM 0.6X3.5X100	A.210
2749610000	SDIS SLIM 0.6X3.5X100	A.216
2749610000	SDIS SLIM 0.6X3.5X100	A.217
2749610000	SDIS SLIM 0.6X3.5X100	A.218
2749610000	SDIS SLIM 0.6X3.5X100	A.219
2749610000	SDIS SLIM 0.6X3.5X100	A.220
2749610000	SDIS SLIM 0.6X3.5X100	A.221
2749610000	SDIS SLIM 0.6X3.5X100	A.222
2749610000	SDIS SLIM 0.6X3.5X100	A.223
2749610000	SDIS SLIM 0.6X3.5X100	A.316
2749610000	SDIS SLIM 0.6X3.5X100	B.95
2749610000	SDIS SLIM 0.6X3.5X100	B.188
2749610000	SDIS SLIM 0.6X3.5X100	B.189
2749610000	SDIS SLIM 0.6X3.5X100	B.216
2749610000	SDIS SLIM 0.6X3.5X100	B.217
2749610000	SDIS SLIM 0.6X3.5X100	B.218
2749610000	SDIS SLIM 0.6X3.5X100	B.219
2749610000	SDIS SLIM 0.6X3.5X100	B.254
2749620000	SDIS SLIM 0.8X4.0X100	A.129
2749620000	SDIS SLIM 0.8X4.0X100	A.141
2749620000	SDIS SLIM 0.8X4.0X100	A.171
2749620000	SDIS SLIM 0.8X4.0X100	A.186
2749620000	SDIS SLIM 0.8X4.0X100	A.187
2749620000	SDIS SLIM 0.8X4.0X100	A.188
2749620000	SDIS SLIM 0.8X4.0X100	A.189
2749620000	SDIS SLIM 0.8X4.0X100	A.190
2749620000	SDIS SLIM 0.8X4.0X100	A.199
2749780000	SDIS 0.4X2.0X60	A.56
2749780000	SDIS 0.4X2.0X60	B.103
2749780000	SDIS 0.4X2.0X60	B.105
2749810000	SDIS 0.6X3.5X100	A.193
2749810000	SDIS 0.6X3.5X100	A.271
2749810000	SDIS 0.6X3.5X100	B.52
2749810000	SDIS 0.6X3.5X100	B.97
2749810000	SDIS 0.6X3.5X100	B.226
2749810000	SDIS 0.6X3.5X100	B.268
2749810000	SDIS 0.6X3.5X100	B.302
2749810000	SDIS 0.6X3.5X100	B.303
2749850000	SDIS 1.0X5.5X125	B.52

2750000000

2751080000	SEP 2C 2.5	A.6
2751080000	SEP 2C 2.5	A.10
2751090000	SEP 3C 2.5	A.6
2751090000	SEP 3C 2.5	A.10
2751100000	SEP 4C 2.5	A.7
2751100000	SEP 4C 2.5	A.11
2753940000	S2C 2.5 BL	A.6
2753950000	S3C 2.5 BL	A.6
2753960000	S4C 2.5 BL	A.7
2755890000	A2C 35 DL BL	A.101
2755900000	A2C 50/70 DL BL	A.101
2755910000	A2C 95/120 DL BL	A.101
2756940000	EBB 25-50/16 AM	B.250
2757430000	A3T 2.5 FT-FT-PE DL	A.102

2760000000

2762280000	ATTB 6 PG CT	B.142
2762280000	ATTB 6 PG CT	B.143
2762290000	ATTB 6 PG VT	B.142
2762290000	ATTB 6 PG VT	B.143
2762310000	AEP TTB 6 PG	B.142
2762310000	AEP TTB 6 PG	B.143
2762320000	APG 6/1	B.142
2762320000	APG 6/1	B.143
2762320000	APG 6/1	B.146
2762330000	APG 6/2 MBB	B.142
2762330000	APG 6/2 MBB	B.143
2762330000	APG 6/2 MBB	B.146
2762340000	APG 6/3 MBB	B.142
2762340000	APG 6/3 MBB	B.143
2762340000	APG 6/3 MBB	B.146
2762380000	MCV APG 6	B.146
2762390000	APGSR 6	B.142
2762390000	APGSR 6	B.147
2762400000	APGLE 6	B.142
2762400000	APGLE 6	B.147
2762410000	APGPC 6	B.142
2762410000	APGPC 6	B.146
2762660000	JB 25-50 TH	B.250

2770000000

2770670000	DEK 5/8 PLUS MC WS LRP	B.143
2771890000	A3T 2.5 DL	A.102

Order No.	Type	Page
2788890000	Z0V 6N/6 BL	A.111
2786900000	Z0V 6N/7 BL	A.111
2786910000	Z0V 6N/10 BL	A.111

2790000000

2792420000	ATTB 6 DL	A.102
2792430000	ATTB 6 PE DL	A.102
2792440000	WTTB 6 DL	A.102
2792450000	WTTB 6 PE DL	A.102
2792460000	HTTB 6 DL	A.102
2792470000	HTTB 6 PE DL	A.102
2798140000	AWPD 35 4X10 DL	A.102
2798150000	AWPD 35 4X6/6X2.5 DL	A.102
2799150000	A2C 2.5 DL OR	A.101
2799160000	A4C 2.5 DL OR	A.101
2799170000	A2C 4 DL OR	A.101
2799180000	A4C 4 DL OR	A.101
2799190000	A2C 6 DL OR	A.101

2810000000

2810820000	Z0V 6N/20	A.111
2810830000	Z0V 4N/10 BK	A.113
2810830000	Z0V 4N/10 BK	A.345
2810840000	Z0V 4N/2 BK	A.113
2810840000	Z0V 4N/2 BK	A.345
2810850000	Z0V 4N/20 BL	A.110
2810850000	Z0V 4N/20 BL	A.344
2810860000	Z0V 4N/20 RD	A.110
2810860000	Z0V 4N/20 RD	A.344
2810870000	Z0V 4N/20 BK	A.113
2810870000	Z0V 4N/20 BK	A.345
2810880000	Z0V 4N/3 BK	A.113
2810880000	Z0V 4N/3 BK	A.345
2810890000	Z0V 4N/4 BK	A.113
2810890000	Z0V 4N/4 BK	A.345
2810900000	Z0V 4N/5 BK	A.113
2810900000	Z0V 4N/5 BK	A.345
2810910000	Z0V 4N/6 BK	A.113
2810910000	Z0V 4N/6 BK	A.345
2810920000	Z0V 4N/7 BK	A.113
2810920000	Z0V 4N/7 BK	A.345
2810930000	Z0V 4N/8 BK	A.113
2810930000	Z0V 4N/8 BK	A.345
2814490000	WPD 100 2X25/6X10 BK	B.54
2814500000	WPD 100 2X25/6X10 BN	B.54
2814510000	WPD 110 1X70+1X35/6X16 BK	B.56
2814520000	WPD 110 1X70+1X35/6X16 BN	B.56
2815620000	A2T 2.5 VL DL BL	A.101
2816930000	A3T 1.5	A.40
2816940000	A3T 1.5 BL	A.40
2816950000	AEP 3T 1.5	A.40
2816950000	AEP 3T 1.5	A.41
2816950000	AEP 3T 1.5	A.59
2816960000	A2T 4 FS-FT BK	A.64
2816970000	A2T 4 FS-FT 10-36V BK	A.64
2816980000	A2T 4 FS-FT 30-70V BK	A.64
2816990000	A2T 4 FS-FT 60-150V BK	A.64
2817000000	A2T 4 FS-FT 100-250V BK	A.64
2817010000	A2T 4 FS-FT-PE BK	A.64
2817020000	A2T 4 FS-FT-PE 10-36V BK	A.64
2817030000	A2T 4 FS-FT-PE 30-70V BK	A.64
2817040000	A2T 4 FS-FT-PE 60-150V BK	A.64
2817050000	A2T 4 FS-FT-PE 100-250V BK	A.64
2817060000	AEP 2T 4 FS	A.63
2817060000	AEP 2T 4 FS	A.64
2817060000	AEP 2T 4 FS	A.71
2817770000	AEB 35 SCL/1 V0 TGY DL	A.102
2817980000	A3T 1.5 VL	A.40
2817990000	A3T 1.5 FT-FT-PE	A.41
2818000000	A3T 1.5 PE	A.59

2820000000

2820630000	A2T 2.5 EM1 D3/1	A.93
2820640000	A2T 2.5 EM1 D3/2	A.93
2820650000	ASP 2T 2.5	A.95
2829060000	APG 6/4	B.143

2830000000

2831500000	A2T 4 FS-FT	A.63
2831510000	A2T 4 FS-FT-PE	A.63
2831520000	A2T 4 DT-FT	A.63
2831520000	A2T 4 DT-FT	A.64
2831520000	A2T 4 DT-FT	A.71
2831530000	A2T 4 DT-FT-PE	A.63
2831530000	A2T 4 DT-FT-PE	A.64
2831530000	A2T 4 DT-FT-PE	A.71
2831540000	A2T 4 DT-FT-PE W/O DTLV	A.71
2831550000	A2T 4 DT-FT-PE W/O DTLV	A.71
2831560000	Z0V 2.5N/2 WT	A.113
2831560000	Z0V 2.5N/2 WT	A.345
2831570000	Z0V 2.5N/3 WT	A.113
2831570000	Z0V 2.5N/3 WT	A.345
2831580000	Z0V 2.5N/4 WT	A.113

Order No.	Type	Page
2831580000	Z0V 2.5N/4 WT	A.345
2831590000	Z0V 2.5N/5 WT	A.113
2831590000	Z0V 2.5N/5 WT	A.345
2831600000	Z0V 2.5N/6 WT	A.113
2831600000	Z0V 2.5N/6 WT	A.345
2831610000	Z0V 2.5N/7 WT	A.113
2831610000	Z0V 2.5N/7 WT	A.345
2831620000	Z0V 2.5N/8 WT	A.113
2831620000	Z0V 2.5N/8 WT	A.345
2831630000	Z0V 2.5N/9 WT	A.113
2831630000	Z0V 2.5N/9 WT	A.345
2831640000	Z0V 2.5N/10 WT	A.113
2831640000	Z0V 2.5N/10 WT	A.345
2831650000	Z0V 2.5N/20 WT	A.113
2831650000	Z0V 2.5N/20 WT	A.345
2831660000	Z0V 2.5N/50 WT	A.113
2831660000	Z0V 2.5N/50 WT	A.345
2831670000	Z0V 2.5N/2 BK	A.113
2831670000	Z0V 2.5N/2 BK	A.345
2831680000	Z0V 2.5N/3 BK	A.113
2831680000	Z0V 2.5N/3 BK	A.345
2831690000	Z0V 2.5N/4 BK	A.113
2831690000	Z0V 2.5N/4 BK	A.345
2831700000	Z0V 2.5N/5 BK	A.113
2831700000	Z0V 2.5N/5 BK	A.345
2831710000	Z0V 2.5N/6 BK	A.113
2831710000	Z0V 2.5N/6 BK	A.345
2831720000	Z0V 2.5N/7 BK	A.113
2831720000	Z0V 2.5N/7 BK	A.345
2831730000	Z0V 2.5N/8 BK	A.113
2831730000	Z0V 2.5N/8 BK	A.345
2831740000	Z0V 2.5N/9 BK	A.113
2831740000	Z0V 2.5N/9 BK	A.345
2831750000	Z0V 2.5N/10 BK	A.113
2831750000	Z0V 2.5N/10 BK	A.345
2831760000	Z0V 2.5N/20 BK	A.113
2831760000	Z0V 2.5N/20 BK	A.345
2831770000	Z0V 2.5N/50 BK	A.113
2831770000	Z0V 2.5N/50 BK	A.345
2831780000	Z0V 4N/9 BK	A.113
2831780000	Z0V 4N/9 BK	A.345
2831790000	Z0V 4N/10 WT	A.113
2831790000	Z0V 4N/10 WT	A.345
2831800000	Z0V 4N/2 WT	A.113
2831800000	Z0V 4N/2 WT	A.345
2831810000	Z0V 4N/3 WT	A.113
2831810000	Z0V 4N/3 WT	A.345
2831820000	Z0V 4N/4 WT	A.113
2831820000	Z0V 4N/4 WT	A.345
2831830000	Z0V 4N/5 WT	A.113
2831830000	Z0V 4N/5 WT	A.345
2831840000	Z0V 4N/6 WT	A.113
2831840000	Z0V 4N/6 WT	A.345
2831850000	Z0V 4N/7 WT	A.113
2831850000	Z0V 4N/7 WT	A.345
2831860000	Z0V 4N/8 WT	A.113
2831860000	Z0V 4N/8 WT	A.345
2831870000	Z0V 4N/9 WT	A.113
2831870000	Z0V 4N/9 WT	A.345
2831890000	Z0V 4N/41 BK	A.113
2831890000	Z0V 4N/41 BK	A.345

2840000000

2842000000	AL2C 2.5	A.17
2842000000	AL2C 2.5	A.119
2842100000	AL2C 2.5 BL	A.17
2842100000	AL2C 2.5 BL	A.119
2842200000	AL2C 2.5 DBL	A.119
2842200000	AL2C 2.5 DBL	A.119
2842230000	AL2C 2.5 RD	A.119
2842240000	AL2C 2.5 RD	A.119
2842250000	AL2C 2.5 GN	A.119
2842260000	AL2C 2.5 VT	A.119
2842270000	AL2C 2.5 BK	A.119
2842280000	AL2C 2.5 WT	A.119
2842290000	AL2C 2.5 VL	A.119
2842300000	AL2C 2.5 LTGY	A.119
2842310000	AL2C 2.5 BR	A.119
2842320000	AL2C 2.5 FE	B.256
2842330000	AL3C 2.5	A.18
2842330000	AL3C 2.5	A.119
2842340000	AL3C 2.5 BL	A.18
2842340000	AL3C 2.5 BL	A.119
2842350000	AL3C 2.5 DBL	A.119
2842360000	AL3C 2.5 RD</	

Order No.	Type	Page
2871900000	AL2C 4 OR	A.119
2871910000	AL2C 4 GN	A.119
2871920000	AL2C 4 VT	A.119
2871930000	AL2C 4 BK	A.119
2871940000	AL2C 4 WT	A.119
2871950000	AL2C 4 YL	A.119
2871960000	AL2C 4 LTGY	A.119
2871970000	AL2C 4 BR	A.119
2871980000	AL2C 4 FE	B.257
2871990000	AL3C 4 BL	A.21
2871990000	AL3C 4 BL	A.119
2872000000	AL3C 4 DBL	A.119
2872010000	AL3C 4 OR	A.119
2872020000	AL3C 4 RD	A.119
2872030000	AL3C 4 VN	A.119
2872040000	AL3C 4 VT	A.119
2872050000	AL3C 4 BK	A.119
2872060000	AL3C 4 WT	A.119
2872070000	AL3C 4 YL	A.119
2872080000	AL3C 4 LTGY	A.119
2872090000	AL3C 4 BR	A.119
2872100000	AL3C 4 FE	B.257
2872110000	AL4C 4 BL	A.21
2872110000	AL4C 4 BL	A.119
2872120000	AL4C 4 DBL	A.119
2872130000	AL4C 4 RD	A.119
2872140000	AL4C 4 OR	A.119
2872150000	AL4C 4 GN	A.119
2872160000	AL4C 4 VT	A.119
2872170000	AL4C 4 BK	A.119
2872180000	AL4C 4 WT	A.119
2872190000	AL4C 4 YL	A.119
2872200000	AL4C 4 LTGY	A.119
2872210000	AL4C 4 BR	A.119
2872220000	AL4C 4 FE	B.258
2874510000	WPD 330CC 3X50/3X50 GY	B.39
2874520000	WPD 330CC 3X50/3X50 BK	B.39
2874530000	WPD 330CC 3X50/3X50 BL	B.39
2874540000	WPD 330CC 3X50/3X50 BN	B.39
2874550000	WPD 330CC 3X50/3X50 GN	B.39
2874560000	WPD 331CC 3X95/3X95 GY	B.43
2874570000	WPD 331CC 3X95/3X95 BK	B.43
2874580000	WPD 331CC 3X95/3X95 BL	B.43
2874590000	WPD 331CC 3X95/3X95 BN	B.43
2874600000	WPD 331CC 3X95/3X95 GN	B.43
2874790000	SEP 2C 4	A.7
2874800000	SEP 2C 4	A.11
2874810000	SEP 2C 4	A.7
2874820000	SEP 2C 4	A.11
2874830000	SEP 2C 4	A.7
2874840000	SEP 2C 4	A.11
2874850000	SEP 2C 4	A.7
2874860000	SEP 2C 4	A.11
2874870000	SEP 2C 4	A.7
2874880000	SEP 2C 4	A.11
2874890000	SEP 2C 4	A.7
2874900000	SEP 2C 4	A.11
2874910000	SEP 2C 4	A.7
2874920000	SEP 2C 4	A.11
2874930000	SEP 2C 4	A.7
2874940000	SEP 2C 4	A.11
2874950000	SEP 2C 4	A.7
2874960000	SEP 2C 4	A.11
2874970000	SEP 2C 4	A.7
2874980000	SEP 2C 4	A.11
2874990000	SEP 2C 4	A.7
2875120000	S2C 2.5 OR	A.6
2875130000	S3C 2.5 OR	A.6
2875140000	S4C 2.5 OR	A.7
2876180000	AEP 4C 6	A.23
2876180000	AEP 4C 6	A.53
2876180000	AEP 4C 6	B.258
2876190000	AEP 4C 6 BL	A.23
2876190000	AEP 4C 6 BL	B.258
2876640000	A2C 2.5 VT	A.118

2880000000

2881450000	A4C 6	A.23
2881460000	A4C 6 BL	A.23
2881480000	A4C 6 FE	B.258
2881490000	A4C 6 PE	A.53
2881500000	A4C 6 DL	A.101
2881510000	A4C 6 DL BL	A.101
2881520000	A4C 6 DL OR	A.101
2881530000	A4C 6 DL FE	A.101
2881540000	A4C 6 PE DL	A.102
2881640000	APP ITB 2.5 BB BL V	B.284
2881640000	APP ITB 2.5 BB BL V	B.285
2881640000	APP ITB 2.5 BB BL V	B.286
2881640000	APP ITB 2.5 BB BL V	B.287
2881650000	APP ITB 4 BB BL V	B.288
2881650000	APP ITB 4 BB BL V	B.289
2882890000	APG 6/3	B.143
2882750000	APG 6/2	B.143
2883800000	ZDV 4N/20	A.110

Order No.	Type	Page
2883800000	ZDV 4N/20	A.344
2883810000	ZDV 4N/41	A.110
2883810000	ZDV 4N/41	A.344
2883820000	ZDV 4N/41 BL	A.110
2883820000	ZDV 4N/41 BL	A.344
2883840000	ZDV 4N/41 RD	A.110
2883840000	ZDV 4N/41 RD	A.344

2890000000

2892650000	W2C 4 FT	B.203
2892660000	W2C 4 FT BL	B.203
2892670000	W2C 4 FT BK	B.203
2892680000	W2C 4 FT STB	B.203
2892690000	W2C 4 FT PE	B.204
2892700000	W2C 4 FT-PE STB	B.204
2892740000	W2C 4 DT	B.205
2892750000	W2C 4 DT BL	B.205
2892760000	W2C 4 DT BK	B.205
2892770000	W2C 4 DT STB	B.205
2892780000	W2C 4 DT W/O DTLV	B.206
2892790000	W2C 4 DT W/O DTLV BL	B.206
2892800000	W2C 4 DT W/O DTLV BK	B.206
2892810000	W2C 4 DT PE	B.207
2892820000	W2C 4 DT-PE STB	B.207
2892900000	W2C 4 FS DB	B.208
2892910000	W2C 4 FS BL	B.208
2892920000	W2C 4 FS BK	B.209
2892930000	W2C 4 FS BK STB	B.209
2892940000	W2C 4 FS 10-36V BK STB	B.209
2892950000	W2C 4 FS 30-70V BK STB	B.209
2892960000	W2C 4 FS 60-150V BK STB	B.209
2892970000	W2C 4 FS 100-250V BK STB	B.209
2892980000	W2C 4 FS 10-36V DB	B.208
2892990000	W2C 4 FS 10-36V BK	B.208
2893000000	W2C 4 FS 10-36V BK	B.209
2893010000	W2C 4 FS 30-70V DB	B.208
2893020000	W2C 4 FS 30-70V BL	B.208
2893030000	W2C 4 FS 30-70V BK	B.209
2893040000	W2C 4 FS 60-150V DB	B.208
2893050000	W2C 4 FS 60-150V BL	B.208
2893070000	W2C 4 FS 60-150V BK	B.209
2893080000	W2C 4 FS 100-250V DB	B.208
2893090000	W2C 4 FS 100-250V BL	B.208
2893100000	W2C 4 FS 100-250V BK	B.209
2893120000	W2C 4 FS-PE BK	B.209
2893130000	W2C 4 FS-PE BK STB	B.210
2893140000	W2C 4 FS-PE 10-36V BK	B.209
2893150000	W2C 4 FS-PE 30-70V BK	B.209
2893160000	W2C 4 FS-PE 60-150V BK	B.209
2893170000	W2C 4 FS-PE 100-250V BK	B.210
2893180000	W2C 4 FS-PE 10-36V BK STB	B.209
2893190000	W2C 4 FS-PE 30-70V BK STB	B.210
2893200000	W2C 4 FS-PE 60-150V BK STB	B.210
2893210000	W2C 4 FS-PE 100-250V BK STB	B.211
2893690000	W2T 4 DT-FT	B.211
2893700000	W2T 4 DT-FT BL	B.211
2893710000	W2T 4 DT-FT BK	B.211
2893720000	W2T 4 DT-FT STB	B.211
2893730000	W2T 4 DT-FT PE	B.212
2893740000	W2T 4 DT-FT STB	B.212
2893850000	W2T 4 FS-FT DB	B.213
2893860000	W2T 4 FS-FT BL	B.213
2893870000	W2T 4 FS-FT BK	B.214
2893880000	W2T 4 FS-FT 10-36V DB	B.213
2893890000	W2T 4 FS-FT 10-36V BL	B.213
2893900000	W2T 4 FS-FT 10-36V BK	B.214
2893910000	W2T 4 FS-FT 30-70V DB	B.214
2893920000	W2T 4 FS-FT 30-70V BL	B.213
2893930000	W2T 4 FS-FT 30-70V BK	B.214
2893940000	W2T 4 FS-FT 60-150V DB	B.213
2893950000	W2T 4 FS-FT 60-150V BL	B.213
2893960000	W2T 4 FS-FT 60-150V BK	B.214
2893970000	W2T 4 FS-FT 100-250V DB	B.213
2893980000	W2T 4 FS-FT 100-250V BL	B.214
2893990000	W2T 4 FS-FT 100-250V BK	B.214
2894000000	W2T 4 FS-FT BK STB	B.214
2894010000	W2T 4 FS-FT 10-36V BK STB	B.214
2894020000	W2T 4 FS-FT 30-70V BK STB	B.214
2894030000	W2T 4 FS-FT 60-150V BK STB	B.214
2894040000	W2T 4 FS-FT 100-250V BK STB	B.214
2894050000	W2T 4 FS-FT PE BK	B.215
2894060000	W2T 4 FS-FT PE 10-36V BK	B.215
2894070000	W2T 4 FS-FT PE 30-70V BK	B.215
2894080000	W2T 4 FS-FT PE 60-150V BK	B.215
2894090000	W2T 4 FS-FT PE 100-250V BK	B.215
2894100000	W2T 4 FS-FT PE BK STB	B.215
2894110000	W2T 4 FS-FT PE 10-36V BK STB	B.215
2894120000	W2T 4 FS-FT PE 30-70V BK STB	B.215
2894130000	W2T 4 FS-FT PE 60-150V BK STB	B.215
2894140000	W2T 4 FS-FT PE 100-250V BK STB	B.215
2894210000	WEP 2C 4	B.203
2894210000	WEP 2C 4	B.204
2894210000	WEP 2C 4	B.205
2894210000	WEP 2C 4	B.206
2894210000	WEP 2C 4	B.207
2894210000	WEP 2C 4	B.208
2894210000	WEP 2C 4	B.209
2894210000	WEP 2C 4	B.210
2894210000	WEP 2C 4	B.211
2894210000	WEP 2C 4	B.212
2894210000	WEP 2C 4	B.213
2894210000	WEP 2C 4	B.214
2894210000	WEP 2C 4	B.215
2894210000	WEP 2C 4	B.203
2894210000	WEP 2C 4	B.204
2894210000	WEP 2C 4	B.205
2894210000	WEP 2C 4	B.206
2894210000	WEP 2C 4	B.207
2894210000	WEP 2C 4	B.208
2894210000	WEP 2C 4	B.209
2894210000	WEP 2C 4	B.210
2894210000	WEP 2C 4	B.211
2894210000	WEP 2C 4	B.212
2894210000	WEP 2C 4	B.213
2894210000	WEP 2C 4	B.214
2894210000	WEP 2C 4	B.215
2894210000	WEP 2C 4	B.203
2894210000	WEP 2C 4	B.204
2894210000	WEP 2C 4	B.205
2894210000	WEP 2C 4	B.206
2894210000	WEP 2C 4	B.207
2894210000	WEP 2C 4	B.208
2894210000	WEP 2C 4	B.209
2894210000	WEP 2C 4	B.210
2894210000	WEP 2C 4	B.211
2894210000	WEP 2C 4	B.212
2894210000	WEP 2C 4	B.213
2894210000	WEP 2C 4	B.214
2894210000	WEP 2C 4	B.215
2894210000	WEP 2C 4	B.203
2894210000	WEP 2C 4	B.204
2894210000	WEP 2C 4	B.205
2894210000	WEP 2C 4	B.206
2894210000	WEP 2C 4	B.207
2894210000	WEP 2C 4	B.208
2894210000	WEP 2C 4	B.209
2894210000	WEP 2C 4	B.210
2894210000	WEP 2C 4	B.211
2894210000	WEP 2C 4	B.212
2894210000	WEP 2C 4	B.213
2894210000	WEP 2C 4	B.214
2894210000	WEP 2C 4	B.215

Order No.	Type	Page
2894210000	WEP 2C 4	B.211
2894210000	WEP 2C 4	B.212
2894210000	WEP 2C 4	B.213
2894210000	WEP 2C 4	B.214
2894210000	WEP 2C 4	B.215
2894220000	WEP 2C 4 BL	B.203
2894220000	WEP 2C 4 BL	B.204
2894220000	WEP 2C 4 BL	B.205
2894220000	WEP 2C 4 BL	B.206
2894220000	WEP 2C 4 BL	B.207
2894220000	WEP 2C 4 BL	B.208
2894220000	WEP 2C 4 BL	B.209
2894220000	WEP 2C 4 BL	B.210
2894220000	WEP 2C 4 BL	B.211
2894220000	WEP 2C 4 BL	B.212
2894220000	WEP 2C 4 BL	B.213
2894220000	WEP 2C 4 BL	B.214
2894220000	WEP 2C 4 BL	B.215
2894230000	WEP 2C 4 BK	B.203
2894230000	WEP 2C 4 BK	B.204
2894230000	WEP 2C 4 BK	B.205
2894230000	WEP 2C 4 BK	B.206
2894230000	WEP 2C 4 BK	B.207
2894230000	WEP 2C 4 BK	B.208
2894230000	WEP 2C 4 BK	B.209
2894230000	WEP 2C 4 BK	B.210
2894230000	WEP 2C 4 BK	B.211
2894230000	WEP 2C 4 BK	B.212
2894230000	WEP 2C 4 BK	B.213
2894230000	WEP 2C 4 BK	B.214
2894230000	WEP 2C 4 BK	B.215
2894270000	BZT W2C 4	B.203
2894270000	BZT W2C 4	B.204
2894270000	BZT W2C 4	B.205
2894270000	BZT W2C 4	B.206
2894270000	BZT W2C 4	B.207

2900000000

2902380000	S2T 2.5	A.8
2902390000	S2T 2.5 BL	A.8
2902400000	S2T 2.5 OR	A.9
2902410000	S2T 2.5 FT-PE	A.9
2902420000	S2T 2.5 N-FT	A.9

Order No.	Type	Page
7921580000	SIHA 3/G20/LD 35-70V	A.236
7921580000	SIHA 3/G20/LD 35-70V	A.316
7921580000	SIHA 3/G20/LD 35-70V	A.356
7921590000	SIHA 3/G20/LD 35-70V	B.205
7921590000	SIHA 3/G20/LD 35-70V	B.206
7921590000	SIHA 3/G20/LD 35-70V	B.207
7921580000	SIHA 3/G20/LD 35-70V	B.211
7921580000	SIHA 3/G20/LD 35-70V	B.212
7921590000	SIHA 3/G20/LD 60-150V	A.70
7921590000	SIHA 3/G20/LD 60-150V	A.71
7921590000	SIHA 3/G20/LD 60-150V	A.236
7921590000	SIHA 3/G20/LD 60-150V	A.316
7921590000	SIHA 3/G20/LD 60-150V	A.356
7921590000	SIHA 3/G20/LD 60-150V	B.205
7921590000	SIHA 3/G20/LD 60-150V	B.206
7921590000	SIHA 3/G20/LD 60-150V	B.207
7921590000	SIHA 3/G20/LD 60-150V	B.211
7921590000	SIHA 3/G20/LD 60-150V	B.212
7921600000	SIHA 3/G20/LD 140-250V	A.70
7921600000	SIHA 3/G20/LD 140-250V	A.71
7921600000	SIHA 3/G20/LD 140-250V	A.192
7921600000	SIHA 3/G20/LD 140-250V	A.193
7921600000	SIHA 3/G20/LD 140-250V	A.205
7921600000	SIHA 3/G20/LD 140-250V	A.236
7921600000	SIHA 3/G20/LD 140-250V	A.308
7921600000	SIHA 3/G20/LD 140-250V	A.309
7921600000	SIHA 3/G20/LD 140-250V	A.310
7921600000	SIHA 3/G20/LD 140-250V	A.311
7921600000	SIHA 3/G20/LD 140-250V	A.316
7921600000	SIHA 3/G20/LD 140-250V	A.318
7921600000	SIHA 3/G20/LD 140-250V	A.319
7921600000	SIHA 3/G20/LD 140-250V	A.356
7921600000	SIHA 3/G20/LD 140-250V	B.205
7921600000	SIHA 3/G20/LD 140-250V	B.206
7921600000	SIHA 3/G20/LD 140-250V	B.207
7921600000	SIHA 3/G20/LD 140-250V	B.211
7921600000	SIHA 3/G20/LD 140-250V	B.212
7921600000	SIHA 3/G20/LD 140-250V	B.220
7921600000	SIHA 3/G20/LD 140-250V	B.221
7921600000	SIHA 3/G20/LD 140-250V	B.222
7921600000	SIHA 3/G20/LD 140-250V	B.223
7921600000	SIHA 3/G20/LD 140-250V	B.224
7921600000	SIHA 3/G20/LD 140-250V	B.225
7921600000	SIHA 3/G20/LD 140-250V	B.290
7921600000	SIHA 3/G20/LD 140-250V	B.291
7921600000	SIHA 3/G20/LD 140-250V	B.292
7921600000	SIHA 3/G20/LD 140-250V	B.293

8010000000

8010040000	WDK 2.5 LD GR 1R 24VDC	A.335
8014670000	WDK 2.5 2D 1A	A.336

8020000000

8023610000	WDK 2.5 LD/GN 1R 24VDC	A.335
8023630000	WDK 2.5 LD RT 24VDC +-	A.335
8025610000	WDK 2.5 1D	A.332

8160000000

8161820000	WDUL 4	A.331
------------	--------	-------

8630000000

8630740000	ZEW 35/2	A.150
8630740000	ZEW 35/2	A.176
8630740000	ZEW 35/2	B.115
8630740000	ZEW 35/2	C.21

8670000000

8670520000	ZDK 4-2/D FORWARD	A.223
8670750000	ZDK 4-2	A.155
8670760000	ZAP/TW ZDK4-2	A.155
8670760000	ZAP/TW ZDK4-2	A.156
8670760000	ZAP/TW ZDK4-2	A.175
8670760000	ZAP/TW ZDK4-2	A.223
8670850000	ZDK 4-2 BL	A.155
8671050000	ZDK 4-2 PE	A.175
8671080000	ZDK 4-2 V	A.155
8671120000	ZDK 4-2/DU-PE	A.156

8700000000

8709760000	ZDK 4-2 EL	A.223
------------	------------	-------

8730000000

8731640000	WTR 2.5 BL	A.308
8731660000	WTR 2.5 STB2.3 BL	A.308
8731670000	WTR 2.5/O.TNHE STB2.3	A.308
8731700000	WTR 2.5/O.TNHE	A.308
8731710000	ZTR 2.5 BL	A.192
8731720000	ZTR 2.5/3AN	A.192
8731730000	ZTR 2.5/3AN BL	A.192

8810000000

Order No.	Type	Page
8817920000	ZTR 6-2 E / 24V UC	B.268
8817930000	ZTR 6-2 E / 230V UC	B.268

8870000000

8870840000	SRC1 QV P	B.216
8870840000	SRC1 QV P	B.217
8870840000	SRC1 QV P	B.218
8870840000	SRC1 QV P	B.219

9000000000

9006060000	SWIFTY SET	A.148
9006060000	SWIFTY SET	A.149
9006060000	SWIFTY SET	A.154
9006060000	SWIFTY SET	A.284
9006060000	SWIFTY SET	A.285
9006060000	SWIFTY SET	A.286
9006060000	SWIFTY SET	A.287
9006060000	SWIFTY SET	A.288
9006060000	SWIFTY SET	A.331
9006060000	SWIFTY SET	A.332
9006060000	SWIFTY SET	A.333
9006060000	SWIFTY SET	A.334
9006060000	SWIFTY SET	A.335
9006060000	SWIFTY SET	B.298
9006060000	SWIFTY SET	B.299
9006060000	SWIFTY SET	B.300
9006060000	SWIFTY SET	B.302
9006060000	SWIFTY SET	B.303
9008850000	SK WSD-S 1.5-10.0	B.38
9008850000	SK WSD-S 1.5-10.0	B.39
9008850000	SK WSD-S 1.5-10.0	B.42
9008850000	SK WSD-S 1.5-10.0	B.43
9008850000	SK WSD-S 1.5-10.0	B.46
9008850000	SK WSD-S 1.5-10.0	B.48
9008850000	SK WSD-S 1.5-10.0	B.66
9008850000	SK WSD-S 1.5-10.0	B.68
9008850000	SK WSD-S 1.5-10.0	B.69
9008850000	SK WSD-S 1.5-10.0	B.72
9008850000	SK WSD-S 1.5-10.0	B.73
9008850000	SK WSD-S 1.5-10.0	B.76
9008850000	SK WSD-S 1.5-10.0	B.78
9008850000	SK WSD-S 1.5-10.0	B.80
9008850000	SK WSD-S 1.5-10.0	B.82
9008850000	SK WSD-S 1.5-10.0	B.84
9008850000	SK WSD-S 1.5-10.0	B.86
9008850000	SK WSD-S 1.5-10.0	B.250
9008870000	SKS 2,0-8,0 MR	A.256
9008870000	SKS 2,0-8,0 MR	A.257
9008870000	SKS 2,0-8,0 MR	A.258
9008870000	SKS 2,0-8,0 MR	A.261
9008870000	SKS 2,0-8,0 MR	A.279
9008870000	SKS 2,0-8,0 MR	A.280
9008870000	SKS 2,0-8,0 MR	A.281
9008870000	SKS 2,0-8,0 MR	B.27
9008870000	SKS 2,0-8,0 MR	B.28
9008870000	SKS 2,0-8,0 MR	B.29
9008870000	SKS 2,0-8,0 MR	B.30
9008870000	SKS 2,0-8,0 MR	B.33
9008870000	SKS 2,0-8,0 MR	B.34
9008870000	SKS 2,0-8,0 MR	B.35
9008880000	TH-S 9-40	A.256
9008880000	TH-S 9-40	A.257
9008880000	TH-S 9-40	B.28
9008880000	TH-S 9-40	B.29

9010000000

9014840000	HTF ZRV	A.206
------------	---------	-------

9200000000

9201040000	HTF AFK 2.5	A.207
9201610000	WQV PEN 50N	A.279
9201610000	WQV PEN 50N	A.357
9201610000	WQV PEN 50N	B.33
9201630000	WQV PEN 95N/120N	A.280
9201630000	WQV PEN 95N/120N	A.357
9201630000	WQV PEN 95N/120N	B.34
9203060000	WDU 4 SL BL	A.247
9205270000	ZUB MULTIMETER	B.106
9205270000	ZUB MULTIMETER	B.107
9205270000	ZUB MULTIMETER	B.112
9205270000	ZUB MULTIMETER	B.113

9510000000

9512190000	WDU 70N/35	A.257
9512190000	WDU 70N/35	B.28
9512200000	WPE 70N/35	B.28
9512200000	WPE 70N/35	B.33
9512210000	WNT 70N/35	B.300
9512240000	WQV 70N/2	A.257
9512240000	WQV 70N/2	A.348
9512240000	WQV 70N/2	B.28
9512240000	WQV 70N/2	B.29
9512240000	WQV 70N/2	B.266
9512250000	WQV 70N/3	A.257

Order No.	Type	Page
9512250000	WQV 70N/3	A.348
9512250000	WQV 70N/3	B.28
9512250000	WQV 70N/3	B.29
9512250000	WQV 70N/3	B.266
9512260000	WAD 20 GE WSD	A.256
9512260000	WAD 20 GE WSD	A.257
9512260000	WAD 20 GE WSD	B.27
9512260000	WAD 20 GE WSD	B.28
9512260000	WAD 20 GE WSD	B.28
9512260000	WAD 20 GE WSD	B.29
9512260000	WAD 20 GE WSD	B.265
9512260000	WAD 20 GE WSD	B.266
9512420000	WDU 70N/35 BL	A.257
9512420000	WDU 70N/35 BL	B.28

9520000000

9525840000	WQV 70N-PEN	A.280
9525840000	WQV 70N-PEN	A.357
9525840000	WQV 70N-PEN	B.33

9530000000

9531290000	WQV 70N/4	A.257
9531290000	WQV 70N/4	A.348
9531290000	WQV 70N/4	B.28
9531290000	WQV 70N/4	B.29
9531290000	WQV 70N/4	B.266
9532440000	KDKS 1/35 DB	A.301
9532470000	AP KDKS1 DB	A.301
9532470000	AP KDKS1 DB	A.302
9537410000	WDU 10 SL/EN SW	A.251
9537440000	WDU 4 SL	A.247
9537450000	WDU 4 SL/EN	A.247
9537460000	WDU 6 SL	A.249
9537470000	WDU 6 SL/EN	A.249
9537480000	WDU 10 SL	A.251
9537490000	WDU 10 SL/EN	A.251
9537550000	SIHA 1/G20	A.309
9537550000	SIHA 1/G20	A.356
9537560000	SIHA 1/G20 10-36V	A.309
9537560000	SIHA 1/G20 10-36V	A.356
9537680000	SIHA STRAP	A.236
9537680000	SIHA STRAP	A.356
9538080000	WTL 6 SL/EN	B.174
9538080000	WTL 6 SL/EN	B.175
9538090000	WTD 6 SL	B.173
9538100000	WTD 6 SL/EN	B.174
9538100000	WTD 6 SL/EN	B.175
9538110000	WAP WTL6 SL	B.172
9538110000	WAP WTL6 SL	B.173
9538110000	WAP WTL6 SL	B.174
9538110000	WAP WTL6 SL	B.175

9540000000

9540000000	ZEW 35	A.128
9540000000	ZEW 35	A.129
9540000000	ZEW 35	A.130
9540000000	ZEW 35	A.131
9540000000	ZEW 35	A.132
9540000000	ZEW 35	A.133
9540000000	ZEW 35	A.134
9540000000	ZEW 35	A.135
9540000000	ZEW 35	A.136
9540000000	ZEW 35	A.138
9540000000	ZEW 35	A.139
9540000000	ZEW 35	A.140
9540000000	ZEW 35	A.141
9540000000	ZEW 35	A.142
9540000000	ZEW 35	A.143
9540000000	ZEW 35	A.144
9540000000	ZEW 35	A.145
9540000000	ZEW 35	A.146
9540000000	ZEW 35	A.147
9540000000	ZEW 35	A.148
9540000000	ZEW 35	A.149
9540000000	ZEW 35	A.151
9540000000	ZEW 35	A.152
9540000000	ZEW 35	A.153
9540000000	ZEW 35	A.154
9540000000	ZEW 35	A.155
9540000000	ZEW 35	A.156
9540000000	ZEW 35	A.157
9540000000	ZEW 35	A.158
9540000000	ZEW 35	A.159
9540000000	ZEW 35	A.161
9540000000	ZEW 35	A.162
9540000000	ZEW 35	A.163
9540000000	ZEW 35	A.164
9540000000	ZEW 35	A.165
9540000000	ZEW 35	A.166
9540000000	ZEW 35	A.167
9540000000	ZEW 35	A.168
95400000		

Addresses worldwide

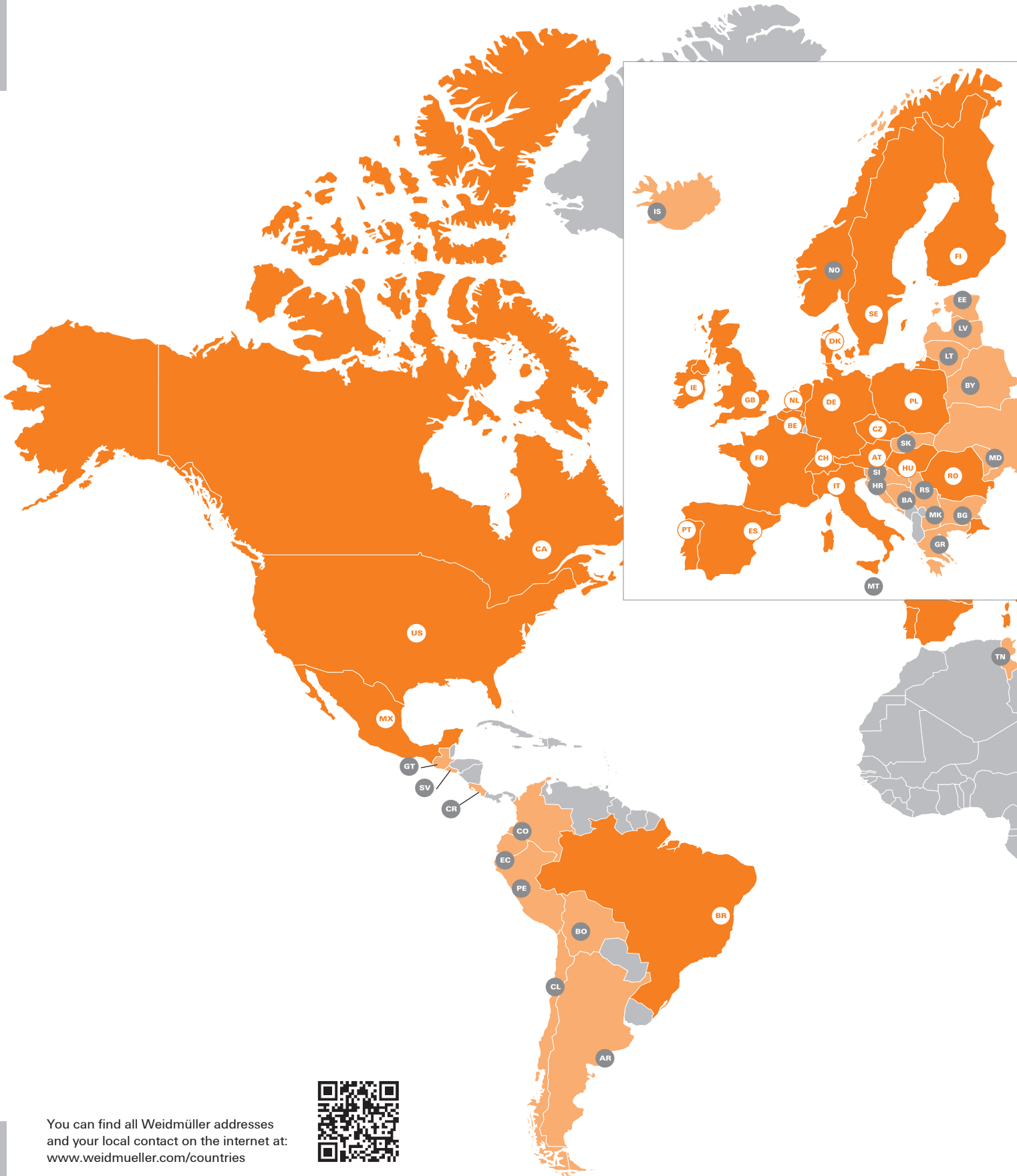

You can find all Weidmüller addresses and your local contact on the internet at: www.weidmueller.com/countries



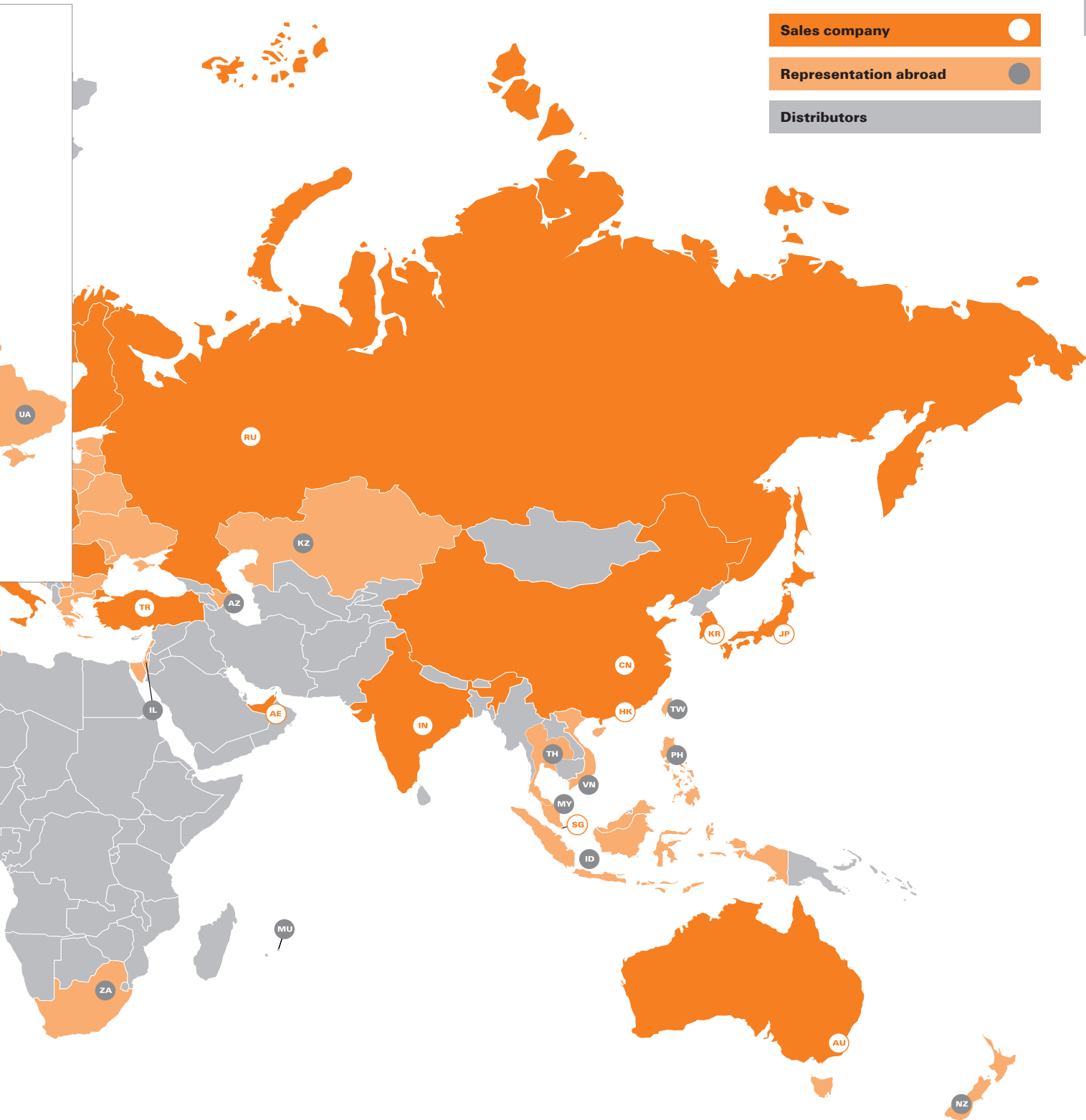

We cannot guarantee that there are no mistakes in the publications or software provided by us to the customer for the purpose of making orders. We try our best to quickly correct errors in our printed media.

All orders are based on our general terms of delivery, which can be reviewed on the websites of our group companies where you place your order. On demand we can also send the general terms of delivery to you.

Weidmüller – Your partner in Industrial Connectivity

As experienced experts we support our customers and partners around the world with products, solutions and services in the industrial environment of power, signal and data. We are at home in their industries and markets and know the technological challenges of tomorrow. We are therefore continuously developing innovative, sustainable and useful solutions for their individual needs. Together we set standards in Industrial Connectivity.

Weidmüller Interface GmbH & Co. KG
Klingenbergstraße 26
32758 Detmold, Germany
T +49 5231 14-0
F +49 5231 14-292083
www.weidmueller.com

Personal support can
be found on our website:
www.weidmueller.com/contact

Made in Germany



Order number: 2872690000/12/2022/SMD